



# Melixon-S



①



②



③





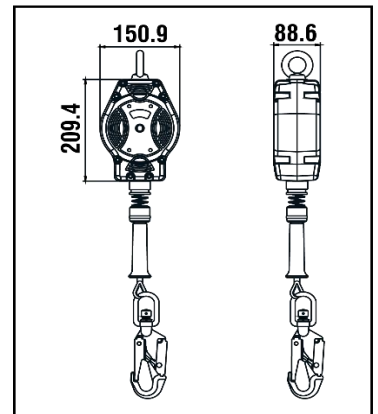
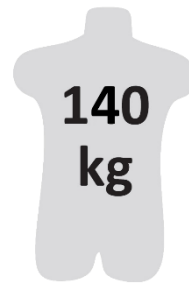

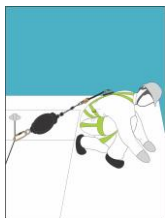
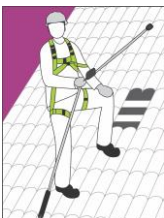

④



HS CODE
84798997

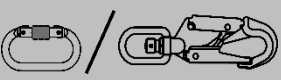



REF.	FA 20 402 07
LG.  KG	7 m
CE	EN 360:2002
MAT. 	Polyamide 6 - 30% fiber glass  STEEL Ø4.8 mm
	STEEL FA 50 101 17 / FA 50 203 20 with fall indicator
	x2
R(kN)	12 kN
	YES
+	PPE-R 11.060
	4.08 KG

LG.  
  
KG  
  
Length Max. user weight

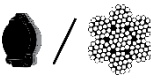
MAT.  
  
  
Material of casing / wire rope

  
  
Material of top connector / bottom connector

  
  
Number of swivels

  
  
Approved for work near sharp edges