



Melixon-S



①



②



③



④

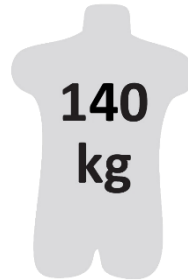



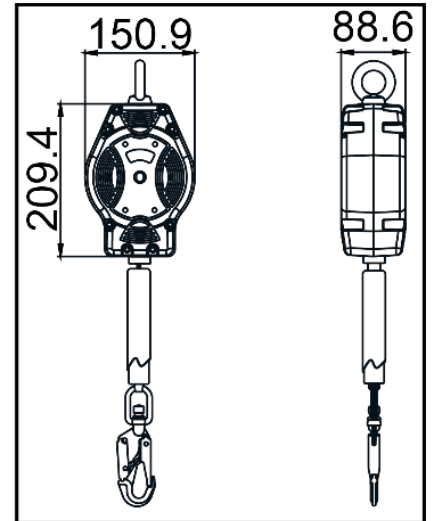



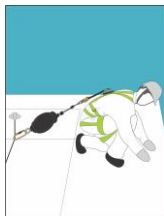
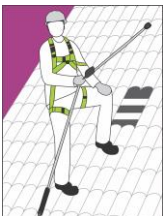

140
kg



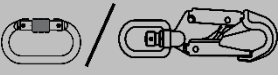

HS CODE
84798997





REF.	FA 20 504 06
 LG. KG	6 m
	EN 360:2002
 MAT.	Polyamide 6 - 30% fiber glass
	PES 25 mm
	 FA 50 101 17 / FA 50 203 20 with fall indicator
	x2
R(kN)	15 kN
	YES
	3.21 KG

 LG.
 KG
 Length Max. user weight



 MAT.
 Material of casing / webbing

 Material of top connector / bottom connector

 Number of swivels

 Approved for work near sharp edges