



Xelixon



①



②



③



④

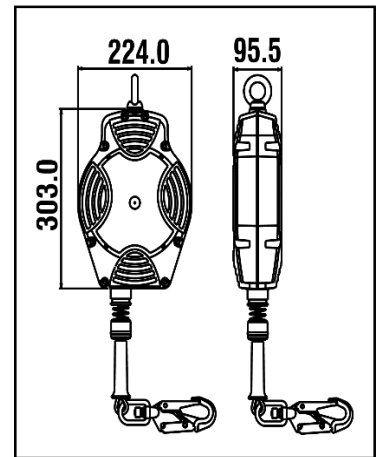



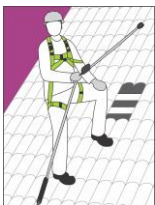







HS CODE
84798997







FA 20 402 15B, FA 20 402 20, FA 20 402 20S

REF.	FA 20 402 15B FA 20 402 20	FA 20 402 20S
LG.  KG	15 m 20 m	20 m
CE	EN 360:2002	EN 360:2002
MAT. 	Polyamide 6 - 30% fiber glass	Polyamide 6 - 30% fiber glass
	 STEEL Ø4.5 mm FA 50 101 17 / FA 50 203 20 with fall indicator	 INOX Ø4.5 mm FA 50 101 17 / stainless steel connector with fall indicator
	x2	x2
R(kN)	12 kN	12 kN
	NO	NO
+	 II 2 Exh IIC T6 Gb EN 360 §4.6 (endurance test)	 II 2 Exh IIC T6 Gb EN 360 §4.6 (endurance test)
	7.49 KG 7.70 KG	7.70 KG

 LG.
 KG
Length Max. user weight

MAT.

Material of casing / wire rope

Material of top connector / bottom connector

Number of swivels

Approved for work near sharp edges