

## Supply cable systems

The Yale festoon cable systems contain all the parts required to install your power cable supply.

### Features and benefits include:

- ✓ Galvanised track and supports.
- ✓ System lengths from 3 to 30mtr.
- ✓ Simple and quick to install.
- ✓ Supplied with flat form cable.

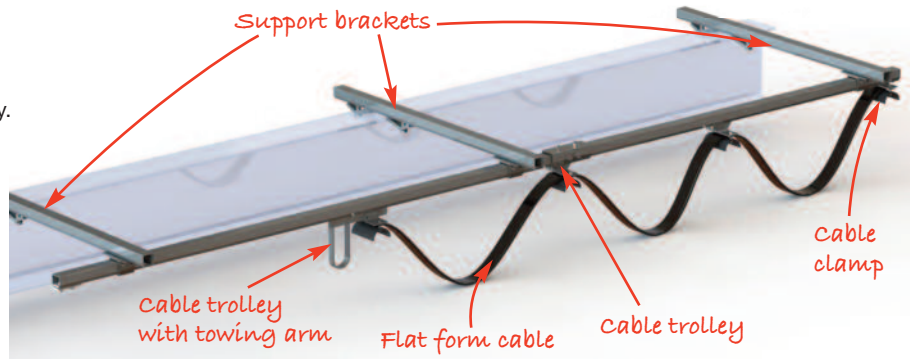

Description	Article number	Track length mtr	Flatform cable length mtr	Joints	Support brackets	End clamp	End stop	Cable trolley
Festoon Kit 3	192020326	3	6	0	3	1	1	2
Festoon Kit 6	N4300014474	6	10	1	5	1	1	3
Festoon Kit 9	N4300014475	9	13	2	7	1	1	5
Festoon Kit 12	N4300014476	12	16	3	9	1	1	7
Festoon Kit 15	N4300014477	15	20	4	11	1	1	9
Festoon Kit 18	N4300014478	18	23	5	13	1	1	11
Festoon Kit 21	N4300014479	21	26	6	15	1	1	13
Festoon Kit 24	N4300014480	24	30	7	17	1	1	15
Festoon Kit 27	N4300014481	27	33	8	19	1	1	17
Festoon Kit 30	N4300014482	30	36	9	21	1	1	19

*Stainless steel system is also available. Prices on request.*

Image for illustration purposes only

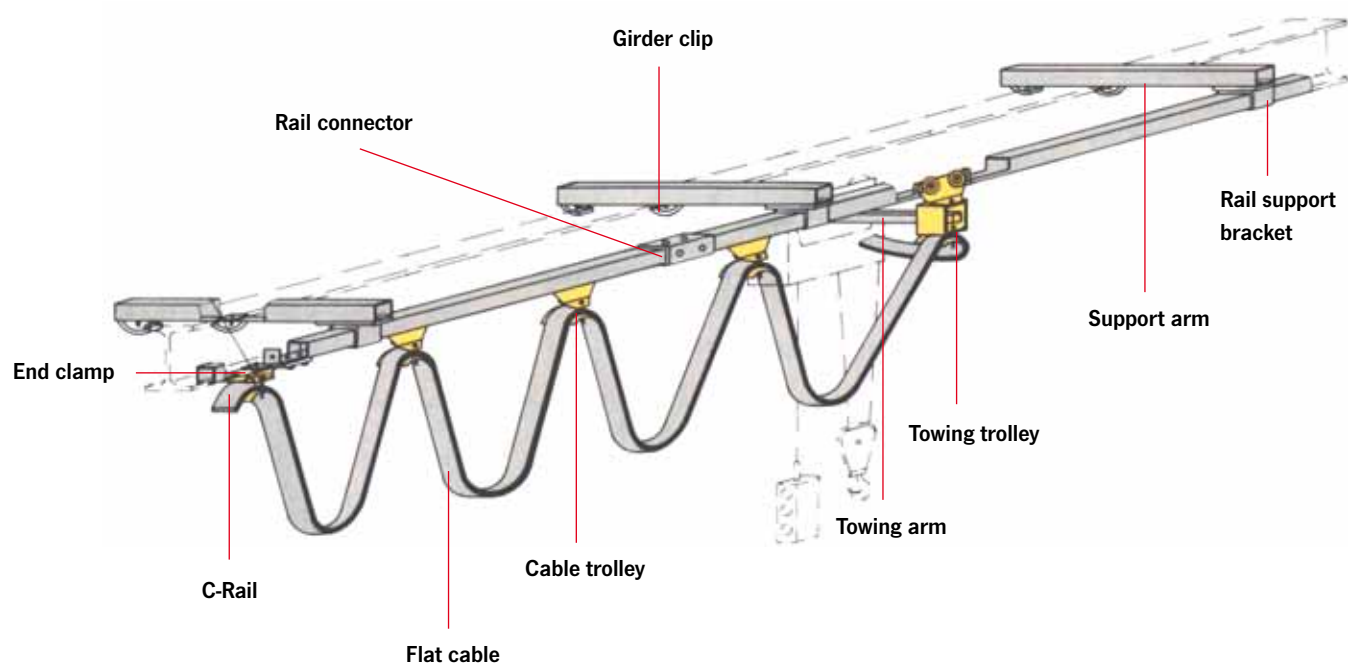



Cable trolley



Towing trolley



Rail support bracket



Rail connector



C-Rail

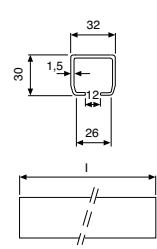
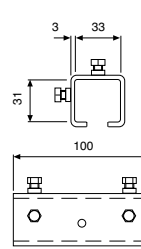
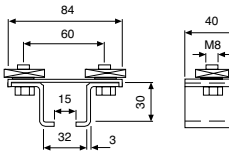
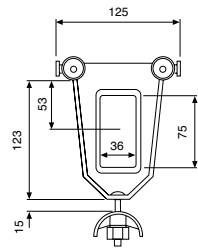
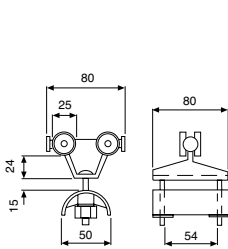

## INFO

Optional: Mounting kit consisting of support arm and girder clips for connection to the beam.

Special applications e.g. for curves or cable trolley for round cables on request.

