

# Micro Centrifuge

## Instruction manual

Catalog No. AB-MC12



[www.majorsci.com](http://www.majorsci.com)  
[service@majorsci.com](mailto:service@majorsci.com)

# Packing List

## AB-MC12

- 1x AB-MC12 Micro Centrifuge
- 1x Rotor
- 1x Rotor lid
- 1x Rotor nut
- 1x Adapter 120W
- 1x Operations Manual
- 1x Certification

Signed by:

Date:

**Major Science is liable for all missing or damaged parts / accessories within 7 days after customer received this instrument package. Please contact Major Science immediately regarding this issue. If no response within such time period from consignee party, that will be consignee party's whole responsibility.**

# Table of Contents



---

<b>PACKING LIST</b> .....	<b>2</b>
<b>WARNING</b> .....	<b>4</b>
<b>SECTION 1 INTRODUCTION</b> .....	<b>5</b>
1.1 FOREWORD .....	5
1.2 OPENING CHECK.....	5
1.3 OVERVIEW .....	6
<b>SECTION 2 TECHNICAL SPECIFICATION</b> .....	<b>7</b>
<b>SECTION 3 INSTALLATION INSTRUCTIONS</b> .....	<b>9</b>
<b>SECTION 4 OPERATION INSTRUCTIONS</b> .....	<b>10</b>
4.1 CONTROL ELEMENTS.....	10
4.2 ROTOR INSERTION AND REMOVAL.....	10
4.3 LOADING THE ROTOR.....	10
4.4 CENTRIFUGATION WITH A PRESET TIME .....	10
4.5 SHORT-SPIN CENTRIFUGATION.....	11
4.6 SWITCHING TO THE RCF DISPLAY .....	11
4.7 OPEN THE CENTRIFUGE IN THE EVENT OF A POWER FAILURE .....	11
<b>SECTION 5 TROUBLE SHOOTING AND MAINTENANCE</b> .....	<b>12</b>
MAINTENANCE.....	13
<b>SECTION 6 ORDERING INFORMATION</b> .....	<b>14</b>
<b>SECTION 7 ANNEX I</b> .....	<b>15</b>
<b>SECTION 8 WARRANTY</b> .....	<b>16</b>

# Warning

---

## Safety Precautions

	The rotor and the rotor lid must always be securely fastened. If the centrifuge makes unusual noises when started, the rotor or rotor lid is not fastened correctly. Switch the device off immediately by pressing "START/STOP" key.
	Do not use damaged rotors!
	Do not move the centrifuge during the run!

### 1 Place the tubes

- 1.1 A liquid density of 1.2g/ml must not be exceeded at the max. speed.
- 1.2 Damaged tubes can not be centrifuged. This is because broken tubes can, in addition to sample loss, result in further damage to the centrifuge.
- 1.3 Close the test tube lids before centrifuging. Open lids can be ripped off during centrifuging and damage the centrifuge.
- 1.4 Must load the test tubes symmetrically.

### 2 Maintenance of rotor

- 2.1 Even slight scratches and tears of the rotor can lead to serious internal material damage.
- 2.2 Avoid damage caused by aggressive chemicals, including among others: strong and weak alkali, strong acids.
- 2.3 In the event of contamination caused by aggressive agents, The rotor must be cleaned immediately using a neutral cleaning liquid.

# **Section I Introduction**

---

## **I.1 Foreword**

Thank you for purchasing our products: Micro Centrifuge, This Manual for users contains function and operation of the Instrument. In order to use the instrument properly, please read this manual carefully before using the Instrument.

## **I.2 Opening Check**

Please check the Instrument with the packing list when you first open the instrument packing case. If you find there is something wrong with the Instrument, do contact the vendor or the producer.

### **I.3 Overview**

This centrifuge designed for workstations in training and research laboratories in the fields of bioscience, medicine and chemistry. Twelve 1.5ml or 2.0ml micro test tubes can be centrifuged simultaneously in a 45° fixed-angle rotor.

Before starting up this centrifuge for the first time, please read the rest of this operations manual.



▲ Front view

## Section 2 Technical Specification

---

Model	AB-MC12
Power supply	110V-240V,50-60 Hz
Power	100W
Max. speed	14,500 rpm
Max. centrifugal force	14,000g
rpm/rcf	ok
Time	20sec ~ 99min
Max. load	12x1.5/2.0ml tubes
Max. permitted density	1.2g/ml
Acceleration time to max. speed	20 seconds
Braking time from max. speed	19 seconds
Ambient temperature	5°C ~ 35°C
Dimensions (WxDxH)	212mmx240mmx138mm
Weight (with rotor)	4.1kg

## Structure Description

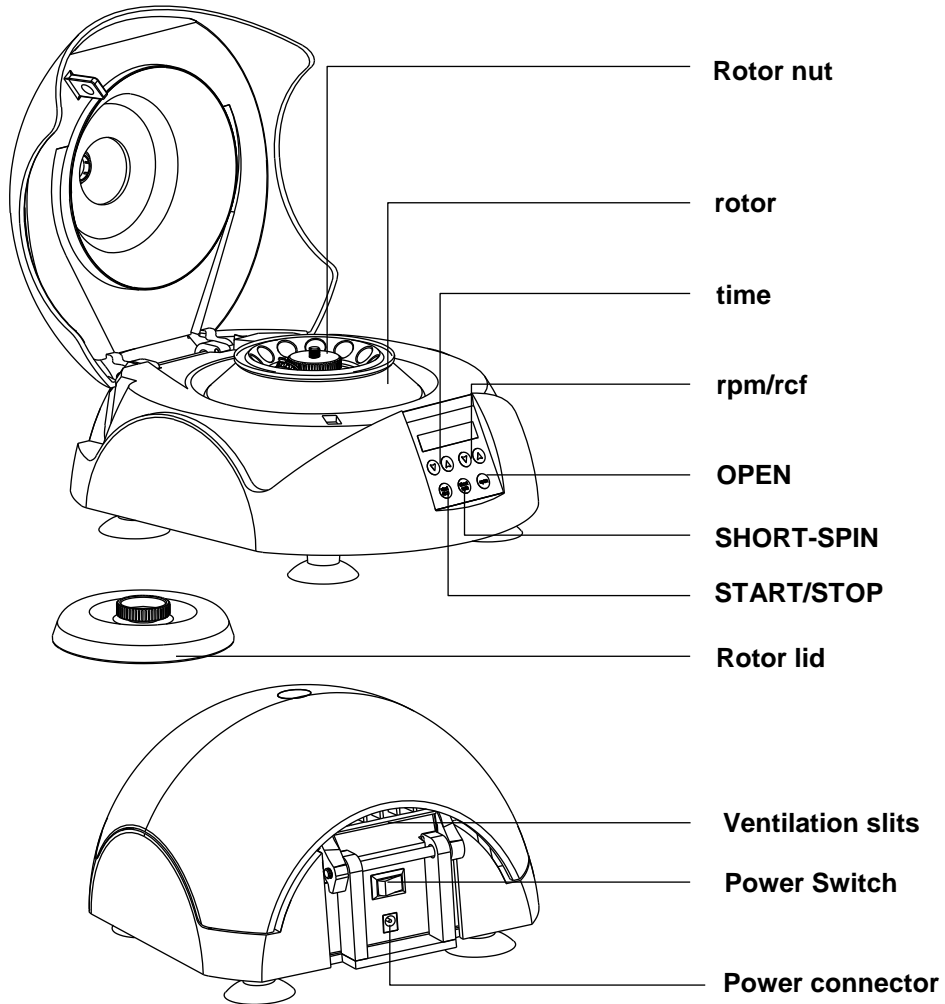



## Section 3 Installation Instructions

---

3.1 Place the centrifuge onto a level, horizontal surface. Make sure that the ventilation slits are not blocked.

3.2 Insert the column connector of the adapter to power connector of the device and insert another connector of the adapter to mains power supply.

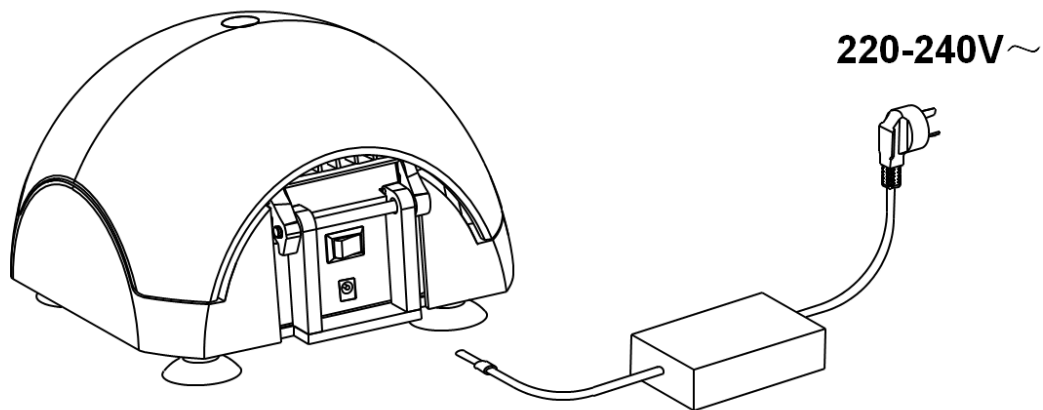

3.3 A safety distance of 30 cm should be observed around the centrifuge during operation. No objects which could cause additional damage in the event of a centrifuge crash should be positioned in this space.

3.4 Power on the main switch. The centrifuge is ready to operate when the display becomes visible. Place the rotor onto the rotor axle and tighten using the rotor nut.

Before starting up the centrifuge for the first time, make sure the rotor nut is securely fastened.

# Section 4 Operation Instructions

---

## 4.1 Control elements

**START/STOP**----for start or stop centrifugation

**SHORT-SPIN**----for reduced-time centrifugation

**OPEN**-----to open the lid

**▲▼** -----for setting the time and speed

## 4.2 Rotor insertion and removal

Fit the rotor onto the motor shaft, followed by the rotor nut. Tighten the rotor nut by turning clockwise. To release the rotor, turn the rotor nut counterclockwise.

Before each start, check that the rotor is firmly tightened!

## 4.3 Loading the rotor

Rotor must always be loaded symmetrically. Minimize differences in weight between the filled sample tubes-taring with a scale is recommended. This will reduce wear on the drive and cut running noise

## 4.4 Centrifugation with a preset time

4.4.1 Turn on the mains switch, pressing “OPEN” to open the lid, load the rotor symmetrically. Fasten the rotor lid and close the centrifuge lid.

4.4.2 Pressing Time’s ▼▲change the run time, the time can be pre-selected between 20 seconds and 99minutes, and pressing speed’s ▼▲ to change the run speed, the max. speed is 13,400rpm.

4.4.3 Pressing the first “START/STOP” to start the run. Pressing the second “START/STOP” to end the run prematurely. The remaining run time appears in the display.

After the run, the lid lock of centrifuge opens automatically.

The time setting and the rotational speed may be changed during the run. The remaining run time appears in the display.

## 4.5 Short-spin centrifugation

4.5.1 Turn on the mains switch, pressing "OPEN" to open the lid, load the rotor symmetrically. Fasten the rotor lid and close the centrifuge lid.

4.5.2 Pressing "SHORT-SPIN". Short-spin centrifugation is possible for as long as this key is held down. The maximum rpm is 13400.

## 4.6 Switching to the rcf display

Pressing speed's ▲▼ simultaneously · the display switches from rpm to rcf.

Also pressing speed's ▲▼ simultaneously again, the display switches from rcf to rpm.

You can calculate with the following formula :

$$rcf = 1118 * 10^{-5} * n^2 * r_{max}$$

n: rotational speed in 1/min

$r_{max}$  = 6 cm, max. centrifuging radius in cm

## 4.7 Open the centrifuge in the event of a power failure

Disconnect the centrifuge from the mains supply. Wait until the rotor has come to a standstill, Then left up the device, remove the lock pole to right, the lid lock will be opened.

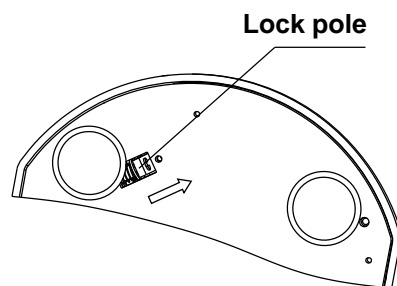

## Section 5 Troubleshooting and Maintenance

---



Many operating problems may be solved by carefully reading and following the instructions in this manual accordingly. Some suggestions for troubleshooting are given below. Should these suggestions not resolve the problem, contact our SERVICE DEPARTMENT or a distributor in your region for assistance. If troubleshooting service is required, please include a full description of the problem.

Error	Cause	Solution
No display	No main power connection. Power failure.	Plug in mains cable on both sides. Check the mains fuse.
Lid can't be opened.	Power failure. Rotor is still spinning. Lid lock failure.	Emergency lid release (see sec.4.7). Stop centrifuge run. Contact service.
Centrifuge shakes during acceleration	Rotor not loaded symmetrically.	Stop centrifuge run and load centrifuge symmetrically.
Er=01	Open lock failure	Contact service.
Er=02	Close lock failure	Contact service.
Er=08	Motor failure	Contact service.

### Encountering Problems

1. Check the troubleshooting section.
2. Call Technical Service or e-mail to [service@majorsci.com](mailto:service@majorsci.com)
3. If the unit must be shipped back for repair, contact Major Science or the distributor for a Return Material Authorization number and shipping instructions. The unit will be repaired and returned to you as quickly as possible.

## Maintenance

	The rotor and the outside of centrifuge should be cleaned regularly with a moist cloth. Disconnect the centrifuge from the mains supply, remove the rotor and clean it separately. Only neutral agents may be used for cleaning.
	Please check the rotor and especially the rotor bores regularly for deposits or damage, then reinsert the rotor and tighten the rotor nut.

## Section 6 Ordering Information

---

Cat. No.	Description
AB-MC12-110	AradyBio Mini Centrifuge, 12 x 0.5ml-2ml rotor capacity, with 110V power cord
AB-MC12-220	AradyBio Mini Centrifuge, 12 x 0.5ml-2ml rotor capacity, with 220V power cord

# Section 7 Annex I

---

## Wiring Diagram for Centrifuge

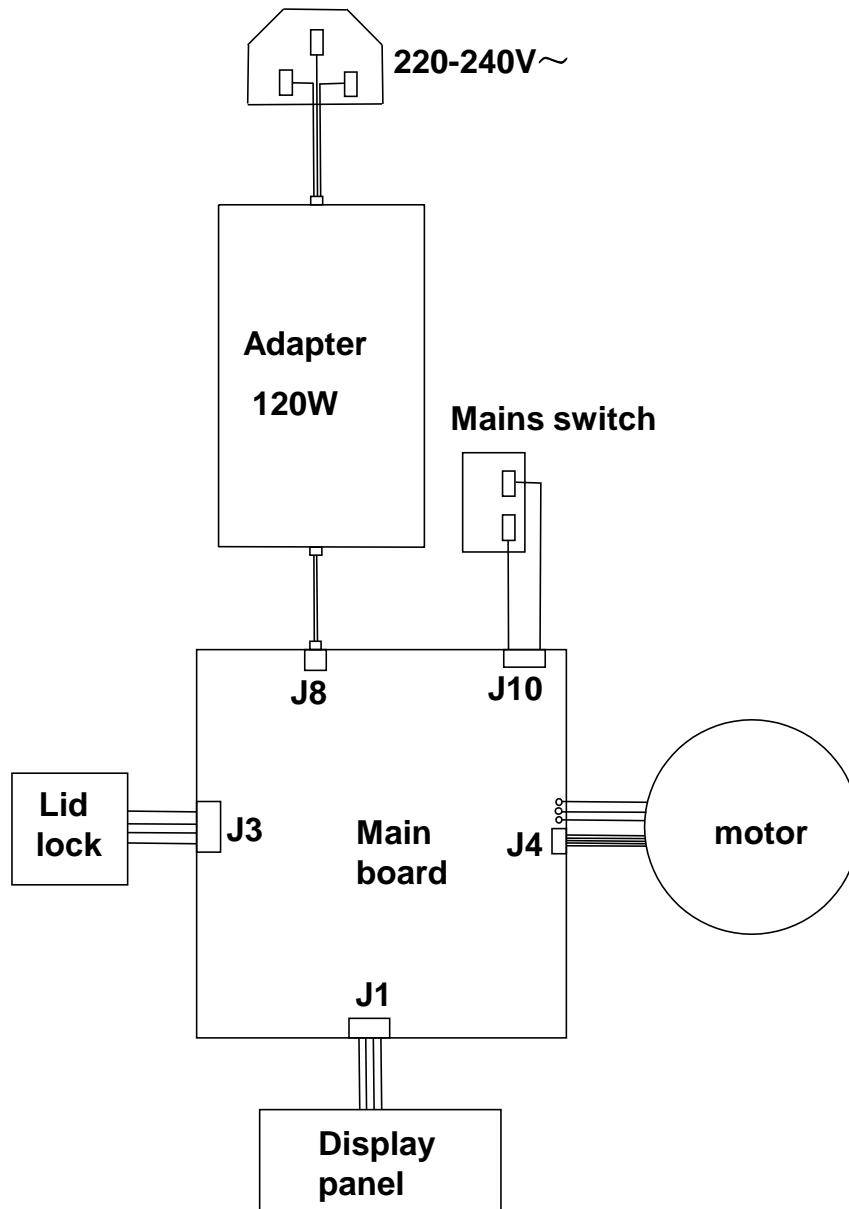

## **Section 8    Warranty**

---

The centrifuge and rotor are covered by a one-year warranty. This warranty covers the centrifuge and rotor. This warranty is void in the event of incorrect operation, use of nonstandard spare parts or accessories and unauthorized modification of the rotor or centrifuge. The rotor warranty does not cover normal wear and tear or damage and /or wakening caused by radioactive contamination, cleaning agents, or over tightening of the all en screw. Fuses are not covered by the warranty.

**Distributed:**

Major Science Co., Ltd.

**Address:**

No.19, Ln. 207, Huakang St.,  
Bade Dist., Taoyuan City 33464  
Taiwan(R.O.C.)

T/ 886-3-362-3319

F/ 886-3-362-3133

**Contact Information**

**Address**

19959 Sea Gull Way  
Saratoga, CA 95070  
U.S.A

T/ 1-408-366-9866

F/ 1-408-446-1107