

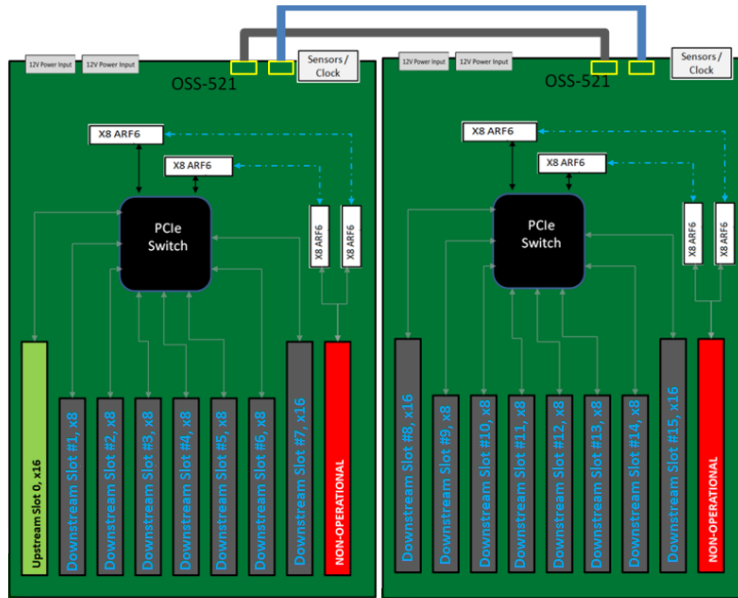

OSS-521 Gen4 Backplane



INSTALLATION GUIDE

OSS-521 Daisy-Chain Configuration



OSS
ONE STOP SYSTEMS

Table of Contents

1	Hardware Requirements	3
2	Setup / Installation	3
2.1	Set Backplane's Dipswitches	3
2.2	Connect ARC Cables	4
2.3	Connect Power Cables	7
3	Install Adapter Card.....	8
3.1	Set Target Card Dipswitches	8
3.2	Set Host Card Dipswitches (x16)	8
3.3	Install Target Card.....	8
3.4	Host Card Installation	9
4	Cable Installation	10
	Connect Mini-SAS HD SFF-8644.....	10
5	Complete Setup.....	11
6	Powering UP the Unit.....	12
7	Hardware Check	12
7.1	Verify Backplane LEDs	12
7.2	Verify Adapter Card LEDs.....	12
8	How to Get More Help	14
8.1	Contacting Technical Support.....	14
8.2	Returning Merchandise.....	14
8.3	Third Party Hardware & Software Support Policy	14
8.4	Online Support Resources	14

1 Hardware Requirements

1. Two OSS-521 Backplanes
2. Two 12in ARC cables

Two 12in long ARC cables and two OSS-521 backplanes

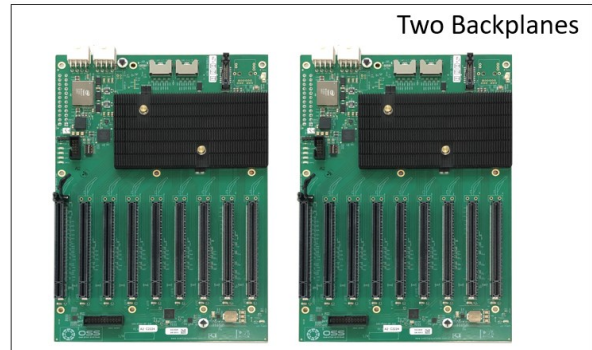

2 Setup / Installation

2.1 Set Backplane's Dipswitches

Set the Dipswitches on each backplane appropriately. Refer to the photos below for the corresponding dipswitch settings for each backplane (backplane #1 and backplane #2).

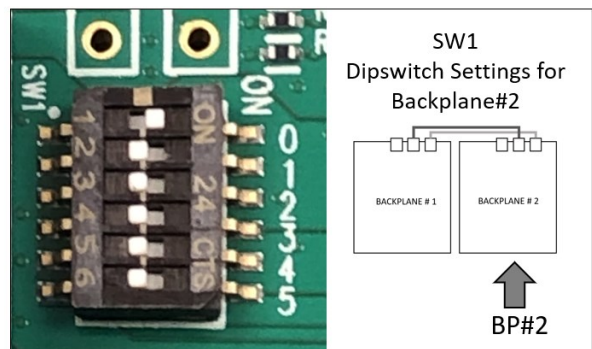
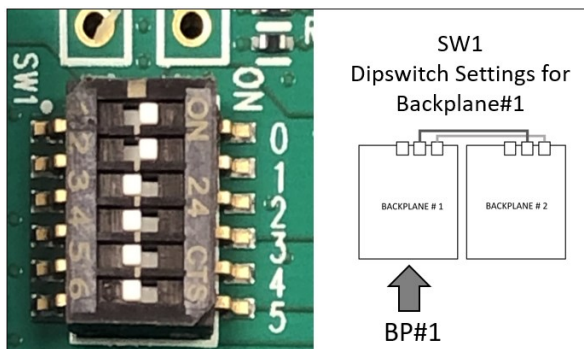

2.2 Connect ARC Cables

Connect the 1st ARC cable to port LANES 0-7 (from backplane #1 to backplane #2). Follow the diagram below for connecting the Arc cable.

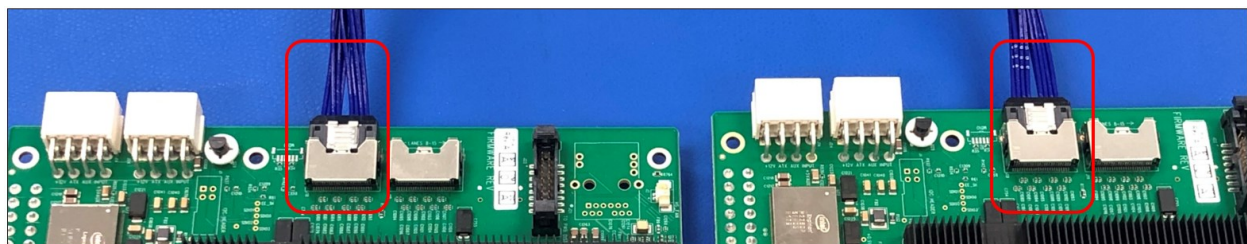
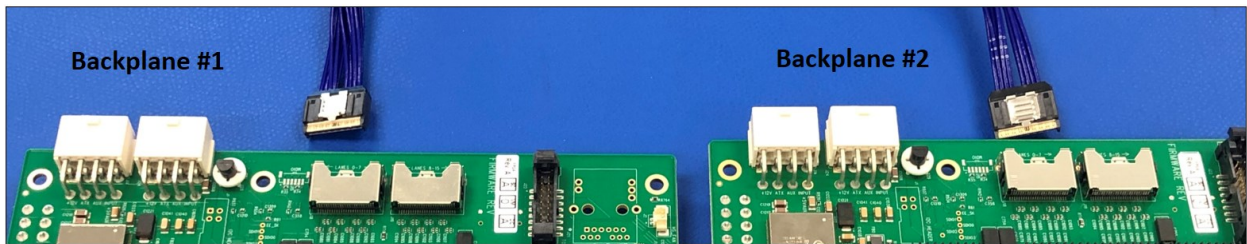
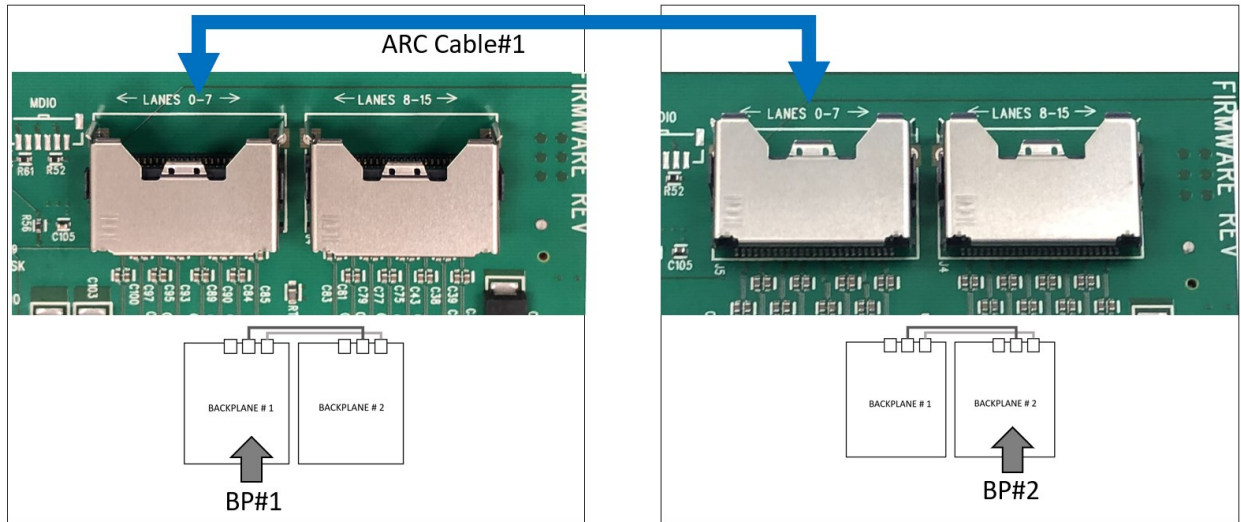

Connect the 2nd ARC cable to port LANES 8-15 (from backplane #1 to backplane #2). Follow the diagram below for connecting the Arc cable.

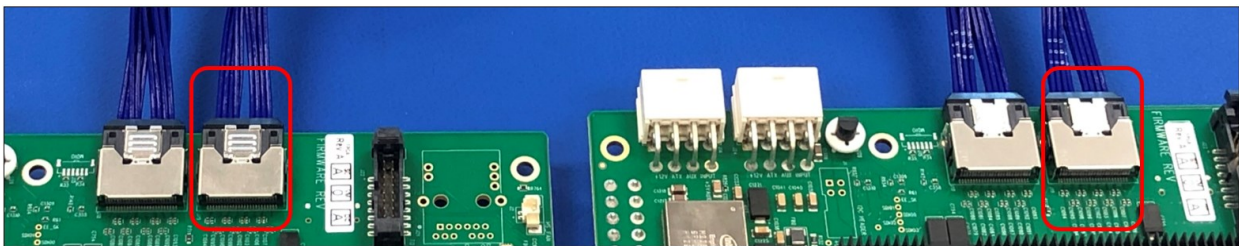
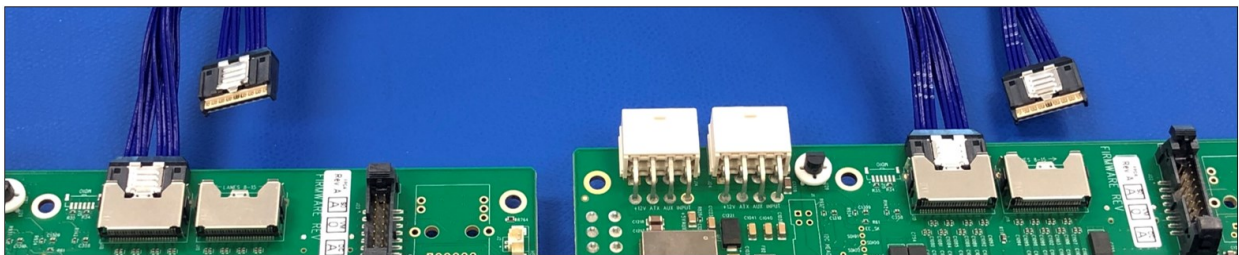
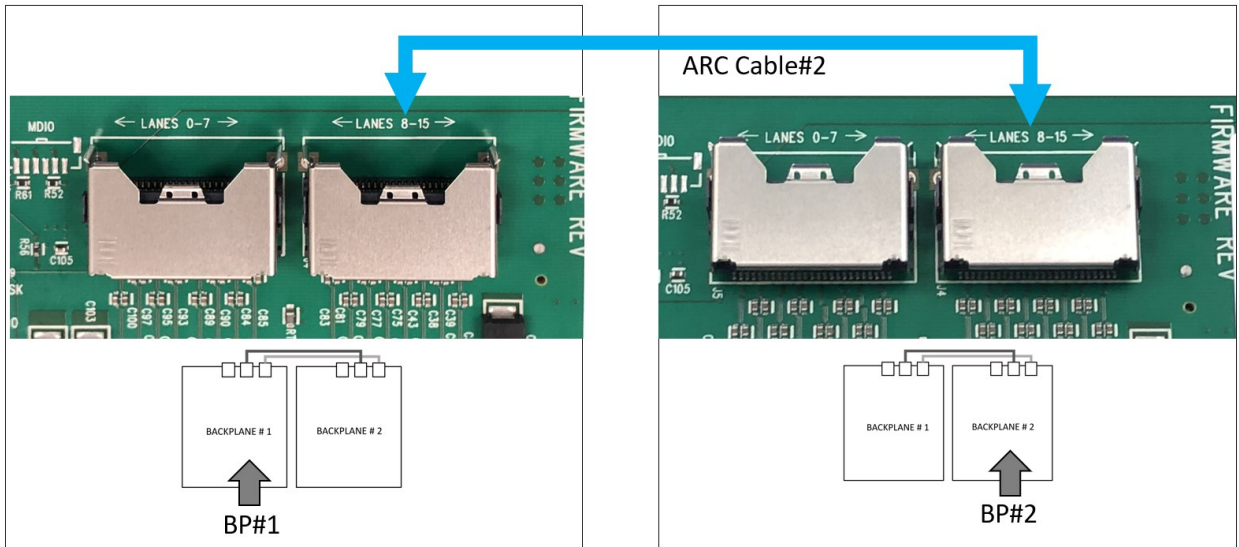

Below is the full diagram with two ARC cables connected between two OSS-521 backplanes and with the correct dipswitch settings.

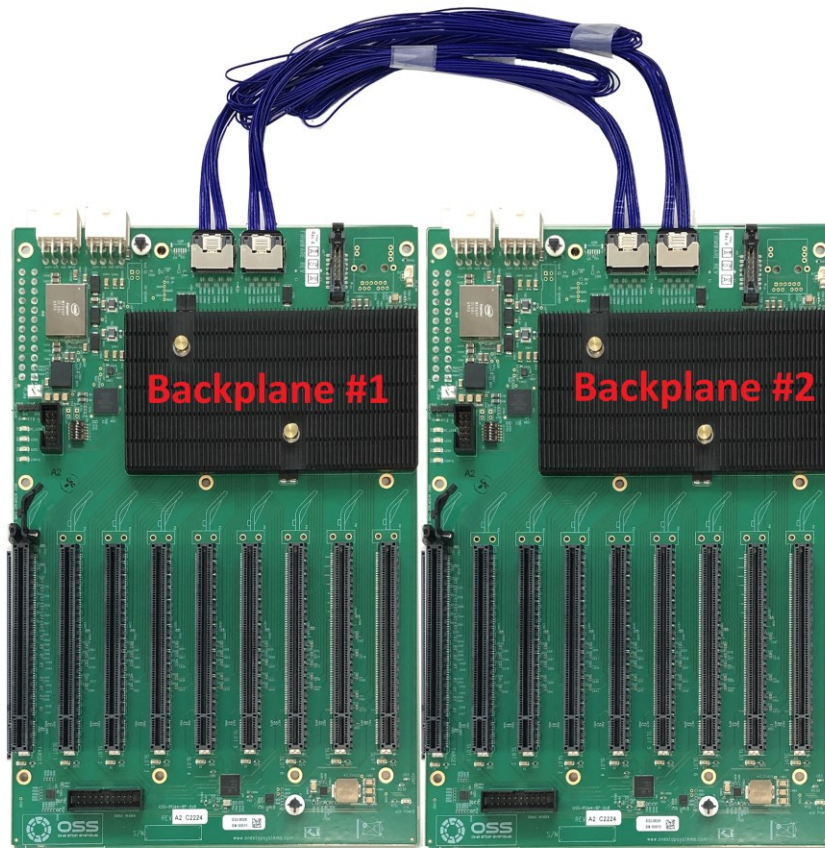
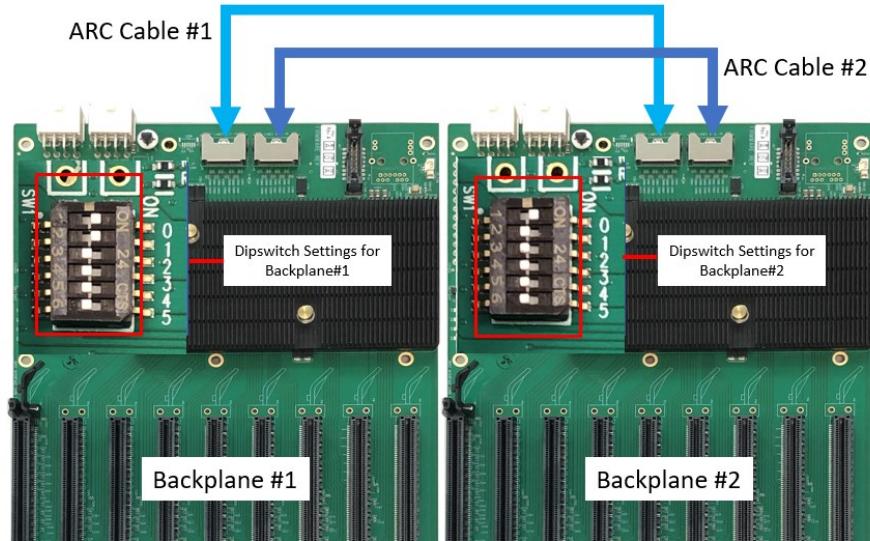

2.3 Connect Power Cables

Connect the ATX power cable to the onboard 24-PIN ATX power connector as shown from the photos below.

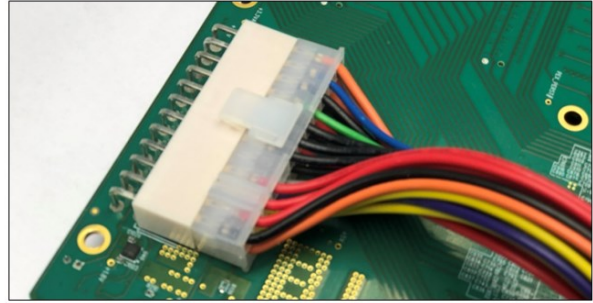
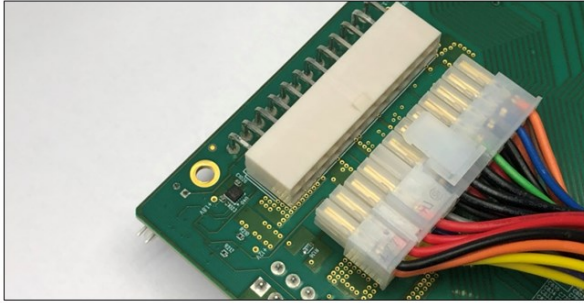

Connect the 12v Aux power cables to the 12V input connectors.

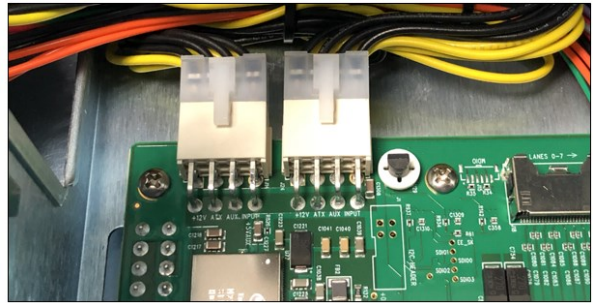

3 Install Adapter Card

3.1 Set Target Card Dipswitches

Using Gen4 adapter card, set the dipswitches on the card to target mode, see photo below for correct settings.

- SW1 #1 = ON; SW1 #2= ON
- SW2 = All OFF

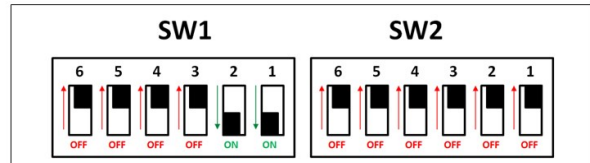
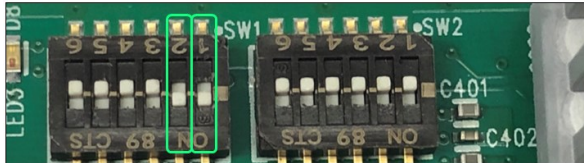

3.2 Set Host Card Dipswitches (x16)

Using Gen4 adapter card, set the dipswitches on the card to x16 host mode, see photo below.

- SW1 #2 = ON; #5 =ON.
- SW2 #1 = ON; #2 = ON

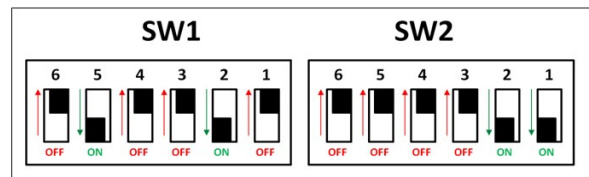
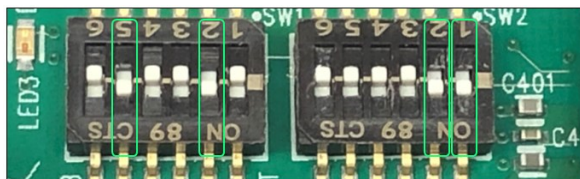

Note: For more information on different host card dipswitch settings / configurations please check the OSS-PCIe-HIB616-x16 installation guide.

3.3 Install Target Card

Plugin the target card in the upstream slot0 on the backplane #1.

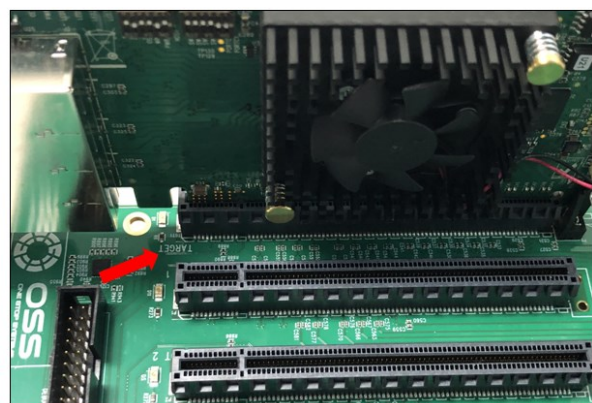
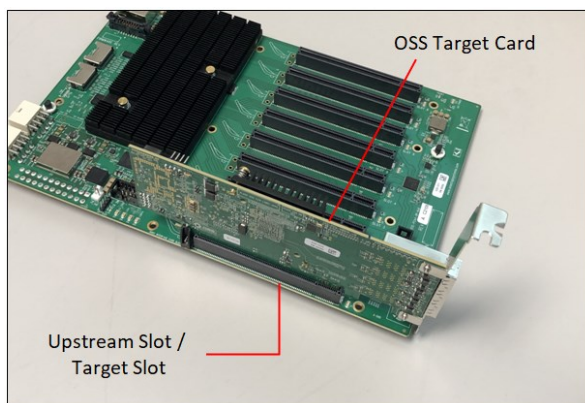

3.4 Host Card Installation

The host card can only be installed in the computer motherboard's PCIe slot. Install the Host card in an x16 Gen4 slot.

Align the host card PCIe connector on top of the PCIe slot. Carefully push the card down until it is firmly seated and secure it.

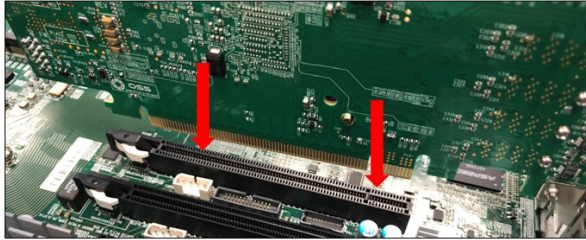

The photos below are example of x16 PCIe slot.

- For easy identification on the PCIe slot specification check the label or silk-screen next to the connector.

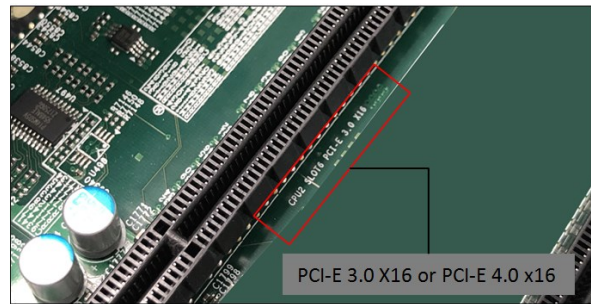

4 Cable Installation

Connect Mini-SAS HD SFF-8644

x16 cable configuration: cables Use four	x8 cable configuration: Use two cables	x4 cable configuration: One cable only
---	---	---

Note: Ensure the HIB616-x16 host card is set to x16 configuration, see x16 switch settings. Refer to the OSS-PCIe-HIB616-x16 installation guide.

- Plug-in the 1st cable to Port#0 (Top port) on both Target and Host cards
- Plug-in the 2nd cable to Port#1 on both Target and Host cards
- Plug-in the 3rd cable to Port#2 on both Target and Host cards
- Plug-in the 4th cable to Port#3 (Bottom port) on both Target and Host cards

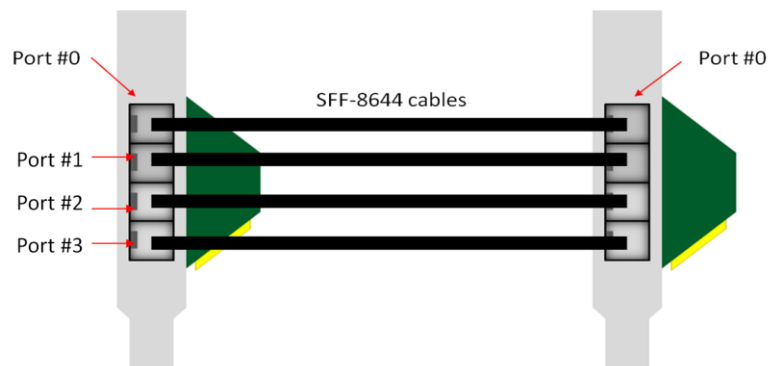

For more details on different cable configurations please refer to the OSS-PCIe-HIB616-x16 installation guide.

<https://www.onestopsystems.com/product/pcie-x16-gen-4-cable-adapter>

5 Complete Setup

Below diagram is the completed hardware setup. Host computer is linked to the daisy-chained OSS expansion boards.

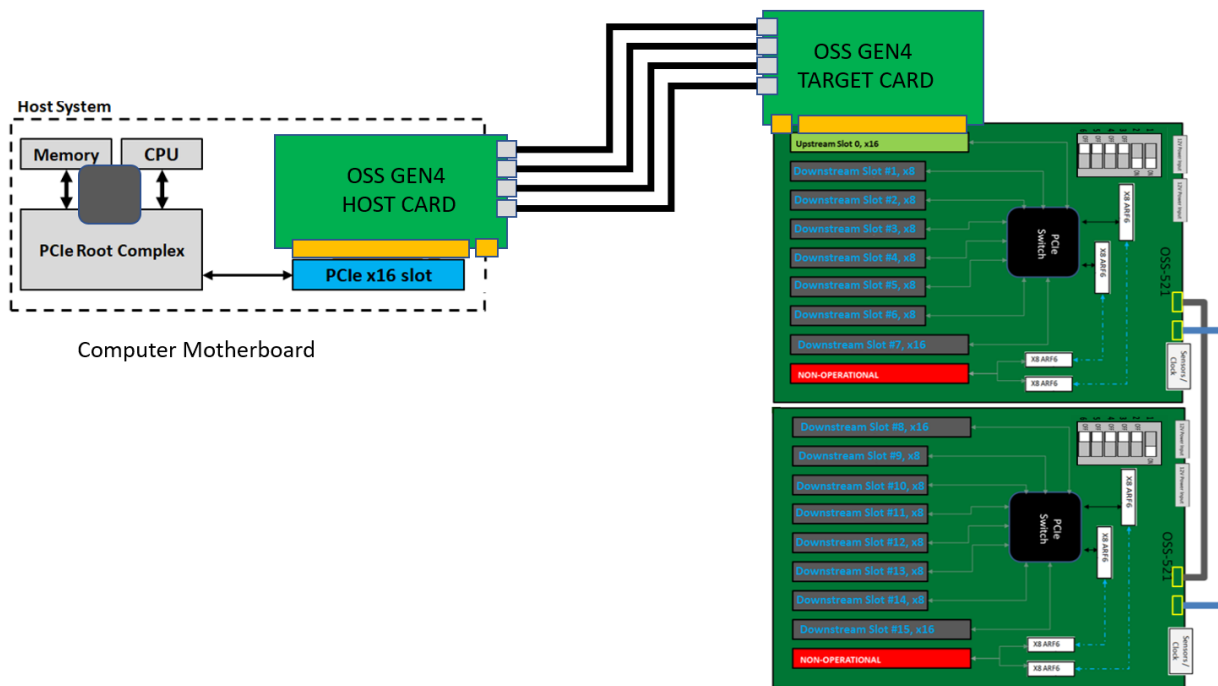

6 Powering UP the Unit

- Power ON the Gen5 backplane first.
- Turn ON the host computer.

7 Hardware Check

7.1 Verify Backplane LEDs

The Target SLOT LED on the backplane will illuminate as solid green.

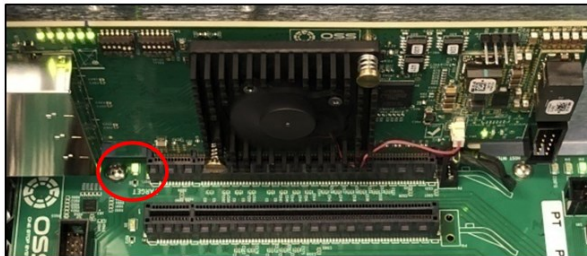

7.2 Verify Adapter Card LEDs

After powering ON the host computer, it will power UP the target device, the LINK LEDs on both host and target cards will illuminate. An operational adapter cards will illuminate the following LEDs (on both Host and Target cards).

D11	CE (Card edge)	Solid green
D10	PWR (Power)	Blinking green
D2	LED 0	Solid green
D4	LED1	Solid green
D6	LED2	Solid green
D8	LED3	Solid green
CHO	Link LED	Solid green
C9	Aux Power	Solid green

x16 configuration (Four x4 Cables connected)

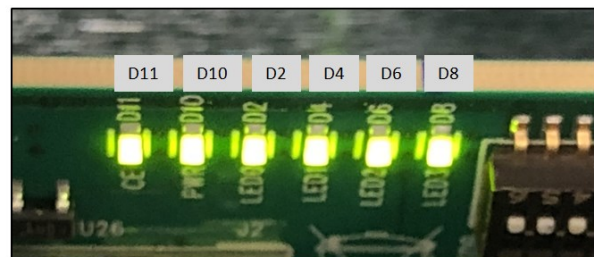
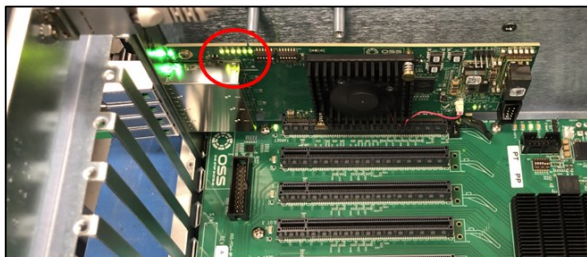

CHO LED will illuminate as solid green, indicates of a stable LINK between Target and Host cards.



When there is no link between Target and Host cards, the CHO LED is OFF.



The C9-Aux power LED will illuminate as solid green, which is an indication of power is present on the card.

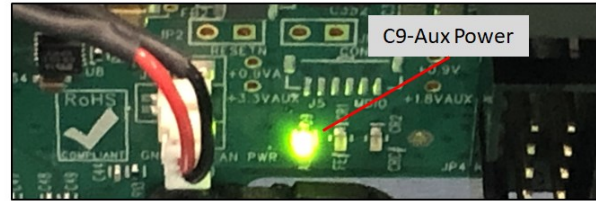
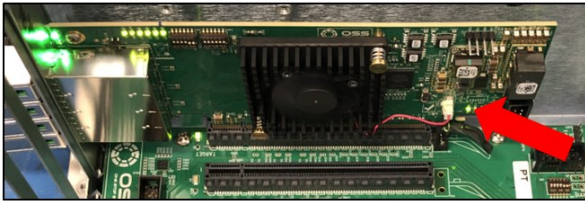

8 How to Get More Help

8.1 Contacting Technical Support

Our support department can be reached by phone at [1 \(760\) 745-9883](tel:7607459883). Support is available Monday through Friday, 8:00 AM to 5:00 PM PT. When contacting Technical Support make sure to include the following information:

1. Exact and correct serial #
2. Service Ticket or Case # (if you already submitted an online request)
3. Computer Type & Model: Operating System
4. Make & Model of PCI/PCIe cards: Application
5. Problem description

When submitting an online technical support request always provide a valid working e-mail address, phone number, shipping address and proper contact name. Check your e-mail for an automated response containing the case # and updates. You can also visit our web site at this address <https://www.onestopsystems.com> for a quick response, use the Technical Support and RMA Request Form available in the Support Section of the website. Simply complete the form with all required information. Please make sure that your problem description is sufficiently detailed to help us understand your problem.

Shipping or Transporting of Expansion Unit with PCI / PCIe cards.

Any PCIe cards in **should be removed** (or not to be installed) prior to shipment to avoid or prevent damage. Note: Expansion board and PCIe / PCI cards that arrive damaged in shipment will not be covered under warranty.

8.2 Returning Merchandise

If factory service is required, a Service Representative will give you a Return Merchandise Authorization (RMA) number. Put this number and your return address on the shipping label when you return the item(s) for service. Please note that One Stop Systems WILL NOT accept COD packages, so be sure to return the product freight and duties paid. Ship the well-packaged product to the address below:

Attention: RMA # _____, One Stop Systems
2235 Enterprise Street, #110
Escondido, CA 92029
USA

It is not required, though highly recommended, that you keep the packaging from the original shipment of your product. However, if you return a product for warranty repair/ replacement or take advantage of the 30-day money back guarantee, you will need to package the product in a manner similar to the manner in which it was received from our plant. We cannot be responsible for any physical damage to the product or component pieces of the product (such as the host or expansion interfaces for the expansion chassis) that are damaged due to inadequate packing. Physical damage sustained in such a situation will be repaired at the owner's expense in accordance with Out of Warranty Procedures. Please, protect your investment, a bit more padding in a good box will go a long way to ensuring the device is returned to use in the same condition you shipped it in. Please call for an RMA number first.

8.3 Third Party Hardware & Software Support Policy

OSS evaluates, certifies, and bundles many popular third-party hardware and software products with OSS hardware for ease of use and guaranteed operation. OSS encourages customer innovation by combining OSS products in new and interesting ways with third party and customer developed hardware and software. Unfortunately, with infinite combinations of hardware and software, OSS cannot assess and validate every configuration. OSS is committed to supporting its products and identifying if any technical issue may be related to third-party hardware or software. To isolate technical issues, OSS may request that the system be returned to the same configuration that shipped from the OSS factory and any non-OSS supplied third-party hardware or software be removed from the system during troubleshooting.

We assess, certify, and support many third-party hardware and software products along with OSS hardware and are happy to integrate a fully supported system. Ask us about that service and we would be happy to help. If an OSS product is fully functional and a support issue is related to third-party hardware or software that did not ship from the OSS factory, the customer requesting support should reach out to the third-party vendor for assistance to fully troubleshoot the issue.

8.4 Online Support Resources

As a product user and customer, listed below are our Online Support Resources

<https://www.onestopsystems.com/support> provides Knowledgebase Articles such as troubleshooting methods, compatibility, FAQ, documentation, and product technical information. If you need technical support, product assistance or have a technical inquiry we encourage you to submit it on-line using our Technical Support Form. If you need to send a unit for repair or diagnostic evaluation, fill out our RMA (Return Material Authorization) online request form.



2235 Enterprise Street, Suite#110, Escondido CA 92029

Toll-Free : +1(800)285-8900 US • Main: +1 (760) 745-9883 • Fax: +1 (760) 745-9824

www.onestopsystems.com