



Quick Start Guide

Block Diagram

Two backplanes configured in a daisy chain expansion mode.
Four SFF-8644 cables are linked between Host and Target cards.

- 1 Upstream Slot
- 9 Downstream slots
- 2 Non-operational slots

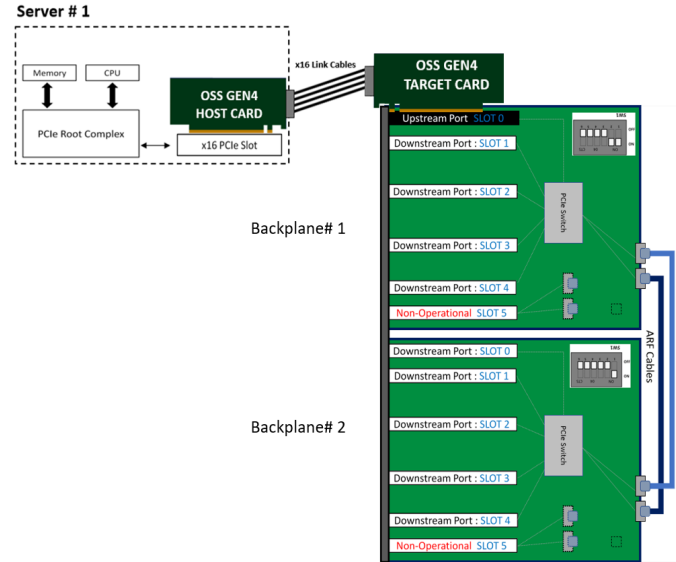

1

Install Host & Target Cards

Turn Off computer. Plug in the host card in the host computer.



The Target card is installed in SLOT#0 of backplane #1. See photo on the right.

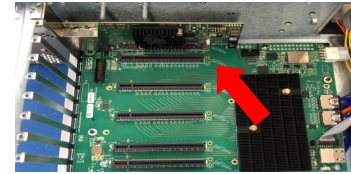

4

Connect Link Cables to Target Card

Connect all four SFF-8644 Cables to Target card.



5

Connect Link Cables to Host Card

Connect the other end of the cables to the Host card.



6

Set Host & Target Card Switches

Check Host card dipswitches are set to Host mode x16. See photo below.



Check Target card dipswitches are set to target mode. See photo on the right for correct switch settings.

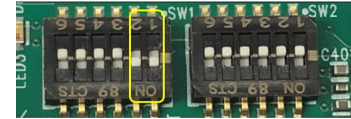

3

Cable Diagram

Cable diagram below shows how to connect all four SFF-8644 cables between Host and Target cards.

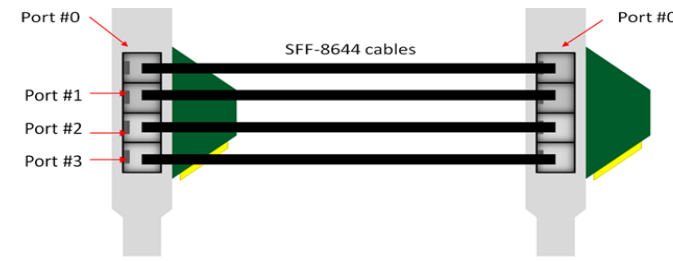

7

IPMI Connection

If equipped, connect Ethernet cable to either front or back RJ45 port. You can only use one or the other. You must plug-in the Ethernet cable first before you connect the power to the unit.

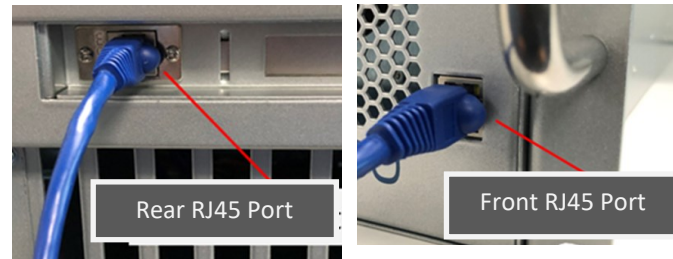

8

Apply Power

Connect all available power cables to the power supplies. The expansion unit will power UP instantly.

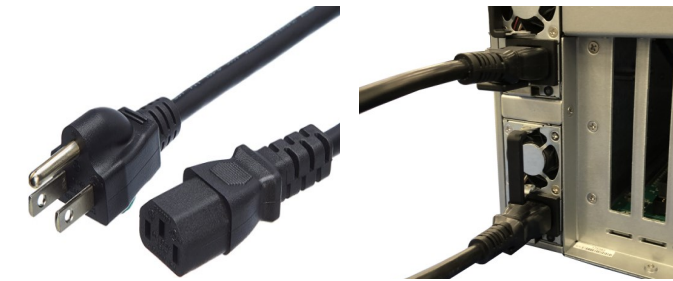

9

Power UP Computer

Connect power cable(s) to the computer. Upon powering UP the computer, it will initialize a link between host and target.



10

Power Supply and Front LEDs

The following LEDs will illuminate when the expansion unit is fully powered up and initialized.

1. PSU Good: solid green.
2. OSS logo: solid blue.
3. STANDBY / MAIN PWR: solid-green.
4. IPMI : solid green (if equipped).



11

Verify Host and Target Card Link LEDs

Verify and check that there is a stable link between Host and Target cards. Both cards will illuminate the following board LEDs when linked @ x16. The LINK LED will illuminate as solid green.

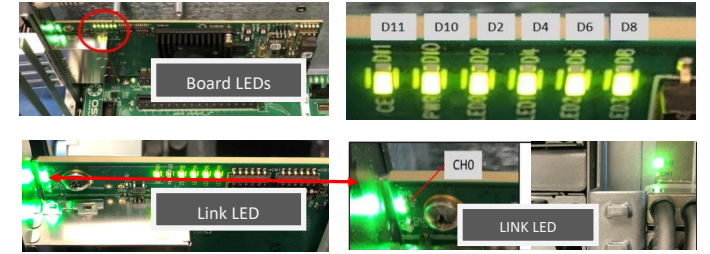

12

Unit is Ready

The unit is now ready to use.

- To install your PCIe cards, shutdown the expansion unit and computer completely.
- Disconnect power cables from the expansion unit.
- Plug in your PCIe cards in the downstream slots and secure it.
- Reconnect power cables to expansion unit.
- Turn ON the computer.

Please refer to the manual for more details.

13

ARF Cables & Backplane Dipswitch Settings

Make sure both backplanes are linked together using two ARF cables.



Set the dipswitches on each backplane accordingly. See below

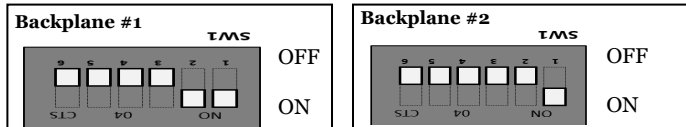

2

Need More Help?

Download the User Manual at www.onestopsystems.com
 One Stop Systems Support: www.onestopsystems.com/support-0
 Toll Free: +1 (877) 438-2724 Local: +1 (760) 745-9883
 2235 Enterprise Street #110, Escondido, CA 92029



Electrostatic Discharge (ESD) Warning

Electrostatic Discharge (ESD) is the enemy of semiconductor devices. You should always take precautions to eliminate any electrostatic charge from your body and clothing before touching any semiconductor device or card by using an electrostatic wrist strap and/or rubber mat.

FCC Statement

NOTE: This equipment has been tested and found to comply with the limits for a Class A digital device, pursuant to part 15 of the FCC Rules. These limits are designed to provide reasonable protection against harmful interference when the equipment is operated in a commercial environment. This equipment generates, uses, and can radiate radio frequency energy and, if not installed and used in accordance with the instruction manual, may cause harmful interference to radio communications. Operation of this equipment in a residential area is likely to cause harmful interference in which case the user will be required to correct the interference at his own expense. Changes or modifications not expressly approved by the party responsible for compliance could void the user's authority to operate the equipment.
 This device complies with Part 15 of the FCC Rules. Operation is subject to the following two conditions: (1) this device may not cause harmful interference, and (2) this device must accept any interference received including interference that may cause undesired operation.

Industry Canada

This Class A digital apparatus complies with Canadian ICES-003.
 Cet appareil numérique de la classe A est conforme à la norme NMB-003 du Canada

CE

The product(s) described in this manual complies with all applicable European Union (CE) directives. One Stop Systems will not retest or recertify systems or components that have been reconfigured by customers.



OSS
ONE STOP SYSTEMS