

7 (For 10-Way Kits Only)

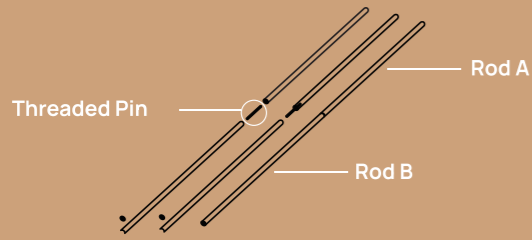

Vego Garden bracing rods are used to reinforce the strength of large raised beds. For C4080, C2580, C2595, C4065, and C2575 configurations, we recommend the use of bracing rods. For 2.5ft wide raised beds, use Rod A only; and for 4ft wide raised beds, use the threaded pin provided to connect Rod A and B.

8 For 4ft wide configurations, install two 4ft bracing rods in the two seams in the middle. For 2.5ft wide configurations, install two bracing rods on either side of the center seam.

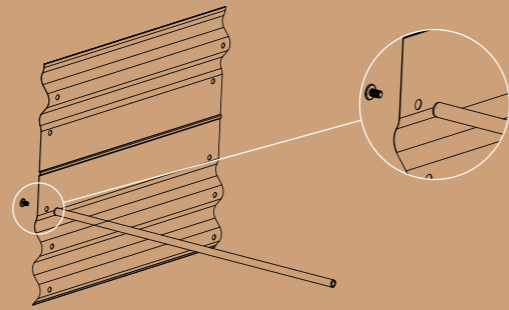

9 Install the bracing rod between two parallel bolt holes. Attach the bolt, panel and rod loosely, and ensure the rod is connected through the third bolt hole from the top. Finally, fasten it securely with a screwdriver. Now, your garden bed installation is complete! Happy gardening!

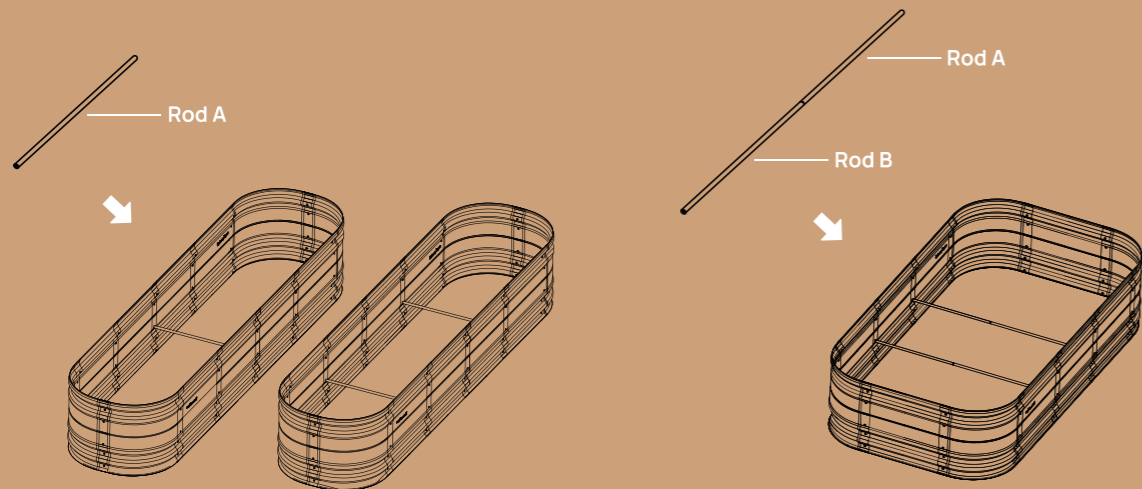

10 Use the Magnetic Plant Tag to make records of plant types in your garden and their planting times. (Note: Only use water-based markers on the tag, as oil-based markers cannot be erased).

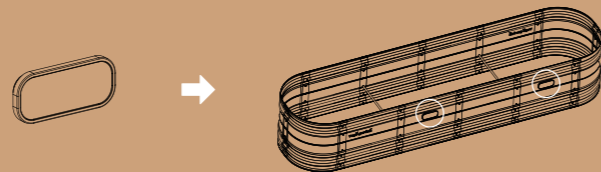

Contact Us

+1 (866) 597-1888

Vego Garden Academy

vegogarden.com

vego_garden

hello@vegogarden.com

Houston, TX



Assembly Videos

vegō garden®

General Manual for 17" Tall Novel Raised Garden Bed



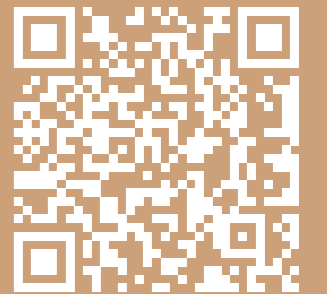









Copyright 2023 Vego Garden Inc.



Assembly Videos

Room to grow.

Parts List

Configuration	4-Way Kit	6-Way Kit	9-Way Kit	10-Way Kit
Parts List				
C10 Corner Panel 	X4	X4	X4	
C12 Corner Panel 				X4
S15 Side Panel 	X2	X4	X6	X4
S20 Side Panel 				X2
S15 Side Panel With Logo 	X2	X2	X2	
S20 Side Panel With Logo 				X2
B1 Bolt M6X10 	X40	X50	X60	X60
FCN Flange Cap Nut 	X16	X20	X24	X24
FSN Flange Standard Nut 	X24	X30	X36	X36
SE Safety Edging 	X1	X1	X1	X1
BR Bracing Rods 			X1	X4
LW L Wrench 	X1	X1	X1	X1
Magenetic Plant Tag 	X2	X2	X2	X2

Assembly Guide

www.vegogarden.com/assembly

1 Remove the protective film from all panels, and lay them on a flat surface according to the configuration you selected.

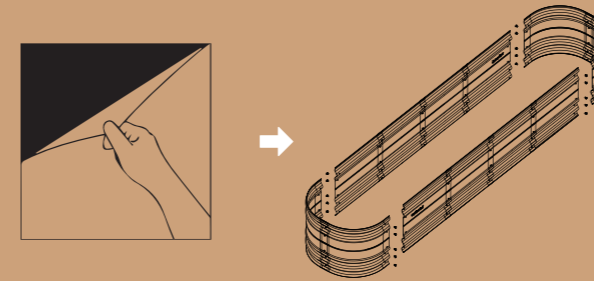

2 Cap nuts are used for the top two rows, and standard nuts are used for the lower four rows. Assemble all the straight panels. First, attach all the bolts and nuts loosely, then fasten securely using a wrench or with a screwdriver and cordless drill.

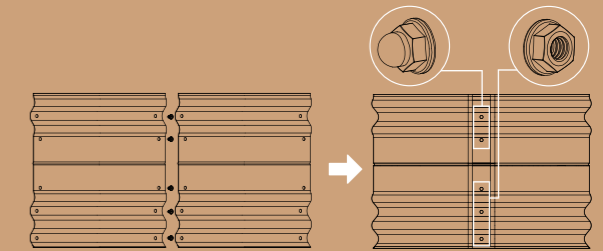

3 Make sure that each nut and bolt is tightly fastened to fully support the raised garden bed.

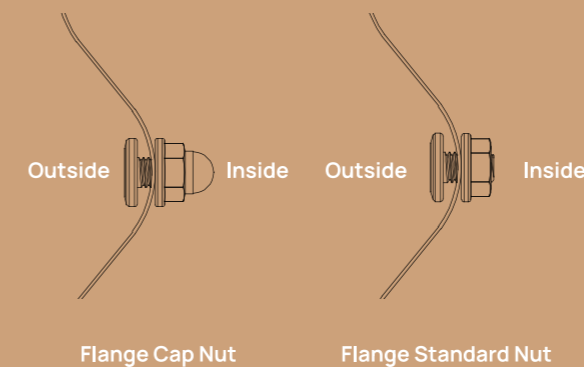

4 After the straight panels are assembled, attach corner panels to straight panels via the same method. Make sure the corner panels are attached on the outside of the straight panels.

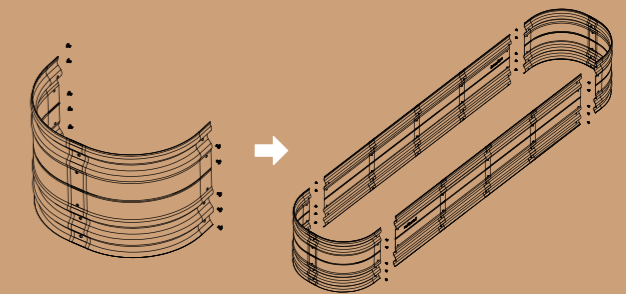

5 Push the safety edging along the top rolled steel edge, and remove any extra length.

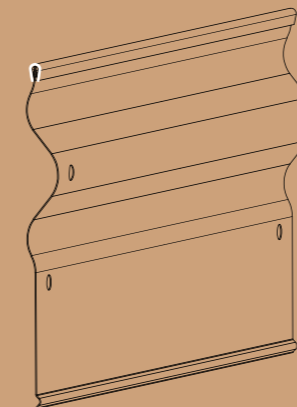

6 (For 9-Way Kits, C2080 Only)

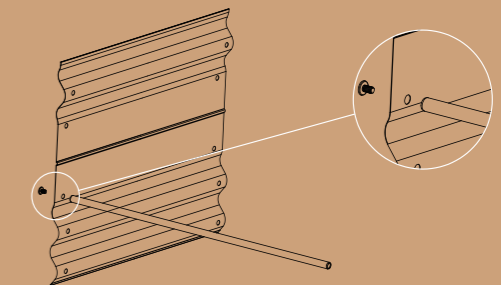

Bracing rods are used to reinforce the strength of long raised beds. Only the 2ft x 8ft configuration requires a 2ft wide bracing rod. Install the rod between two parallel bolt holes. Attach the bolt, panel and rod loosely, and ensure the rod is connected through the third bolt hole from the top. Finally, fasten it tightly with a screwdriver to reinforce your raised bed.