

Thank you for buying 'Round Caddy 3 Tray'
Assembly instructions.

Fixings (as marked):

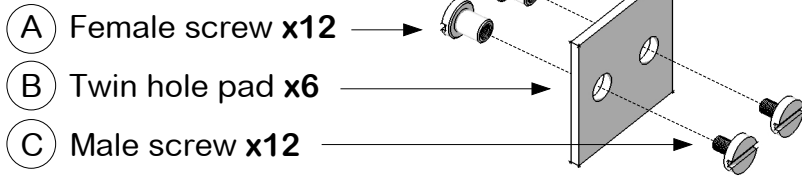

Parts (as marked):

- (1) Base tray with non slip feet - x1
- (2) Handle - x1
- (3) Tray - x2

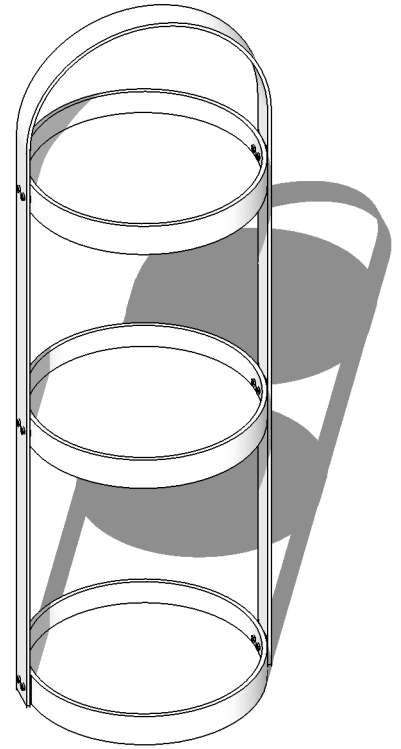

CARE INSTRUCTIONS:

- . Wipe clean using a soft damp cloth.
- . Do not use abrasive cleaners which may contain ammonia or solvents and could damage the surface finish.
- . Do not expose to excessive heat or humidity.
- . Do not leave in prolonged contact with water.

CAUTION:

- . Adult assembly required.
- . This item contains small parts that have sharp points and edges in the unassembled state.
- . Take care not to scratch surface finishes when unpacking and during assembly.
- . Maximum load per tray 1.5kg.

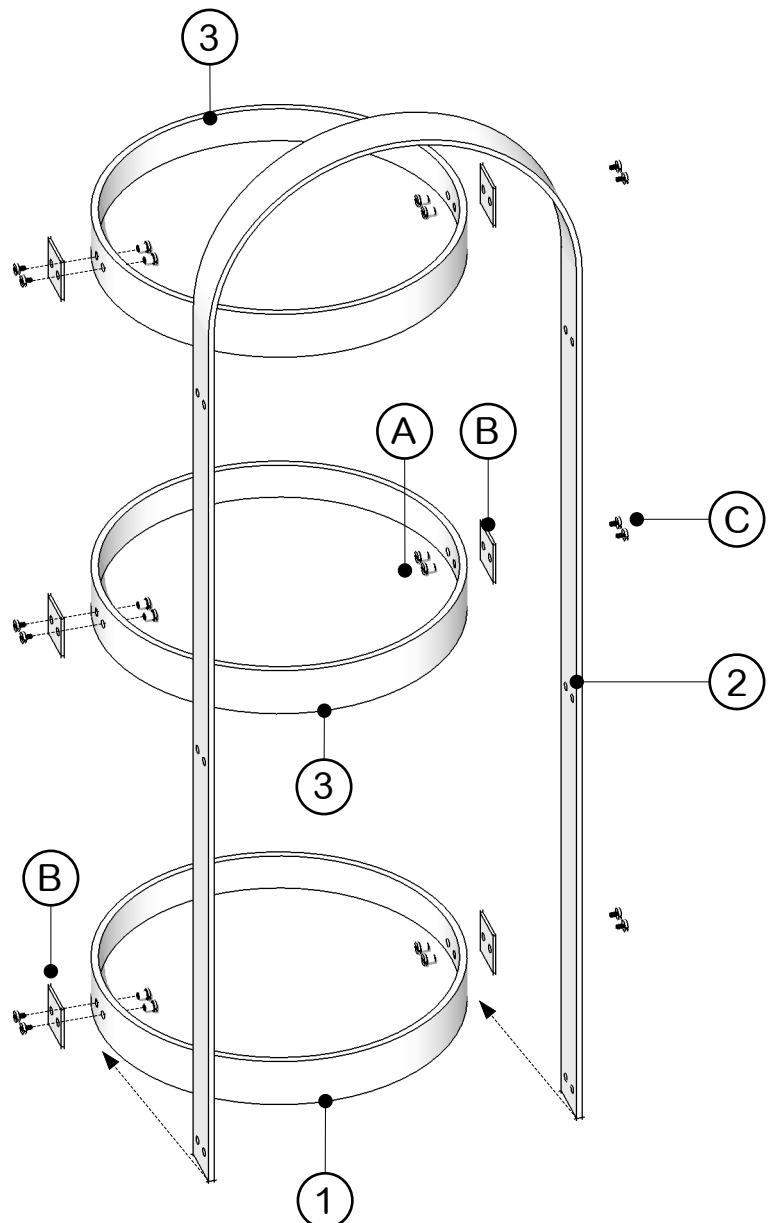

Stick the twin hole pad (B) to the inside face of the handle (2) so the holes are aligned. Loosely fix the tray with silicon feet (1) to bottom of the handle (2) **Before continuing double check you have picked the correct tray for the base.**

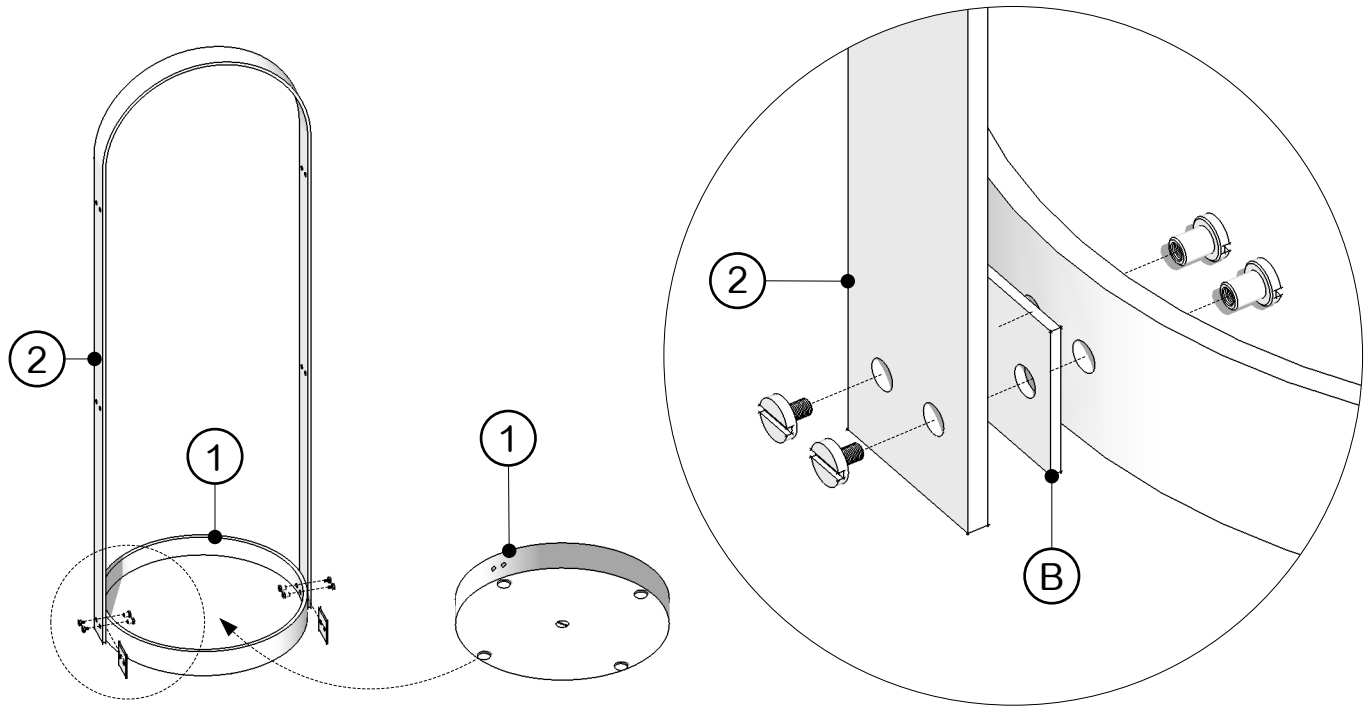

Fix the middle and upper tray to the handle using supplied screws (A) & (C) and pads (B) in the same way.

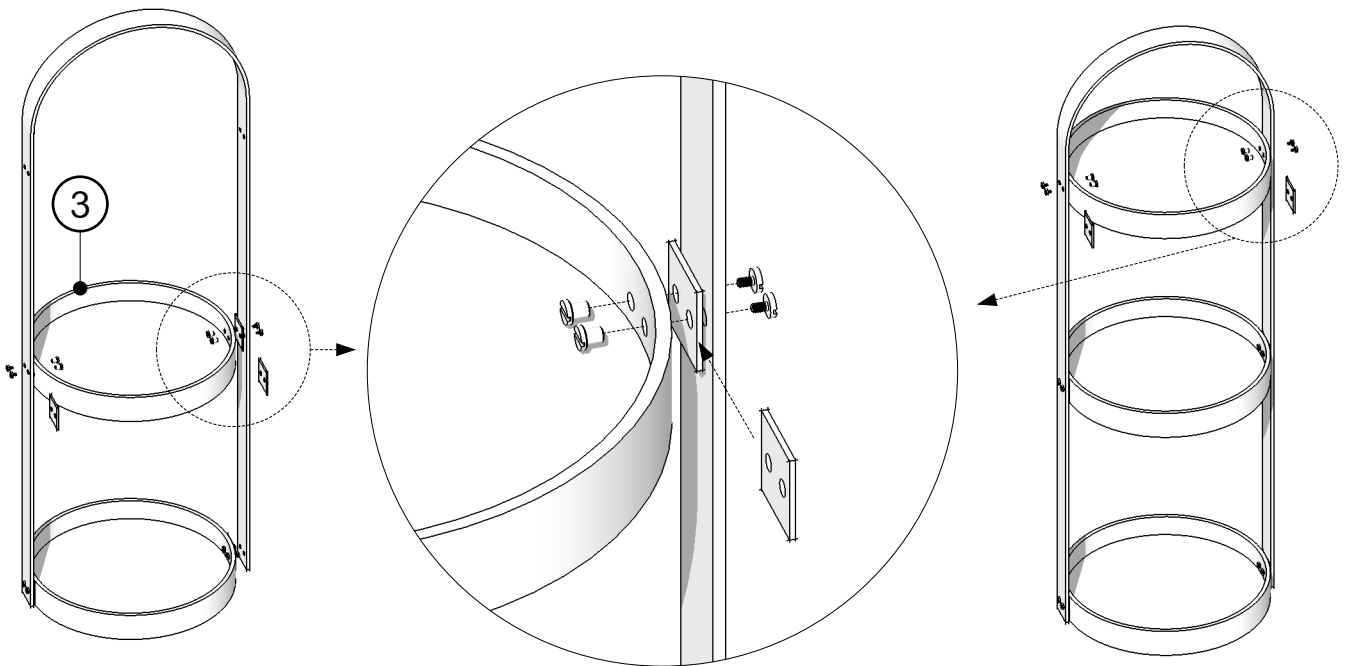

Adjust all the trays at right angles to the handle and tighten the screws.