

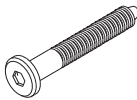



50015 - 50021 OAK TORSION DINING TABLE - SQUARE ASSEMBLY INSTRUCTION FOR TABLE INSTALLATION

HARDWARE ENCLOSED

| | | | | |
|------------------------------------------------------------------------------------------------------------------------|------------------------------------------------------------------------------------------------------------------------|---------------------------------------------------------------------------------------------------------------------------|---------------------------------------------------------------------------------------------------------------------------|---------------------------------------------------------------------------------------------------------------|
|  <p>JCBC SCREW M8x50 (3X)</p> |  <p>JCBC SCREW M8x16 (9X)</p> |  <p>METAL PLATE (SMALL) (1X)</p> |  <p>METAL PLATE (LARGE) (1X)</p> |  <p>RUBBER PAD (6X)</p> |
|------------------------------------------------------------------------------------------------------------------------|------------------------------------------------------------------------------------------------------------------------|---------------------------------------------------------------------------------------------------------------------------|---------------------------------------------------------------------------------------------------------------------------|---------------------------------------------------------------------------------------------------------------|

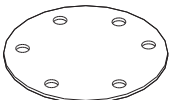
TOOL

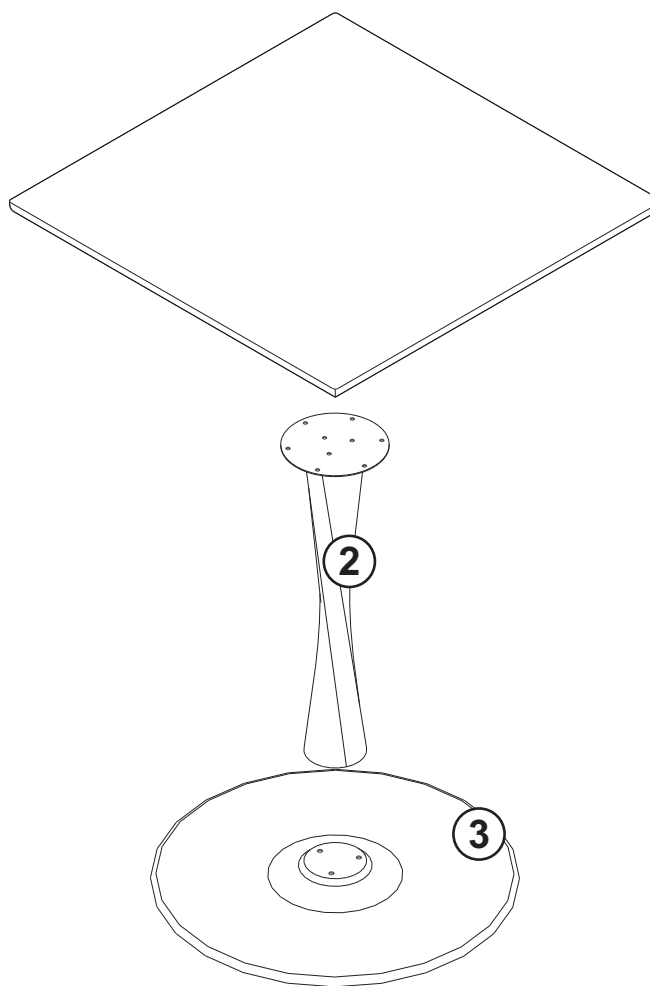
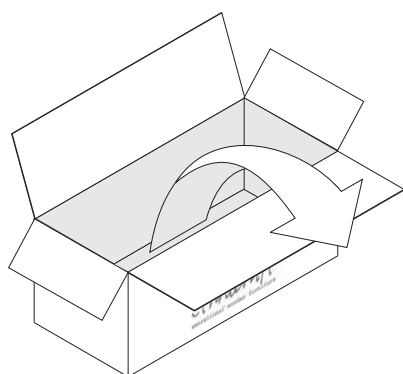
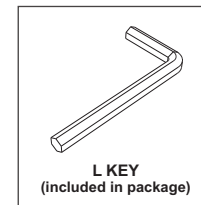

IN YOUR PACKAGE :

ASSEMBLY INSTRUCTION
HARDWARES (AS LISTED ABOVE)

PARTS TO BE INSTALLED

1. TABLE TOP 1 pc
2. CENTER LEG 1 pc
3. LEG BASE 1pc

SYMBOLS



DIRECTION

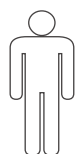

NUMBER OF
PERSONS NEEDED



USE L KEY
TO TIGHTEN

NOTICE

| | |
|--|-----------|
| | |
| | <p>X2</p> |

50015 - 50021 OAK TORSION DINING TABLE - SQUARE ASSEMBLY INSTRUCTION FOR TABLE INSTALLATION

A INSTALLING METAL PLATE TO THE CENTER LEG

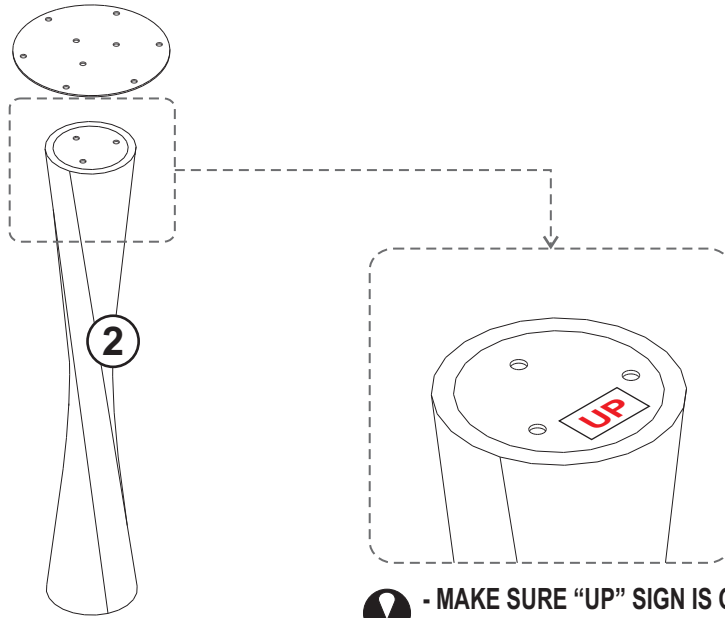

- ! - MAKE SURE "UP" SIGN IS ON TOP / ABOVE
- USE THE SCREW M8x16 (3X)

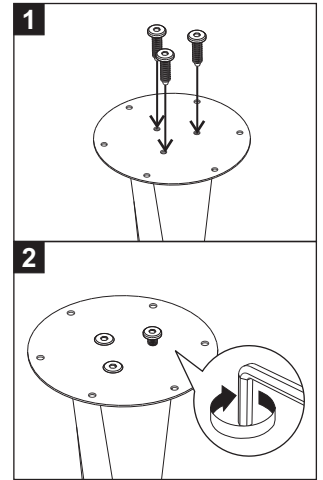

- ! TIGHTEN FULLY

B INSTALLING CENTER LEG TO TOP TABLE

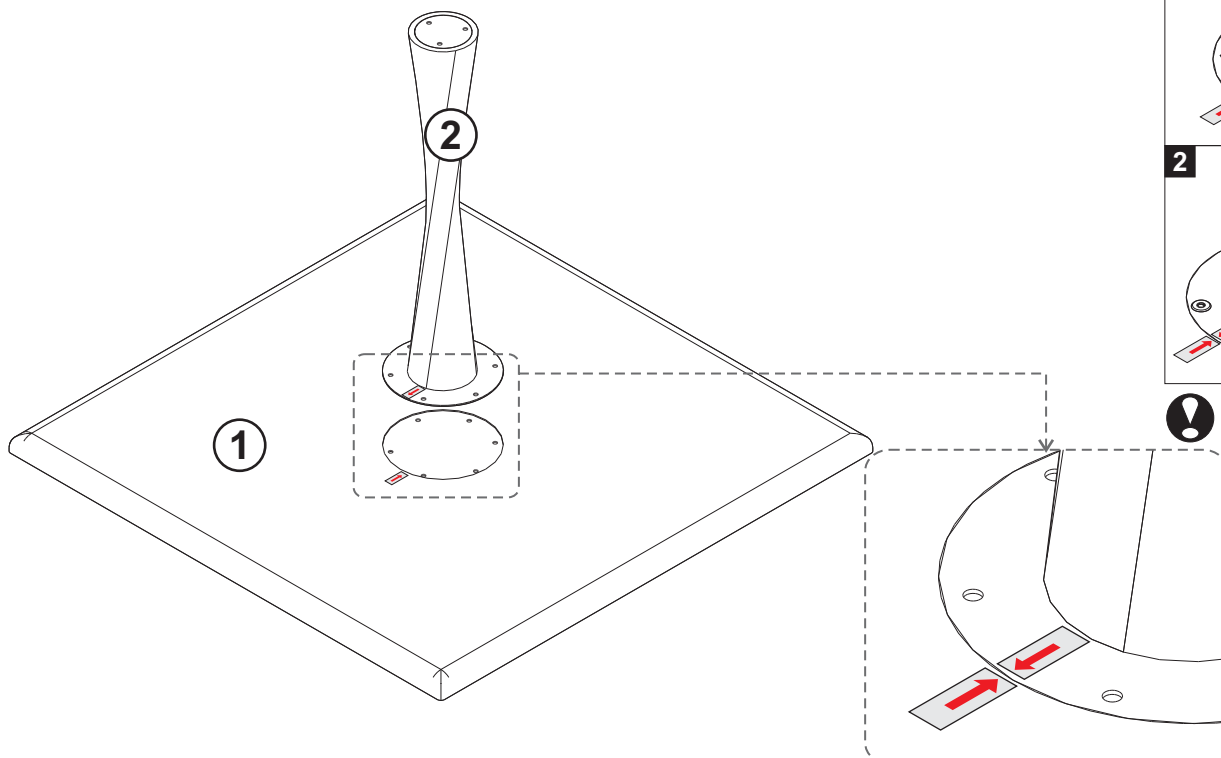

- ! - ALWAYS REFER THE STICKER
- USE THE SCREW M8x16 (6X)

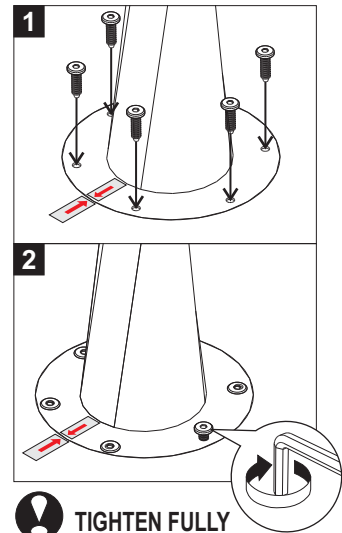

- ! TIGHTEN FULLY

50015 - 50021 OAK TORSION DINING TABLE - SQUARE ASSEMBLY INSTRUCTION FOR TABLE INSTALLATION

C INSTALLING LEG BASE

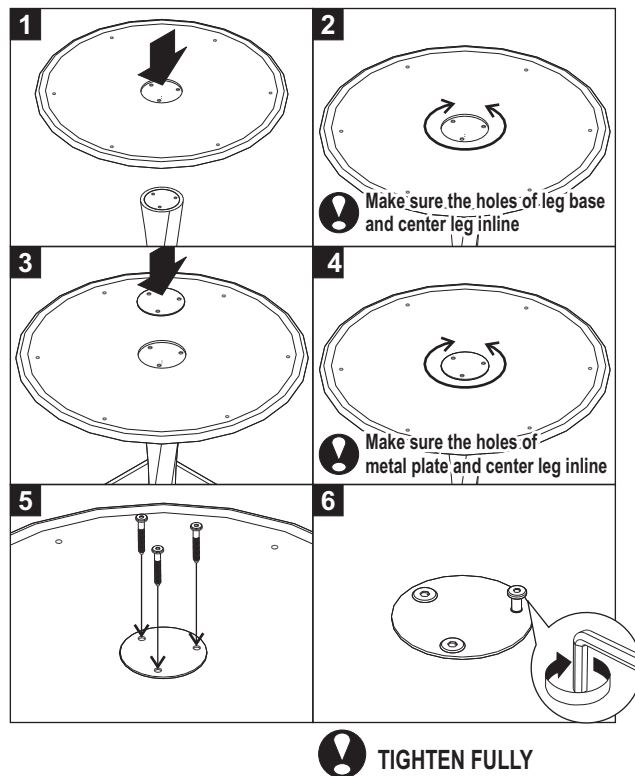
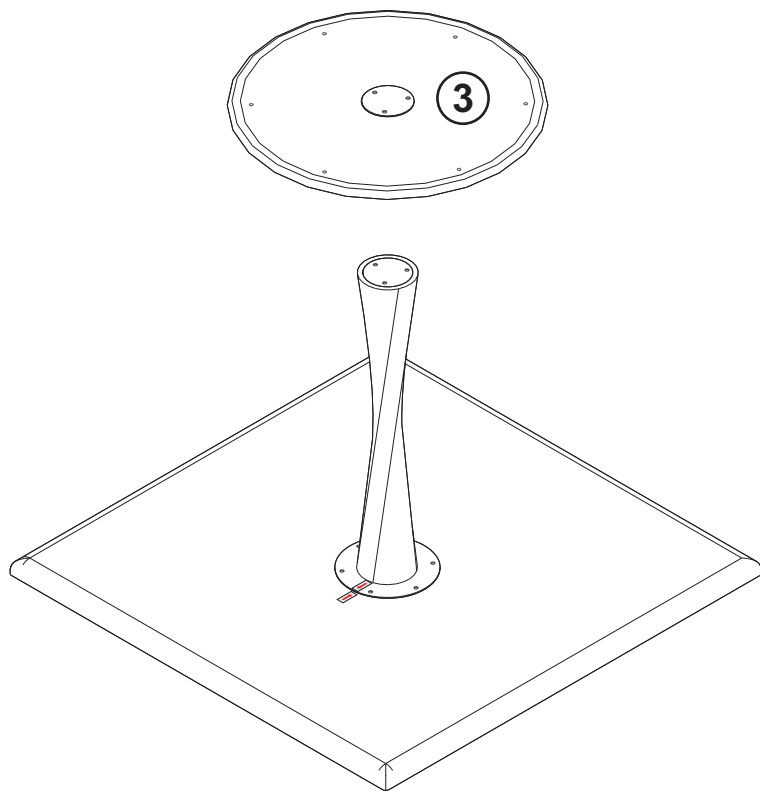

D ADJUST LEVELER

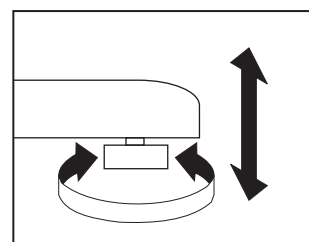
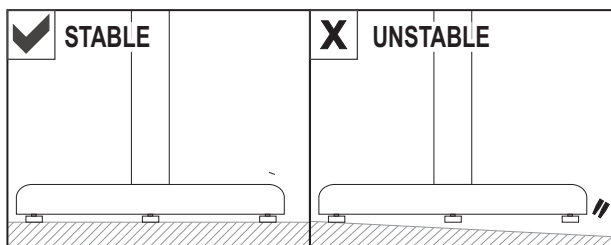
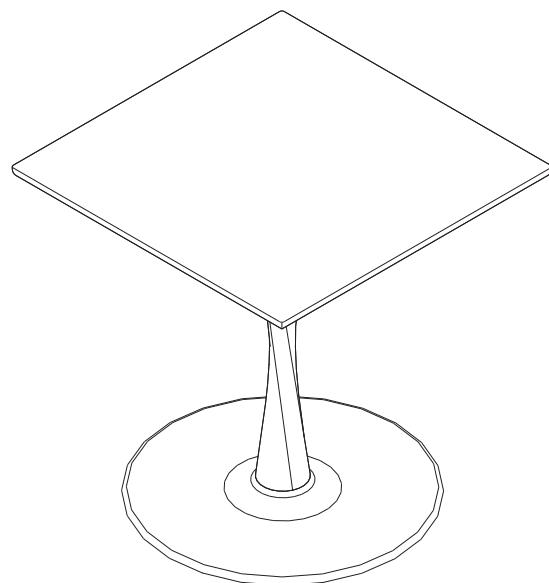
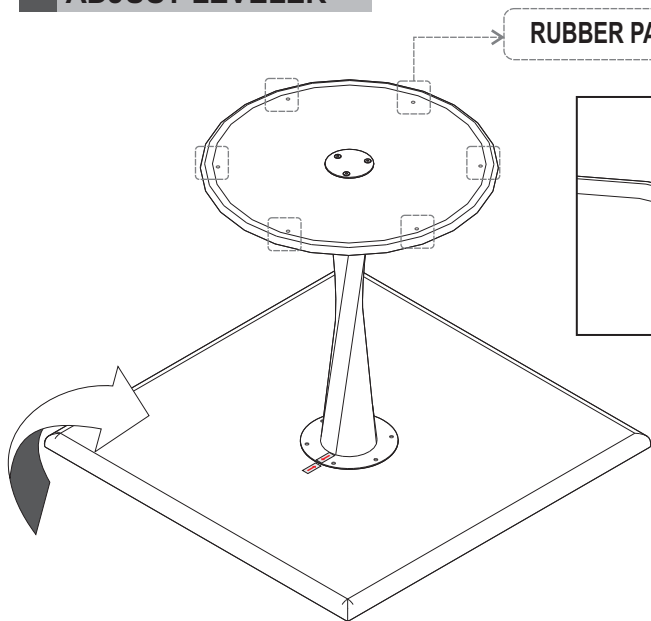

NOTE :
THIS IS A COMPULSORY ACTION TO MAKE SURE ALL OF THE RUBBER PADS TOUCH THE GROUND!