

www.pezzani.eu

pezzani[®]

AGGIORNAMENTO CATALOGO
CATALOGUE UPDATE

AGGIORNAMENTO CATALOGO
CATALOGUE UPDATE

pezzani[®]

Indice

Index

TAVOLI-CONSOLLE E SEDIE CHIUDIBILI <i>CONSOLE-TABLES AND FOLDING CHAIRS</i>	pag.	6-47
SPECCHIERE <i>MIRRORS</i>	pag.	48-65
LIBRERIE <i>BOOKCASES</i>	pag.	66-83
SCRIVANIE <i>DESKS</i>	pag.	84-85
TAVOLINI, TAVOLI BASSI E PORTARIVISTE <i>COFFEE TABLES AND MAGAZINE-RACKS</i>	pag.	86-99
CARRELLI CUCINA <i>KITCHEN CARTS</i>	pag.	100-101

Design: Pezzani

Hermés

Tavolo-Consolle trasformabile con apertura a libro del top in laminato ecologico spessore 18 mm. La struttura è composta da 2 **gambe girevoli** realizzate in acciaio tondo pieno Ø 12 mm verniciato con finitura sablé.

Table-Console with double leaf opening top made of eco-friendly laminate 18 mm thick. The structure is made of 2 turning legs made of steel rods Ø 12 mm colored with sandblasted finishing.



0/441

chiuso è un'elegante consolle
closed is an elegant console
140x40x77h



0/441

aperto è un pratico tavolo
open is a practical table
140x80x75h



Un sistema di
apertura semplice
e funzionale

*A simple and
very functional
opening system*



rotazione delle gambe di 110°
110° legs rotation

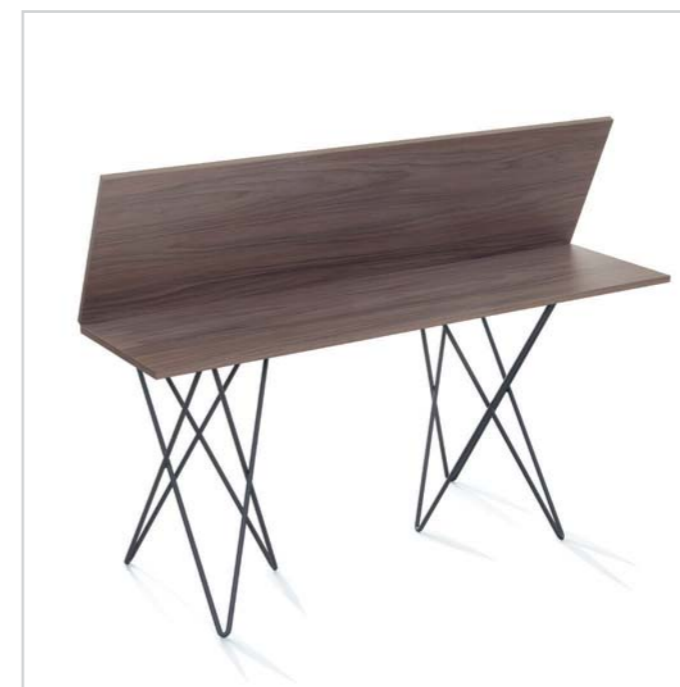

apertura a libro del top
double leaf opening top



0/441
chiuso è un'elegante consolle
closed is an elegant console
140x40x77h



0/441
aperto è un pratico tavolo
open is a practical table
140x80x75h

Design: Pezzani

Meg

La consolle Meg ha la struttura realizzata in acciaio tondo pieno Ø 12 mm verniciato con finitura sablé ed il top in laminato ecologico spessore 18 mm.

The structure of this console is made of steel rods Ø 12 mm colored with sandblasted finishing and the top is made of eco-friendly laminate 18 mm thick



0/440
consolle fissa
console
cm 90×40×75h



0/440
consolle fissa
console
cm 90×40×75h

Design: Pezzani

Excel

Tavolo-Consolle allungabile con struttura in lamina d'acciaio e gambe in acciaio tondo pieno da 12 mm verniciata con finitura sablé. Il top e le 5 allunghe in dotazione (da cm 45 cadauna) sono realizzati in laminato ecologico spessore 18 mm. Gambe pieghevoli di supporto in acciaio inox e guida estensibile in alluminio.

*Table-Console with extensions.
Structure made of sandblasted colored steel foil and legs of steel rods 12 mm.
Top and 5 extensions (45 cm each), are made of eco-friendly laminate 18 mm thick.
Stainless steel folding legs and aluminium extension slide.*



0/425
Tavolo/consolle (chiuso)
Table-console (closed)
cm 90×45×75h



0/426
Tavolo-consolle (chiuso)
Table-console (closed)
cm 120×45×75h



O/425 - larghezza (wide) cm 90

Apertura massima (max extension): cm 270(45+5×45)×90×75h
chiuso (closed): cm 45×90×75h

Una consolle
compatta ed
elegante che
diventa un
tavolo di grandi
dimensioni

*A compact and
elegant console
that turns into
a large table*



0/426- larghezza (wide) cm 120

Apertura massima (max extension): cm 270(45+5×45)×120×75h

chiuso (closed): cm 45×120×75h

Design: Pezzani

Leonardo^{new}



0/420 - larghezza (wide) cm 90

Apertura massima (max extension): cm 270(45+5x45)x90x75h
chiuso (closed): cm 45x90x75h



4 varianti di misura
per accontentare
ogni esigenza ...

E' largo 90 o 120 cm
ed in entrambe le versioni può
essere lungo 180 cm (3 allunghe)
o 270 cm (5 allunghe).
La guida estensibile è in alluminio.
Le gambe pieghevoli di sostegno
(presenti solo nella versione a 5
allunghe) sono in acciaio inox.

4 size variants
to meet every
need ...

It is 90 or 120 cm wide
and in both variants, it can
be long 180 cm (3 extensions)
or 270 cm (5 extensions).
The extension slide is made of
aluminium. The stainless steel
folding legs are supplied only for
the variant with 5 extensions



O/421
Tavolo-consolle (chiuso)
Table-console (closed)
cm 120x45x75h

largo 120 cm
cm 120 wide



O/421 5 allunghe (5 extensions)
apertura max: cm 270(45+5x45)x120x75h
max extension
chiuso: cm 120x45x75h
closed

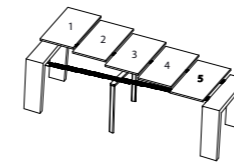

O/421.S 3 allunghe (3 extensions)
apertura max: cm 180(45+3x45)x120x75h
max extension
chiuso: cm 120x45x75h
closed

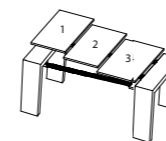

largo 90 cm
cm 90 wide



0/420 5 allunghe (5 extensions)
apertura max: cm 270(45+5×45)×90×75h
max extension
chiuso: cm 90×45×75h
closed



0/420.S 3 allunghe (3 extensions)
apertura max: cm 180(45+3×45)×90×75h
max extension
chiuso: cm 90×45×75h
closed



**8 finiture disponibili
per trovare il giusto
abbinamento ...**

Top e struttura sono realizzati
in laminato ecologico spessore
18 e 25 mm.

*8 available colors
to find the right
match ...*

*Top and structure are made of
Eco-friendly laminate 18 and
25 mm thick.*



bianco matrix
matrix white



grigio tortora
dove-grey

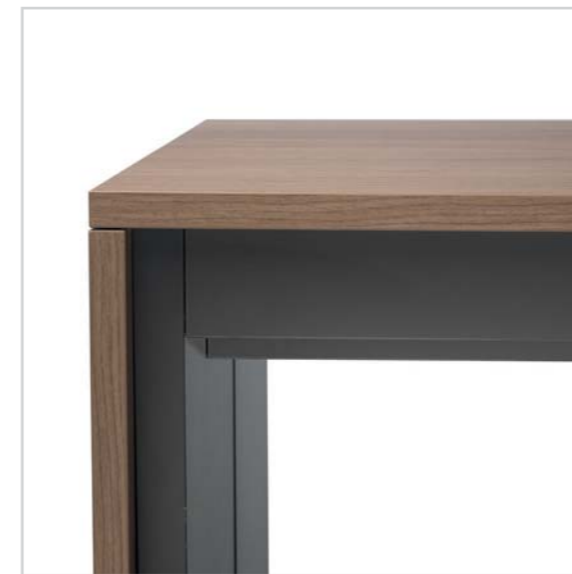

noce
walnut



noce ardesia
ardesia walnut



bianco opaco
mat white



grigio ardesia
ardesia grey



cemento
cement



nero carbone
carbon black

ed una versione speciale
con struttura e top in laminato
rivestiti in lamina di alluminio
con finitura acciaio satinato

*and a special variant
with laminate structure and top
covered with aluminium foil
with brushed steel finishing*



acciaio satinato
brushed steel

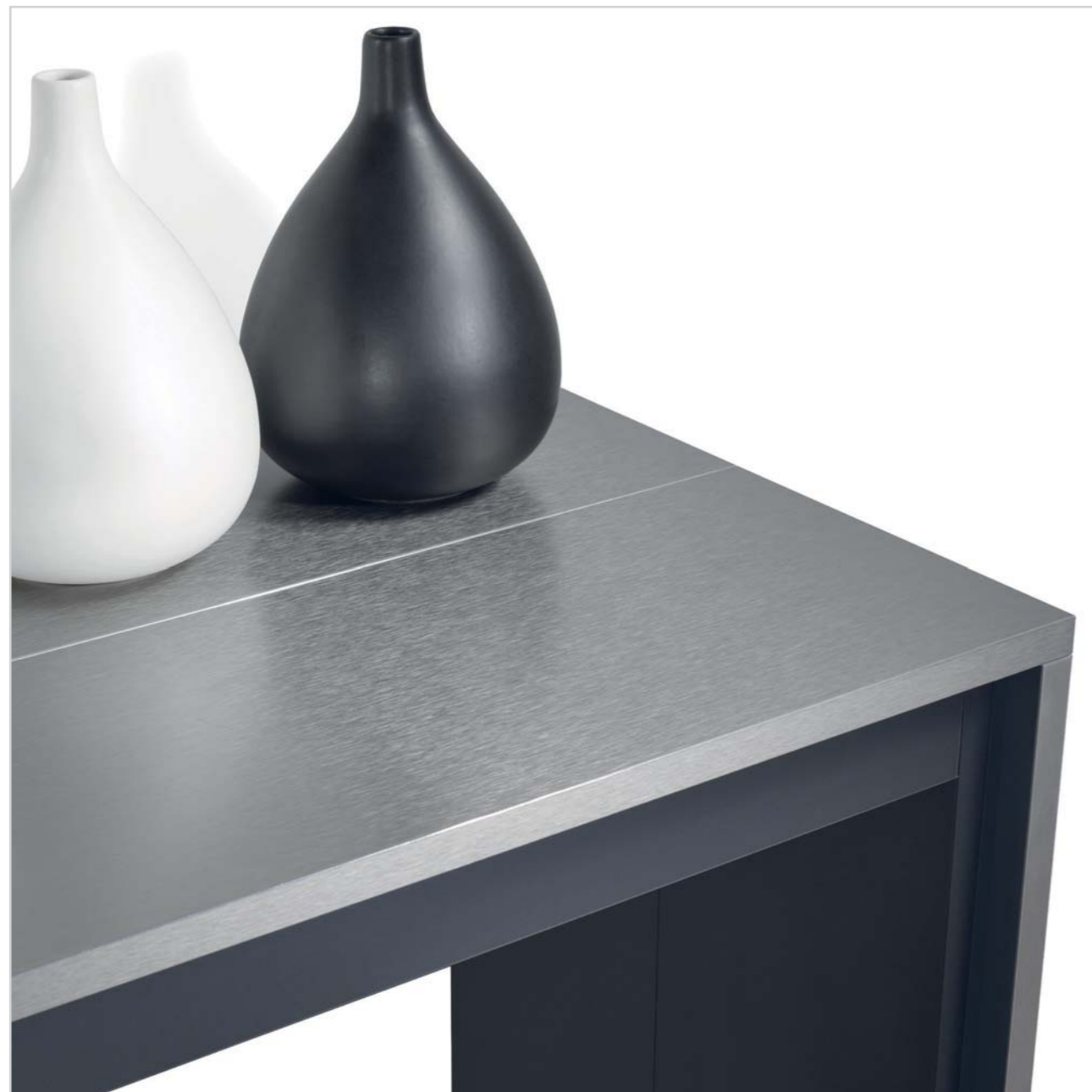

O/421 - larghezza (wide) cm 120

Apertura massima (max extension): cm 270(45+5x45)x120x75h
chiuso (closed): cm 45x120x75h

Design: Pezzani

Ulisse



0/416 - larghezza (wide) cm 120
Apertura massima (max extension): cm 285(45+4×60)×120×75h
chiuso (closed): cm 45×120×75h

contiene le
4 allunghe
it contains its
4 extensions



Tavolo-Consolle allungabile con struttura in lamina d'acciaio verniciata sablé. Top in laminato ecologico spessore 18 mm. Il tavolo viene fornito completo di 4 allunghe (cm 60 cadauna) che trovano alloggiamento all'interno della struttura e diventano il fondo della consolle integrandosi perfettamente nella struttura. La guida estensibile è in alluminio. Le gambe pieghevoli di sostegno sono in acciaio inox.

O/415 - larghezza (wide) cm 90

Apertura massima (max extension): cm 285(45+4x60)x90x75h
chiuso (closed): cm 45x90x75h

*Table-console with extensions.
Structure made of sandblasted colored steel foil. Top made of Eco-friendly laminate 18 mm thick. This table-console is supplied with 4 extensions (60 cm each) which take place into the structure and become the back of the console. The extension slide is made of aluminium and supporting folding legs are made of stainless steel.*





Il tavolo viene fornito completo di 4 allunghe (cm 60 cadauna) che trovano alloggio all'interno della struttura e diventano il fondo della consolle integrandosi perfettamente nella struttura.

This table-console is supplied with 4 extensions (60 cm each) which take place into the structure and become the back of the console.



Design: Pezzani

Archimede^{new}

Il tavolo chiudibile con chiusure
che contiene e nasconde
4/6 sedie pieghevoli
First, Zeta o Piper

*The folding table with doors
that contains and hides
4/6 folding chairs
First, Zeta or Piper*



chiuso cm 34x90x73h
closed



aperto cm 170x90x73h
open

0/402.C

Tavolo chiudibile porta-sedie
con struttura e chiusure laterali
(una con sportello) realizzate
in acciaio verniciato, top in
laminato ecologico da 18 mm

*Folding table containing folding
chairs. Structure and lateral
closing (one with door) made of
sandblasted colored steel, top
made of*



Design: Pezzani

Archimede^{new}

Abbiamo creato una nuova consolle (chiusa sul retro) per accogliere e nascondere il tavolo chiudibile Archimede (che contiene fino a 6 sedie First, Zeta o Piper).

This new console (closed on the back) hides and contains folding table ARCHIMEDE (holding 6 folding chairs First, Zeta or Piper).



0/405
Consolle realizzata in laminato ecologico bicolore 12 mm (esterno) + 18 mm (interno)
Console made of Eco-friendly two-tone laminate 12 mm thick (outside) + 18 mm thick (inside)
cm 96×36×77h

tavolo aperto cm 170×90×73h
open table



0/405.COMP-1
consolle ARCHIMEDE,
tavolo chiudibile,
6 sedie chiudibili ZETA
ARCHIMEDE console,
folding table, 6 folding chairs ZETA

Design: Pezzani

Plana

Tavolo/scrivania chiudibile da parete, con ripiano in alluminio da 4 mm (leggero, sottile e resistente) verniciato con le nostre finiture sablé combinato ad una pratica struttura di sostegno chiudibile in acciaio verniciato.

Wall folding table/desk top made of aluminium 4 mm thick (light, thin and strong) sandblasted colored combined with practical folding brackets made of colored steel.

chiuso misura solo 2,5 cm di profondità
closed is just 2,5 cm deep



0/85
tavolo/scrivania chiudibile
folding table/desk
cm 90x50





Si sblocca schiacciando i 2 pulsanti sulle staffe di sostegno in acciaio
To unlock it you only have to push the buttons on the steel folding brackets



Il ripiano in alluminio di soli 4 mm di spessore è rigido e leggero da movimentare
The 4 mm thick aluminium top is rigid and light to open and close



Le staffe di sostegno sopportano il carico senza flessioni
The folding brackets support the weight without bending



Chiuso misura solo 2,5 cm di profondità
Closed is just 2,5 cm deep

Design: Scutellà

Piper

Sedia pieghevole
struttura in acciaio verniciato
opaco, seduta e schienale in
polipropilene (PP).

*Folding chair
structure made of mat colored
steel, polypropylene (PP)
seat and back.*

SE04

cm 46x46x79h

○ Bianco
White

● Tortora
Dove grey

● Ardesia
Ardesia grey



44



45



SE04
cm 46x46x79h



solo 7,5 cm
di spessore
*just 7,5 cm
thick*



Chiusa è
estremamente
compatta e
ne possiamo
inserire tante
in poco spazio,
come nelle
nostre consolle
trasformabili

*When closed
it is very thin
and you can
put several of
them in a little
space, like in
our console-
tables*

Design: Pezzani

Elodie

Serie di specchi realizzati interamente con vetri dai sofisticati colori grigio fumé e bronzo.

Il vetro trasparente di colore grigio fumé (o bronzo) fa da cornice al vetro a specchio nello stesso tono. Cornice e specchio combinati hanno uno spessore di 10 mm (5 mm di vetro trasparente + 5 mm di vetro a specchio) e sono uniti da una pellicola adesiva di sicurezza.

Mirrors series made of glass with sophisticated colors: smoked grey and bronze.

Transparent smoked grey (or bronze) glass frames the mirror glass of the same shade.

Frame plus mirror are 10 mm thick (transparent glass 5 mm + mirror glass 5 mm) and are joint together by a special safety adhesive film.



0/535
specchio da parete
mirror
cm 85x85h



La struttura di alluminio sul retro garantisce un facile montaggio a parete su entrambi i lati e distanzia il vetro trasparente dalla parete di 2 cm permettendo alla luce di entrare creando affascinanti giochi di ombre in trasparenza.

You can easily fix it to the wall on both sides thanks to the aluminium structure on the back. Light that enters into the space of 2 cm between wall and transparent glass, creates fascinating shadow plays



0/536
specchio da terra
floor mirror
cm 78x196h



Design: Pezzani

Hide

La specchiera da terra HIDE misura solo 40 cm in larghezza e trova facile collocazione in spazi ridotti. Lo specchio è fissato ad un pannello di laminato ecologico da 12 mm che arriva a terra ed incorpora il sistema di fissaggio a parete.

Il vetro trasparente grigio fumé (o bronzo) fa da cornice allo specchio grigio fumé (o bronzo) che viene incollato al centro con una pellicola adesiva di sicurezza.

Transparent smoked grey (or bronze) glass that frames the smoked grey (or bronze) mirror joint together with a special safety adhesive film.

HIDE is a floor mirror 40 cm wide and it perfectly suits narrow spaces. The mirror is fixed on an eco-friendly laminate panel 12 mm thick that reaches the floor and includes the system to fix it to the wall.

0/547
specchio da terra
floor mirror
cm 40x198h

La specchiera HIDE è predisposta per essere applicata sul modulo libreria/portaoggetti (0/544)

HIDE mirror can be added to the bookcase/storage unit (0/544)



lato della libreria parzialmente nascosto dallo specchio
bookcase side partially hidden by the mirror



lato esterno della libreria con specchio
front side of the bookcase with mirror

0/544 + 0/547
libreria/portaoggetti + specchio
bookcase/holder unit + mirror
cm 40x36x198h

La specchiera reversibile HIDE
 è fissata sul modulo libreria
 0/544
 in posizione decentrata .
 Sporge a destra o a sinistra
 per nascondere parzialmente
 alla vista un lato della libreria/
 portaoggetti e quanto in essa
 contenuto

*HIDE reversible mirror is not
 fixed in the middle of bookcase
 unit, item 0/544.*

*It sticks out of the bookcase
 on the right or on the left to
 partially hide one side of the
 bookcase/storage unit and
 what it contains*

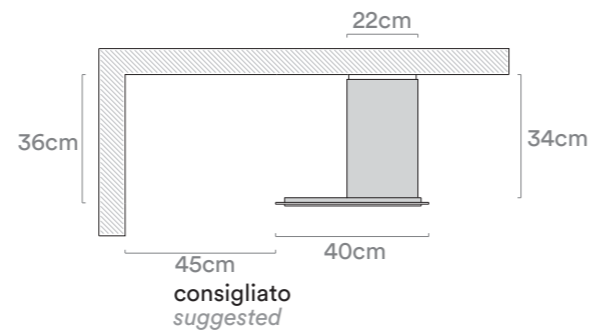

lato della
 libreria
 parzialmente
 nascosto dallo
 specchio
*bookcase
 side partially
 hidden by the
 mirror*



0/544 + 0/547
 libreria/portaoggetti + specchio
bookcase/holder + mirror
 cm 40x36x198h



La combinazione della libreria/
 portaoggetti e della specchiera
 HIDE crea una nicchia dove poter
 inserire anche portabiti da parete
*Bookcase/storage unit together
 with HIDE mirror, create a space
 where you can also hang
 coat-racks*

Design: Pezzani

Slide

SLIDE è un'elegante specchiera che scorre su binari agganciati al modulo libreria/portaoggetti. Soluzione elegante per trasformare piccoli spazi ad angolo in preziosi **guardaroba** dove riporre scarpe, abiti e molto altro.

***SLIDE** is an elegant mirror that slides on the tracks fixed to the bookcase/holder unit. This is a smart solution to convert small corners in precious **wardrobes** where you can put shoes, clothes and much more.*

Vetro a specchio grigio fumé (o bronzo) spessore 5 mm con fascia esterna acidata che ne disegna la cornice, accoppiato ad un pannello in laminato da 12 mm.
Smoked grey (or bronze) mirror glass 5 mm thick with external frosted band that outlines its frame, fixed to a laminate panel 12 mm thick.



**Specchio
guardaroba**
**Wardrobe
mirror**

0/544 + 0/548

libreria/portaoggetti + specchio scorrevole
bookcase/holder unit + sliding mirror
cm 70x38x194h

aperto
open

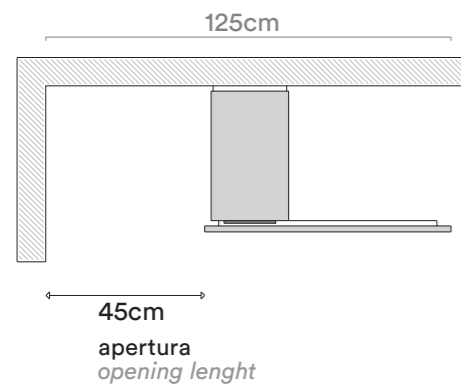

chiuso
closed

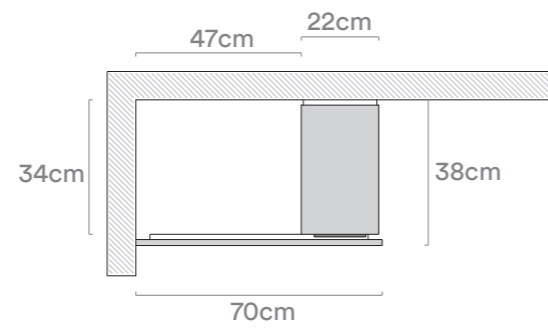

lato nascosto
della libreria
visibile solo
quando lo
specchio è
aperto
*hidden side of
the bookcase
visible only
when mirror
is open*



La specchiera SLIDE chiusa nasconde alla vista gli oggetti riposti sui 5 ripiani interni della libreria e tutto quanto può essere contenuto nel vano dietro lo specchio.

SLIDE mirror (closed) hides objects in its 5 inner bookcase shelves and anything else you can store in its useful space.

Dettaglio del pannello in dotazione nel modulo libreria per compensare il battiscopa.
Detail of the laminate panel included into the bookcase unit to compensate the baseboard thickness



Lo specchio è montato su un pannello di laminato da 12 mm dotato di ruote e guide di scorrimento.
The mirror is fixed to a laminate panel 12 mm thick with castors and sliding tracks



0/544 + 0/548
 libreria/portaoggetti + specchio scorrevole
bookcase/holder unit + sliding mirror
 cm 70x38x194h

Libreria/portaoggetti reversibile 0/544 realizzata in acciaio verniciato sablé, diventa struttura di sostegno per le specchiere HIDE e SLIDE oppure colonna di chiusura per la specchiera a battente RETTANGOLO.

Reversible bookcase/holder item 0/544 made of colored sandblasted steel. It is a supporting structure for HIDE and SLIDE mirrors or closing column for our mirrors with swing closing RETTANGOLO.



Lato Libreria a 4 ripiani
Bookcase side with 4 shelves

Retro con 5 ripiani portascarpe ed oggetti
Back side with 5 shelves for objects/shoes

Design: Pezzani

Rettangolo

La libreria/portaoggetti 0/544 diventa la nuova colonna di chiusura per la specchiera a battente RETTANGOLO.

The bookcase/holder item 0/544 is also the new closing column for our mirrors RETTANGOLO with swing closing.

apertura a destra
right opening

0/544
libreria reversibile
reversible bookcase

0/543.DX
kit montante destro
right jamb set



Specchio
a scelta
Selected
mirror

apertura a sinistra
left opening

0/543.SX
kit montante sinistro
left jamb set

0/544
libreria reversibile
reversible bookcase



Specchio
a scelta
Selected
mirror



0/543.COMP-4
Specchio RIFLESSO, libreria e
kit montante destro RETTANGOLO,
accessori interni
RIFLESSO mirror, RETTANGOLO bookcase &
right jamb set, inside components
cm 38x95x192h

Design: Pezzani

Musa

La libreria componibile
ideale per chi ama
il design e lo stile
minimalista

*The modular bookcase
made for lovers of
modern design and
minimal style*



0/71.COMP-21
libreria/ bookcase
cm 155x38x200h

La struttura di MUSA è interamente realizzata in acciaio tondo pieno Ø 12 mm verniciato con finitura sablé.

Nella versione sottoriportata i ripiani in laminato ecologico da 12 mm, poggiano sulla struttura e dei fermi sono stati aggiunti nella parte sottostante per tenerli in posizione.

MUSA structure is made of steel rods Ø 12 mm colored with sandblasted finishing.

In this variant, shelves made of eco-friendly laminate 12 mm thick, are placed on the structure. Rubber stops placed under the shelves keep them in the right position.



dettaglio dei ripiani in laminato 12 mm e della schiena in acciaio accoppiato a specchio grigio fumé
details of laminate shelves 12 mm thick and steel back combined with grey smoked mirror



0/71.COMP-31
libreria
bookcase
cm 201x38x200h

In questa versione interamente realizzata in acciaio verniciato con finitura sablé, i **ripiani in metallo** si agganciano saldamente alla struttura.

*In this variant, all made of sandblasted colored steel, **steel shelves** are hooked to the structure.*

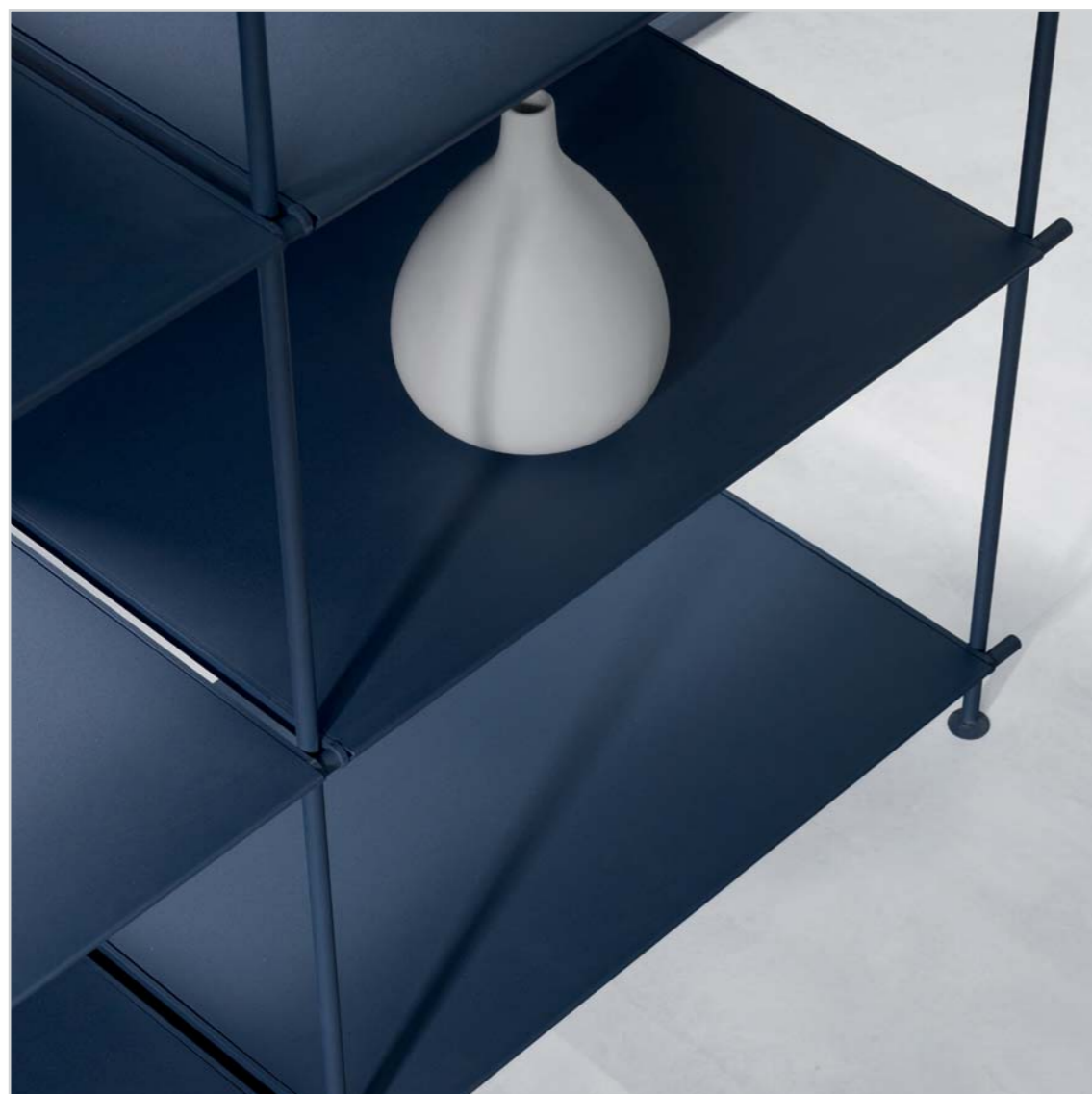

dettaglio dei ripiani in acciaio e del piedino in acciaio registrabile in altezza
details of the steel shelves and high-adjustable feet



0/71.COMP-21
libreria
bookcase
cm 155x38x200h

Versione con sofisticati ripiani in vetro acidato 8 mm temperato, retro verniciati tinta unita nei colori nero o bianco. Quello inferiore può essere fornito retro decorato con stampa digitale marmo nero del Sahara o bianco Fiorentino.

I ripiani in vetro poggiano sulla struttura e dei fermi sono stati aggiunti nella parte sottostante per tenerli in posizione.

Variant with shelves made of frosted toughened glass 8 mm thick, with solid black or white painted glass back. The lower one can be black Sahara or white Florentine marble decorated. This decoration is obtained by the digital printing of glass back.

These glass shelves are placed on the structure. Rubber stops placed under the shelves keep them in the right position.

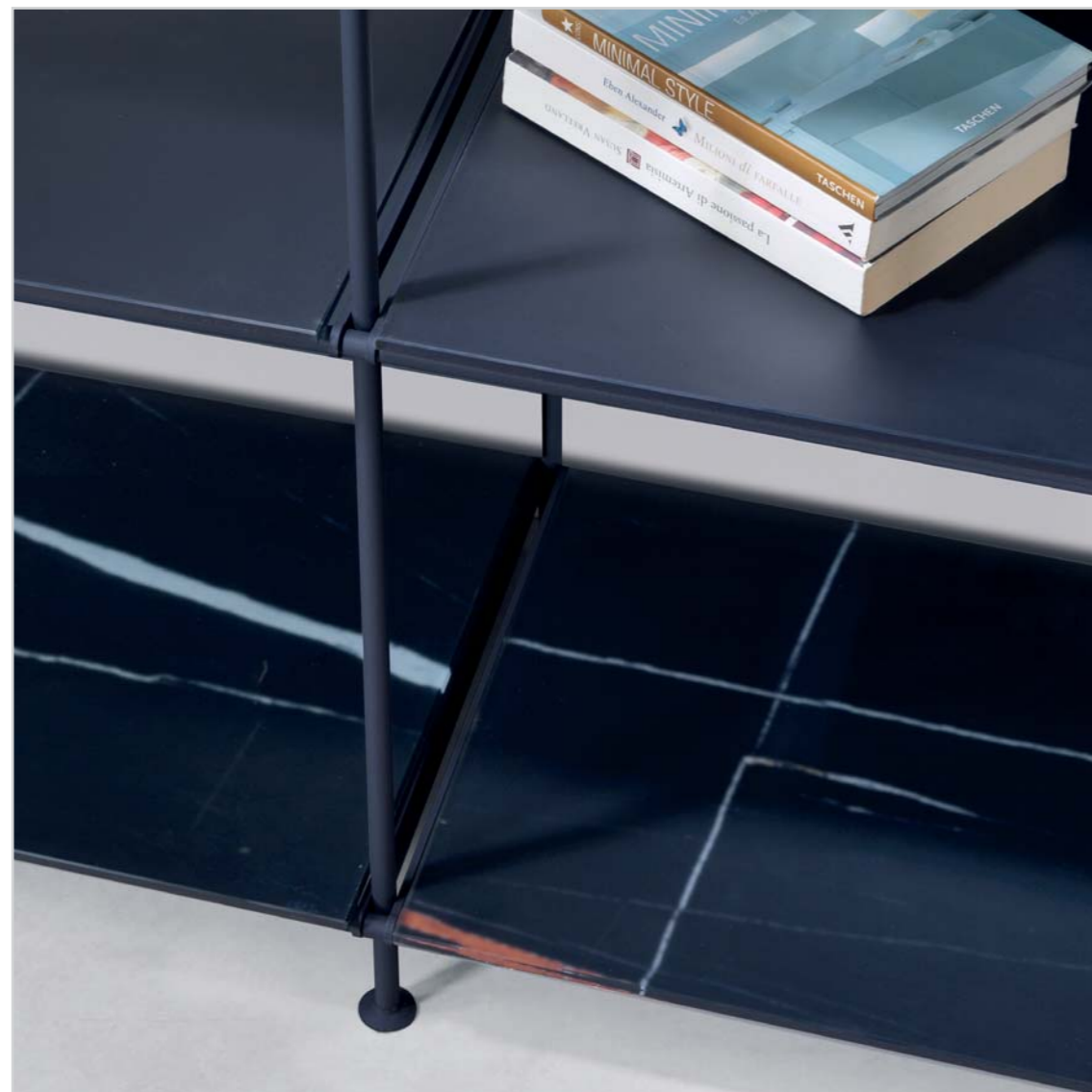

dettaglio ripiani in vetro acidato 8 mm tinta unita nero e decorati marmo Nero del Sahara
detail of frosted glass 8 mm thick solid black painted and black Sahara marble decorated



3 diverse altezze combinabili tra di loro

3 different heights that can be combined together

0/71.COMP-33
libreria
bookcase
cm 201x38x200h



0/71.COMP-22
libreria
bookcase
cm 140x38x200h



0/71.COMP-32
libreria
bookcase
cm 256x38x200h



O/71B-45
cm 45x38x86h



O/71B-60
cm 60x38x86h



O/71B-90
cm 90x38x86h



O/71M-45
cm 45x38x124h



O/71M-60
cm 60x38x124h



O/71M-90
cm 90x38x124h



O/71A-45
cm 45x38x200h



O/71A-60
cm 60x38x200h



O/71A-90
cm 90x38x200h

**Scegli la tua
configurazione
tra le numerose
opzioni disponibili**

*Choose your
configuration
among all
the available
options*

*schiena in acciaio
accoppiata a vetro
specchio grigio fumé
(optional)
steel back combined
with smoked mirror
glass (optional)*

*ripiani in acciaio
verniciato sablé
(agganciati alla
struttura)
steel shelves
sandblasted colored
(hooked to the
structure)*

*ripiani in vetro acidato
temperato da 8 mm
decorato marmo
con stampa digitale
(optional)
frosted glass shelves 8
mm thick with digital
printed back marble
decorated (optional)*

*schiena in acciaio
verniciato sablé
steel backs
sandblasted colored*

*ripiani in laminato
da 12 mm (appoggiati
sulla struttura)
laminated shelves 12
mm thick (placed on
the structure)*

*ripiani in vetro acidato
temperato da 8 mm
tinta unita (appoggiati
sulla struttura)
frosted glass shelves
8 mm thick with solid
color painted back
(placed on the structure)*



**Create liberamente
la vostra composizione**

*Create your
own bookcase*

Il sistema permette di creare le composizioni più adatte alle vostre esigenze **combinando tra loro i componenti di seguito riportati**

*The system allows you to realize the composition you need by **mixing the following components***

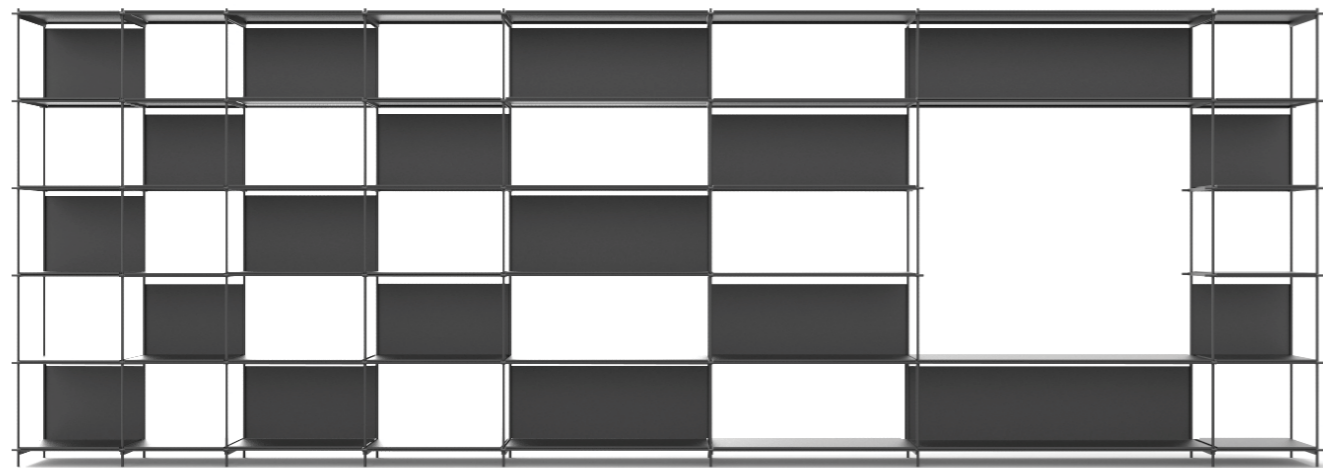
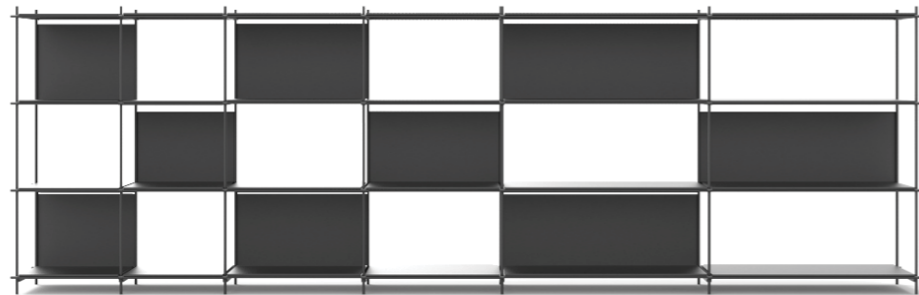
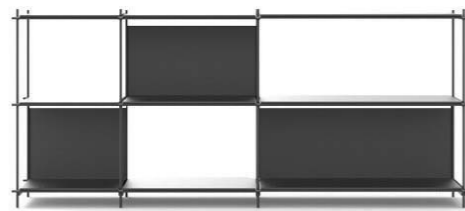

Fianchi portanti in acciaio tondo pieno verniciato sablé
Sides made of steel rods with sandblasted finishing

Set ripiani AUTOPORTANTI in acciaio, laminato o vetro
(la quantità di schiene inserite rende la struttura autoportante)
FREESTANDING set of shelves made of steel, laminate or glass (the quantity of backs of these sets make structure freestanding)

set ripiani da FISSARE A PARETE in acciaio, laminato o vetro
(si possono alternare a SET AUTOPORTANTI nelle composizioni autoportanti)
Set of shelves TO BE FIXED TO THE WALL made of steel, laminate or glass (it is possible to alternate this set with FREESTANDING ones in freestanding compositions)

fianco esterno
external side

fianco interno di collegamento
joint side

cm 43
set 3 ripiani
3 shelves set

cm 58
set 3 ripiani
3 shelves set

cm 88
set 3 ripiani
3 shelves set

0/71B-FE

0/71B-FI

0/71B-R43

0/71B-R58

0/71B-R88

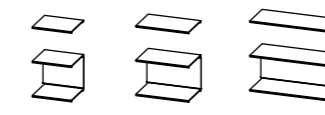

fianco esterno
external side

fianco interno di collegamento
joint side

cm 43
set 4 ripiani
4 shelves set

cm 58
set 4 ripiani
4 shelves set

cm 88
set 4 ripiani
4 shelves set

cm 43
set 4 ripiani
4 shelves set

cm 58
set 4 ripiani
4 shelves set

cm 88
set 4 ripiani
4 shelves set

0/71M-FE

0/71M-FI

0/71M2-R43

0/71M2-R58

0/71M2-R88

0/71M-R43

0/71M-R58

0/71M-R88

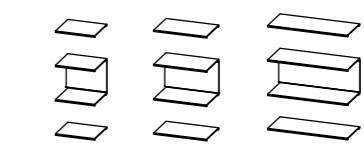
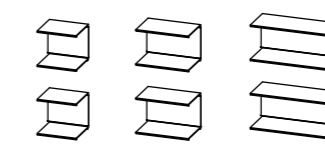
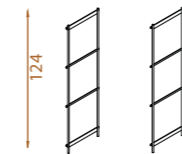

fianco esterno
external side

fianco interno di collegamento
joint side

cm 43
set 6 ripiani
6 shelves set

cm 58
set 6 ripiani
6 shelves set

cm 88
set 6 ripiani
6 shelves set

cm 43
set 6 ripiani
6 shelves set

cm 58
set 6 ripiani
6 shelves set

cm 88
set 6 ripiani
6 shelves set

cm 128
set 4 ripiani
4 shelves set

0/71A-FE

0/71A-FI

0/71A3-R43

0/71A3-R58

0/71A3-R88

0/71A-R43

0/71A-R58

0/71A-R88

0/71A-R128

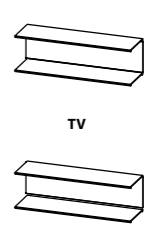
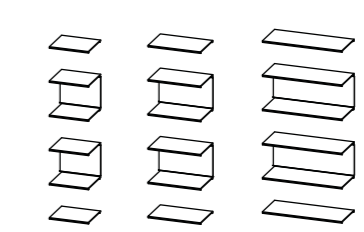
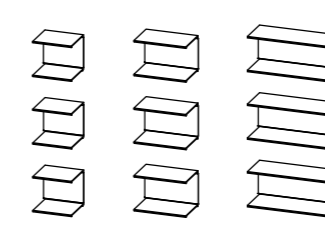
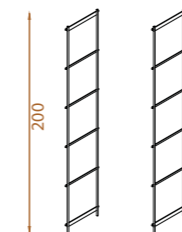

Design: Ghirardello

Step

Libreria di grande effetto decorativo con struttura in laminato Ecologico spessore mm 18-25, schienale in vetro trasparente temperato mm 10 ed elementi di fissaggio con finitura alluminio.

Smart bookcase, structure made of Eco-friendly laminate 18-25 mm thick, combined with an elegant back made of toughened clear glass 10 mm thick. Fixing components with aluminium finishing.



0/79
libreria
bookcase
cm 60x35x190h



per dividere gli
ambienti con
leggerezza

*the best way
to divide a
room with
lightness*



0/79
libreria
bookcase
cm 60x35x190h

Design: Pezzani

Space

Scrivania con struttura in vetro trasparente temperato spessore 10 mm. Ripiani e cassetto push&pull realizzati in laminato Ecologico spessore 25/18 mm. Particolari in alluminio.

Desk with structure made of toughened clear glass 10 mm thick. Shelves and push&pull drawer made of Eco-friendly laminate 25/18 mm. Aluminium accessories.



0/82

cm 120x60x77h



Design: Pezzani

Shape

Serie di tavolini realizzati con struttura in tondino pieno acciaio Ø 10 mm verniciato sablé.

Versione con ripiani in laminato ecologico spessore 12 mm

Series of small and coffee tables structure made of steel rods Ø 10 mm colored with sandblasted finishing.

Variant with eco-friendly laminate top 12 mm thick



0/230
tavolino con ripiano in laminato
coffee table with laminate top
cm Ø 70x53h



0/231
tavolino
coffee table
cm Ø 90x38h



0/232 - SHAPE
cm. 50×50×53h

0/233 - SHAPE
cm. 85×85×38h



0/234 - SHAPE
ripiano in vetro acidato decoro Fiore nero
frosted glass top black Flower decorated
cm 120×70×38h



dettaglio vetro acidato retro stampato in digitale FIORE su nero
detail of the frosted glass with black FLOWER digital printing on the back

Versione con ripiani vetro acidato
8 mm temperato retro stampato
in digitale con decori
MARMO e FIORI

Variant with frosted toughened glass
top 8 mm thick with digital printing
MARBLE and FLOWER decoration
on the back



Dettaglio vetro acidato extrachiaro
retro stampato in digitale Fiore su bianco
*Detail of the frosted glass with
white Flower digital printing on the back*



0/232 - SHAPE
ripiano in vetro acidato decoro Fiore nero
frosted glass top with black Flower decoration
cm 50x50x53h



0/233 - SHAPE
ripiano in vetro acidato decoro Fiore bianco
frosted glass top with white Flower decoration
cm 85x85x38h



0/230 - SHAPE
ripiano in vetro acidato decoro marmo Nero del Sahara
frosted glass top with black Sahara marble decoration
cm Ø 70x53h



0/231 - SHAPE
ripiano in vetro acidato decoro marmo Fiorentino bianco
frosted glass top with white Florentine marble decoration
cm Ø 90x38h

Design: Pezzani

Stone

Serie di tavolini realizzati con struttura in acciaio verniciato sablé. Versione con ripiani vetro acidato 8 mm temperato retro stampato in digitale con decori marmo.

Series of coffee tables with steel structure colored with sandblasted finishing. Version with top made of frosted toughened glass 8 mm thick with digital printing marble decoration on the back.



Dettaglio vetro acidato extrachiaro retro stampato in digitale marmo Fiorentino bianco.
Detail of the frosted extra-light clear glass with white Florentine marble digital printing on the back.



0/243
cm. 55x55x50h



0/244
cm. 85x85x35h



la straordinaria
bellezza del vetro
acidato decorato
marmo nero del
Sahara

*the precious frosted
glass black Sahara
marble decorated*

Design: Pezzani

Bridge

Consolle con struttura in acciaio verniciato sablé. Top in vetro temperato acidato da 8 mm retroverniciato tinta unita oppure retro stampato in digitale con decori marmo.

Console, structure made of sandblasted colored steel, top made of toughened frosted glass 8 mm thick with solid color or digital printing marble decorations on the back.



0/481
cm 120x30x90h

Design: Pezzani

Vogue

Tavolino multifunzioni che integra la funzione portariviste, realizzato in acciaio verniciato sablé.

Multipurpose table complete with magazine-rack, made of sandblasted colored steel.



0/21
cm. 40x50x60h



Design: Pezzani

Cube

Tavolino multifunzioni
struttura in acciaio verniciato
con finitura sablé e ripiano
centrale in laminato
Ecologico da 18 mm.

*Multipurpose table, structure
made of sandblasted colored
steel and middle shelf made
of Eco-friendly laminate 18
mm thick*



0/24
cm 50x50x58h



Design: Pezzani

Chef ^{new}

Carrelli cucina professionali
completi di cassetti e porta-bottiglie.
Struttura e ripiani in acciaio verniciato
con finitura sablé, top in laminato
rivestito da lamina in alluminio con
finitura acciaio satinato

*Professional kitchen carts
with drawers and bottle-holders.
Structure and shelves made of
sandblasted colored steel, laminate
top covered with aluminium foil
with brushed steel finishing.*



0/173
carrello cucina
kitchen cart
cm 81x46x87h



0/172
carrello cucina
kitchen cart
cm 46x46x86h

L'azienda si riserva il diritto di modificare od eliminare gli articoli contenuti in questo catalogo in qualsiasi momento senza preavviso. L'azienda è proprietaria esclusiva del catalogo e del materiale fotografico in essa contenuto; riproduzione vietata. I colori riportati nel catalogo sono solo indicativi e possono differire da quelli reali degli oggetti ai quali si riferiscono.

The company has the right to change or delete items from this catalogue without notice. Copyright notice: the company is the sole owner of this catalogue and its pictures; copies are strictly prohibited. The colors of this catalogue are only approximate, they can be different from the real ones.

fotografia:
ernesto pedroni

stampa:
grafiche sagi
reggio emilia 2019

PEZZANI SRL
Via Papini 33 - 43036 Fidenza (Parma) - Italia
tel. +39 0524 525440
fax +39 0524 526684
email: info@pezzani.eu