



Homy _ Notte

Armadi	Wardrobes
Letti	Beds
Gruppi	Ranges
Complementi	Complementary Units



Boleana

pag. 45 / 51



Inserto

pag. 37



Mod

pag. 69



Nuit

pag. 19 / 25



Profilo

pag. 55



Darsena

pag. 263



Esteta

pag. 271 / 276 / 279



Metal

pag. 247



Nocta

pag. 233 / 235 / 239



Tandem

pag. 255



Twin

pag. 287 / 295



Luxury

pag. 241



Double Scorrevole

pag. 227



Double Battente

pag. 213 / 223



Ego Scorrevole

pag. 179



Ego Battente

pag. 179 / 181 / 186 / 194 / 203 / 205



Fascia Scorrevole

pag. 143 / 161 / 167 / 171 / 172



Fascia Battente

pag. 149 / 151 / 153 / 173



Master Scorrevole

pag. 123



Master Battente

pag. 125 / 127



Liscia Scorrevole

pag. 97



Liscia Battente

pag. 79 / 87 / 89 / 105 / 233 / 303



Piana Scorrevole

pag. 111



Adam

pag. 273 / 275



Ander

pag. 23



Bali

pag. 219



Ghibli

pag. 201 / 211



Libeccio

pag. 117 / 121



Maistro Imbottito

pag. 169



Plinio

pag. 33 / 35



Scirocco

pag. 49 / 57



Duran

pag. 303



Grecale

pag. 253



Levante

pag. 109



Lotus

pag. 185



Maistro

pag. 167



Nashi

pag. 293



Parentesi

pag. 261



Tod

pag. 63 / 65



Wave

pag. 283

impiallacciati

Veneered beds



Espero

pag. 191 / 193



Talak

pag. 236

sistemi

Ranges



Scacco

pag. 135 / 139 / 141 / 147 / 157



Zefiro

pag. 81 / 93 / 101



Dolomite

pag. 33 / 39 / 211 / 215



Opale

pag. 291 / 299



Quadro 12

pag. 219 / 225 / 226



Quadro Darsena

pag. 267



Quadro Filo

pag. 235 / 237 / 249 / 251



Onice

pag. 271 / 277 / 279



Quarzo

pag. 305 / 307



Spot Mix

pag. 283 / 284



Sistema Cobalto

pag. 45 / 47 / 63 / 69 / 71



Sistema Diciotto

pag. 93 / 96 / 101 / 113 / 117 / 137 / 143 / 159 / 170



Sistema Ego

pag. 181 / 183 / 185 / 187 / 193 / 195 / 203 / 207



**“Cambiamo
il punto di vista,
trasformando
elementi contenitivi
da oggetti marginali
di una stanza
in spazi modulabili
in cui vivere
la nostra quotidianità.”**

—
“We change our point of view of transforming storage elements from marginal objects in a room into modular spaces in which to inhabit our daily lives.”

sezione _ scorrevoli

Section _ Sliding doors

pag. 14 - 15

sezione _ scorrevoli + battenti

Section _ Sliding doors + hinged doors

pag. 72 - 73

sezione _ battenti

Section _ Hinged doors

pag. 228 - 229

sezione _ tecnica

Section _ Technical information

pag. 308 - 309

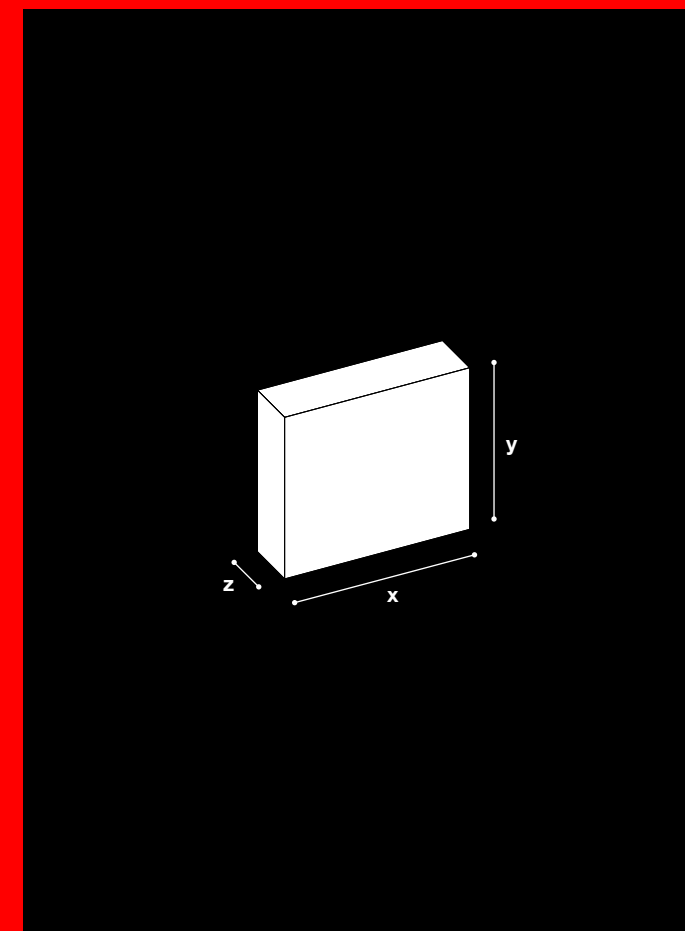

IT_

Guida alla comprensione del catalogo.

Tre sezioni funzionali: area Ante Scorrevoli, Area mista dove nello stesso stile troverete Ante Battenti e Scorrevoli perfettamente coerenti ed affiancabili tra loro ed infine l'area Ante Battenti.

Tre anche i contesti stilistici: ambienti classici per le ante Scorrevoli, Ante miste negli ambienti moderni ed infine per gli ambienti ristrutturati le Ante Battenti. Colori e materiali consentono in ogni caso chiavi di lettura diverse da quelle proposte. Potremmo dunque affermare che è nello studio della "funzione" che dipende il rendimento, ma è nello "stile" che si manifesta.

EN_

How to use this catalogue.

Three functional sections: the sliding doors section, the mixed section (hinged and sliding doors in the same style you can use together) and the hinged doors section.

Three styles: sliding doors for traditional spaces, mixed doors for modern spaces and hinged doors for renovated spaces. Colours and materials can also be used to interpret products in other new ways. The overall look depends on the function but comes through in the style.

sezione _ **scorrevoli**

Section _ Sliding doors

001_

ELEGANCE

MOOD

IT_

Un'atmosfera calda e accogliente caratterizza questo primo mood. Ambientazioni classiche e sobrie che ben si sposano con la contemporaneità mai urlata dei prodotti Homy. Eleganza e charme per ambienti che devono durare nel tempo: lo stile è gusto e cultura.

EN_

The first "mood" creates a warm and welcoming atmosphere. A classic and sober setting combines perfectly with Homy's quietly contemporary products. Elegant charm creates timeless spaces in which style is taste and culture.



MAPPA STANZA

Room plan

Location _ 001

Stanza _ **A** + Disimpegno _ **B**

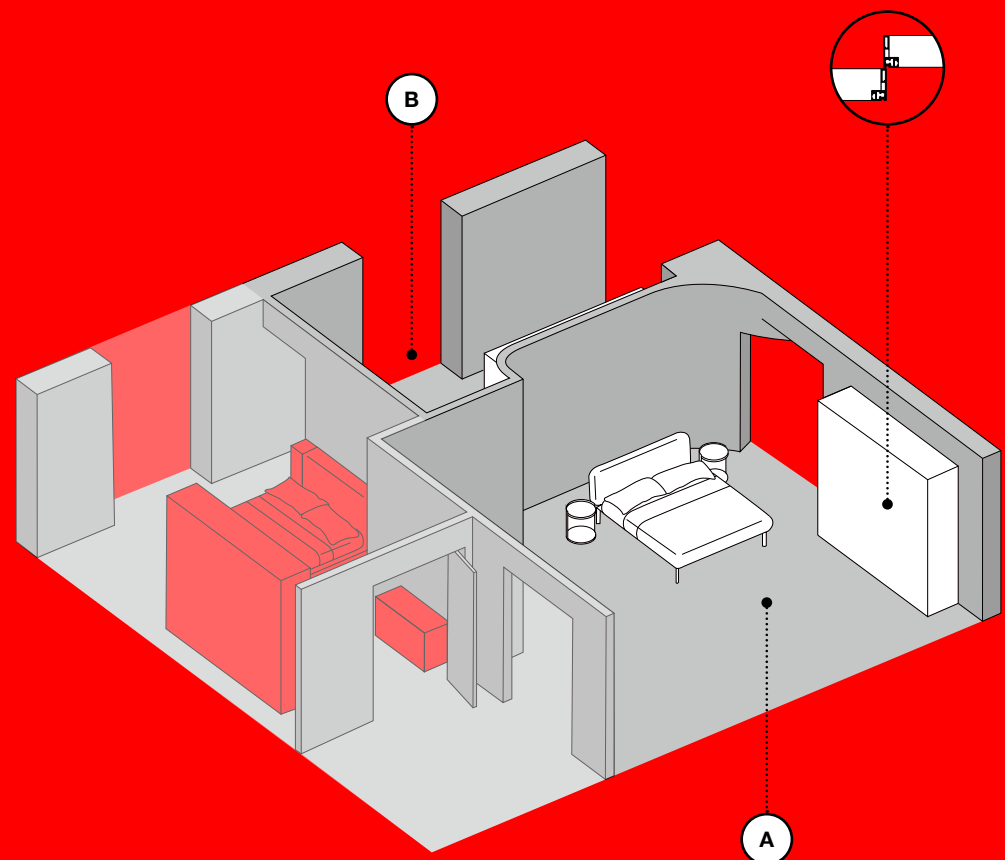

A Stanza A _ Letto **ANDER** _ Armadio ante scorrevoli **NUIT** _ Tavolino **MICHELANGELO**
Room A _ ANDER bed _ NUIT sliding-door wardrobe _ MICHELANGELO occasional table

B Disimpegno B _ Armadio ante scorrevoli **NUIT**
Hallway B _ NUIT sliding-door wardrobe

Mood Materico
Textured moods



Letto _ ANDER

Bed _ ANDER

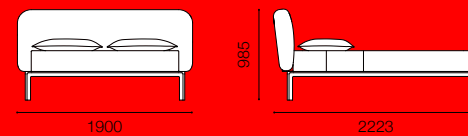

Testiera _ TX Roma 13
Headboard _ TX Roma 13

Ring _ ES Matwood Dark
Frame _ ES Matwood Dark

Armadio ante scorrevoli _ NUIT

Sliding-door wardrobe _ NUIT

P. | D. _ 694

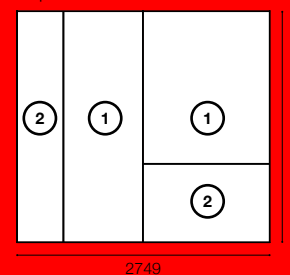

Scocca _ ES Matwood Dark
Body _ ES Matwood Dark

1 **Settore 1 _ VS Stopsol**
Section 1 _ VS Stopsol

Telaio Anta _ VM Titanio
Door Frame _ VM Titanio

2 **Settore 2 _ LM Travertino**
Section 2 _ LM Travertino

Armadio ante scorrevoli _ NUIT

Sliding-door wardrobe _ NUIT

P. | D. _ 694

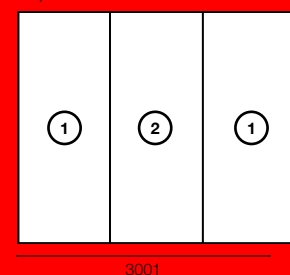

Scocca _ ES Matwood Dark
Body _ ES Matwood Dark

1 **Settore 1 _ VS Stopsol**
Section 1 _ VS Stopsol

Telaio Anta _ VM Titanio
Door Frame _ VM Titanio

2 **Settore 2 _ VS Bronzo**
Section 2 _ VS Bronzo

Tavolino _ MICHELANGELO

Occasional table _ MICHELANGELO

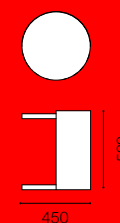

Struttura _ VM Black
Frame _ VM Black

Piano _ LM Travertino
Top _ LM Travertino





IT_

L'anta Nuit è un sistema. Il telaio in alluminio in finitura titanio è una sezione minimalista ed equilibrata nelle proporzioni che consente una segmentazione modulare dell'anta secondo schemi visibili a listino. Nell'ambientazione è proposto con l'anta centrale in specchio Bronzo e nelle ante laterali in vetro Stop Sol per assecondare lo stile un po' bohémien della villa: non classica e non moderna.

EN_

The Nuit door can be used to create an entire range of looks and effects. The aluminium frame in the Titanio finish is a minimalist, balanced part of the door's proportions, allowing you to divide it up into separate modules which can be designed as shown in the price list. On location, we opted for the central door in Bronzo mirror and the side doors in Stopsol glass, to fit the villa's bohemian style accent that is neither traditional nor modern.







Dimensioni: L.2749 H.2530 P.694
 Size: W.2749 H.2530 D.694

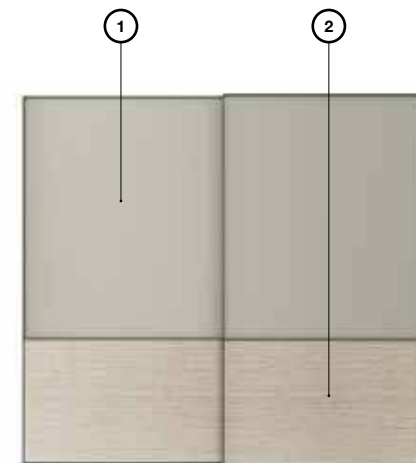

- ① **Settore 1 _ LO Limo**
Section 1 _ LO Limo
- ② **Settore 2 _ LM Travertino**
Section 2 _ LM Travertino
- Telaio anta _ VM Titanio**
Door Frame _ VM Titanio

Dimensioni: L.3001 H.2530 P.694
 Size: W.3001 H.2530 D.694

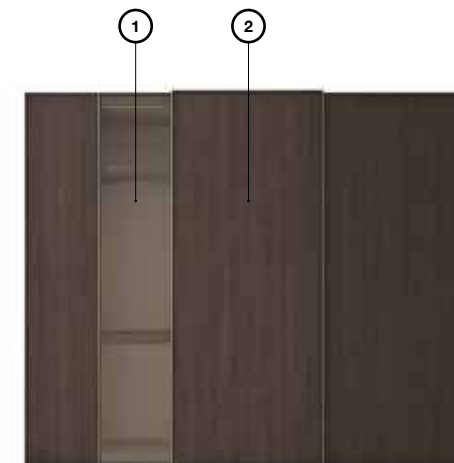

- ① **Settore 1 _ VS Stopsol**
Section 1 _ VS Stopsol
- ② **Settore 2 _ ES Matwood Dark**
Section 2 _ ES Matwood Dark
- Telaio anta _ VM Titanio**
Door Frame _ VM Titanio

Dimensioni: L.2749 H.2530 P.694
 Size: W.2749 H.2530 D.694

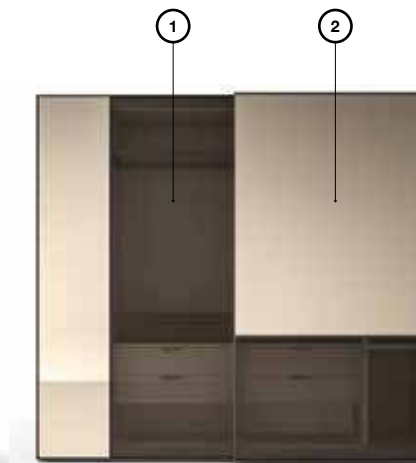

- ① **Settore 1 _ VS Stopsol**
Section 1 _ VS Stopsol
- ② **Settore 2 _ VS Bronzo**
Section 2 _ VS Bronzo
- Telaio anta _ VM Titanio**
Door Frame _ VM Titanio

IT_

Nuit è forse il paradigma di cosa intendiamo per equilibrio tra "stile" e "funzione". Il telaio consente una segmentazione dell'anta in settori orizzontali o verticali. Questa possibilità agevola un gioco estetico tra materiali e finiture diverse assolvendo la volontà di avere un armadio elegante e non stravagante.

EN_

Nuit is perhaps the paradigm of what we mean by balancing style and function. The frame divides the door into horizontal or vertical sections. This allows you to play with different materials and finishes to create an elegant look that is not too outlandish.



IT_

Una ricca gamma di allestimenti e divisori che permettono di modulare a proprio piacimento l'armadio. Da elementi di razionalizzazione questi complementi diventano elementi decorativi che ridefiniscono il linguaggio estetico dei nostri armadi.

EN_

The wide range of fittings and partitions mean you can build the wardrobe just how you want it. More than simply organisers for the space, these fittings are decorative elements that redefine the way your wardrobe looks.

MAPPA STANZA

Room plan

Location _ 001

Stanza _ C

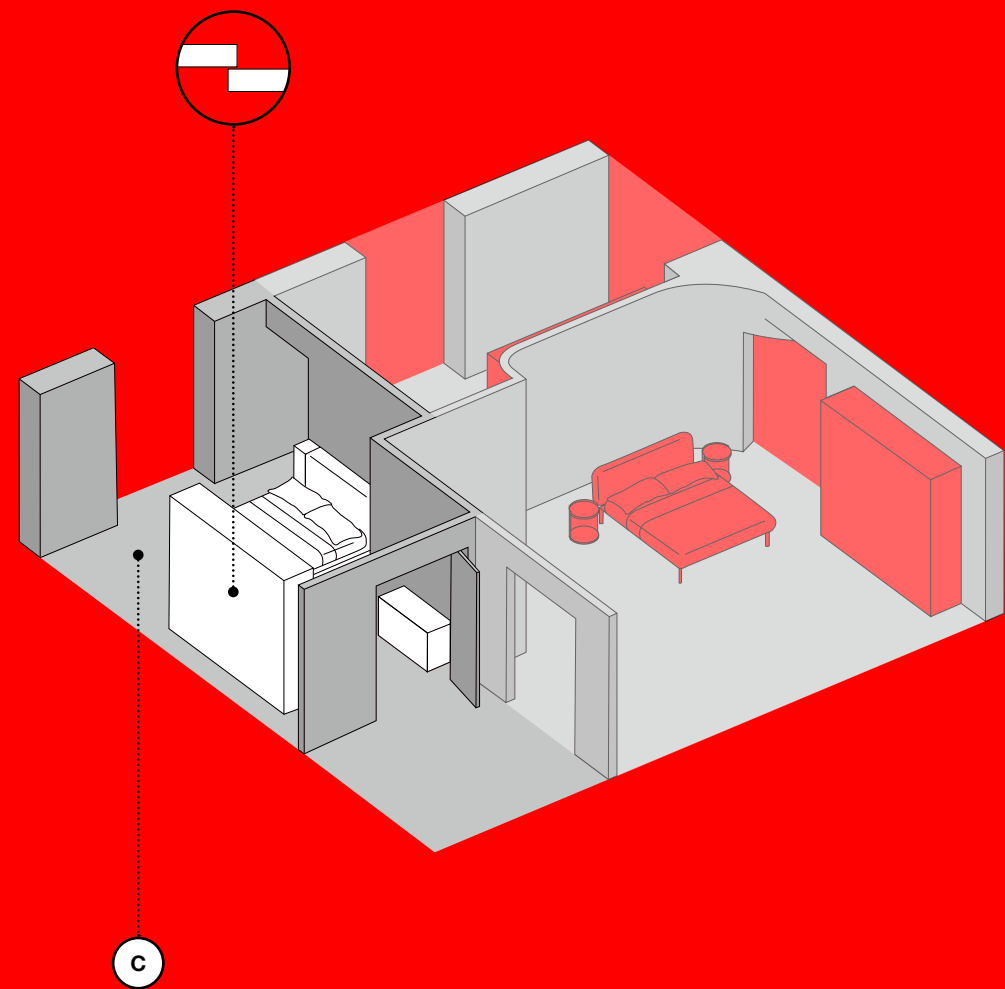

- 30 -

- 31 -

C

Stanza C _ Letto PLINIO _ Armadio ante scorrevoli INSERTO _ Collezione DOLOMITE _ Specchiera MEDUSA
 Room C _ PLINIO bed _ INSERTO sliding-door wardrobe _ DOLOMITE collection _ MEDUSA mirror

Mood materico
 Textured moods



Letto _ PLINIO

Bed _ PLINIO

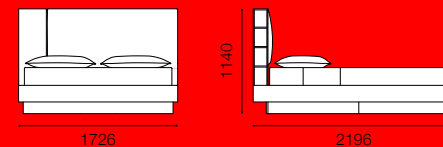

Testiera _ TX Roma 22
 Headboard _ TX Roma 22

Ring _ ES Matwood Grey
 Frame _ ES Matwood Grey

Armadio ante scorrevoli _ INSERTO

Sliding-door wardrobe _ INSERTO

R | D. _ 654

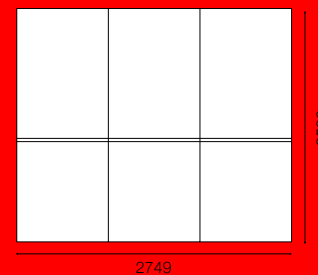

Scocca _ CE Limo
 Body _ CE Limo

Anta _ CE Limo
 Door _ CE Limo

Inserto _ ES Matwood Grey
 Insert _ ES Matwood Grey

Collezione _ DOLOMITE

Collection _ DOLOMITE

R | D. _ 402 R | D. _ 489 R | D. _ 402

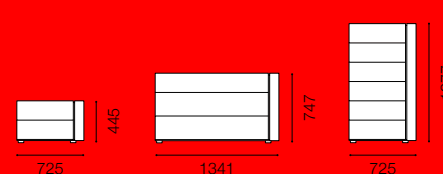

Scocca _ CE Limo
 Body _ CE Limo

Frontale _ CE Limo
 Front _ CE Limo

Fiancone _ MT Limo
 Large side panel _ MT Limo

Specchiera _ MEDUSA

Mirror _ MEDUSA

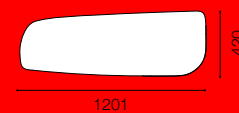

Specchio _ SS Argento
 Mirror _ SS Argento

Struttura _ VM Black
 Frame _ VM Black





IT_

Plinio è nato con l'ambizione di servire chi, avendo poco spazio in camera, non vuole rinunciare alla comodità di un letto matrimoniale dalle dimensioni generose. Questo letto infatti integra alla propria testiera un vano a giorno capiente che sostituisce il secondo comodino, diminuendo in questo modo lo spazio d'ingombro dell'insieme. È caratterizzato dalle gambe asimmetriche nere opache e da un profilo in Titanio che caratterizza anche il gruppo Dolomite.

EN_

Plinio was designed for people with a small bedroom space but who don't want to compromise on the comfort of a large double bed. This bed has a practical open compartment built into the headboard, which replaces the second bedside table, taking up less overall space. It has matt black asymmetrical legs and a profile in the Titanio finish that also features in the Dolomite collection.





38



39

IT_

Il fiancone che caratterizza il gruppo Dolomite, qui lo vediamo proposto in finitura Concrete Limo, che richiama gli effetti di spatolatura cementizia coordinandosi cromaticamente al resto del mobile in finitura Eco Limo. Lo specchio Medusa è una specchiera dalle forme sinuose assecondate su un lato da una piccola mensola funzionale a svuotare le tasche o a piccoli oggetti decorativi.

EN_

The same large side panel from the Dolomite collection features here in the Concrete Limo finish. This finish recreates the effect of a cement spatula application and coordinates with the rest of the furniture in the Eco Limo finish. The Medusa mirror has a curvaceous form with a handy little shelf fitted to one side, for decorative trinkets or oddments.

**MAPPA
STANZA**

Room plan

Location _ 002

Stanza _ **D**

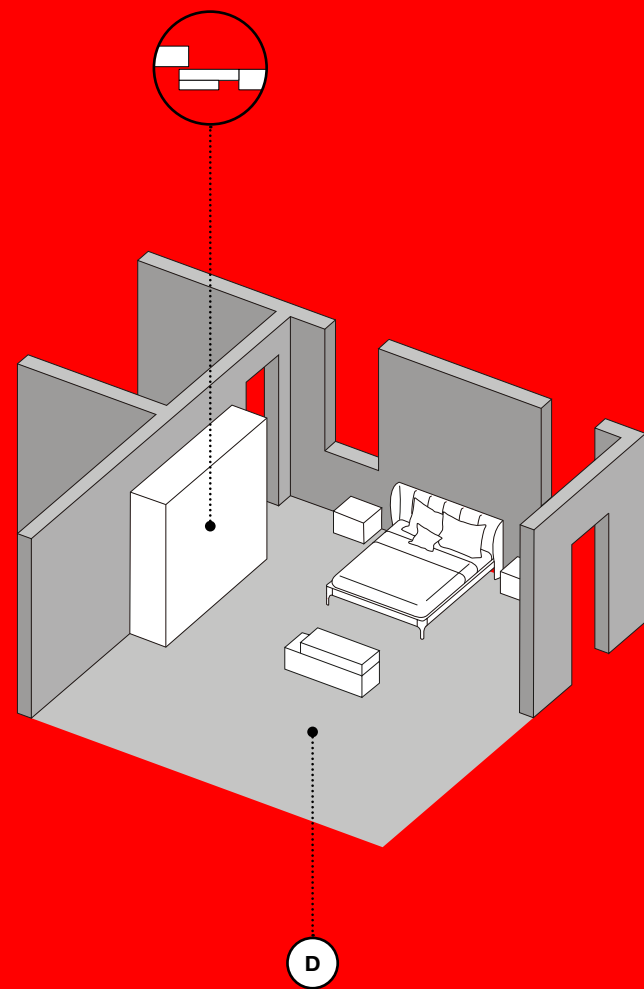

Letto _ SCIROCCO

Bed _ SCIROCCO

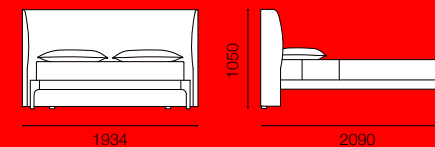

Testiera _ TX Milano 09
Headboard _ TX Milano 09

Ring _ ES Matwood Coffee
Frame _ ES Matwood Coffee

Armadio ante scorrevole _ BOLEANA

Sliding-door wardrobe _ BOLEANA

P. | D. _ 654

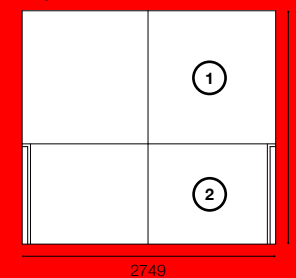

Scocca _ LO Ecrù
Body _ LO Ecrù

1 Anta 1 _ LO Ecrù
Door 1 _ LO Ecrù

2 Anta 2 _ ES Matwood Coffee
Door 2 _ ES Matwood Coffee

Sistema Componibile _ COBALTO

Modular range _ COBALTO

P. | D. _ 488 P. | D. _ 488 P. | D. _ 488

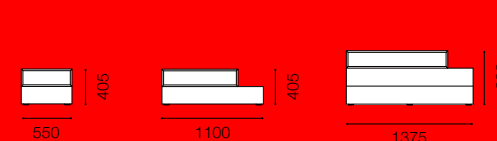

Scocca _ LO Ecrù
Body _ LO Ecrù

Frontale _ LO Ecrù
Front _ LO Ecrù

Vani a giorno _ ES Matwood Coffee
Open compartments _ ES Matwood Coffee

D Stanza D _ Letto SCIROCCO _ Armadio ante scorrevoli BOLEANA _ Sistema Componibile COBALTO _ Specchiera FREJA
Room D _ SCIROCCO bed _ BOLEANA sliding-door wardrobe _ COBALTO modular range _ FREJA mirror

Specchiera _ FREJA

Mirror _ FREJA

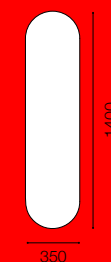

Specchio _ SS Argento
Mirror _ SS Argento

Mood materico
Textured moods

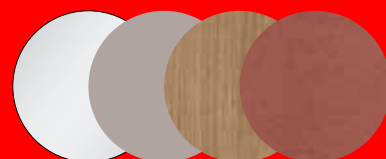

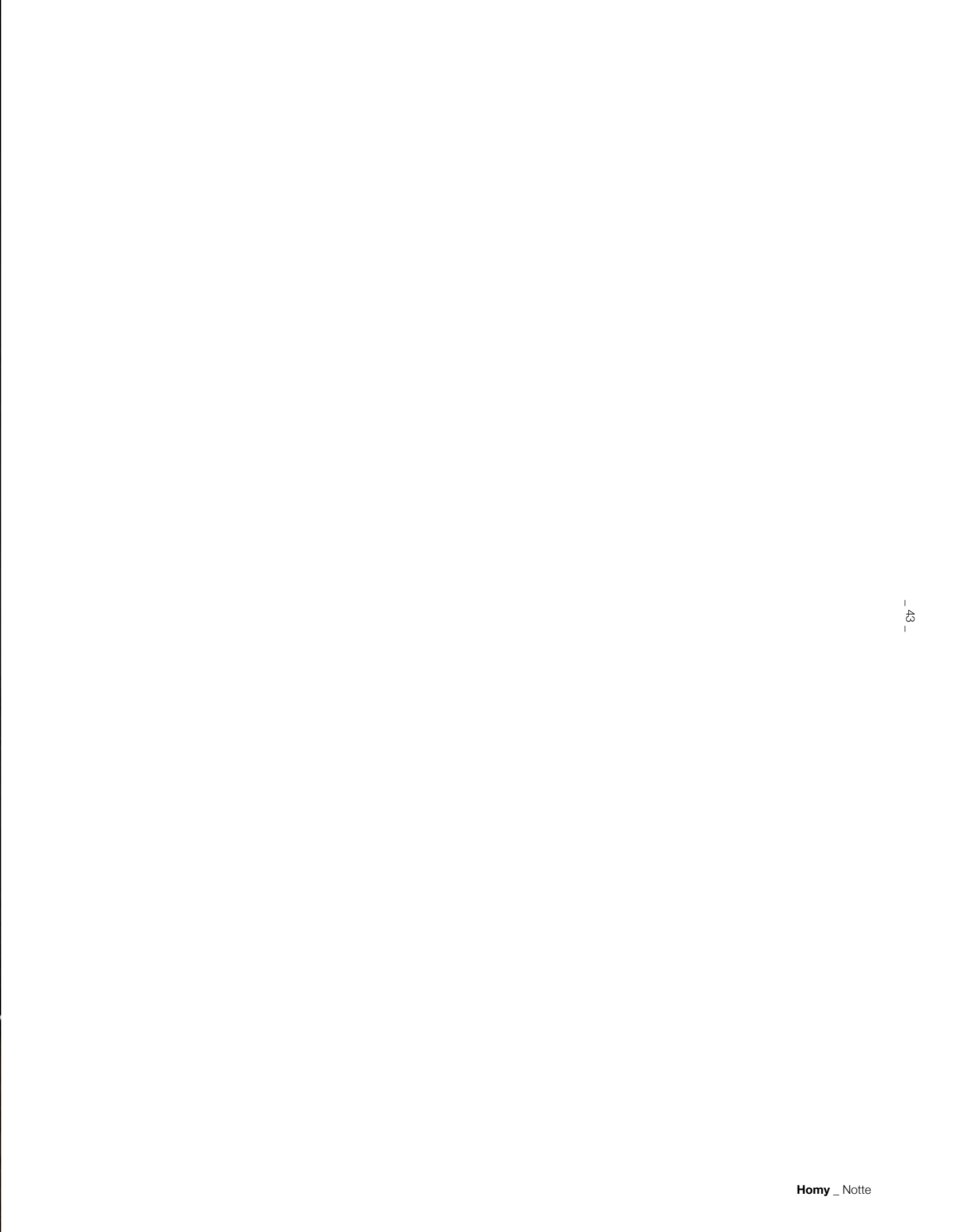



Dimensioni: L.1650 H.791 P.488
Size: W.1650 H.791 D.488

Dimensioni: L.550 H.590 P.488
Size: W.550 H.590 D.488

 **Scocca e Frontali _ LO Mosto**
Body and Fronts _ LO Mosto

 **Piedini _ VM Black**
Feet _ VM Black

Dimensioni: L.550 H.1217 P.488
Size: W.550 H.1217 D.488

 **Scocca e Frontali _ CE Limo**
Body and Fronts _ CE Limo

- 46 -



IT_

Cobalto è uno dei tre sistemi componibili della collezione Homy. La modularità è ampia e versatile tanto da permettere soluzioni sia asimmetriche che rigorosamente allineate. Gli elementi di questo sistema possono essere alzati da terra tramite l'utilizzo di piedini in finitura nera opaca, trasformando un comò in una madia o in un mobile porta Tv piacevole e funzionale in molti ambienti della casa.

EN_

Cobalto is one of the three modular ranges in the Homy collection. The units are highly modular and versatile, for creating both asymmetric and perfectly aligned solutions. The pieces in the range can also be lifted off the floor with matt black feet, transforming a dresser into a sideboard or a practical and pretty TV stand, in many different rooms in the house.

- 47 -





48

49

IT_

Il letto Scirocco nella versione sospesa su piedi integrati al giroletto. Un'ampia gamma di tessuti ed ecopelli permette un'interpretazione stilistica molto diversa, ragione per cui Scirocco è un letto bello in ogni ambiente.

EN_

The Scirocco bed also comes in a suspended version, on feet integrated in the bed frame. There is a wide range of fabrics and eco-leathers to choose from, allowing for very different stylistic interpretations. This is why Scirocco is a beautiful bed for any environment.



- 50 -

IT_

Boleana è un'anta scorrevole dalle linee semplici, essenziali ma allo stesso tempo riconoscibili. La presa è ricavata nell'anta stessa e il suo segno divide lo specchio dell'anta in due sezioni caratterizzabili con finiture in contrasto oppure in accordo tonale. Questa possibilità permette di coordinare con sobrietà l'armadio agli altri elementi della camera.

EN_

Boleana is a sliding door with sleek and simple yet distinctive lines. The grip is carved into the door itself and divides it into two sections, which can be customised in contrasting or matching finishes. This makes it easy for you to coordinate the wardrobe with the other elements in the room.

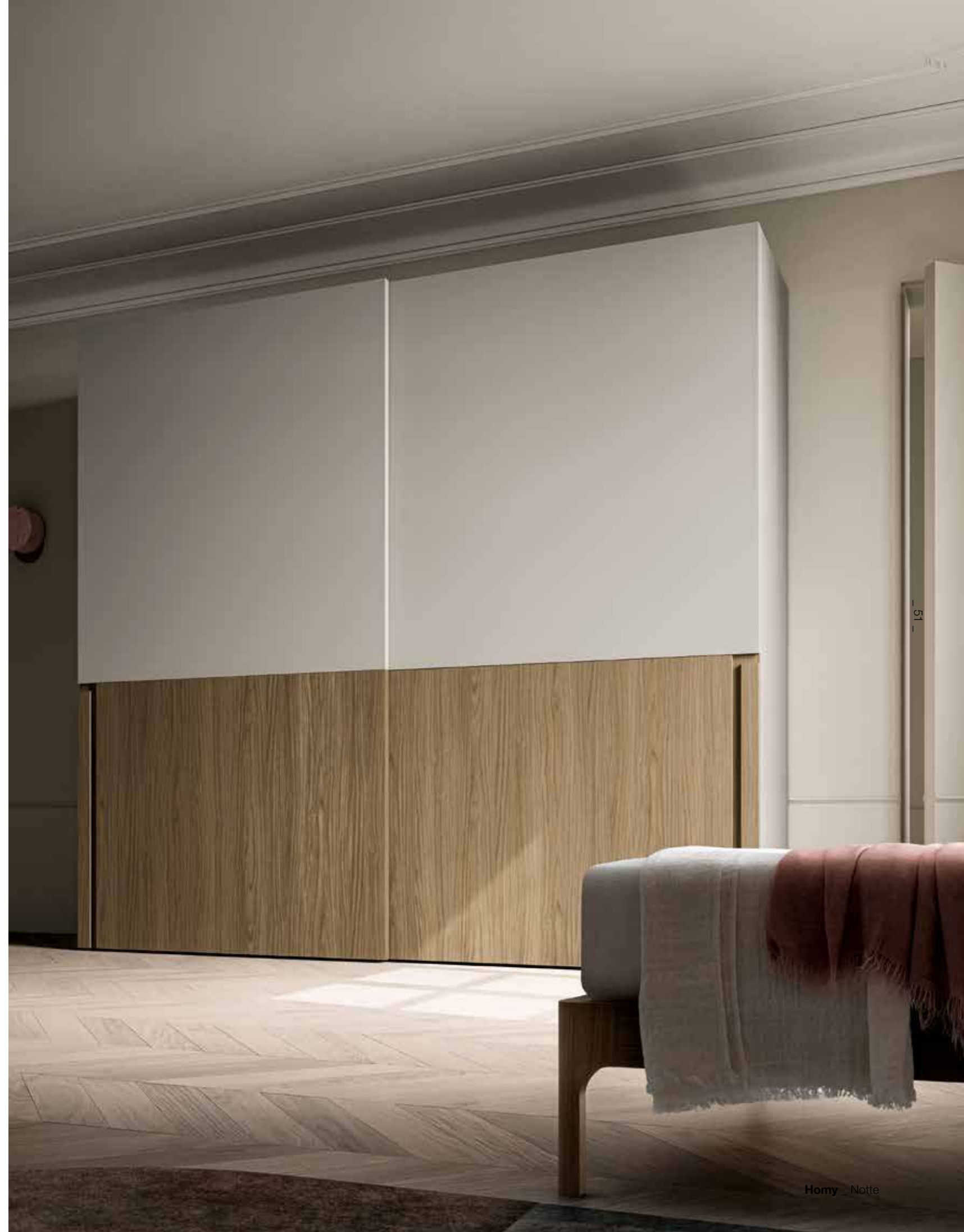

- 51 -

MAPPA STANZA

Room plan

Location _ 003

Stanza _ E

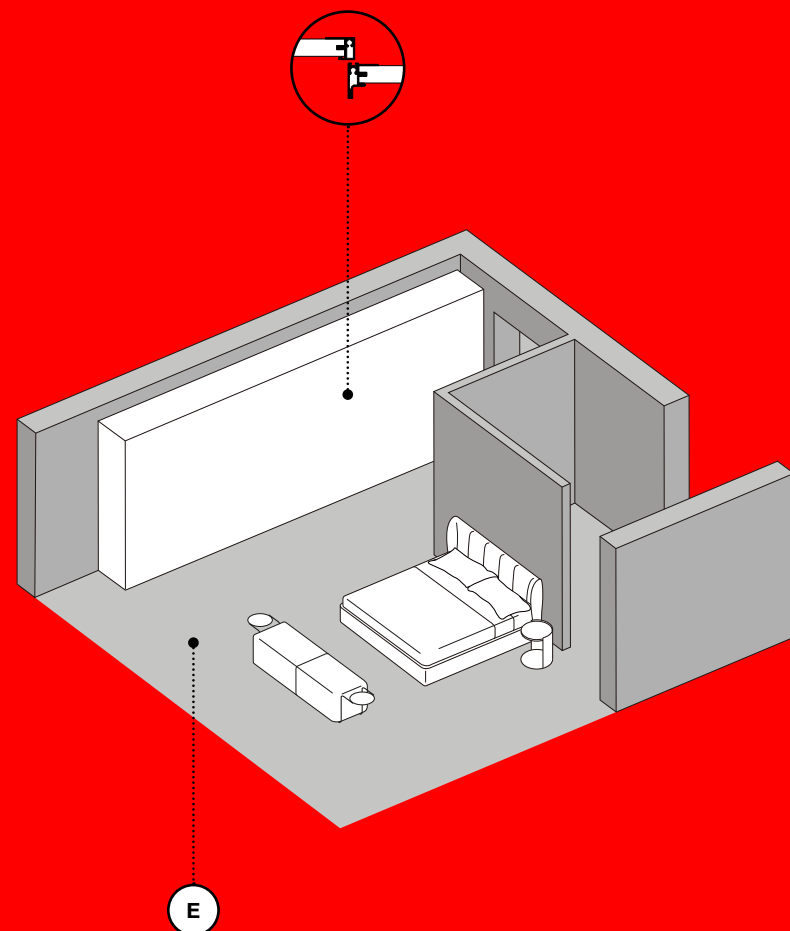

Mood materico
Textured moods



Letto _ SCIROCCO

Bed _ SCIROCCO

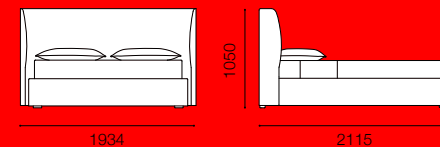

Testiera _ TX Bari 80
Headboard _ TX Bari 80

Ring _ TX Bari 80
Frame _ TX Bari 80

Armadio ante scorrevoli _ PROFILO

Sliding-door wardrobe _ PROFILO

P. | D. _ 657

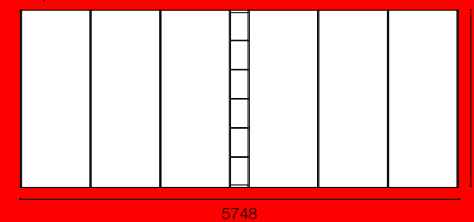

Scocca _ CE Bianco
Body _ CE Bianco

Anta _ CE Bianco
Door _ CE Bianco

Alveare _ ES Matwood Grey
Divider _ ES Matwood Grey

Tavolino _ MICHELANGELO

Occasional table _ MICHELANGELO

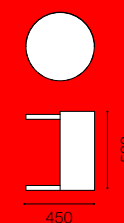

Piano _ LM Navajo Gold
Top _ LM Navajo Gold

Struttura _ VM Black
Frame _ VM Black

Pouf _ MONDRIAN RETTANGOLARE CON TAVOLINO

Footstool _ MONDRIAN

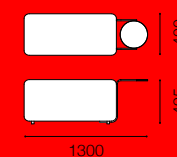

Pouff _ TX Venezia 27
Footstool _ TX Venezia 27

Piano _ LM Navajo Gold
Top _ LM Navajo Gold

Struttura _ VM Black
Frame _ VM Black

Specchiera _ DIANA

Mirror _ DIANA

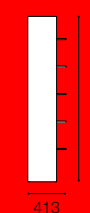

Struttura _ ES Matwood Grey
Frame _ ES Matwood Grey

Specchio _ SS Argento
Mirror _ SS Argento

E Stanza E _ letto SCIROCCO _ Armadio ante scorrevoli PROFILO _ Tavolino MICHELANGELO _ Specchiera DIANA _ Pouf MONDRIAN
Room E _ SCIROCCO bed _ PROFILO sliding-door wardrobe _ MICHELANGELO occasional table _ DIANA mirror _ MONDRIAN footstool





IT_

Il letto Scirocco nella soluzione a terra può ospitare il vano contenitore al quale si può accedere alzando rete/materasso con il pratico meccanismo a doppia alzata: una per riporre gli oggetti, l'altra per riassetare comodamente il letto.

EN_

The Scirocco bed in the floor-standing version can accommodate a storage compartment. To access it, lift up the bed base/mattress using the practical two-tier lift mechanism: one for storing things away and the other for conveniently making the bed.



IT_

Mondrian è un pouf disponibile in due misure che può essere utilizzato come panca alla base del letto oppure come oggetto libero. È possibile accessoriarlo con due elementi funzionali: con un piccolo piano svuotatasce in Lamina oppure con il portariviste in pelle rigenerata nabuk. Il profilo degli accessori è sempre nero opaco.

EN_

The Mondrian footstool comes in two sizes and can be used either as a bench at the end of the bed or as a free-standing unit. You can accessorise it with two functional features: a small Lamina occasional table or a magazine rack in nabuk bonded leather. The frame profile comes in matt black.



**MAPPA
STANZA**

Room plan

Location _ 004

Stanza _ F

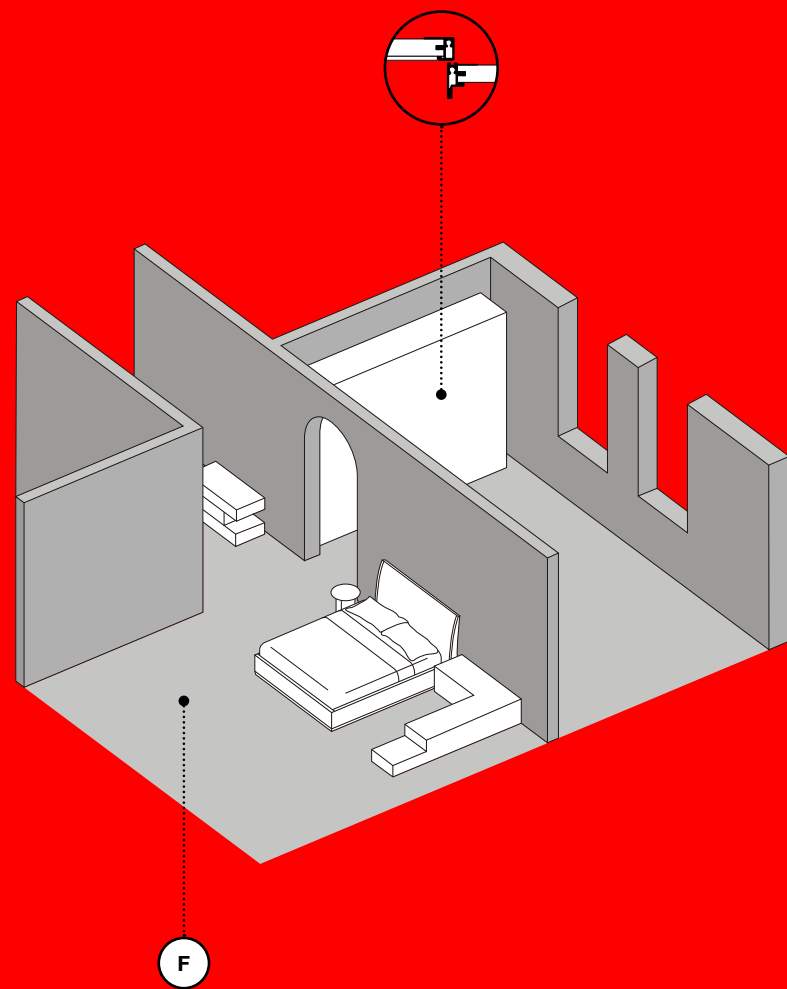

— 60 —

— 61 —

F

**Stanza F _ Letto TOD _ Armadio ante scorrevoli MOD _ Sistema Componibile COBALTO _ Tavolino PICASSO _
Appendiabiti MATISSE**
Room F _ TOD bed _ MOD sliding-door wardrobe _ COBALTO modular range _ PICASSO occasional table _ MATISSE clothes hanger

Mood materico
Textured moods



Letto _ TOD

Bed _ TOD

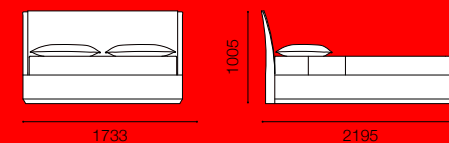

Testiera _ ES Matwood Grey
Headboard _ ES Matwood Grey

Ring _ ES Matwood Grey
Frame _ ES Matwood Grey

Armadio ante scorrevoli _ MOD

Sliding-door wardrobe _ MOD

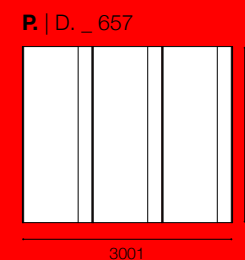

Scocca _ CE Marna
Body _ CE Marna

Anta _ CE Marna
Door _ CE Marna

Fascia _ SS Argento
Insert _ SS Argento

Sistema Componibile _ COBALTO

Modular range _ COBALTO

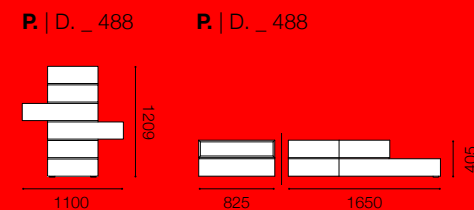

Scocca _ CE Marna
Body _ CE Marna

Frontale _ CE Marna
Front _ CE Marna

Tavolino _ PICASSO

Occasional table _ PICASSO



Struttura _ Stopsol con serigrafia a sfumare
Frame _ stopsol with to fade silkscreen.

Appendiabiti _ MATISSE

Clothes hanger _ MATISSE

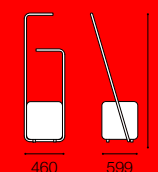

Pouff _ TX Venezia 014
Footstool _ TX Venezia 014

Struttura _ VM Black
Frame _ VM Black







IT_

Homy propone originali tavolini in vetro fumè in alternativa ai classici comodini. Picasso è caratterizzato da una stampa sfumata nelle tonalità del rosso bordeaux. La perdita di trasparenza per effetto della stampa progressivamente coprente gioca un ruolo estetico voluto nella dinamica degli oggetti stessi.

EN_

Homy offers original smoked-glass occasional tables as an alternative to traditional bedside tables. Picasso features a nuanced print in shades of burgundy red. The gradual loss of transparency created by the progressively more opaque print is deliberate and important for the look of the table and the dynamics of the pieces in the room.





Dimensioni: L.1100 H.1217 P.488
Size: W.1100 H.1217 D.488

Scocca e Frontali _ CE Marna
Body and Fronts _ CE Marna

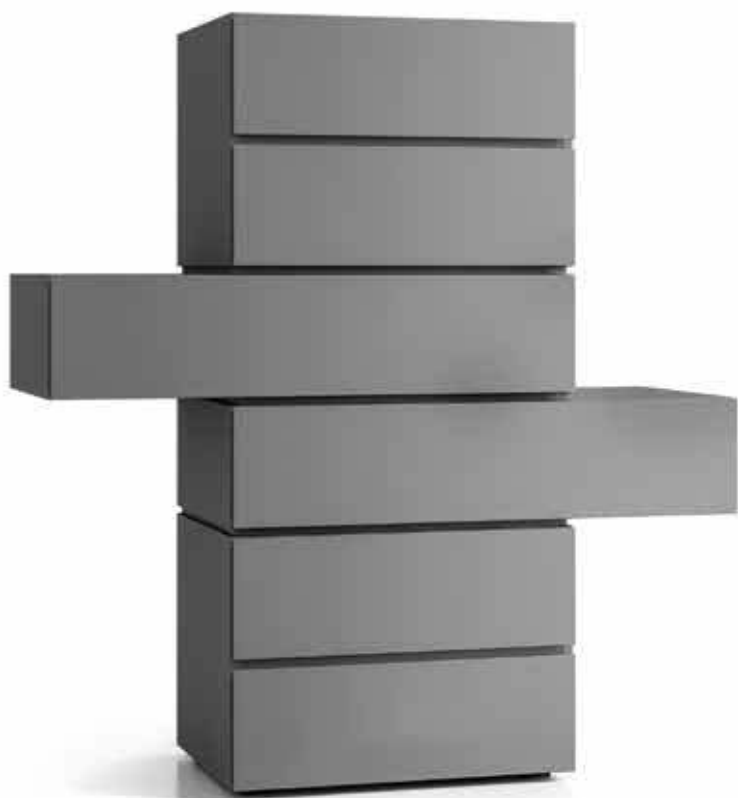

- 70 -

Dimensioni: L.1375 H.614 P.488
Size: W.1375 H.614 D.488

Scocca e Frontali _ LO Basalto
Body and Fronts _ LO Basalto



IT_

La praticità di un "sistema" sta nel sfruttare la sua modularità per creare le soluzioni più congeniali alle esigenze di ognuno. Talvolta può risultare stimolante sperimentare anche soluzioni meno rigorose dove la forma ridefinisce le funzioni creando, come in questo caso, piani d'appoggio aggiuntivi.

EN_

The practical benefits of a product range lie in exploiting its modular build to create solutions to suit everyone's needs. Sometimes it can be fun to experiment even with less structured solutions, letting the shape redefine the function. Take the additional shelves created here.



- 71 -

sezione _ **scorrevoli + battenti**

Section _ Sliding doors + hinged doors

002_

CONTEMPORARY

MOOD

IT_

Dal classico al contemporaneo, due contestualizzazioni opposte ma all'interno delle quali i prodotti Homy definiscono uno stile. Il mood contemporaneo presenta una serie di stanze dalle dimensioni più contenute e altre dalle dimensioni generose: in entrambe le situazioni Homy ottimizza lo spazio che gli viene riservato in un connubio tra estetica e funzionalità sempre equilibrato.

EN_

From classic to contemporary, two opposing contexts in which Homy products can define your style. The Contemporary Mood presents a series of smaller rooms and other larger ones. In both cases, Homy optimises the available space, balancing aesthetics and functionality.



**MAPPA
STANZA**

Room plan

Location _ 001

Stanza _ **A** + Disimpegno _ **B**

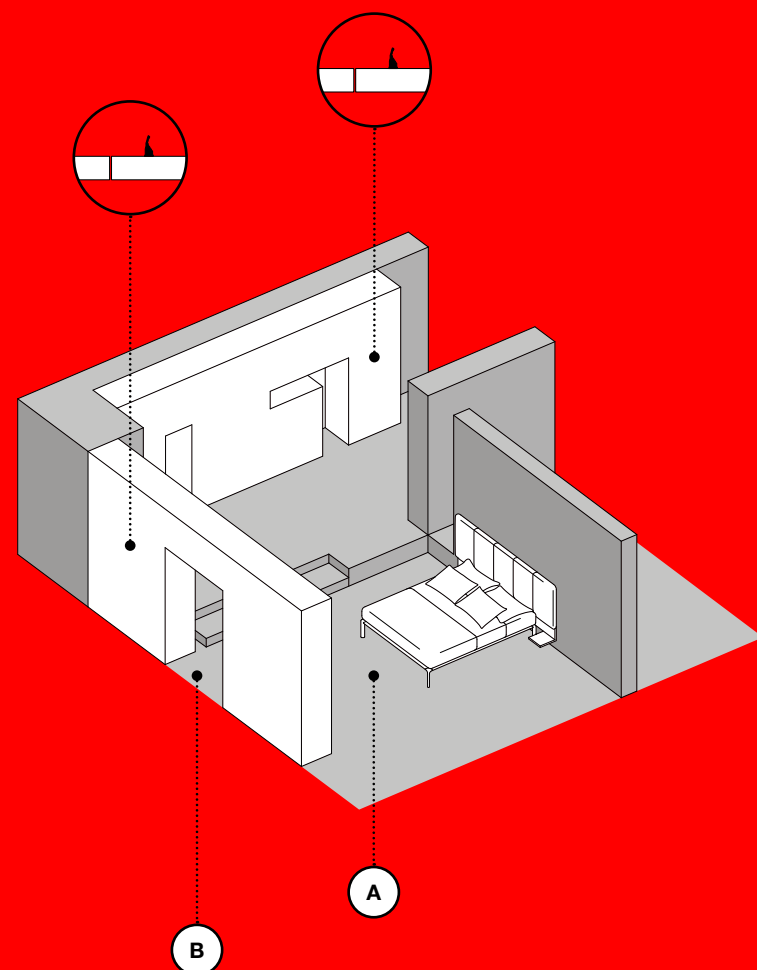

A Stanza A _ Letto ZEFIRO _ Armadio ante battenti LISCIA _ Specchiera DIANA
Room A _ ZEFIRO bed _ LISCIA hinged-door wardrobe _ DIANA mirror

B Disimpegno B _ Armadio ante battenti LISCIA
Hallway B _ LISCIA hinged-door wardrobe

Mood materico
Textured moods



Letto _ ZEFIRO

Bed _ ZEFIRO

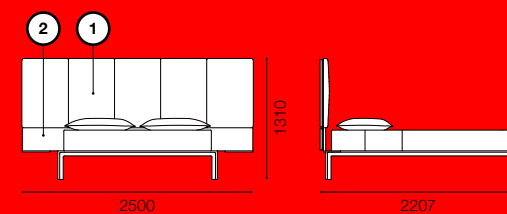

1 Testiera 1 _ TX Venezia 204
Headboard 1 _ TX Venezia 204

2 Testiera 2 _ ES Matwood Coffee
Headboard 2_ ES Matwood Coffee

Ring _ ES Matwood Coffee
Frame _ ES Matwood Coffee

Armadio ante battenti _ LISCIA

Hinged-door wardrobe _ LISCIA

P | D. _ 602

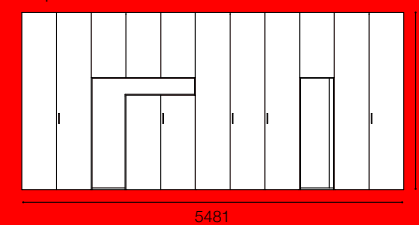

Scocca _ CE Limò
Body _ CE Limò

Anta _ CE Limò
Door _ CE Limò

Vani a giorno _ LO Verde Ombra
Open Compartments _ LO Verde Ombra

Armadio ante battenti _ LISCIA

Hinged-door wardrobe _ LISCIA

P | D. _ 602

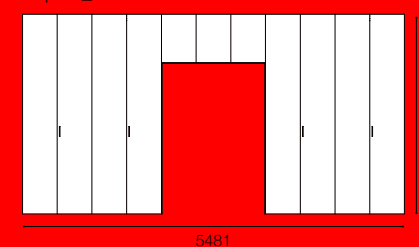

Scocca _ CE Limò
Body _ CE Limò

Anta _ CE Limò
Door _ CE Limò

Ponte _ ES Matwood Coffee
Bridging Unit _ ES Matwood Coffee

Specchiera _ DIANA

Mirror _ DIANA

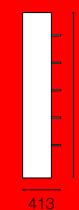

Specchio _ SS Argento
Mirror _ SS Argento

Struttura _ ES Matwood Coffee
Frame _ ES Matwood Coffee







Dimensioni: L.2500 H.1310 P.2201
 Size: W.2500 H.1310 D.2201

 **Testiera _ TX Venezia 204**
 Headboard _ TX Venezia 204

 **Testiera e Ring _ ES Matwood Coffee**
 Frame and Headboard _ ES Matwood Coffee



Dimensioni: L.2000 H.1310 P.2151
 Size: W.2000 H.1310 D.2151



Dimensioni: L.1000 H.1310 P.2151
 Size: W.1000 H.1310 D.2151



IT_

Il sistema Zefiro coniuga praticità e design in un unico prodotto. La testiera fissata a muro si propone in moduli di tre diverse lunghezze, 100 cm, 200 cm e 250 cm soddisfacendo tutte le misure di rete. All'estetica di Zefiro è possibile avvicinare qualsiasi tipo di letto sommier: con giroletto sospeso su piedini oppure a terra.

EN_

Zefiro combines design and practical features in one product. The wall-mounted headboard comes in modules in three different lengths: 100 cm, 200 cm and 250 cm, to fit all bed base sizes. The Zefiro look can be paired with any type of divan bed, with a frame suspended on feet or flat to the floor.



A Pannello imbottito _ Upholstered panel

C Mensola _ Shelf

B Pannello in legno _ Wooden panels

D Luce _ Light

IT_

I moduli delle testiere Zefiro si possono affiancare l'uno all'altro creando anche configurazioni molto ampie. Nella parte inferiore è possibile applicare una boiserie in legno con mensola/comodino. Lateralmente e nella parte superiore della testiera è anche possibile una retroilluminazione led molto gradevole.

EN_

The Zefiro headboard modules can be positioned side by side to create an extra wide composition. At the bottom, you can apply wood panelling to create a shelf/bedside table. At the top, you can add soft LED backlighting along the side.





IT_

Diana è una specchiera funzionale ad usi diversi nella casa. Con personalità integra più funzioni in un'estetica sobria, alcuni esempi: a servizio del letto come comodino laddove gli spazi sono contenuti o in ambienti adiacenti al lavabo o alla vasca diventando un porta salviette o porta prodotti da bagno con specchio a figura intera.

EN_

Diana is a practical mirror which you can put to different uses in the home. It has real personality and can play different roles as part of a sleek and simple design. For example, why not use it as a bedside table, where space by your bed is limited, or as a towel rack or product shelf next to a washbasin or bathtub with a full-length mirror.





IT_

L'armadio con anta Liscia può essere configurato con dei vani a giorno oppure con vani attrezzati per svolgere diverse funzioni. In questo caso abbiamo un vano portascarpe totalmente isolato dagli abiti. L'anta è completata da due pratici appendiabiti esterni.

EN_

The wardrobe with Liscia doors can be configured to include open compartments or other compartments designed for lots of different uses. Here the shoe rack has been made completely separate from the clothes rails. The look is finished with two practical clothes rails on view.

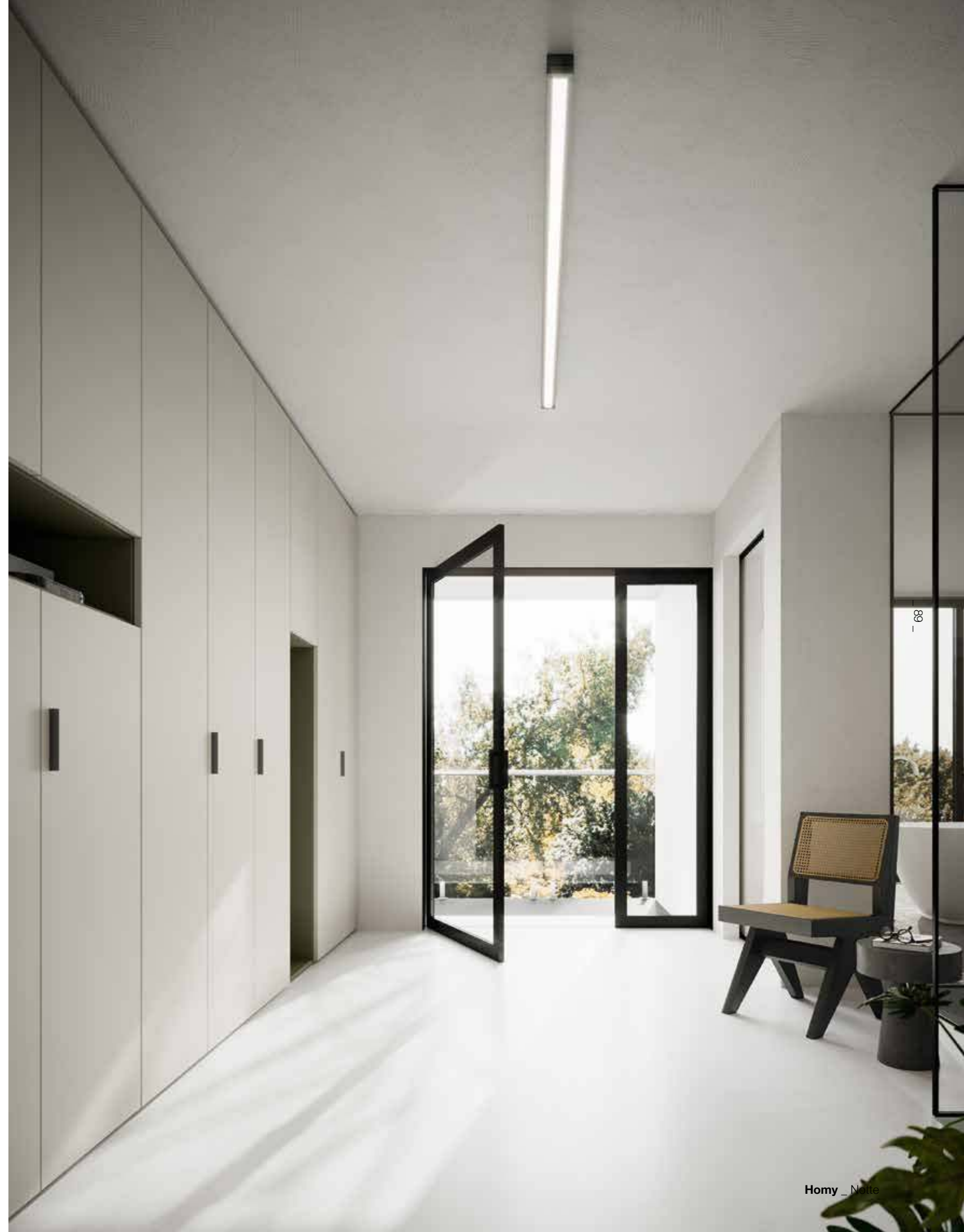

**MAPPA
STANZA**

Room plan

Location _ 001

Stanza _ **C**

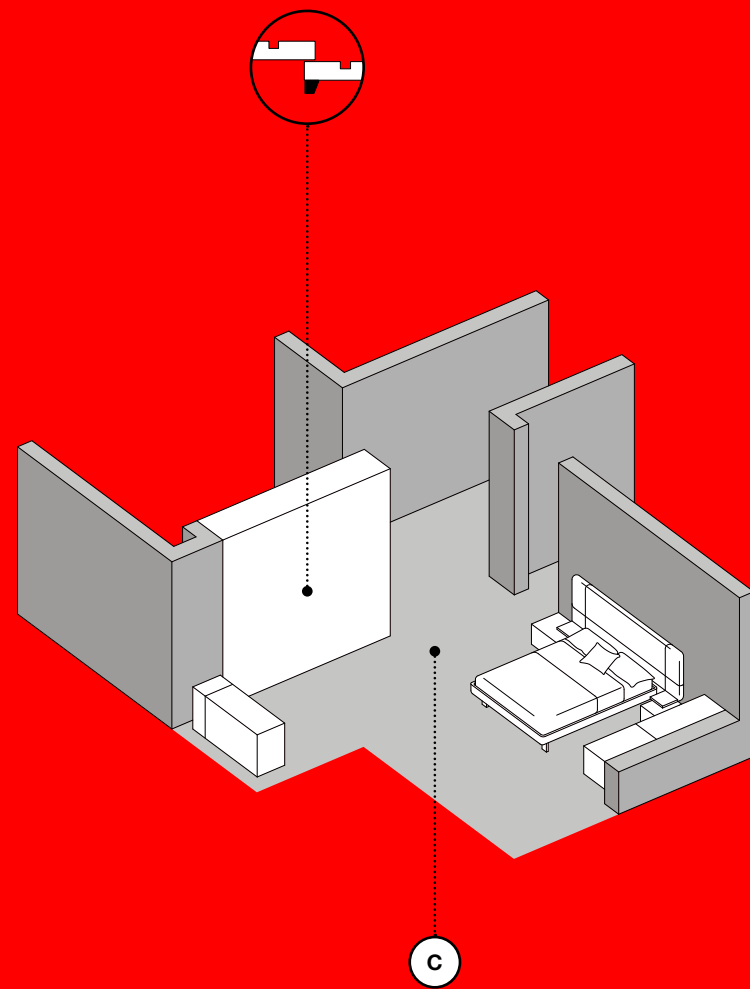

Letto _ ZEFIRO con tasche

Bed _ ZEFIRO with pockets

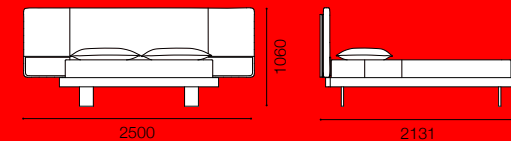

Testiera _ TX Roma 02
Headboard _ TX Roma 02

Ring _ CE Marna
Frame _ CE Marna

Armadio ante scorrevoli _ LISCIA

Sliding-door wardrobe _ LISCIA

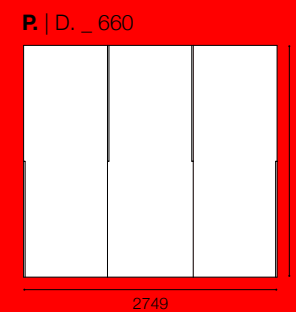

Scocca _ CE Bianco
Body _ CE Bianco

Anta _ TS Bianco
Door _ TS Bianco

Sistema componibile _ DICIOTTO

Modular range _ DICIOTTO

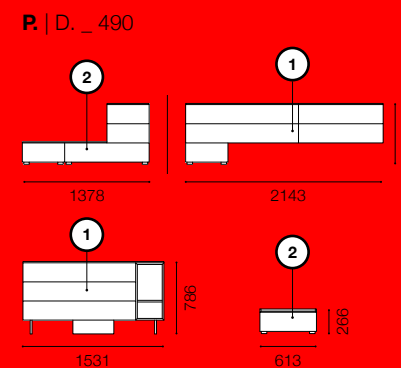

Scocca 1 _ CE Marna
Body 1 _ CE Marna

Frontale 1 _ CE Marna
Front 1 _ CE Marna

Scocca 2 _ LO Antimonio
Body 2 _ LO Antimonio

Frontale 2 _ LO Antimonio
Front 2 _ LO Antimonio

Vano a giorno _ CE Marna
Open compartment _ CE Marna

specchiera _ MEDUSA

Mirror _ MEDUSA

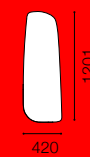

Specchio _ SS Argento
Mirror _ SS Argento

Struttura _ VM Black
Frame _ VM Black

Mood materico
Textured moods

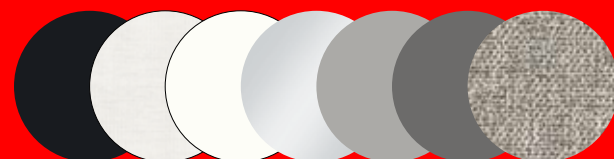

C Stanza C _ Letto ZEFIRO con tasche _ Armadio ante scorrevoli LISCIA _ Sistema Componibile DICIOTTO _ Specchiera MEDUSA
Room C _ ZEFIRO bed with pockets _ LISCIA sliding-door wardrobe _ DICIOTTO modular range _ MEDUSA mirror





IT_

La pratica tasca nella parte inferiore della testiera permette di riporre comodamente qualsiasi piccolo oggetto ci piaccia avere vicino prima di coricarsi, come ad esempio un libro o una rivista.

EN_

The practical pocket at the bottom of the headboard is perfect for storing any small items you want to keep beside your bed, like a book or magazine.



IT_

La finitura texturizzata Tissù decora l'armadio con sobrietà coniugando la trama tessile ed il rilievo materico effetto cemento; un decorativo geometrico volutamente "impreciso" che dà movimento e tridimensionalità alla superficie.

EN_

The textured Tissù finish subtly decorates the wardrobe, combining the textile finish and the cement-effect textured relief. This deliberately imperfect geometric motif adds movement and gives the surface a third dimension.



MAPPA STANZA

Room plan

Location _ 001

Stanza _ **D**

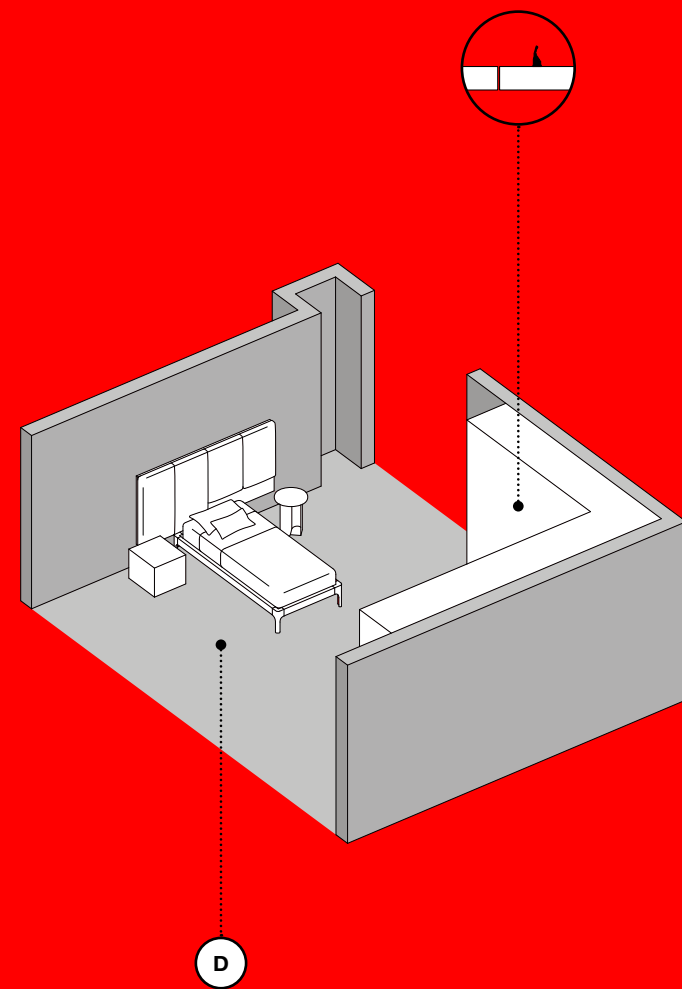

Letto _ ZEFIRO

Bed _ ZEFIRO

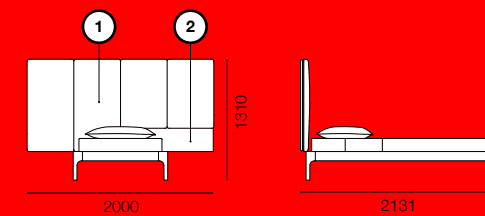

1 Testiera 1 _ TX Milano 19
Headboard 1 _ TX Milano 19

Ring _ CE Marna
Frame _ CE Marna

2 Testiera 2 _ ES Matwood Grey
Headboard 2 _ ES Matwood Grey

Armadio ante battenti _ LISCIA

Hinged-door wardrobe _ LISCIA

P. | D. _ 602

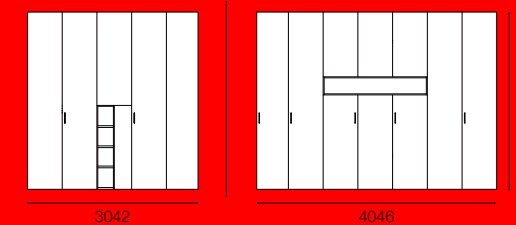

Scocca _ ES Matwood Grey
Body _ ES Matwood Grey

Anta _ CE Marna
Door _ CE Marna

Vani a giorno _ ES Matwood Grey
Open compartments _ ES Matwood Grey

Sistema Componibile _ DICIOTTO

Modular range _ DICIOTTO

P. | D. _ 490

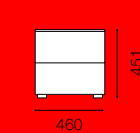

Scocca _ CE Marna
Body _ CE Marna

Frontale _ CE Marna
Front _ CE Marna

D Stanza D _ Letto ZEFIRO _ Armadio ante battenti LISCIA _ Sistema Componibile DICIOTTO _ Tavolino MIRÒ
Room D _ ZEFIRO bed _ LISCIA hinged-door wardrobe _ DICIOTTO modular range _ MIRÒ occasional table

Tavolino _ MIRÒ

Occasional table _ MIRÒ

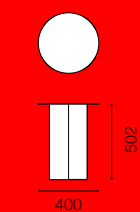

Struttura _ LO Nevada
Frame _ LO Nevada

Mood materico
Textured moods







IT_

La versatilità del sistema Zefiro permette di configurare anche soluzioni per la camera singola. La soluzione proposta esplicita la natura modulare e custom del modello: infatti qui si affiancano un modulo imbottito a uno dotato di boiserie in legno. Il tavolino in lamiera Mirò a taglio laser, un elemento trasversale dotato di un vano di contenimento nel fusto. È disponibile in tutti i colori laccati di Santalucia Mobili.

EN_

Zefiro is so versatile you can also use it to create compositions in single bedrooms. This solution shows just how modular and easy to customise this piece is. Here, an upholstered module is used alongside wooden panelling. The laser-cut Mirò occasional table made from sheet metal is really versatile and has a storage compartment built into the frame. It is available in all Santalucia Mobili lacquered colours.





Dimensioni: L.3893 H.2530 P.602
 Size: W.3893 H.2530 D.602

Scocca e Frontale _ CE Limo
 Body and Front _ CE Limo

Vano a Giorno _ LO Cuoio
 Open Compartment _ LO Cuoio



Scocca e Frontale _ CE Limo
 Body and Front _ CE Limo

Vano a Giorno _ LO Basalto
 Open Compartment _ LO Basalto



Scocca e Frontale _ CE Limo
 Body and Front _ CE Limo

Vano a Giorno _ LO Nevada
 Open Compartment _ LO Nevada



IT_

Alcuni esempi di configurazione per l'armadio con anta Liscia. Vani a giorno verticali e orizzontali. Vani accessorati. Soluzioni ibride funzionali a rompere la monotonia dei grandi armadi offrendo nuovi utilizzi derivati dalla vita contemporanea che negli spazi domestici cerca sempre più arredi fluidi e soluzioni salva-spazio.

EN_

Here are some examples of how to configure the wardrobe with Liscia doors: with horizontal and vertical open compartments and accessorised compartments. These practical, hybrid solutions break up the monotony of large wardrobe fronts. They offer new uses derived from modern living, which seeks more fluid furnishings and space-saving solutions for the home.

**MAPPA
STANZA**

Room plan

Location _ 002

Stanza _ E

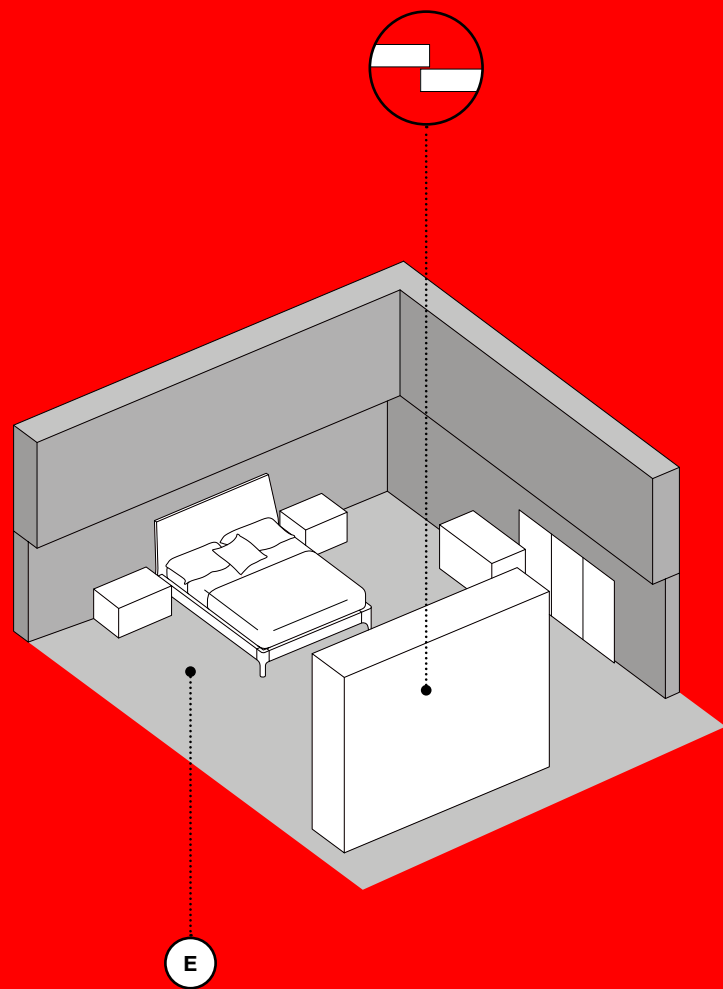

E

E Stanza E _ Letto LEVANTE _ Armadio ante scorrevoli PIANA _ Sistema Componibile DICIOTTO
Room E _ LEVANTE bed _ PIANA sliding-door wardrobe _ DICIOTTO modular range

Mood materico
Textured moods



Letto _ LEVANTE

Bed _ LEVANTE

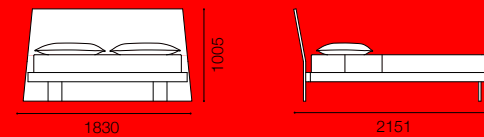

Testiera _ CE Bianco
Headboard _ CE Bianco

Ring _ CE Bianco
Frame _ CE Bianco

Armadio ante scorrevoli _ PIANA

Sliding-door wardrobe _ PIANA

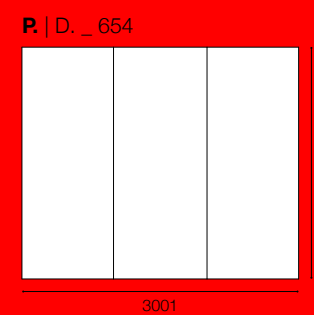

Scocca _ LO Antimonio
Body _ LO Antimonio

Anta _ LO Antimonio
Door _ LO Antimonio

Sistema Componibile _ DICIOTTO

Modular range _ DICIOTTO

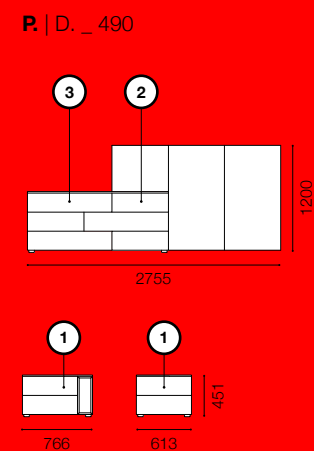

1 Scocca 1 _ ES Matwood Grey
Body 1 _ ES Matwood Grey

1 Frontale 1 _ ES Matwood Grey
Front 1 _ ES Matwood Grey

2 Scocca 2 _ CE Marna
Body 2 _ CE Marna

2 Frontale 2 _ CE Marna
Front 2 _ CE Marna

3 Frontale 3 _ MT Marna
Front 3 _ MT Marna

Boiserie _ ES Matwood Grey
Wood panelling _ ES Matwood Grey



_ 108 _

_ 109 _



IT_

Gli armadi sono attrezzati internamente con accessori e soluzioni contenitive che aiutano ad organizzare lo spazio in maniera funzionale valorizzando allo stesso tempo anche l'aspetto estetico.

EN_

The wardrobes are fitted with internal accessories and storage solutions to help you organise the space in a practical way, while also creating a great look.



IT_

Il sistema Diciotto si presta ad essere configurato con pannelli a boiserie funzionali ad essere accessoriati liberamente con mensole o appendiabiti anche in spazi non necessariamente residenziali. Diventano elementi decorativi di coordinamento ad altri elementi della camera dal momento che sono disponibili in tutte le finiture a catalogo.

EN_

The Diciotto range lends itself to being configured with practical wooden panelling and accessorised with shelves and clothes rails, even beyond the domestic space. The units can be used as decorative pieces to coordinate with other elements in the room, as they are available in all the finishes in the catalogue.

**MAPPA
STANZA**

Room plan

Location _ 003

Stanza _ **F**

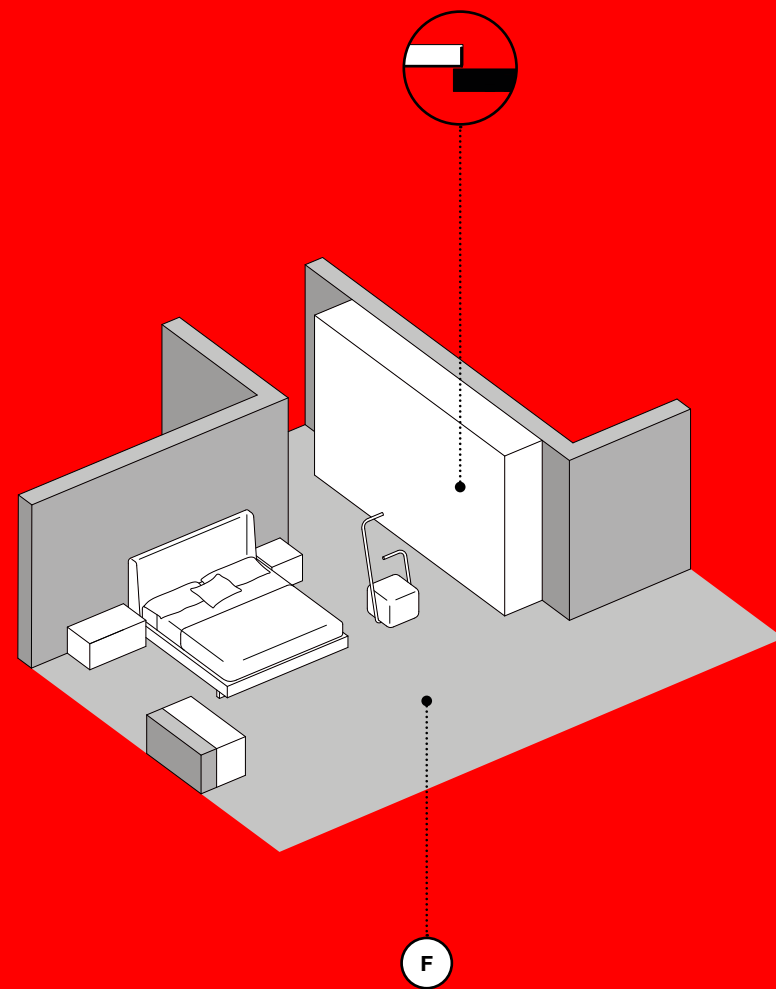

Letto _ LIBECCIO

Bed _ LIBECCIO

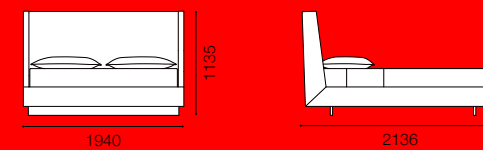

Testiera _ TX Milano 24
Headboard _ TX Milano 24

Ring _ ES Matwood Dark
Frame _ ES Matwood Dark

Armadio ante scorrevoli _ MASTER

Sliding-door wardrobe _ MASTER

P | D. _ 654

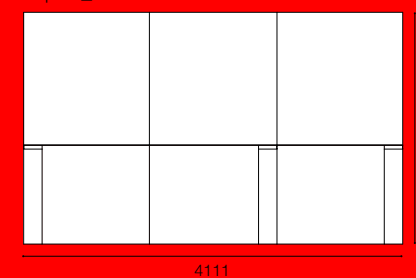

Scocca _ CE Pepe
Body _ CE Pepe

Anta _ CE Pepe
Door _ CE Pepe

Maniglia _ VM Nickel
Handle _ VM Nickel

Sistema Componibile _ DICIOTTO

Modular range _ DICIOTTO

P | D. _ 490

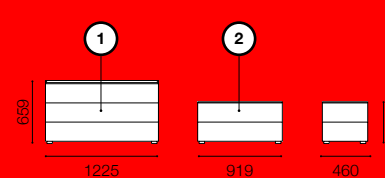

1
Scocca 1 _ ES Matwood Dark
Body 1_ ES Matwood Dark

1
Frontale 1 _ ES Matwood Dark
Front 1_ ES Matwood Dark

2
Scocca 2 _ LO Muggese
Body 2 _ LO Muggese

2
Frontale 2 _ MT Muggese
Front 2 _ MT Muggese

F Stanza F _ Letto LIBECCIO _ Armadio ante scorrevoli MASTER _ Sistema Componibile DICIOTTO _ Appendiabiti MATISSE
Room F _ LIBECCIO bed _ MASTER sliding-door wardrobe _ DICIOTTO modular range _ MATISSE clothes hanger

Mood materico
Textured moods



Appendiabiti _ MATISSE

Clothes hanger _ MATISSE

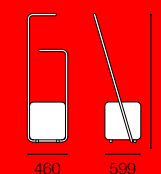

Pouff _ TX Milano 24
Footstool _ TX Milano 24

Struttura _ VM Black
Frame _ VM Black



- 116 -



- 117 -



Dimensioni: L.1940 H.1142 P.2186

Size: W.1940 H.1142 D.2186



Ring e Testiera_TX Genova 619
Frame and Headboard_TX Genova 619



Piede_VM Black
Foot_VM Black



— 120 —

— 121 —



Maniglia _ VM Titanio
Handle _ VM Titanio



- 124 -

Dimensioni: L.3250 H.2530 P.602
Size: W.3250 H.2530 D.602

Scocca e Anta_ ES Matwood Grey
Body and Door_ ES Matwood Grey

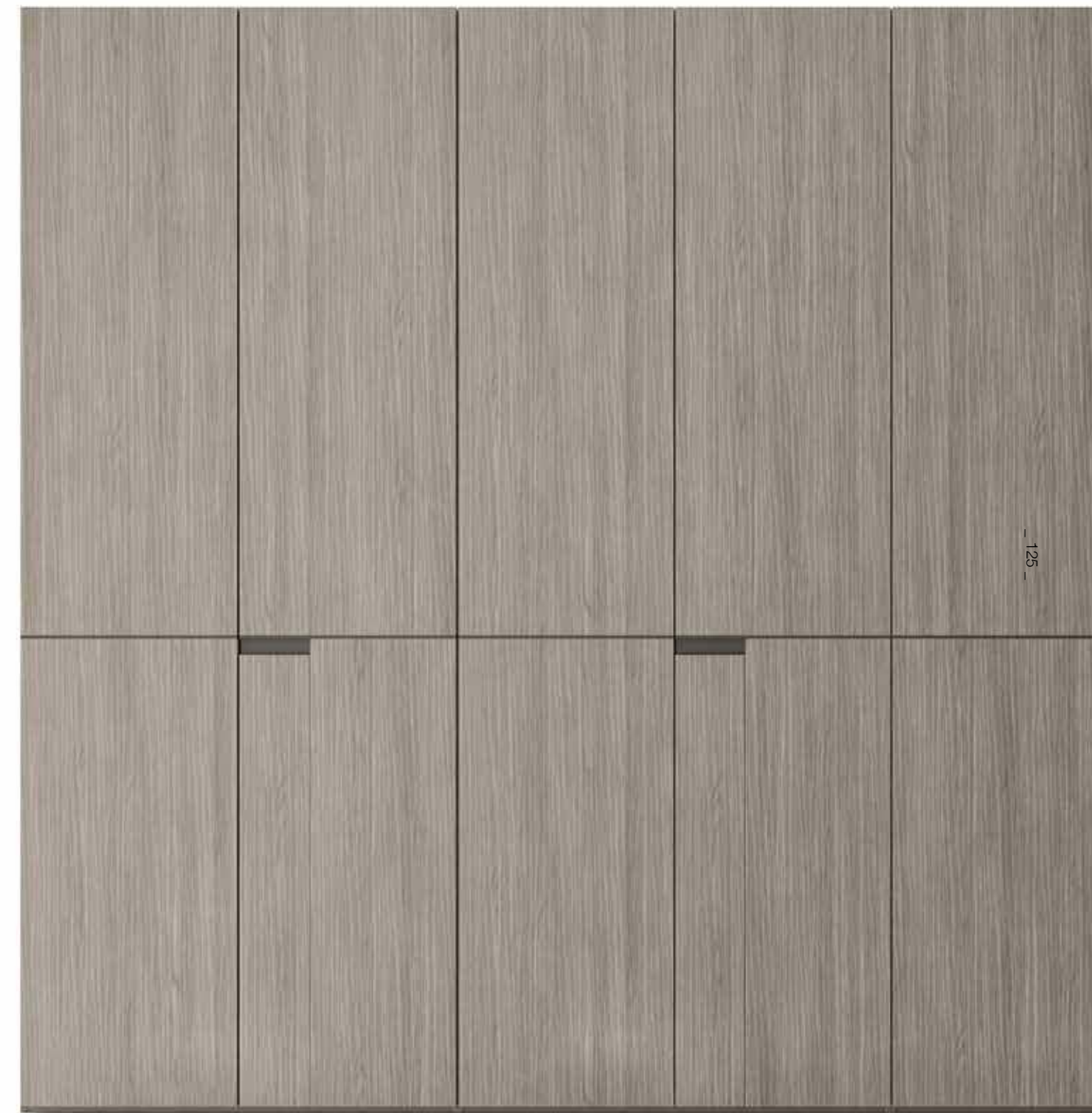

- 125 -

Dimensioni: L.3250 H.2530 P.602
Size: W.3250 H.2530 D.602

 **Scocca _ ES Matwood Coffee**
Body _ ES Matwood Coffee

 **Anta _ LO Maggese**
Door _ LO Maggese

 **Maniglia _ VM Titanio**
Handle _ VM Titanio





IT_

Gli elementi del Sistema Diciotto danno la possibilità di avere un top completo di fianchi e schiena di contenimento. Una soluzione a vassoio aperto esteticamente pregevole ed anche molto funzionale al contenimento temporaneo e disinvolto di oggetti o indumenti quotidiani.

EN_

The units in the Diciotto range allow you to create a top complete with sides and a back panel for storage. The open tray solution adds the perfect aesthetic touch that is also really practical as somewhere to put down everyday items or clothing.



IT_

Il pouf appendiabiti Matisse è un oggetto funzionale ad essere utilizzato in diversi spazi della casa, dalla camera alle aree disimpegno o ingresso. Un tubo metallico abbraccia la seduta imbottita elevandosi con due segmenti utili ad appendere o appoggiare gli abiti diventando così una sorta di angolo spogliatoio completo.

EN_

The Matisse footstool with clothes hanger is a functional piece which can be used in different spaces, from the bedroom to the hallway or entrance. The metal bar wraps around the upholstered seat and extends upwards along two tracks, useful for hanging or resting clothes on, and creating a sort of dressing room corner.

MAPPA STANZA

Room plan

Location _ 004

Stanza _ G

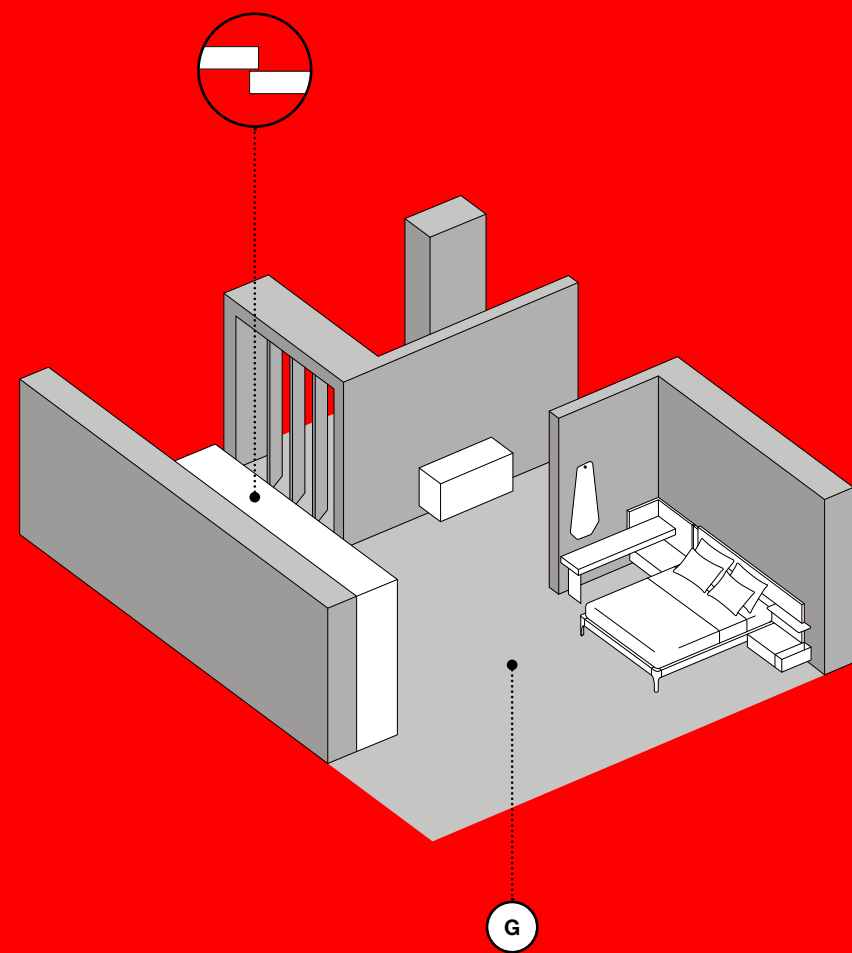

Letto _ SCACCO

Bed _ SCACCO

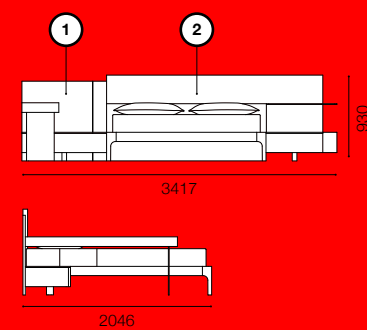

- 1** Testiera 1 _ LO Ecrù
Headboard 1 _ LO Ecrù
- 2** Testiera 2 _ TX Genova 200
Headboard 2 _ TX Genova 200
- Ring _ ES Matwood Dark
Frame _ ES Matwood Dark
- Consolle _ LM Navajo Gold + VV Stopsol
Console table _ LM Navajo Gold + VV Stopsol

Armadio ante scorrevoli _ FASCIA

Sliding-door wardrobe _ FASCIA

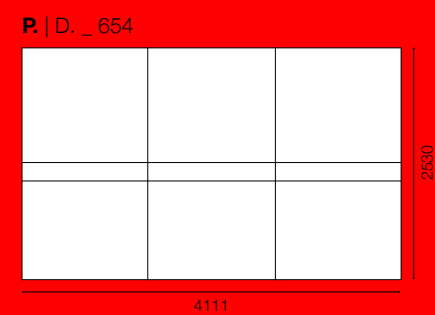

- Scocca _ CE Limo
Body _ CE Limo
- Anta _ CE Limo
Door _ CE Limo
- Fascia _ ES Matwood Dark
Insert _ ES Matwood Dark

Sistema Componibile _ DICIOTTO

Modular range _ DICIOTTO

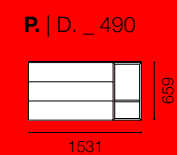

- Scocca e Frontali _ CE Limo
Body and fronts _ CE Limo
- Scocca 2 _ CE Limo
Body 2 _ CE Limo

G Stanza G _ Letto SCACCO _ Armadio ante scorrevoli FASCIA _ Sistema Componibile DICIOTTO _ Specchiera AFRODITE
Room G _ SCACCO bed _ FASCIA sliding-door wardrobe _ DICIOTTO modular range _ AFRODITE mirror

Specchiera _ AFRODITE

Mirror _ AFRODITE

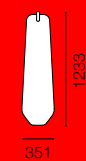

- Specchio _ SS Argento
Mirror _ SS Argento

Mood materico
Textured moods







IT_

Il sistema Scacco offre una quantità di soluzioni estetiche e funzionali senza precedenti. Elementi diversi per forme e funzioni, ma uguali per i materiali: tra questi la mensola, il vano portariviste e la gamba della consolle. Il piano consolle trucco invece è disponibile in diverse finiture.

EN_

Scacco offers an unprecedented number of aesthetic and functional solutions. The units come in different shapes and have different purposes, but use the same materials. They include a shelf, magazine compartment and the console table leg. The vanity console top is available in different finishes.



Dimensioni: L.3417 H.1017 P.2046
 Size: W.3417 H.1017 D.2046

Ring e Testiera _ ES Matwood Dark
 Frame and Headboard _ ES Matwood Dark

Contenitore e Mensola _ VV Stopsol
 Storage Unit and Shelf _ VV Stopsol

Testiera _ TX Roma 45
 Headboard _ TX Roma 45

Mensola _ VM Black
 Shelf _ VM Black

A Mensola_Shelf

B Luce_Light

C Mensolina in vetro_Small glass shelf

D Contenitore in vetro_Glass storage unit



- 138 -

- 139 -

IT_

Il letto Scacco è un sistema autoportante e altamente configurabile di cui i numerosi accessori e le varianti materiche rappresentano il vero potenziale. La testiera può essere dotata di illuminazione led verticale sulla pannellatura o sotto la mensola in vetro. Il vano in metallo applicabile sulla pannellatura della testiera è disponibile in tutti i colori laccati.

EN_

The Scacco bed is a self-supporting, highly configurable structure and has real potential thanks to numerous accessories and texture variations. The headboard can be lit with a vertical LED strip either along the panelling or under the glass shelf. The metal compartment on the headboard panelling is available in all standard lacquered colours.



Dimensioni: L.2957 H.930 P.2046
 Size: W.2957 H.930 D.2046

Ring e Testiera _ ES Matwood Grey
 Frame and Headboard_ ES Matwood Grey

Mensola _ VV Stopsol
 Shelf _ VV Stopsol

Testiera _ EX Napoli 02
 Headboard _ EX Napoli 02

Dimensioni: L.2957 H.1240 P.2046
 Size: W.2957 H.1240 D.2046

- 140 -



- 141 -



IT_

Oltre ai numerosi accessori la testiera Scacco offre la possibilità di evolversi in altezza sovrapponendo un secondo modulo imbottito o pannello rigido.

EN_

In addition to the numerous accessories, the height of the Scacco headboard can also be customised by a second stacking upholstered module or hard panel.



MAPPA STANZA

Room plan

Location _ 005

Stanza _ H

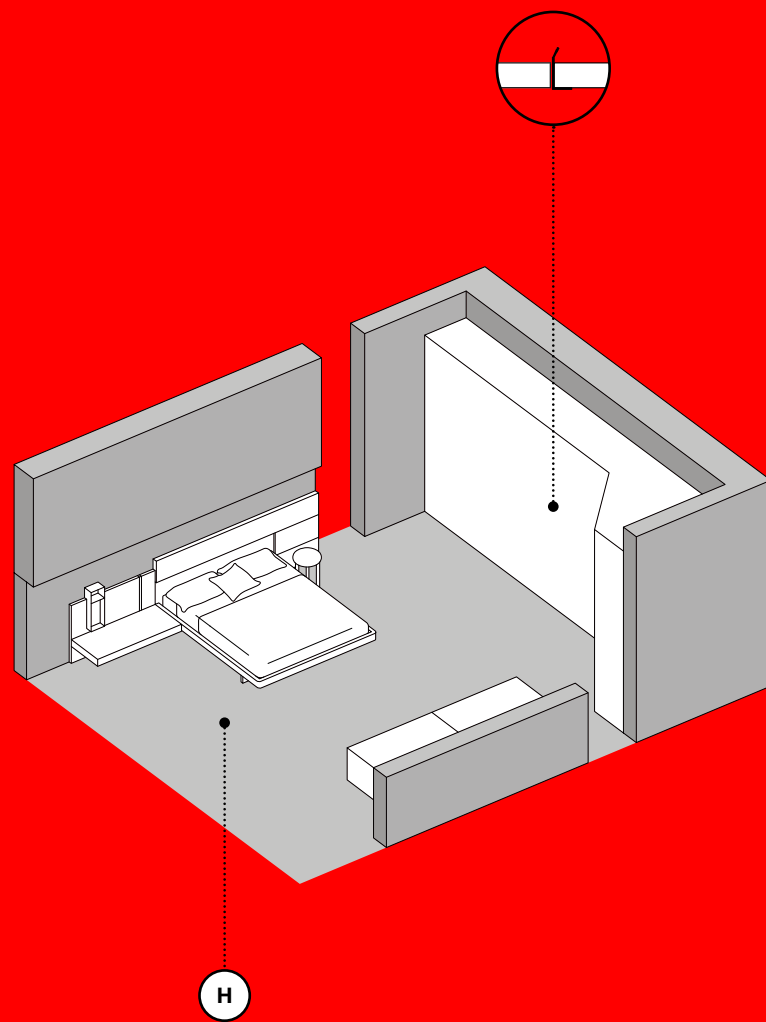

— 144 —

— 145 —

H

Stanza H _ Letto SCACCO _ Armadio ante battenti FASCIA _ Sistema Componibile DICHIOTTO _ Tavolino GIOTTO
Room H _ SCACCO bed _ FASCIA hinged-door wardrobe _ DICHIOTTO modular range _ GIOTTO occasional table

Mood materico
Textured moods



Letto _ SCACCO

Bed _ SCACCO

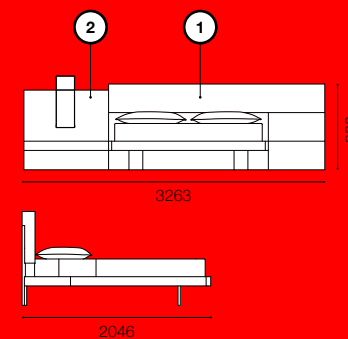

1 **Testiera 1 _ IM Legno Tundra**
Headboard 1 _ IM Legno Tundra

Ring _ LO Ghiaccia
Frame _ LO Ghiaccia

2 **Testiera 2 _ LO Ghiaccia**
Headboard 2 _ LO Ghiaccia

Accessori _ VM Black
Accessories _ VM Black

Armadio ante battenti _ FASCIA

Hinged-door wardrobe _ FASCIA

P. | D. _ 602 / 1603

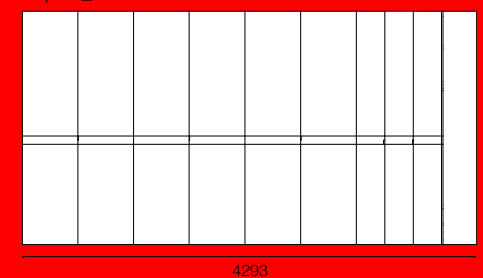

Scocca _ LO Ghiaccia
Body _ LO Ghiaccia

Anta _ LO Ghiaccia
Door _ LO Ghiaccia

Fascia _ IM Legno Tundra
Insert _ IM Legno Tundra

Sistema componibile _ DICHIOTTO

Modular range _ DICHIOTTO

P. | D. _ 490

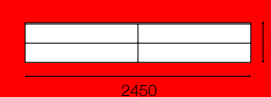

Scocca _ LO Ghiaccia
Body _ LO Ghiaccia

Frontale _ IM Legno Tundra
Front _ IM Legno Tundra

Tavolino _ GIOTTO

Occasional table _ GIOTTO



Struttura _ LO Verde Ombra
Frame _ LO Verde Ombra





- 146 -

- 147 -





IT_

L'elemento spogliatoio è un modulo per le armadiature che si sviluppa ad angolo. L'apertura può essere a due o tre ante, nella versione più grande presenta su un lato un fianco terminale mentre nella versione più piccola può svilupparsi con l'aggiunta di altri moduli da ambedue le parti.

EN_

The dressing room unit is a corner module for your wardrobe. It can have two or three doors. For the larger version, there is an end panel on one side, while the smaller version can be extended with additional modules on either side.

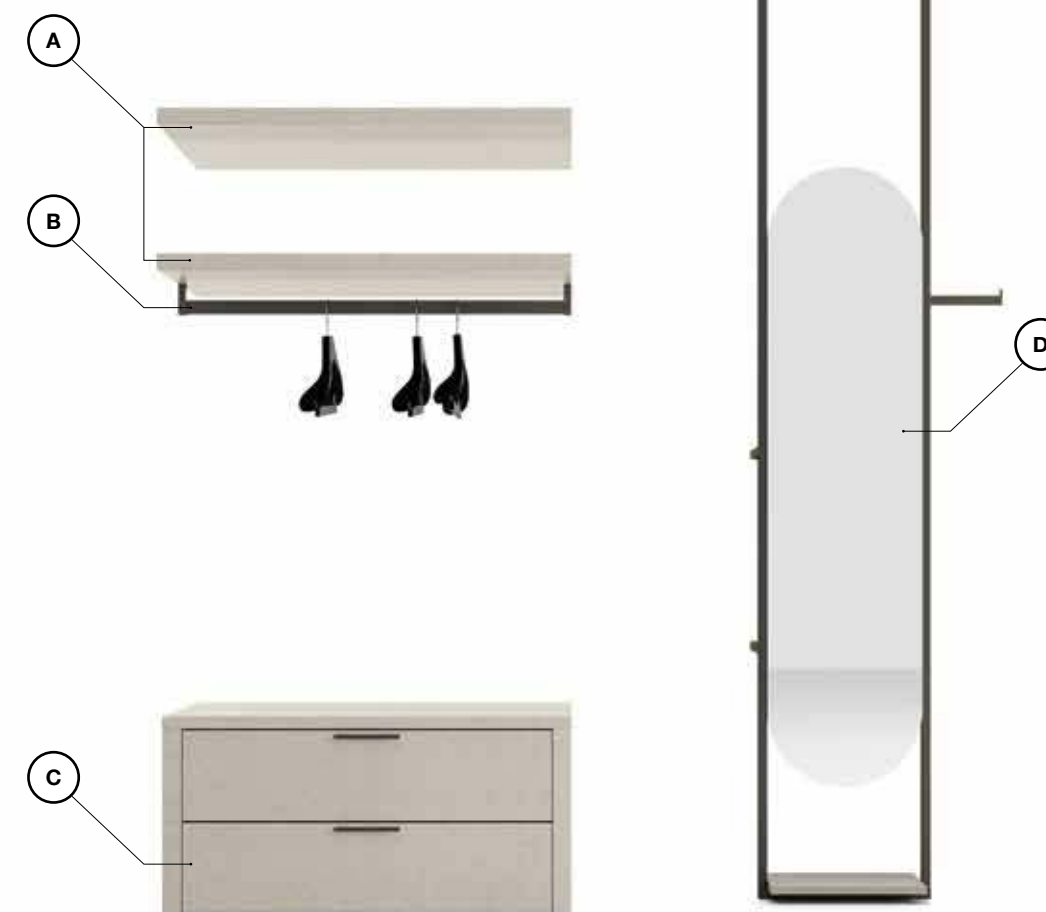

IT_

Lo spazio interno dell'angolo spogliatoio può essere attrezzato con un gran numero di elementi: infatti, oltre a gran parte dell'attrezzatura interna di serie, sono stati pensati e progettati alcuni articoli dedicati. Dalla panca alla specchiera sospesa con mensole, dal raster alla specchiera sulla schiena.

A Mensole_Shelves

B Appendiabiti_Hangers

EN_

The space inside the dressing unit can be kitted out with a number of fittings. In addition to most of the standard internal wardrobe fittings, there is also a selection of specially designed accessories. These include a bench, a floating mirror with shelves, cubby holes and a mirror on the back panel.

C Cassettiera_Drawer unit

D Specchiera_Mirror

MAPPA STANZA

Room plan

Location _ 006

Stanza _ I

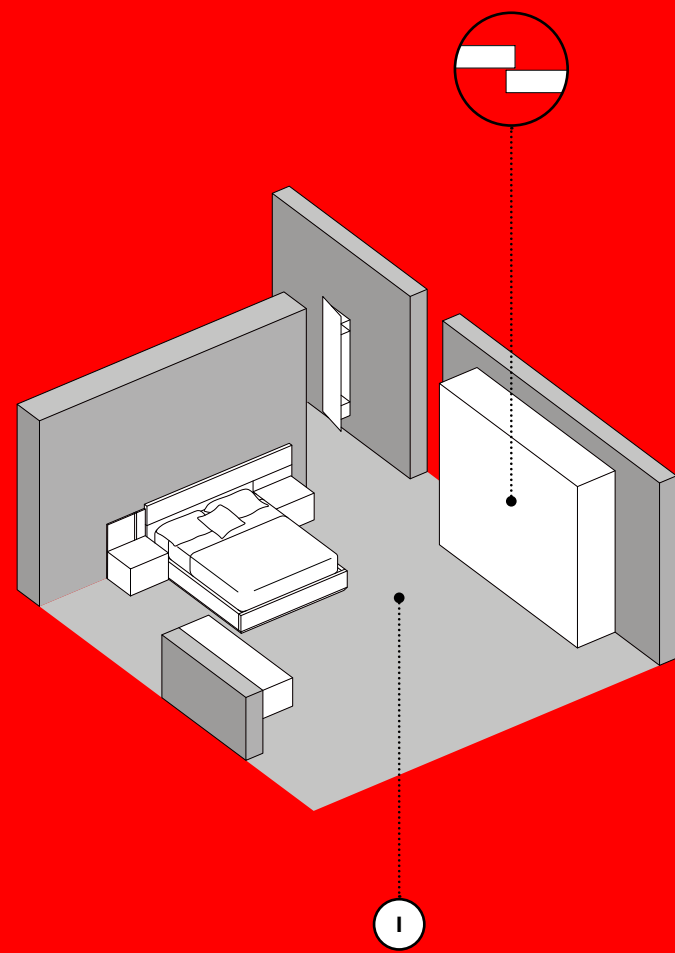

Letto _ SCACCO

Bed _ SCACCO

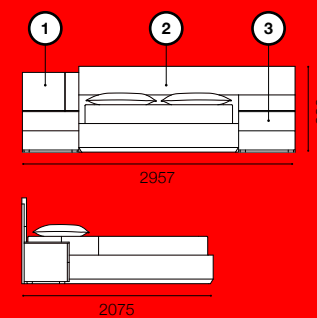

- 1** Testiera 1 _ EH Matwood Honey
Headboard 1 _ EH Matwood Honey
- 2** Testiera 2 _ CE Limo
Headboard 2 _ CE Limo
- 3** Scocca 3 _ EH Matwood Honey
Body 1_ EH Matwood Honey
- Ring _ EH Matwood Honey**
Frame _ EH Matwood Honey
- Frontale 3 _ EH Matwood Honey**
Front 1_ EH Matwood Honey

Armadio ante scorrevoli _ FASCIA

Sliding-door wardrobe _ FASCIA

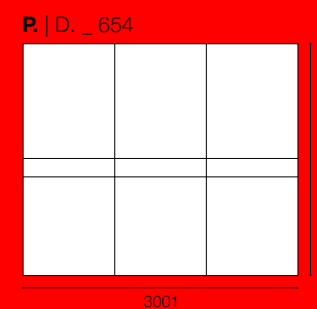

- Scocca _ CE Limo**
Body _ CE Limo
- Anta _ CE Limo**
Door _ CE Limo
- Fascia _ TR Tela**
Insert _ TR Tela

Sistema Componibile _ DICIOTTO

Modular range _ DICIOTTO

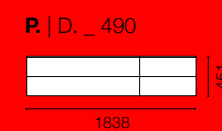

- Scocca _ CE Limo**
Body _ CE Limo
- Frontale _ TR Tela**
Front _ TR Tela

1 Stanza I _ Letto SCACCO _ Armadio ante scorrevoli FASCIA _ Sistema Componibile DICIOTTO _ Specchiera ATENA
Room I _ SCACCO bed _ FASCIA sliding-door wardrobe _ DICIOTTO modular range _ ATENA mirror

Specchiera _ ATENA

Mirror _ ATENA

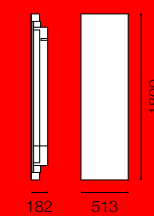

- Specchio _ SS Argento**
Mirror _ SS Argento
- Struttura _ VM Black**
Frame _ VM Black

Mood materico
Textured moods







- 158 -

IT_

La finitura caratterizzante Trama Tela si può applicare ai frontali del Sistema Diciotto e sull' inserto dell'armadio Fascia. La trasversalità di questa finitura permette di coordinare vari elementi della camera con un decoro sobrio ed elegante.

EN_

The characteristic Tela texture can be applied to the fronts of the Diciotto range and on the insert on the Fascia wardrobe. The flexible, versatile nature of this finish means you can coordinate different units in your bedroom to create a no-frills, elegant look.

- 159 -

- 160 -



- 161 -



IT_

La specchiera Atena è uno specchio completato da un vano contenitore con annesso appendiabiti. È l'inclinazione dello specchio che permette l'alloggio di un vano funzionale e contenuto. Si sviluppa in verticale in un'altezza a figura intera. Per la sua natura trasversale trova facile collocazione in molti ambienti della casa, oltre che naturalmente, nella camera da letto.

EN_

The Atena mirror comes complete with a storage unit and clothes rail. Thanks to the angle of the mirror, there is room for a practical, compact compartment behind. The mirror extends vertically and is full length. Thanks to its versatility, it looks at home in many corners of the house, as well as in the bedroom of course.

A Specchiera_Mirror

B Appendiabiti_Hangers

MAPPA STANZA

Room plan

Location _ 007

Stanza _ J

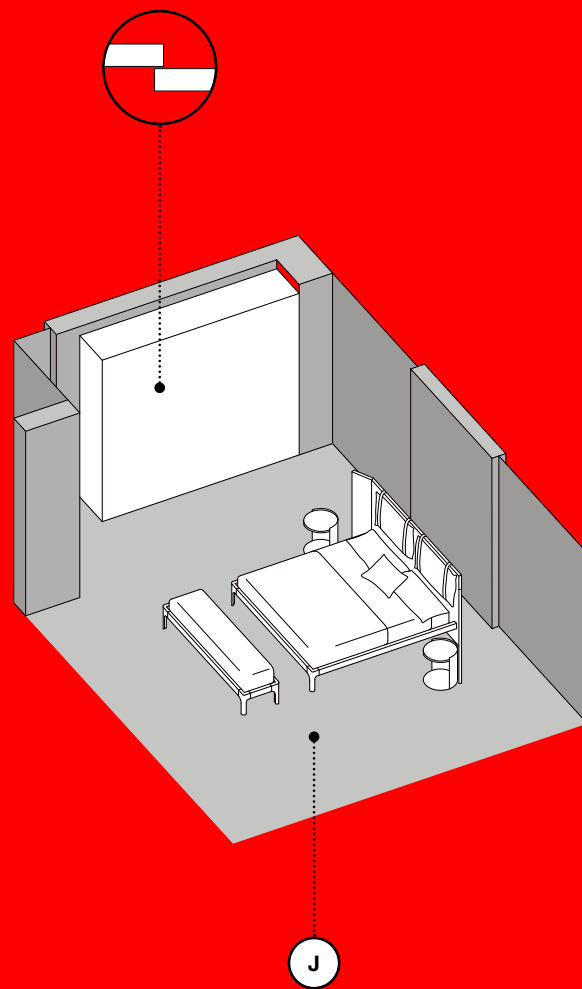

Letto _ MAISTRO

Bed _ MAISTRO

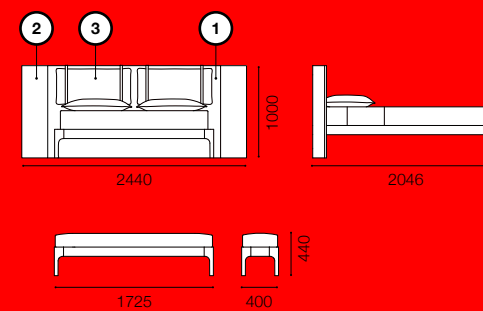

- 1 **Testiera 1 _ ES Matwood Dark**
Headboard 1 _ ES Matwood Dark
- 2 **Testiera 2 _ SL Limo**
Headboard 2 _ SL Limo
- 3 **Testiera 3 e Panca _ TX Venezia 20**
Headboard 3 and Bench _ TX Venezia 20
- Ring _ ES Matwood Dark**
Frame _ ES Matwood Dark

Armadio ante scorrevoli _ FASCIA

Sliding-door wardrobe _ FASCIA

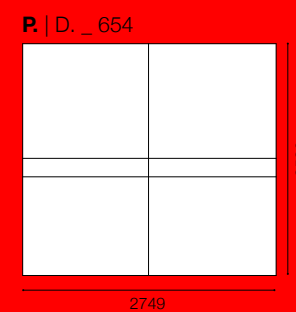

- Scocca _ CE Limo**
Body _ CE Limo
- Anta _ CE Limo**
Door _ CE Limo
- Fascia _ SL Limo**
Insert _ SL Limo

Tavolino _ MICHELANGELO

Occasional table _ MICHELANGELO

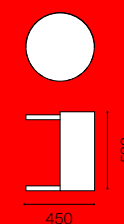

- Struttura _ VM Black**
Frame _ VM Black
- Piano _ LM Travertino**
Top _ LM Travertino

J Stanza J _ Letto MAISTRO _ Armadio ante scorrevoli FASCIA _ Tavolino MICHELANGELO
Room J _ MAISTRO bed _ FASCIA sliding-door wardrobe _ MICHELANGELO occasional table

Mood materico
Textured moods





Dimensioni: L.2440 H.1000 P.2046

Size: W.2440 H.1000 D.2046



Testiera e Ring _ ES Matwood Dark
Frame and Headboard _ ES Matwood dark



Testiera e Ring _ TX Bari 80
Frame and Headboard _ TX Bari 80

Dimensioni: L.450 H.1260 P.450

Size: W.450 H.1260 D.450



Piano _ LM Botticino
Top _ LM Botticino



Struttura _ VM Black
Frame _ VM Black



- 168 -

- 169 -

IT_

Il letto Maestro precedentemente caratterizzato dalla finitura Scult presente nei pannelli laterali, in questa soluzione propone il rivestimento tessile su longoni e pediera lasciando scoperta e visibile la gamba. Analogamente le due ali laterali alla testiera, che possono essere fissate con un angolo minimo preimpostato oppure in linea alla testiera, sono rivestite con il medesimo tessuto. A lato il comodino Leonardo a base tonda: un innovativo sistema comodino/servetto, funzionale ad appoggiarci indumenti in utilizzo quotidiano.

EN_

The Maestro bed previously featured the Scult finish on the side panels but here offers textured upholstery on the long side panels and footboard, leaving the legs bare. Similarly, the two side wings attached to the headboard are upholstered in the same fabric. They can be fixed at a pre-set minimum angle or assembled in line with the headboard. Next to the bed is the Leonardo table with a round base: an innovative bedside table-come-rail that is handy for hanging up the clothes you use every day.

Dimensioni: L.1838 H.1843 P.490

Size: W.1838 H.1843 D.490

 **Boiserie _ ES Matwood Dark**
Wood Panelling _ ES Matwood Dark

 **Frontale _ SL Ecrù**
Front _ SL Ecrù

 **Specchio _ SS Argento**
Mirror _ SS Argento

 **Scocca _ LO Ecrù**
Body _ LO Ecrù



- 170 -

IT_

La finitura Scult può essere usata anche nei frontali del Sistema Diciotto e nella fascia orizzontale dell'armadio con anta Fascia. Scult è una finitura decorativa tridimensionale caratterizzata dalla scanalatura inversa.

EN_

The Scult finish can also be used on the fronts of the units in the Diciotto range, and on the horizontal insert across the Fascia wardrobe doors. Scult is a 3D decorative finish featuring an inverse groove.



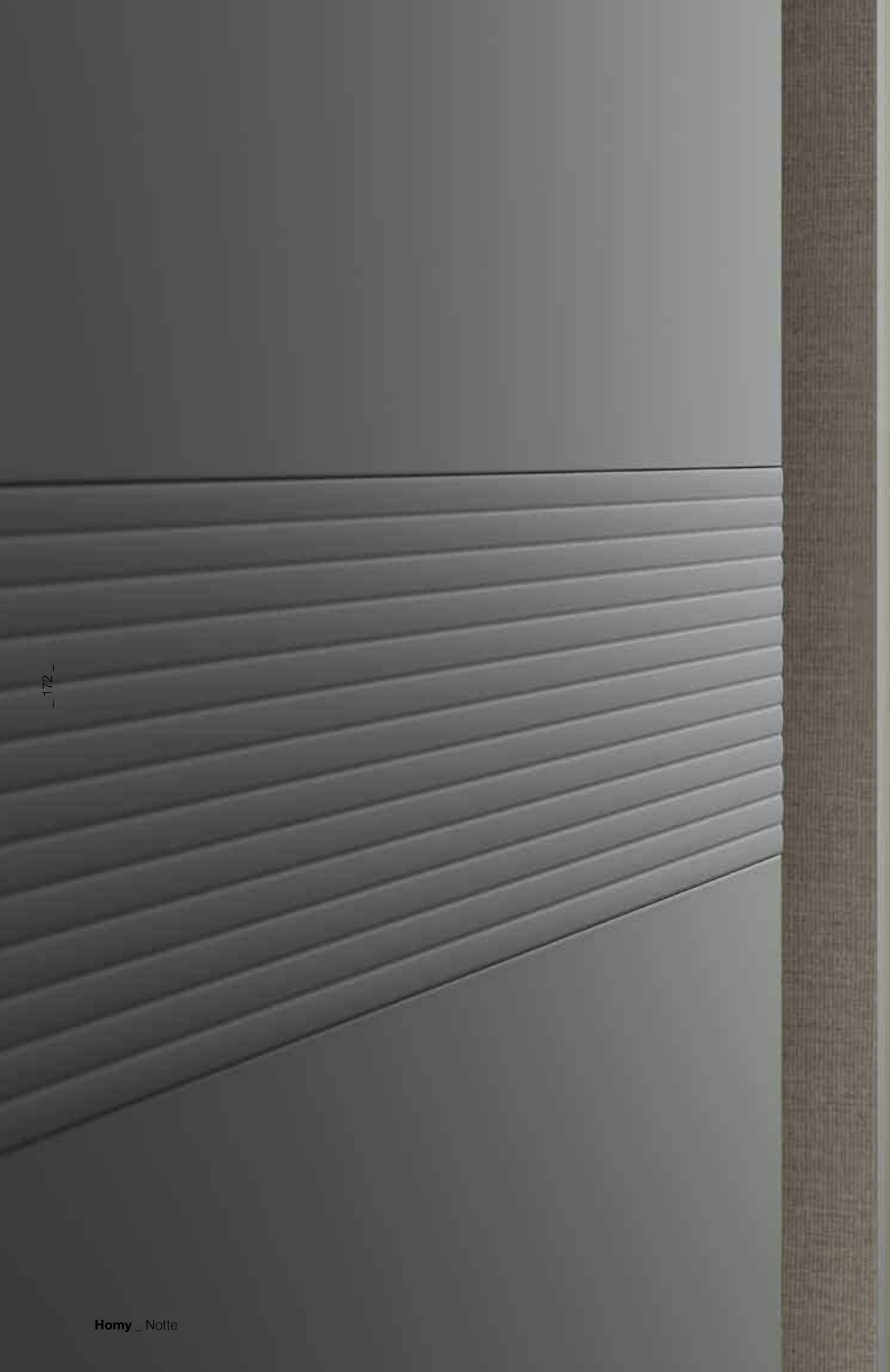

- 172 -

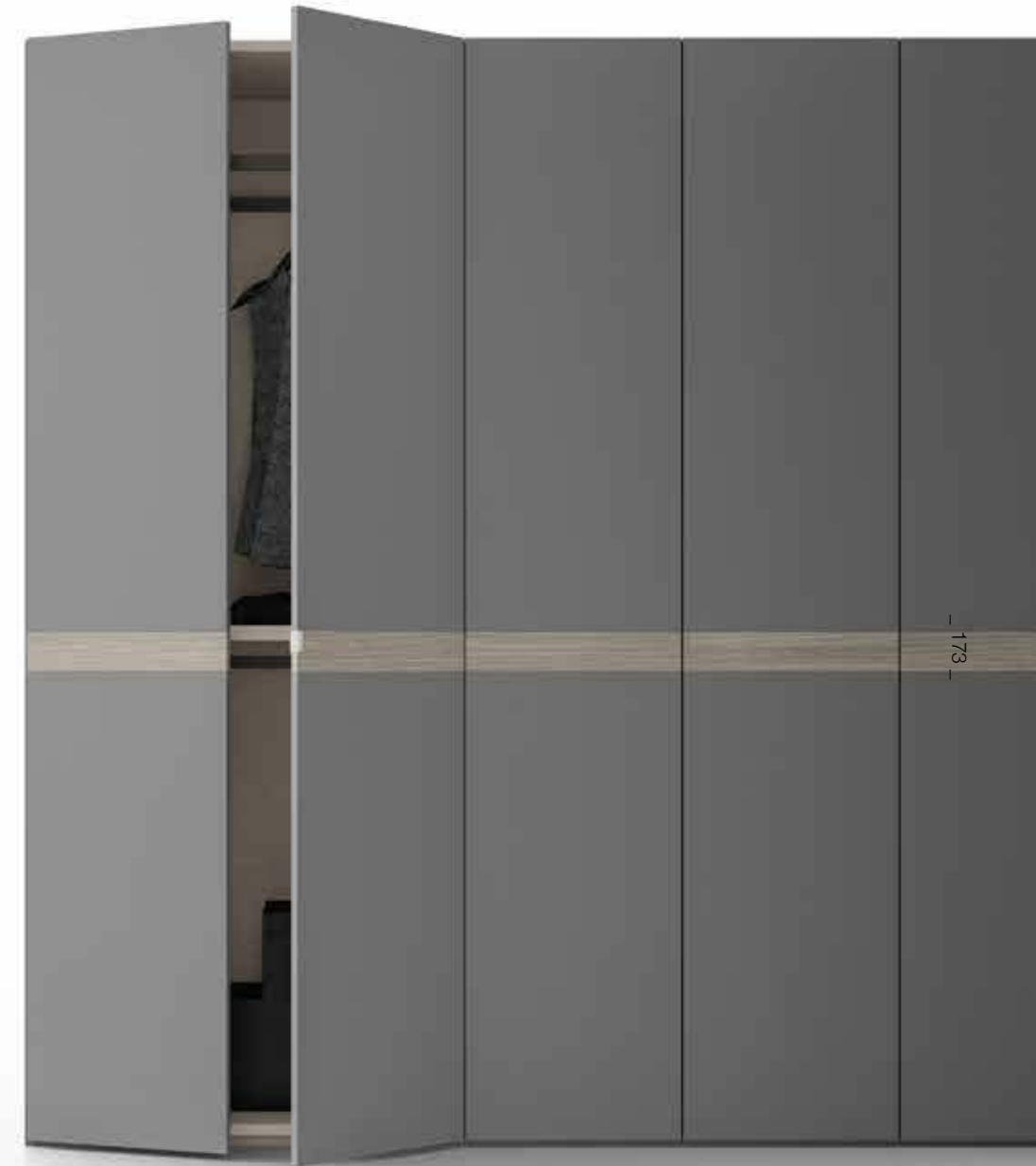

- 173 -

IT_

I modelli di anta Fascia sia battente che scorrevole si distinguono per il segmento decorativo orizzontale che spezza le ante. La maggior parte di questi decorativi è trasversale tra le due ante e si coordina con gli altri elementi della camera, in particolare con i frontali dei Sistemi Diciotto ed Ego.

EN_

The Fascia door in both the hinged and sliding models features a decorative horizontal insert that breaks up the fronts. Most of these decorative details cross both doors and coordinate with other elements in the room, especially with the door fronts in the Diciotto and Ego ranges.



Colori ECO_ ECO colours



Eco Bianco

Eco Limo

Eco Pepe

Eco Marna

Essenze_ Wood Grains



Matwood White

Mtawood Grey

Matwood Coffee

Matwood Dark

Scult Essenze_ Scult wood grains



Scult Matwood White

Scult Matwood Grey

Scult Matwood Coffee

Scult Matwood Dark

Impiallaciati_ Veneers



Legno Steppa

Legno Tundra

Legno Giungla

Legno Savana

Essenza Light_ Light wood grains



Matwood Honey

Trama_ Textures



Tela

Rubik

Scult Laccati_ Scult lacquers



Scult Laccato Opaco

Concrete_ Concrete



Selezione Colori Laccati

Laccati_ Lacquers



Laccati Opachi e Lucidi



MAPPA STANZA

Room plan

Location _ 008

Stanza _ K + Disimpegno _ L

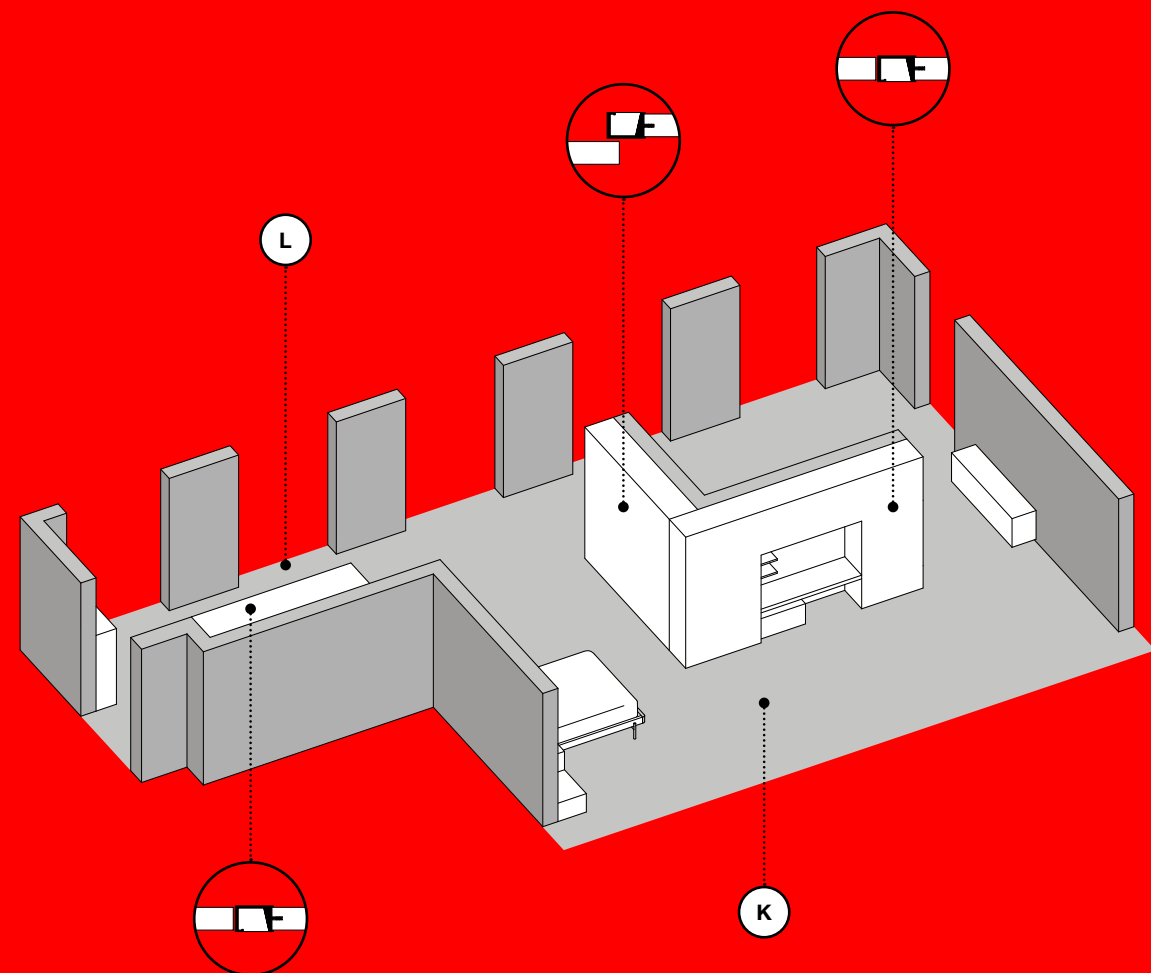

- K** Stanza K _ Letto LOTUS _ Armadio ante scorrevoli e battenti EGO _ Sistema Componibile EGO _ Specchiera AFRODITE
Room K _ LOTUS bed _ EGO sliding- and hinged-door wardrobe _ EGO modular range _ AFRODITE mirror
- L** Disimpegno L _ Armadio ante battenti EGO _ Sistema Componibile EGO
Hallway L _ EGO hinged-door wardrobe _ EGO modular range

Mood materico
Textured moods



Letto _ LOTUS

Bed _ LOTUS

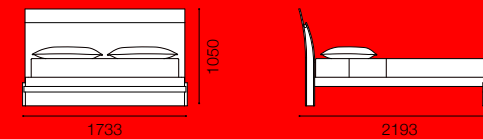

Testiera _ ES Matwood Dark
Headboard _ ES Matwood Dark

Ring _ ES Matwood Dark
Frame _ ES Matwood Dark

Piedino _ VM Black
Foot _ VM Black

Armadio ante scorrevoli e battenti _ EGO

Sliding- and hinged-door wardrobe _ EGO

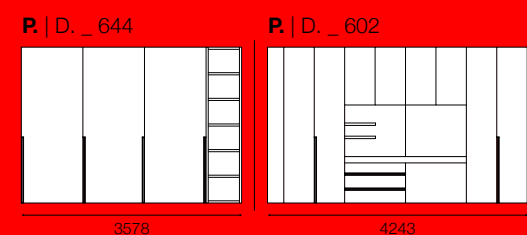

Scocca _ CE Limo
Body _ CE Limo

Anta _ CE Limo
Door _ CE Limo

Ponte _ ES Matwood Dark
Bridging Unit _ ES Matwood Dark

Maniglia _ VM Titanio
Handle _ VM Titanio

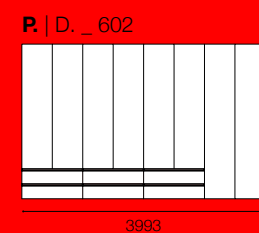

Sistema Componibile _ EGO

Modular range _ EGO

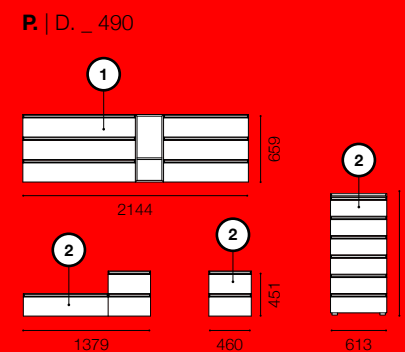

1 **Scocca 1 _ ES Matwood Dark**
Body 1_ ES Matwood Dark

1 **Frontale 1 _ ES Matwood Dark**
Front 1_ ES Matwood Dark

2 **Scocca 2 _ CE Limo**
Body 2_ CE Limo

2 **Frontale 2 _ CE Limo**
Front 2_ CE Limo

Maniglia _ VM Titanio
Handle _ VM Titanio

Specchiera _ AFRODITE

Mirror _ AFRODITE

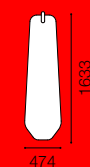

Specchio _ SS Argento
Mirror _ SS Argento



- 178 -

178



● **Scocca e Ante _ ES Matwood Dark**
Body and Doors _ ES Matwood Dark

● **Ponte _ LO Paprika**
Bridging Unit _ LO Paprika

Dimensioni: L.3993 H.2530 P.602
Size: W.3993 H.2530 D.602



● **Scocca e Ante _ ES Matwood Dark**
Body and Doors _ ES Matwood Dark

● **Ponte _ CE Limo**
Bridging Unit _ CE Limo

Dimensioni: L.3497 H.2530 P.602
Size: W.3497 H.2530 D.602



● **Scocca e Ante _ ES Matwood Dark**
Body and Doors _ ES Matwood Dark

● **Ponte _ LO Senape**
Bridging Unit _ LO Senape

Dimensioni: L.3001 H.2530 P.602
Size: W.3001 H.2530 D.602

IT_

L'armadio anta battente EGO può portare strutture a ponte che variano di ampiezza da un minimo di due fino ad un massimo di quattro ante. Le funzioni del vano variano in base alle necessità: possiamo creare una zona spogliatoio con mensole e specchio, uno spazio per lo studio oppure ad uso console trucco. Nella dimensione più ridotta può contenere un pouff imbottito diventando uno spazio utile ad esempio in ingresso. L'estetica del vano si accorda con la finitura della scocca dell'armadio oppure può essere personalizzata a richiesta del cliente.

Homy _ Notte

EN_

The Ego wardrobe with hinged doors can support bridging units of varying widths from two to four doors. The open compartment space can be used for a variety of purposes, from creating a dressing room area with shelves and mirror, to a study space or a console dressing table. For smaller spaces, it can be used to store an upholstered footstool, creating a useful spot in the entrance for example. The compartment can be finished to match the wardrobe body or personalised according to your preferences.

Homy _ Notte





IT_

La maniglia in alluminio finitura Titanio che corre lungo tutta l'anta definisce il sistema Ego; lo stesso profilo di maniglia viene utilizzato nell'anta dell'armadio, sia esso scorrevole o battente. Un sistema trasversale e completo che unisce armadio e gruppo proponendo una soluzione di camera perfettamente coordinata che per la sua semplicità non disprezza di essere anche "spezzata", esattamente come si farebbe con un abito.

EN_

The defining feature of the Ego range is the aluminium Titanio finish handle that runs along the full unit front. The same handle profile is also used on the wardrobe fronts, in both the hinged and sliding-door versions. In this comprehensive, versatile range, the wardrobe and units tie in together, creating the perfect matching bedroom that is simple but can also be broken up, just as you would with an outfit.





IT_

Armadio stagionale e settimanali in un contesto dove l'essere coordinati definisce l'estetica rigorosa eppure accogliente dell'insieme. Il top dei settimanali è la versione più evoluta, caratterizzata dall'essere un vassoio chiuso su tre lati funzionale allo svuotare le tasche oppure a riporvi piccoli oggetti.

EN_

In this context, the large subdivided wardrobe and chest of drawers are coordinated to create a structured yet welcoming overall look. The top featuring on the chest of drawers is the most elaborate, with a tray enclosed on three sides, useful as a valet tray or for trinkets and oddments.

MAPPA STANZA

Room plan

Location _ 009

Stanza _ M

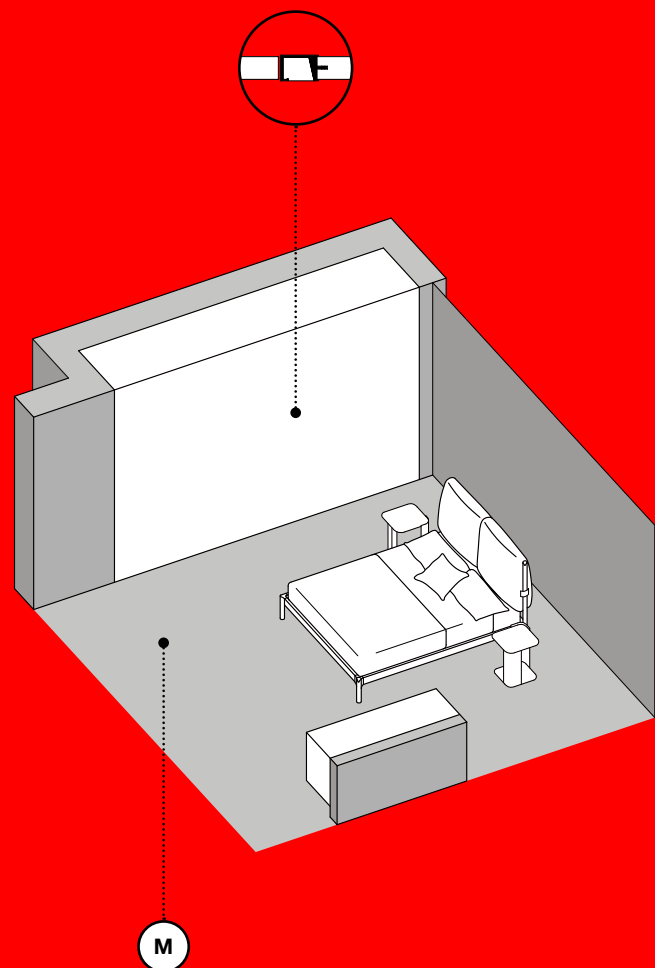

— 188 —

— 189 —

M

Stanza M _ Letto ESPERO _ Armadio ante battenti EGO _ Sistema Componibile EGO _ Tavolino MONET
Room M _ ESPERO bed _ EGO hinged-door wardrobe _ EGO modular range _ MONET occasional table

Mood materico
Textured moods



Letto _ ESPERO

Bed _ ESPERO

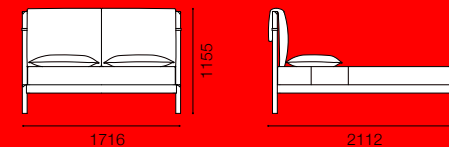

Testiera _ TX Roma 13
Headboard _ TX Roma 13

Ring _ IM Legno Steppa
Frame _ IM Legno Steppa

Armadio ante battenti _ EGO

Hinged-door wardrobe _ EGO

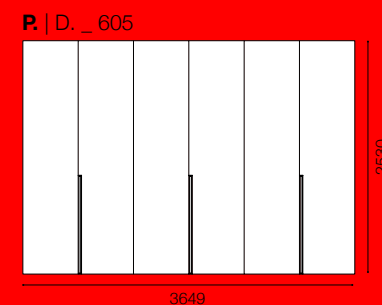

Scocca _ CE Marna
Body _ CE Marna

Anta _ IM Legno Steppa
Door _ IM Legno Steppa

Maniglia _ VM Black
Handle _ VM Black

Sistema Componibile _ EGO

Modular range _ EGO

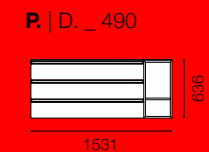

Scocca _ CE Marna
Body _ CE Marna

Frontale _ IM Legno Steppa
Front _ IM Legno Steppa

Maniglia _ VM Black
Handle _ VM Black

Tavolino _ MONET

Occasional table _ MONET

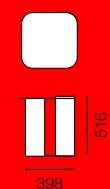

Struttura _ LO Basalto
Frame _ LO Basalto



Dimensioni: L.766 H.628 P.490
Size: W.766 H.628 D.490

● **Scocca e Vano a girono _ CE Marna**
Body and Open Compartment _ CE Marna

● **Frontali _ IM Legno Steppa**
Fronts _ IM Legno Steppa

● **Maniglia e Piedi _ VM Black**
Handles and Feet _ VM Black

Dimensioni: L.1716 H.1155 P.2062
Size: W.1716 H.1155 D.2062

● **Testiera _ TX Bari 666**
Headboard _ TX Bari 666

● **Ring e Struttura _ IM Legno Steppa**
Frame and Structure _ IM Legno Steppa



IT_

Il letto Espero è un letto realizzato interamente in massello ed impiallaccio. È disponibile in rovere nelle quattro tinte ed in tre versioni: con cuscini Wind, con cuscini Cling oppure senza cuscini.

EN_

The Espero bed is made entirely of solid wood and veneer. It is available in oak in four shades and three versions: with Wind cushions, with Cling cushions or without cushions.



IT_

L'armadio battente con anta Ego ed il sistema Ego hanno la possibilità di avere i frontali in finitura impiallacciata in quattro tinte. Ego armadio e Sistema Ego confermano l'essenza di un programma unico ma aperto ad essere abbinato con altri elementi della collezione.

EN_

With the hinged Ego door wardrobe and the other Ego modular units, the fronts can be veneered in a choice of four colours. The Ego wardrobe and Ego modular range are the quintessence of a single but freely adaptable design concept. They furnish your space, coordinating all of the units, but they can be divided up by different elements to create formal structure.



MAPPA STANZA

Room plan

Location _ 010

Stanza _ N

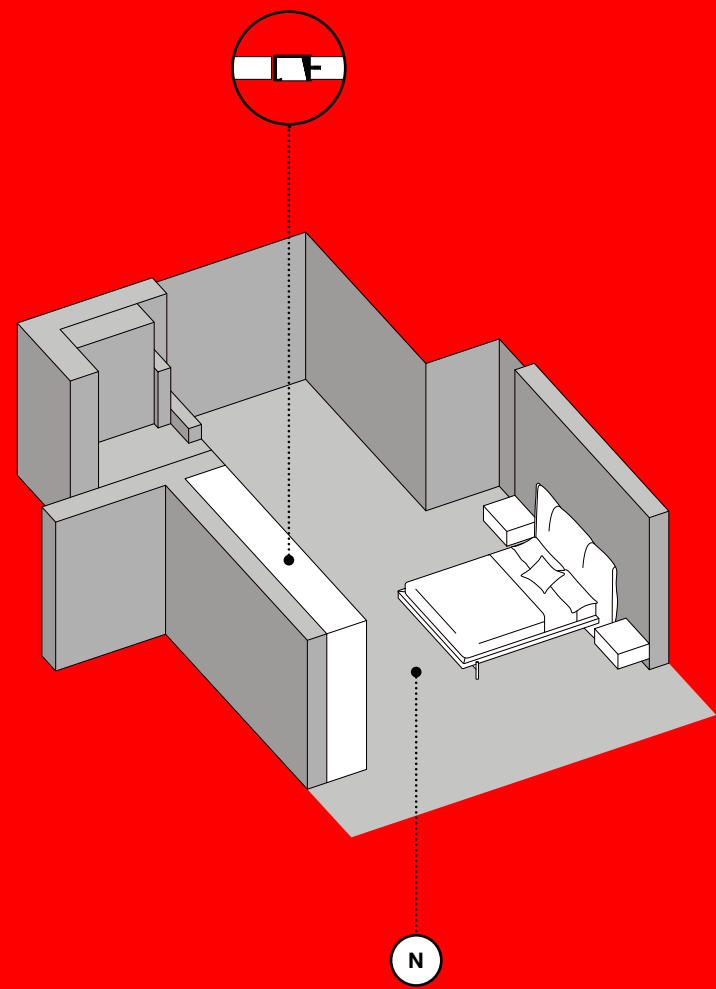

Stanza N _ Letto GHIBLI _ Armadio ante battenti EGO _ Sistema Componibile EGO _ Specchiera MAIA
 Room N _ GHIBLI bed _ EGO hinged-door wardrobe _ EGO modular range _ MAIA mirror

Mood materico
 Textured moods



Letto _ GHIBLI

Bed _ GHIBLI

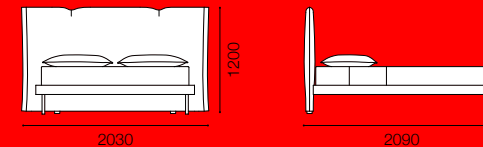

Testiera 1 _ TX Genova 105
 Headboard 1 _ TX Genova 105

Ring _ EX Paris 140
 Frame _ EX Paris 140

Armadio ante battenti _ EGO

Hinged-door wardrobe _ EGO

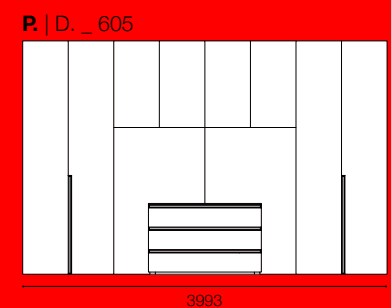

Scocca _ CE Limo
 Body _ CE Limo

Anta _ CE Limo
 Door _ CE Limo

Ponte _ LO Cuoio
 Bridging Unit _ LO Cuoio

Maniglia _ VM Black
 Handle _ VM Black

Sistema Componibile _ EGO

Modular range _ EGO

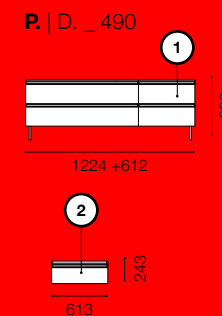

1 **Scocca 1 _ LO Cuoio**
 Body 1 _ LO Cuoio

1 **Frontale 1 _ LO Cuoio**
 Front 1 _ LO Cuoio

2 **Scocca 2 _ CE Limo**
 Body 2 _ CE Limo

2 **Frontale 2 _ CE Limo**
 Front 2 _ CE Limo

Staffe _ VM Black
 Brackets _ VM Black

Maniglia _ VM Black
 Handle _ VM Black

Specchiera _ MAIA

Mirror _ MAIA

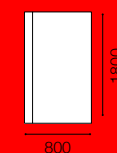

Specchio _ SS Argento
 Mirror _ SS Argento

Struttura _ ES Matwood Dark
 Frame _ ES Matwood Dark



109

109



IT_

La particolarità del letto Ghibli sta nel rivestimento del giroletto e della testiera: infatti la falda interna laterale della testiera è sempre rivestita in ecopelle ed in questo caso è coerente al giroletto facilitando così le operazioni di pulizia, soprattutto se si ha un animale da compagnia in casa.

EN_

The Ghibli bed features distinctive upholstery on the frame and headboard. The inner hem along the sides of the headboard is upholstered in eco-leather. Here, it joins with the bed frame, making it easier to clean, especially if you have a pet.



Dimensioni: L.3001 H.2530 P.602
Size: W.3001 H.2530 D.602

● **Scocca e Ante _ CE Limo**
Body and Doors _ CE Limo

● **Maniglia _ VM Titano**
Handle _ VM Titano

- 204 -



- 205 -





IT_

La specchiera Maia, disponibile in tre misure, è uno specchio dalle linee pulite che si coordina agli altri elementi della camera. Questo elemento laterale ha inoltre in dotazione opzionale la possibilità di portare un'illuminazione a led sullo spessore interno a contatto con lo specchio. Questa configurazione permette di sfruttare la specchiera anche in altri luoghi della casa: zona d'ingresso, bagno, corridoi o stanze di servizio.

EN_

The Maia mirror is available in three sizes. It features clean lines and matches the other elements in the room. The side feature panel can also be fitted with optional LED lighting along the internal edge touching the mirror. This makes the mirror easy to place in other parts of the house such as the entrance, bathroom, hallway/landing or utility room.

MAPPA STANZA

Room plan

Location _ 011

Stanza _ O

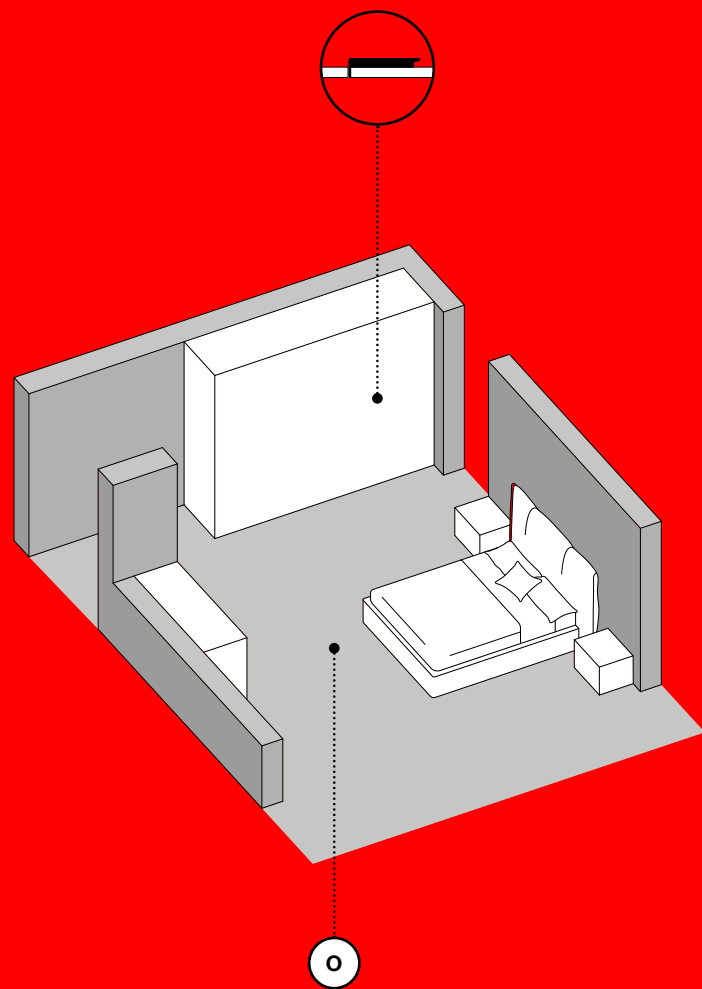

Letto _ GHIBLI BOX

Bed _ GHIBLI BOX

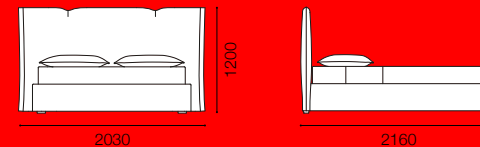

● **Testiera e Ring _ TX Genova 205**
Frame and Headboard _ TX Genova 205

Armadio ante battenti _ DOUBLE

Hinged-door wardrobe _ DOUBLE

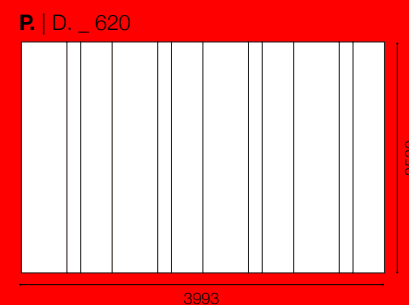

● **Scocca _ CE Limo**
Body _ CE Limo

● **Anta _ CE Limo**
Door _ CE Limo

● **Maniglia _ ES Matwood Coffee**
Handle _ ES Matwood Coffee

Collezione _ DOLOMITE

Collection _ DOLOMITE

P. | D. _ 402 P. | D. _ 489

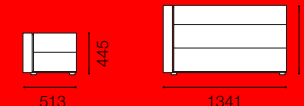

● **Scocca _ CE Limo**
Body _ CE Limo

● **Frontale _ CE Limo**
Front _ CE Limo

● **Fiancone _ ES Matwood Coffee**
Large Side Panel _ ES Matwood Coffee

Mood materico
Textured moods



○ **Stanza O _ Letto GHIBLI BOX _ Armadio ante battenti DOUBLE _ Collezione DOLOMITE**
Room O _ GHIBLI BOX bed _ DOUBLE hinged-door wardrobe _ DOLOMITE collection







MAPPA STANZA

Room plan

Location _ 012

Stanza _ P + Disimpegno _ Q

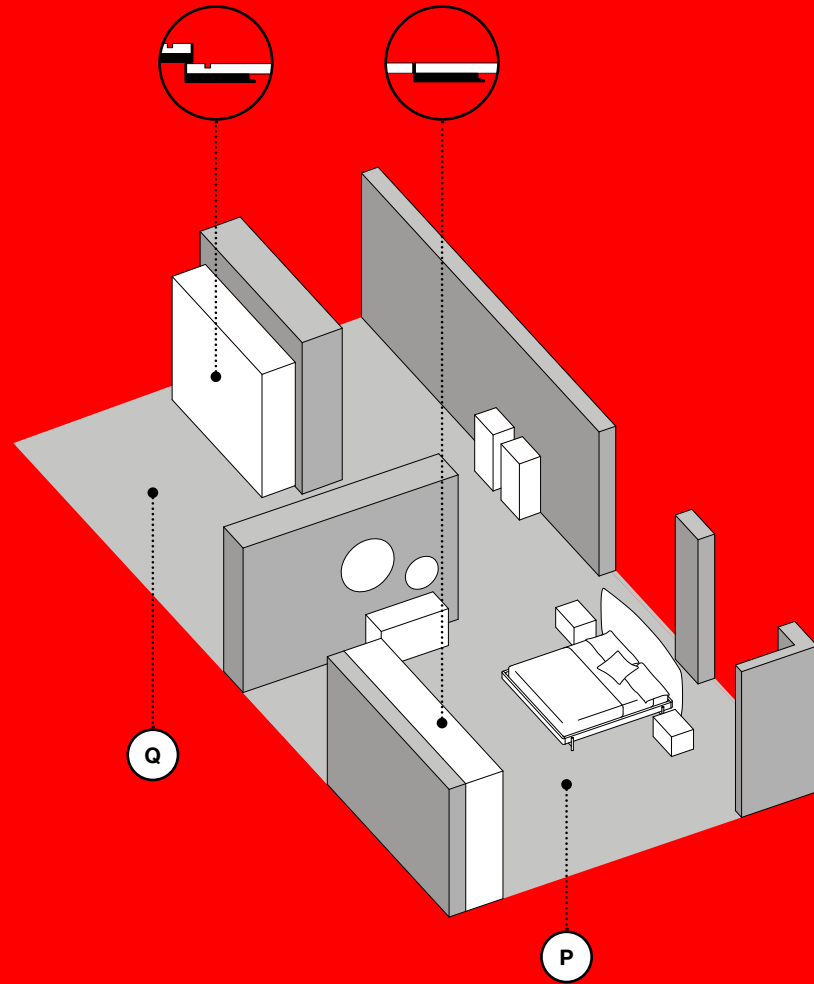

P Stanza P _ Letto BALI _ Armadio ante battenti DOUBLE _ Collezione QUADRO 12 _ Specchiere CHIMERA
Room P _ BALI bed _ DOUBLE hinged-door wardrobe _ QUADRO 12 collection _ CHIMERA mirrors

Q Disimpegno Q _ Armadio ante scorrevoli DOUBLE _ Collezione QUADRO 12
Hallway Q _ DOUBLE sliding-door wardrobe _ QUADRO 12 collection

Mood materico
Textured moods

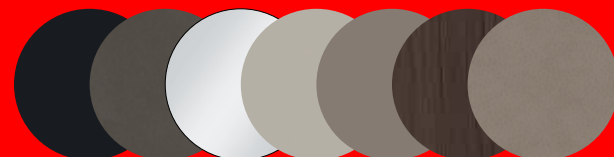

Letto _ BALI

Bed _ BALI

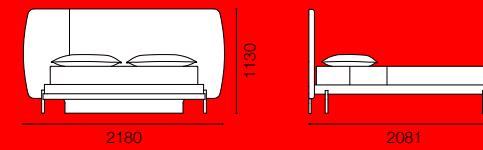

Testiera _ EX Paris 750
Headboard _ EX Paris 750

Ring _ ES Matwood Dark
Frame _ ES Matwood Dark

Piedini _ VM Black
Feet _ VM Black

Armadio ante battenti e scorrevoli _ DOUBLE

Hinged and sliding-door wardrobe _ DOUBLE

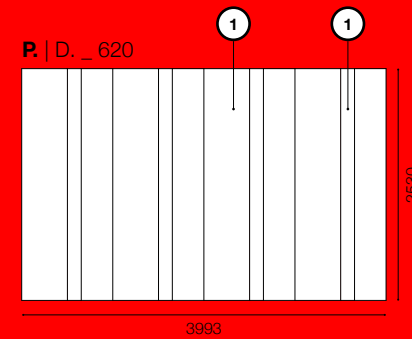

1 **Scocca _ CE Pepe**
Body _ CE Pepe

2 **Scocca _ CE Limo**
Body _ CE Limo

1 **Anta _ CE Pepe**
Door _ CE Pepe

2 **Anta _ CE Limo**
Door _ CE Limo

1 **Maniglia _ CE Pepe**
Handle _ CE Pepe

2 **Maniglia _ EX Paris 750**
Handle _ EX Paris 750

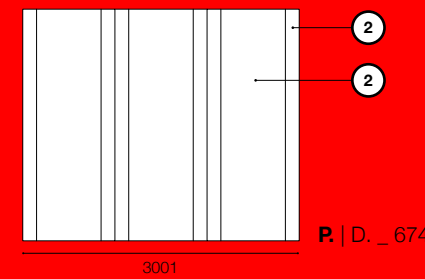

Collezione _ QUADRO 12

Collection _ QUADRO 12

P | D. _ 400 **P | D. _ 500** **P | D. _ 400**

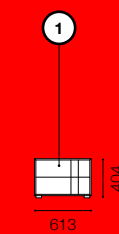
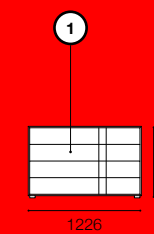
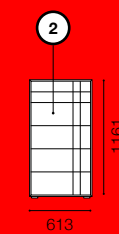

1 **Scocca _ CE Pepe**
Body _ CE Pepe

2 **Scocca _ CE Limo**
Body _ CE Limo

1 **Frontale _ CE Pepe**
Front _ CE Pepe

2 **Frontale _ CE Limo**
Front _ CE Limo

1 **Maniglia _ VM Titanio**
Handle _ VM Titanio

2 **Maniglia _ EX Paris 750**
Handle _ EX Paris 750

Specchiera _ CHIMERA

Mirror _ CHIMERA

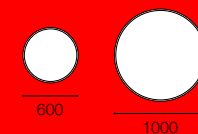

Specchio _ SS Argento
Mirror _ SS Argento

Struttura _ ES Matwood Dark
Frame _ ES Matwood Dark







IT_

Nel dettaglio l'attrezzatura interna degli armadi e in particolare il porta scarpe estraibile su telaio in alluminio. Questo accessorio per l'armadio è una soluzione utile per organizzare lo spazio con eleganza; la finitura Titanio si coordina al resto dell'attrezzatura come ad esempio il telaio dei ripiani in vetro.

EN_

The internal wardrobe fittings include a pull-out shoe rack with an aluminium frame. This wardrobe accessory is useful for elegantly organising your space. The Titanio finish matches the rest of the fittings such as the glass-shelf frame.





sezione _ **battenti**

Section _ Hinged doors

003_

ROMANTIC

MOOD

IT_

Restaurare vecchi immobili in zone rurali sta diventando sempre più un trend trainante: in molti infatti decidono di abbandonare la giungla urbana moderna per riavvicinarsi ad un mondo antico senza rinunciare al comfort di un arredamento contemporaneo e raffinato, che soddisfi al meglio le esigenze della vita odierna. Ne nasce uno stile nuovo, alcuni lo chiamano "modernico".

EN_

Renovating old buildings in the rural countryside is becoming an increasingly popular trend. Many are making the decision to leave behind the modern urban jungle to move closer to yesterday's world – without compromising on the comforts of elegant, contemporary interior design to meet the needs of modern life. A new style has been born in which tradition and modernity combine.



MAPPA STANZA

Room plan

Location _ 001

Stanza _ **A** + Disimpegno _ **B**

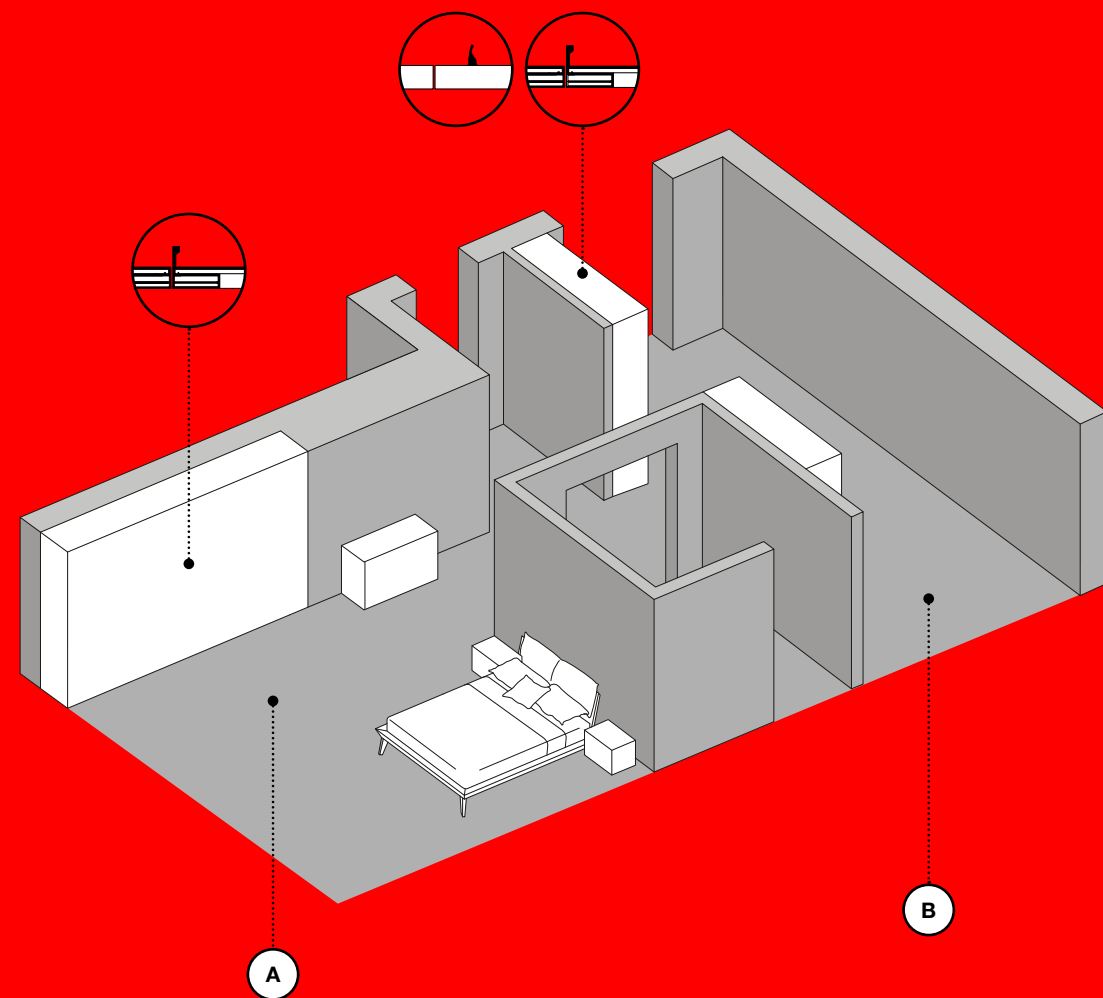

A Stanza A _ Letto TALAK _ Armadio ante battenti NOCTA _ Collezione QUADRO FILO _ Tavolino MIRÓ _ Specchiera MAIA
Room A _ TALAK bed _ NOCTA hinged-door wardrobe _ QUADRO FILO collection _ MIRÓ occasional table _ MAIA mirror

B Disimpegno B _ Armadio ante battenti NOCTA/LISCIA
Hallway B _ NOCTA/LISCIA hinged-door wardrobe

Mood materico
Textured moods



Letto _ TALAK

Bed _ TALAK

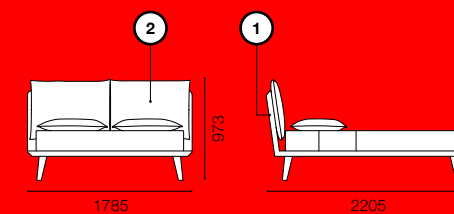

1 Testiera 1 _ IM Legno Giungla
Headboard 1 _ IM Legno Giungla

1 Ring _ IM Legno Giungla
Frame _ IM Legno Giungla

2 Testiera 2 _ TX Bari 617
Headboard 2 _ TX Bari 617

Armadio anta battente _ NOCTA/LISCIA

Hinged-door wardrobe _ NOCTA/LISCIA

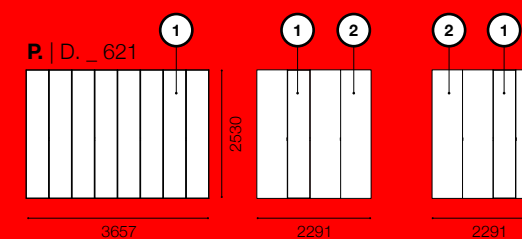

1 Scocca _ CE Pepe
Body _ CE Pepe

1 Anta 1 _ VS Stopsol
Door 1 _ VS Stopsol

2 Telaio _ VM Titanio
Frame _ VM Titanio

2 Anta 2 _ IM Legno Giungla
Door 2 _ IM Legno Giungla

Collezione _ QUADRO FILO

Collection _ QUADRO FILO

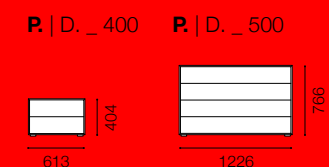

1 Scocca _ CE Pepe
Body _ CE Pepe

1 Frontale _ CE Pepe
Front _ CE Pepe

Tavolino _ MIRÓ

Occasional table _ MIRÓ

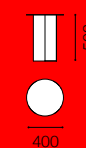

1 Struttura _ LO Basalto
Frame _ LO Basalto

Specchiera _ MAIA

Mirror _ MAIA

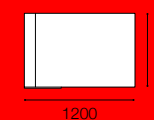

1 Specchio _ SS Argento
Mirror _ SS Argento

1 Struttura _ ES Matwood Dark
Frame _ ES Matwood Dark





234

235





Dimensioni: L.3657 H.2530 P.615

Size: W.3657 H.2530 D.615

● **Ante e Fianchi _ VS Stopsol**
Doors and Side Panels _ VS Stopsol

● **Profilo Ante _ VM Titanio**
Door profile _ VM Titanio

● **Interno _ ES Matwood Dark**
Interior _ ES Matwood Dark

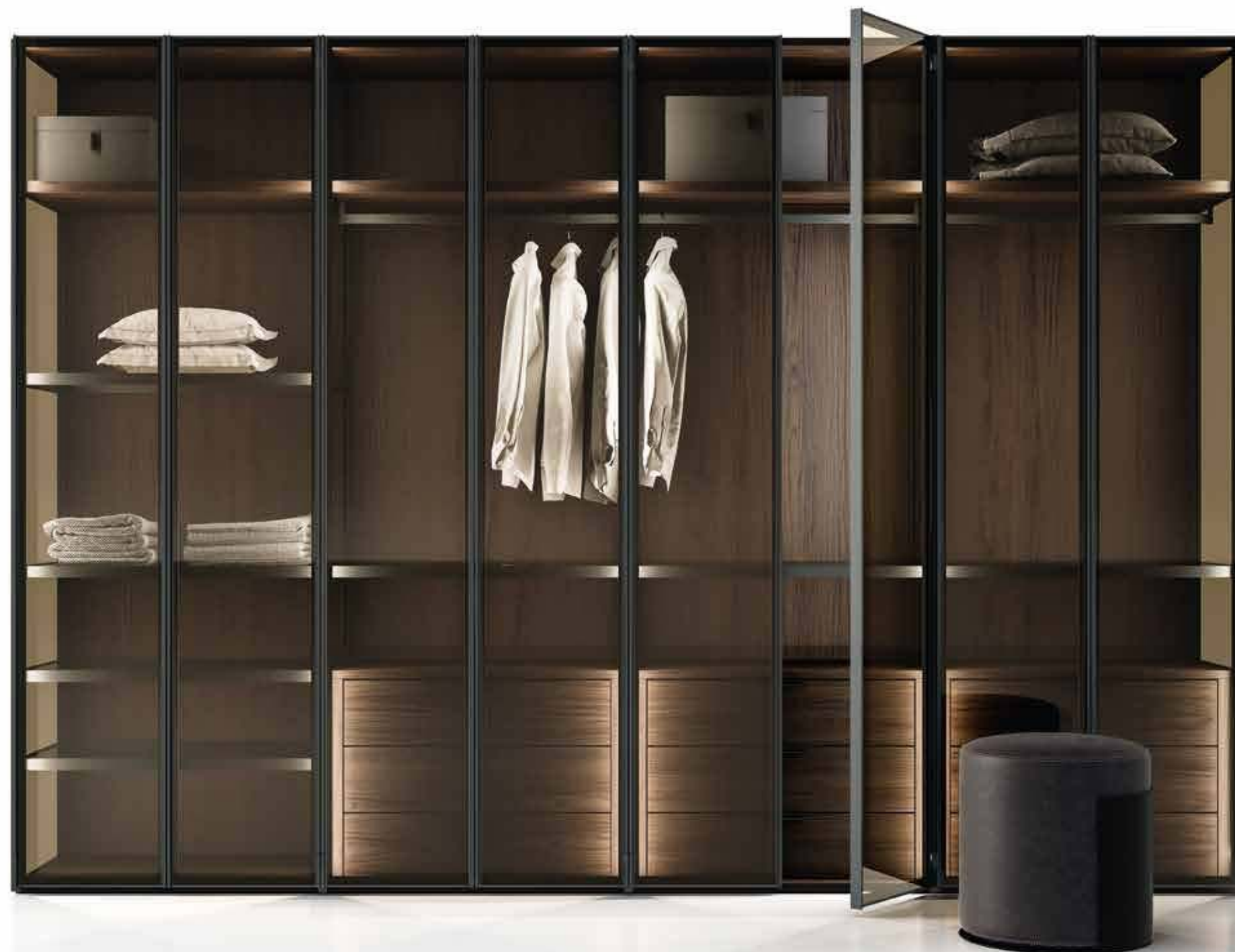

— 240 —

— 241 —

IT_

Luxury è un armadio con fianchi e ante in vetro, una soluzione che si avvicina concettualmente alla cabina armadio, mantenendo tuttavia il contenimento di un armadio. La particolarità di avere anche i fianchi in vetro porta ad avere un'attrezzatura interna completamente dedicata e coordinata stilisticamente.

EN_

The Luxury wardrobe features glass sides and doors. Conceptually, it resembles a walk-in wardrobe, while offering all of the storage features of a traditional wardrobe. The unique glass sides mean that the internal fittings have all been specially designed and their style is fully coordinated.



MAPPA STANZA

Room plan

Location _ 001

Stanza _ **C** + Disimpegno _ **D**

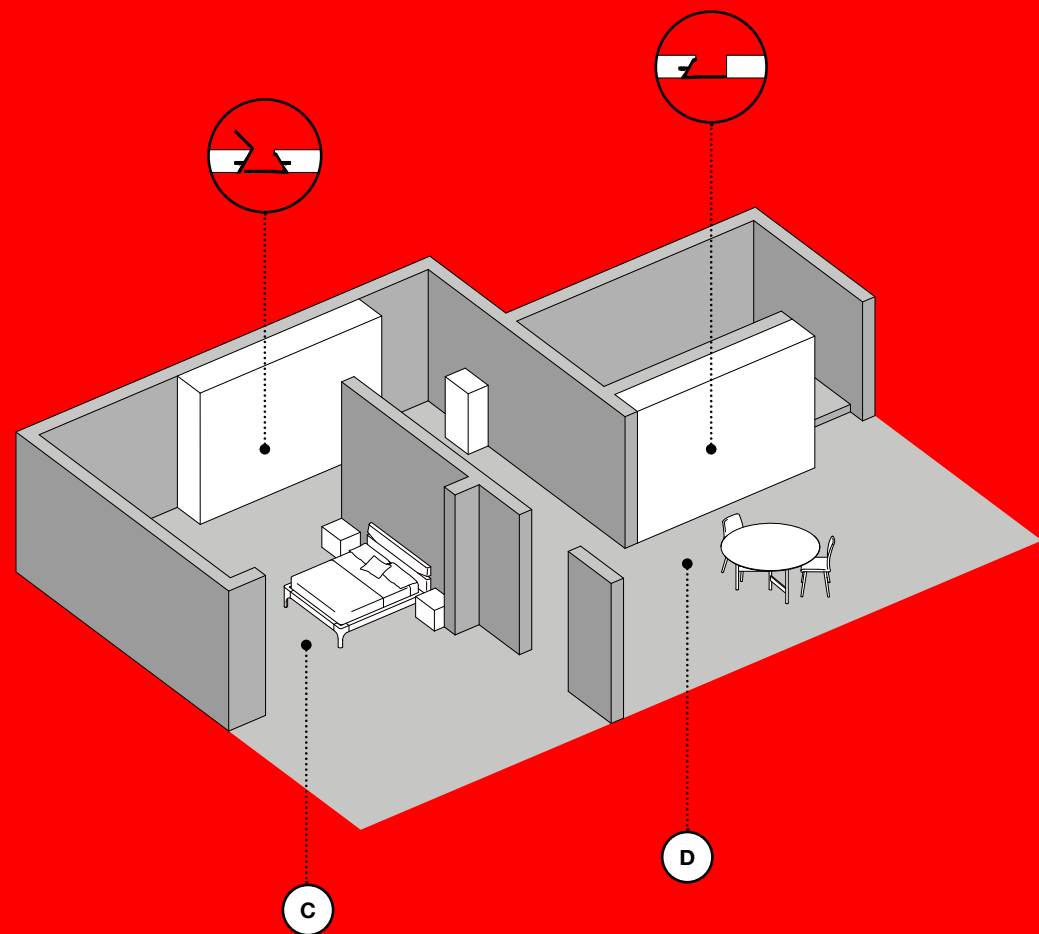

C Stanza C _ Letto GRECALE _ Armadio ante battenti TANDEM _ Collezione QUADRO FILO
Room C _ GRECALE bed _ TANDEM hinged-door wardrobe _ QUADRO FILO collection

D Disimpegno D _ Armadio ante battenti METAL _ Tavolo NORBET _ Sedia RAY
Hallway D _ METAL hinged-door wardrobe _ NORBET table _ RAY chair

Mood materico
Textured moods



Letto _ GRECALE

Bed _ GRECALE

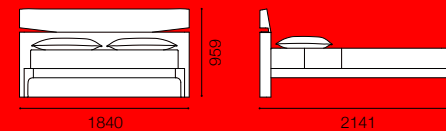

Testiera _ ES Matwood Grey
Headboard _ ES Matwood Grey

Ring _ ES Matwood Grey
Frame _ ES Matwood Grey

Armadio ante battenti _ TANDEM

Hinged-door wardrobe _ TANDEM

P | D _ 620

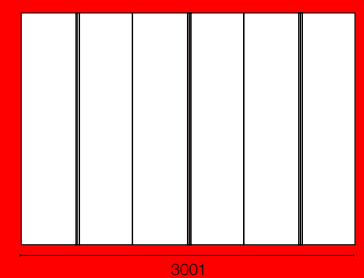

Scocca _ CE Limo
Body _ CE Limo

Anta _ TS Limo
Door _ TS Limo

Maniglia _ VM Black
Handle _ VM Black

Armadio ante battenti _ METAL

Hinged-door wardrobe _ METAL

P | D _ 602

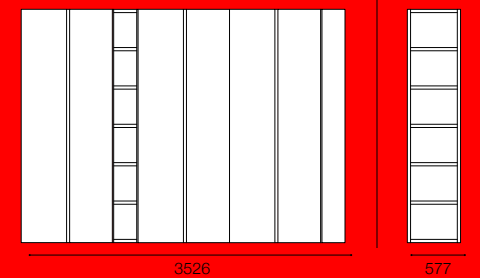

Scocca _ CE Limo
Body _ CE Limo

Anta _ CE Limo
Door _ CE Limo

Elementi a Giorno _ LO Petrolio
Open Compartments _ LO Petrolio

Maniglia _ LO Limo
Handle _ LO Limo

Collezione _ QUADRO FILO

Collection _ QUADRO FILO

P | D _ 400

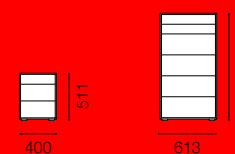

Scocca _ LO Petrolio
Body _ LO Petrolio

Frontale _ LO Petrolio
Front _ LO Petrolio

Tavolo e Sedie _ RAY e NORBET

Table and chairs _ RAY and NORBET

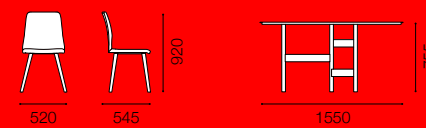

Piano _ LM Piasentino
Top _ LM Piasentino

Struttura _ VM Black
Frame _ VM Black

Struttura _ IM Legno Palude
Frame _ IM Legno Palude

Seduta _ TX Fenice 602
Seat _ T Fenice 602



- 246 -

- 247 -



— 276 —

— 276 —

Dimensioni: L.613 H.1161 P.400
Size: W.613 H.1161 D.400

● **Frontali e Scocca _ CE Limo**
Fronts and Body _ CE Limo

Dimensioni: L.1226 H.766 P.500
Size: W.1226 H.766 D.500

● **Scocca _ LO Petrolio**
Body_ LO Petrolio

● **Frontali _ MT Petrolio**
Fronts _ MT Petrolio

Dimensioni: L.400 H.511 P.400
Size: W.400 H.511 D.400

● **Frontali e Scocca _ LO Nevada**
Fronts and Body _ LO Nevada

Dimensioni: L.613 H.404 P.400
Size: W.613 H.404 D.400

● **Frontali e Scocca _ ES Matwood Grey**
Fronts and Body _ ES Matwood Grey

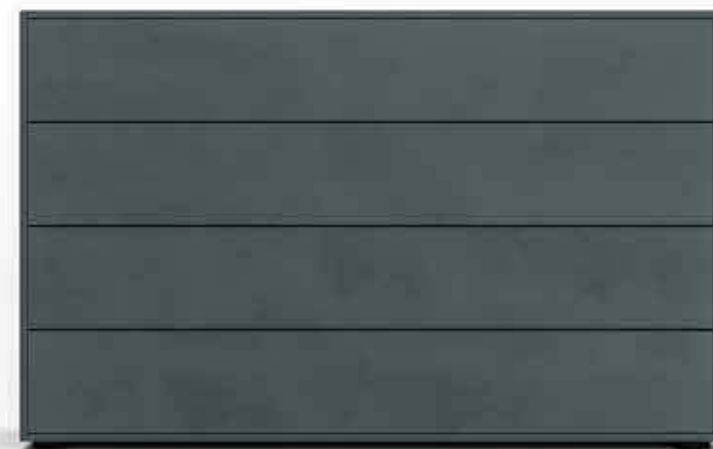

-- 250 --

-- 251 --

IT_

Quadro Filo, Quadro 12 e Quadro Darsena rappresentano delle varianti formali e stilistiche di unico gruppo caratterizzato dalla scocca in folding e dalle ante a filo. Qui possiamo apprezzare in diverse finiture la versione più minimalista ovvero il Quadro Filo.

EN_

Quadro Filo, Quadro 12 and Quadro Darsena are three variations on the same group of units featuring a frame made using the folding technique and doors flush to the fronts. Here you can see the most minimalist version in form and style, Quadro Filo, in different finishes.



- 252 -



- 253 -

IT_

Il modello Grecale è un letto completamente in finitura Essenza caratterizzato da un segno grafico deciso sulla testiera. In corrispondenza di questo taglio è collocato un sensore touch con il quale è possibile accendere e spegnere una piccola luce di servizio. Questa testiera, così come altre, può portare diverse configurazioni di ring: Piede Curvo, Tender, Staffa, Plexi, Box.

EN_

The Grecale bed is fully finished in wood grain with a bold headboard design feature. There is also a touch sensor in the opening that controls a small service light. This headboard, among others, can be used with different bed frame configurations: Piede Curvo, Tender, Staffa, Plexi, Box.





IT_

La maniglia dell'anta Tandem è caratterizzata da un doppio profilo metallico che corre in senso verticale lungo le due ante. L'unicità di questa combinazione ruota intorno ad un gioco tridimensionale per il quale un profilo crea la presa sporgente e l'altro una presa contrapposta ricavata nello spessore inclinato dell'anta. Un'altra particolarità di questo modello è la finitura Tissù disponibile in due colori: bianco e limo.

EN_

The handle on the Tandem door features a double metal profile that runs vertically up the two doors. What makes this combination unique is the 3D effect created by one profile protruding as a hand grip while the other is carved inwards into the angled depth of the door. Another feature of this model is the Tissù finish, which comes in two colours: Bianco and Limo.

MAPPA STANZA

Room plan

Location _ 002

Stanza _ E

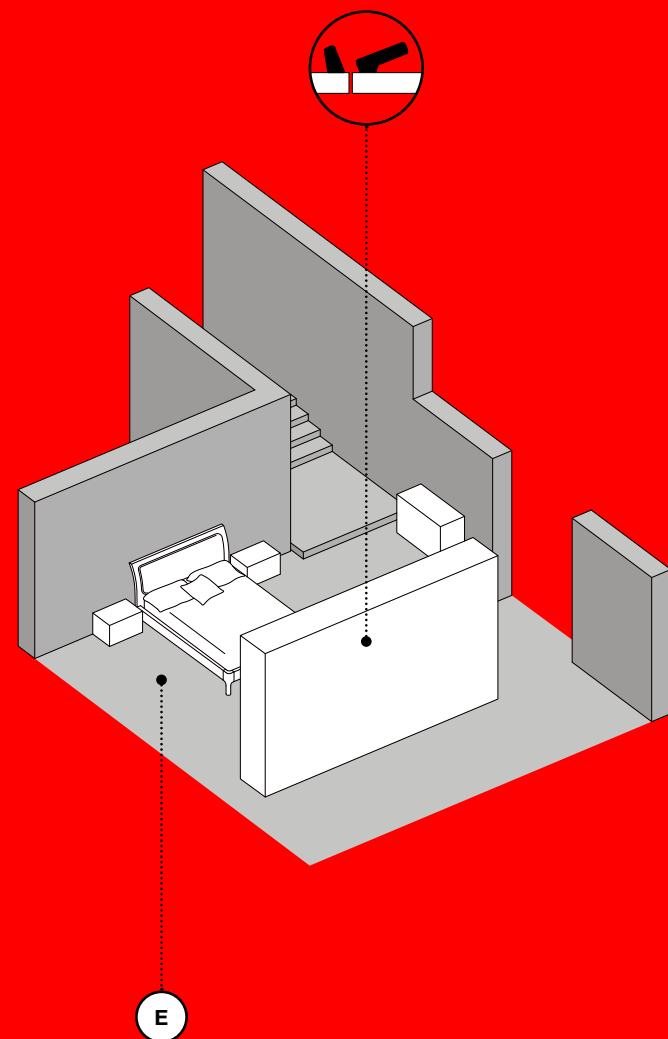

— 258 —

— 259 —

E

Stanza E _ Letto PARENTESI _ Armadio ante battenti DARSENA _ Collezione QUADRO DARSENA _ Specchiera ATENA
Room E _ PARENTESI bed _ DARSENA hinged-door wardrobe _ QUADRO DARSENA collection _ ATENA mirror

Mood materico
Textured moods



Letto _ PARENTESI

Bed _ PARENTESI

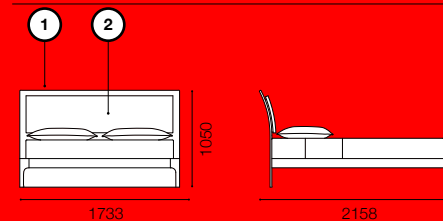

1 **Testiera 1 _ ES Matwood White**
Headboard 1 _ ES Matwood White

Ring _ ES Matwood White
Frame _ ES Matwood White

2 **Testiera 2 _ TX Genova 619**
Headboard 2 _ TX Genova 619

Armadio ante battenti _ DARSENA

Hinged-door wardrobe _ DARSENA

P. | D. _ 634

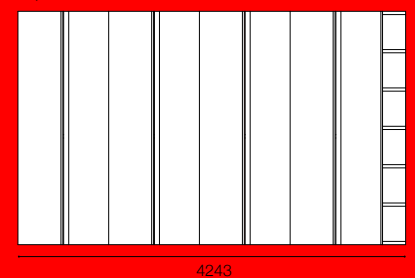

Scocca _ ES Matwood White
Body _ ES Matwood White

Anta _ ES Matwood White
Door _ ES Matwood White

Elementi a giorno _ ES Matwood White
Open Compartments _ ES Matwood White

Collezione _ QUADRO DARSENA

Collection _ QUADRO DARSENA

P. | D. _ 431

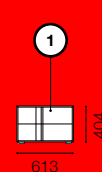

P. | D. _ 531

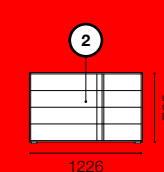

1 **Scocca _ LO Nevada**
Body _ LO Nevada

1 **Frontale _ LO Nevada**
Front _ LO Nevada

2 **Scocca _ ES Matwood White**
Body _ ES Matwood White

2 **Frontale _ ES Matwood White**
Front _ ES Matwood White

Specchiera _ ATENA

Mirror _ ATENA

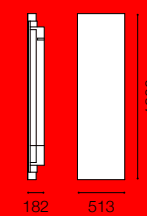

Specchio _ SS Argento
Mirror _ SS Argento

Struttura _ VM Black
Frame _ VM Black









MAPPA STANZA

Room plan

Location _ 003

Stanza _ F

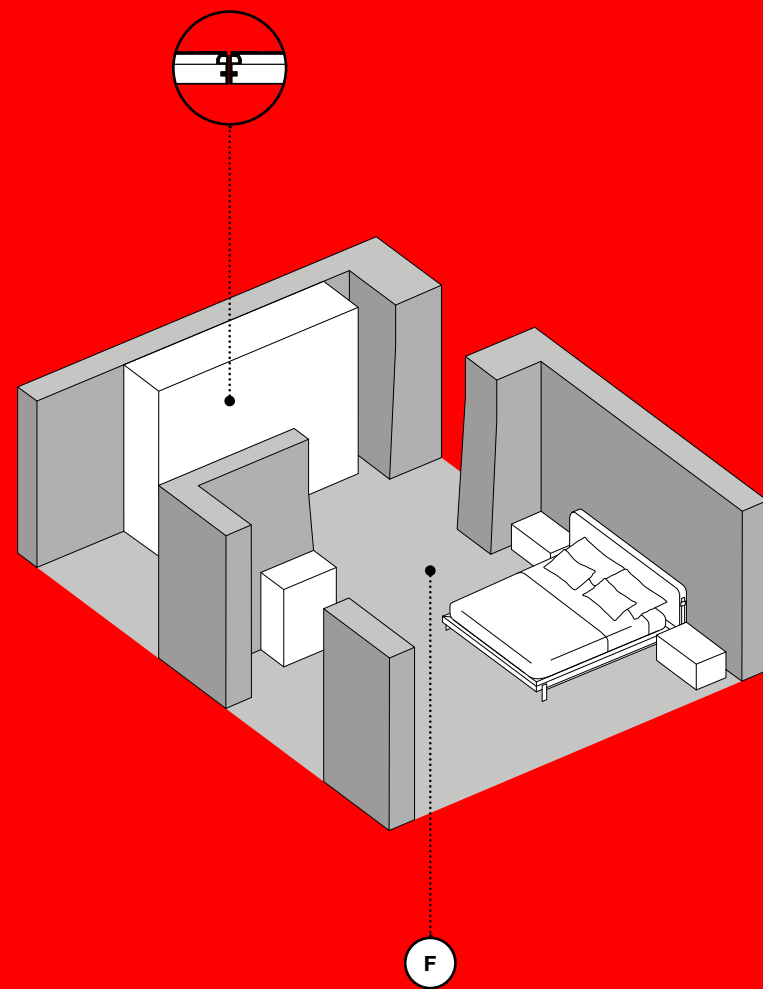

Letto _ ADAM

Bed _ ADAM

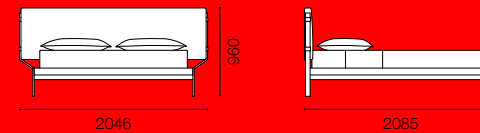

Testiera _ TX Roma 46
Headboard _ TX Roma 46

Ring _ ES Matwood Grey
Frame _ ES Matwood Grey

Piedini _ VM Titanio
Feet _ VM Titanio

Armadio ante battenti _ ESTETA

Hinged-door wardrobe _ ESTETA

P. | D. _ 608

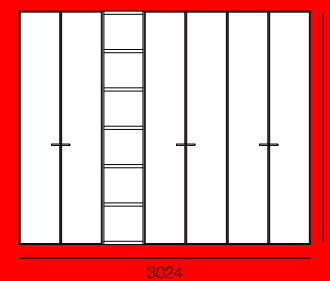

Scocca _ CE Pepe
Body _ CE Pepe

Anta _ CE Pepe
Door _ CE Pepe

Elementi a giorno _ LO Cipria
Open Compartments _ LO Cipria

Maniglia _ VM Titanio
Handle _ VM Titanio

Collezione _ ONICE

Collection _ ONICE

P. | D. _ 498

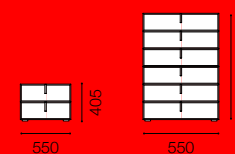

Scocca _ ES Matwood Grey
Body _ ES Matwood Grey

Frontale _ ES Matwood Grey
Front _ ES Matwood Grey

Maniglia _ VM Titanio
Handle _ VM Titanio

F Stanza F _ Letto ADAM _ Armadio ante battenti ESTETA _ Collezione ONICE
Room F _ ADAM bed _ ESTETA hinged-door wardrobe _ ONICE collection

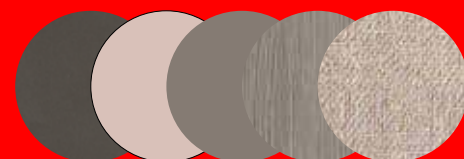

Mood materico
Textured moods







Dimensioni: L.2046 H.960 P.2085
Size: W.2046 H.960 D.2085

-  **Testiera _ TX Paris 20**
Headboard _ TX Paris 20
-  **Ring _ ES Matwood Coffee**
Frame _ ES Matwood Coffee
-  **Struttura _ VM Titanio**
Structure _ VM Titanio



- 274 -

- 275 -



Dimensioni: L.4857 H.2530 P.608

Size: W.4857 H.2530 D.608

 **Frontali e Scocca _ CE Limo**
Fronts and Body _ CE Limo

 **Frontali _ TX Paris 20**
Fronts _ TX Paris 20

 **Maniglie _ VM Titanio**
Handles _ VM Titanio



- 278 -

IT_

L'armadio con anta battente Esteta è dotata di maniglia dedicata che avvolge l'esclusiva cornice. Nella variante con rivestimento in ecopelle l'apertura dell'anta avviene tramite Push & Pull.

EN_

The Esteta wardrobe has hinged doors and its own handle that embraces the exclusive framed design. For the model with an eco-leather covering, the door has a push-pull opening.

Dimensioni: L.1100 H.795 P.498

Size: W.1100 H.795 D.498

 **Frontali e Scocca _ CE Limo**
Fronts and Body _ CE Limo

 **Maniglie _ VM Titanio**
Handles _ VM Titanio



- 279 -

MAPPA STANZA

Room plan

Location _ 004

Stanza _ G

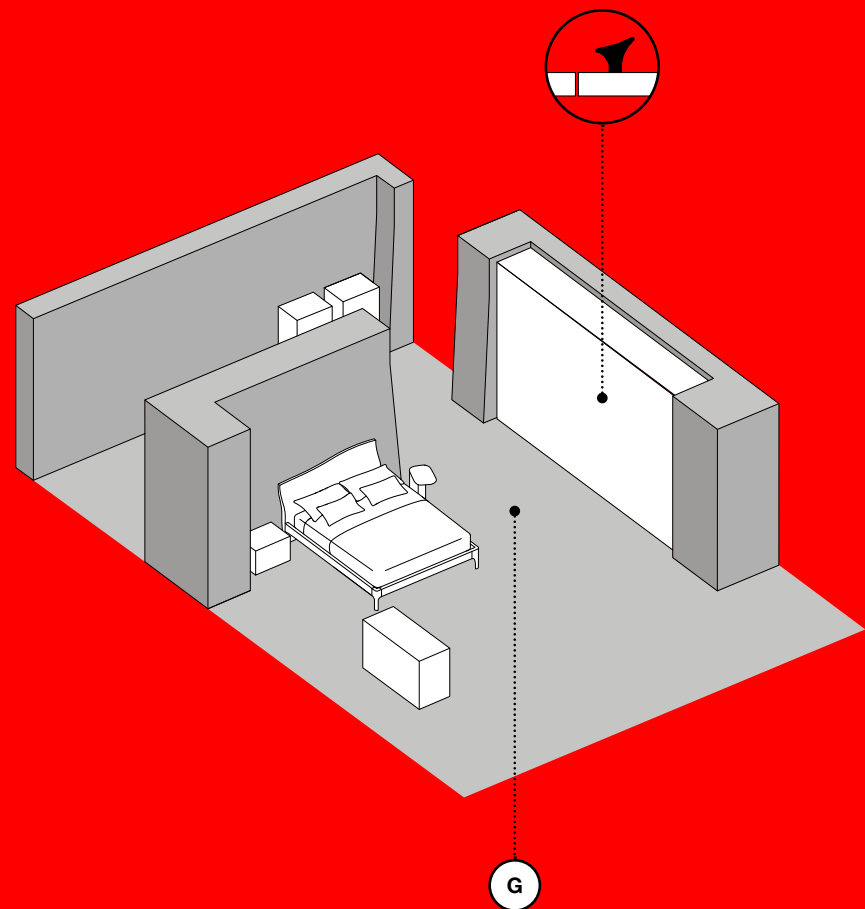

Letto _ WAVE

Bed _ WAVE

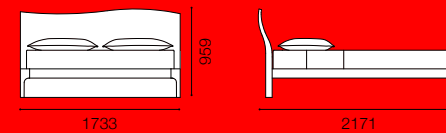

Testiera _ ES Matwood Coffee
Headboard _ ES Matwood Coffee

Ring _ ES Matwood Coffee
Frame _ ES Matwood Coffee

Armadio ante battenti _ TWIN

Hinged-door wardrobe _ TWIN

P. | D. _ 637

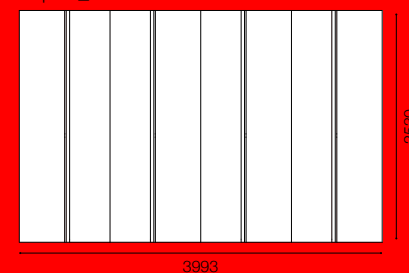

Scocca _ CE Limo
Body _ CE Limo

Anta _ CE Limo
Door _ CE Limo

Maniglia _ ES Matwood Coffee
Handle _ ES Matwood Coffee

Collezione _ SPOT MIX

Collection _ SPOT MIX

P. | D. _ 445

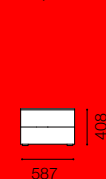

P. | D. _ 540

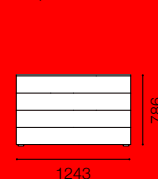

P. | D. _ 445

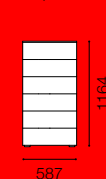

Scocca _ ES Matwood Coffee
Body _ ES Matwood Coffee

Frontale _ ES Matwood Coffee
Front _ ES Matwood Coffee

G

Stanza G _ Letto WAVE _ Armadio ante battenti TWIN _ Collezione SPOT MIX _ Tavolino DA VINCI
Room G _ WAVE bed _ TWIN hinged-door wardrobe _ SPOT MIX collection _ DA VINCI occasional table

Mood materico
Textured moods



Tavolino _ DA VINCI

Occasional table _ DA VINCI

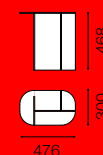

Struttura _ Stopsol con serigrafia a sfumare
Frame _ stopsol with to fade silkscreen.



- 282 -

- 283 -



IT_

Da Vinci è un complemento versatile che può essere usato a servizio del letto in sostituzione del comodino laddove lo spazio è poco. La particolarità di questo tavolino sta nella trasparenza del vetro combinata con una sfumatura colorata progressivamente coprente. Il risultato estetico è coinvolgente e affascinante, l'oggetto infatti cambia estetica in relazione alla luce ed al punto di vista.

EN_

Da Vinci is a versatile piece of furniture that can be used instead of a bedside cabinet, where space is at a premium. The stand-out feature of this occasional table is the see-through coloured glass which becomes progressively more opaque. The result is eye-catching and has real appeal, as the piece looks different from different angles and as the light in the room changes.



**MAPPA
STANZA**

Room plan

Location _ 005

Stanza _ **H**

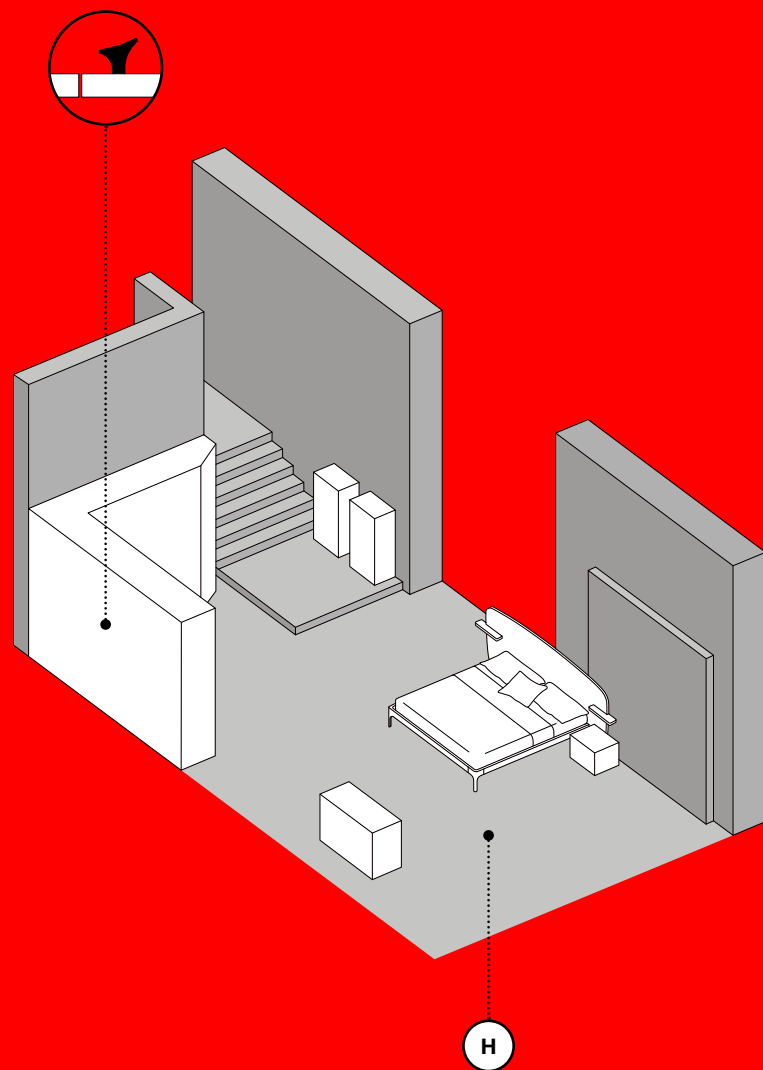

H

Stanza H _ Letto NASHI _ Armadio ante battenti TWIN _ Collezione OPALE _ Pouf CARAVAGGIO _ Specchiera AFRODITE
Room H _ NASHI bed _ TWIN hinged-door wardrobe _ OPALE collection _ CARAVAGGIO footstool _ AFRODITE mirror

Mood materico
Textured moods



Letto _ NASHI

Bed _ NASHI

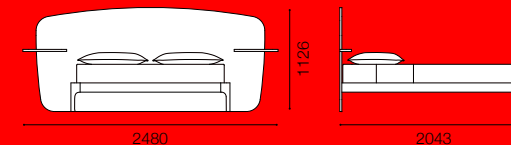

Testiera _ ES Matwood Dark
Headboard _ ES Matwood Dark

Ring _ ES Matwood Dark
Frame _ ES Matwood Dark

Armadio ante battenti _ TWIN

Hinged-door wardrobe _ TWIN

P. | D. _ 637

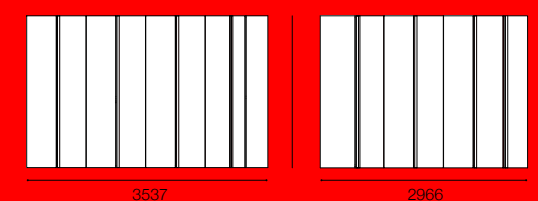

Scocca _ CE Limo
Body _ CE Limo

Anta _ CE Limo
Door _ CE Limo

Maniglia _ CE Limo
Handle _ CE Limo

Collezione _ OPALE

Collection _ OPALE

P. | D. _ 432

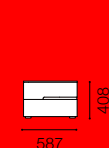

P. | D. _ 519

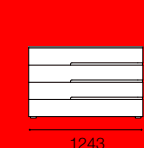

P. | D. _ 432

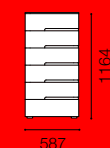

Scocca _ CE Limo
Body _ CE Limo

Frontale _ CE Limo
Front _ CE Limo

Inserto _ ES Matwood Dark
Insert _ ES Matwood Dark

Pouf _ MONDRIAN RETTANGOLARE CON TAVOLINO

Footstool _ CARAVAGGIO

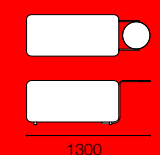

Struttura _ VM Black
Frame _ VM Black

Pouf _ TX Roma 13
Footstool _ TX Roma 13

Piano _ LM Travertino
Top _ LM Travertino

Specchiera _ AFRODITE

Mirror _ AFRODITE

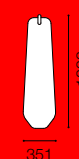

Specchio _ SS Argento
Mirror _ SS Argento





IT_

Nashi è un letto dalle dimensioni apparentemente generose: infatti la testiera abbraccia nella sua forma i comodini occupando in realtà uno spazio complessivo contenuto. La testiera è dotata inoltre di due mensole in legno che si integrano nella struttura e offrono un piano d'appoggio aggiuntivo oltre o in sostituzione al comodino. Sono posizionate ad un'altezza tale che è possibile la sovrapposizione con tutti i comodini in modo da non occupare più spazio del necessario.

EN_

The Nashi bed appears to be particularly spacious with the headboard taking the bedside tables under its wing, while actually occupying a limited amount of space overall. The headboard also has two built-in wooden shelves instead of, or in addition to, the bedside tables, for extra surface space. They sit above the height of any of the bedside tables, without taking up any more space than is necessary.







- 298 -

- 299 -

MAPPA STANZA

Room plan

Location _ 006

Stanza _ I

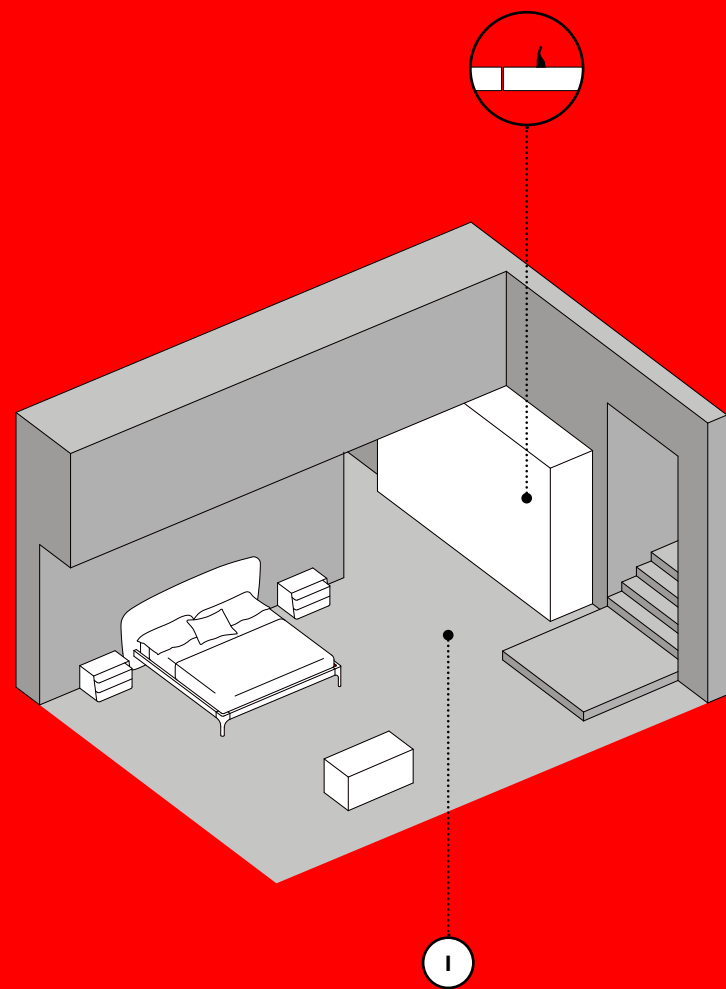

Letto _ DURAN

Bed _ DURAN

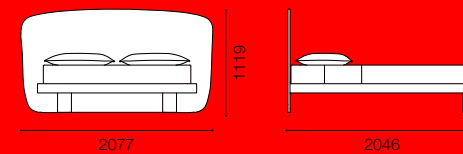

Testiera _ ES Matwood Dark
Headboard _ ES Matwood Dark

Ring _ ES Matwood Dark
Frame _ ES Matwood Dark

Armadio ante battenti _ LISCIA

Hinged-door wardrobe _ LISCIA

P. | D. _ 602

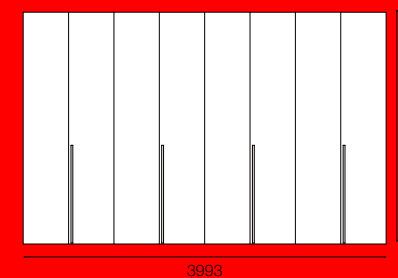

Scocca _ CE Pepe
Body _ CE Pepe

Anta _ CE Pepe
Door _ CE Pepe

Maniglia _ VM Titanio
Handle _ VM Titanio

Collezione _ QUARZO

Collection _ QUARZO

P. | D. _ 418



P. | D. _ 505

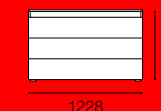

Scocca _ CE Pepe
Body _ CE Pepe

Frontale _ CE Pepe
Front _ CE Pepe

Top _ EX Paris 750
Top _ EX Paris 750

I Stanza I _ Letto DURAN _ Armadio ante battenti LISCIA _ Collezione QUARZO
Room I _ DURAN bed _ LISCIA hinged-door wardrobe _ QUARZO collection

Mood materico
Textured moods







IT_

L'armadio con anta Liscia si adatta ad essere declinato in più stili e varianti grazie alla caratterizzazione della maniglia che in questo caso impreziosisce la semplicità che contraddistingue l'anta stessa.

EN_

This wardrobe featuring the Liscia door can be adapted to suit different styles and variations thanks to the handle concept. Here, it adds a decorative feature to the simple door design.





IT_

Quarzo è un gruppo letto che si distingue per le forme morbide dei frontali, stoncati alle estremità, e per un vano a giorno integrato nella scocca sopra ai cassetti contenitivi. Il piano d'appoggio del vano a giorno può essere caratterizzato da un top dedicato in lamina o eco pelle. Questa personalizzazione permette di coordinare il gruppo ad altri elementi della camera come ad esempio con la testiera del letto parlando di ecopelle o con complementi trasversali trattandosi di lamina.

EN_

Quarzo is a bedroom range which features softly shaped fronts and rounded corners, and an open compartment built into the unit body above the storage drawers. The surface of the open compartment has a special top finish in lamina or eco-leather. By customising the finish, you can coordinate the unit with the rest of the furniture in the room such as the headboard (eco-leather) or versatile accessories and furnishings (lamina).

AREA

TECNICA

IT_

La sezione successiva riporta tutti i dati tecnici inerenti alle categorie di prodotto che sono state esplicate all'interno del catalogo. Secondo quest'ordine sarà possibile trovare: Riepilogo Letti, Riepilogo Armadi, Riepilogo Attrezzature Interne, Riepilogo Collezioni & Sistemi e Riepilogo Complementi. Per maggiori informazioni sui vari prodotti consultare il listino.

EN_

This section provides you with the technical product information for the categories included in this catalogue. Here you can find summaries of the beds, wardrobes, internal fittings, ranges and accessories in that order. For more information on the various products, please see the price list.

1

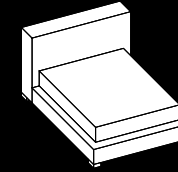

001_
Riepilogo
Letti

001_
Summary
Beds

2

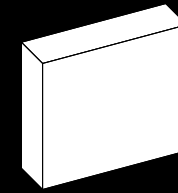

002_
Riepilogo
Armadi

002_
Summary
Wardrobes

3

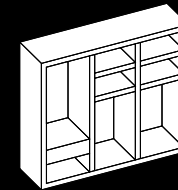

003_
Riepilogo
Attrezzatura
Interna

003_
Summary
Internal
fittings

4

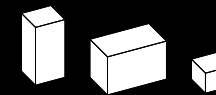

004_
Riepilogo
Collezioni &
Sistemi

004_
Summary
Ranges

5

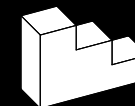

005_
Riepilogo
Complementi

005_
Summary
Accessories

Summary Beds

001_

RIEPILOGO

LETTI

1

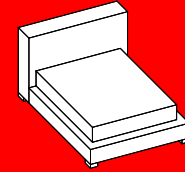

IT_

La collezione dei letti Santalucia Mobili si distingue per l'ampiezza della gamma e per la diversità di caratterizzazioni proposte che si adattano facilmente alle esigenze stilistiche e funzionali dell'utente. La gamma si compone di nove letti in legno, due letti in impiallacciato, otto letti imbottiti e due sistemi letto. Nella maggior parte dei letti sono disponibili più varianti di giroletto e le nuove testiere imbottite si arricchiscono di una rinnovata selezione di tessuti ed ecopelli che offrono numerose possibilità e abbinamenti.

EN_

The Santalucia Mobili bed collection offers a vast range of choices and a diverse array of design features, which can be easily adapted to suit your style and functional needs. The range consists of nine wooden beds, two veneered beds, eight upholstered beds and two bed ranges. Most of the beds are available with a choice of different frames, and there is a revamped selection of fabrics and eco-leathers for the new upholstered headboards, offering numerous options and combinations.

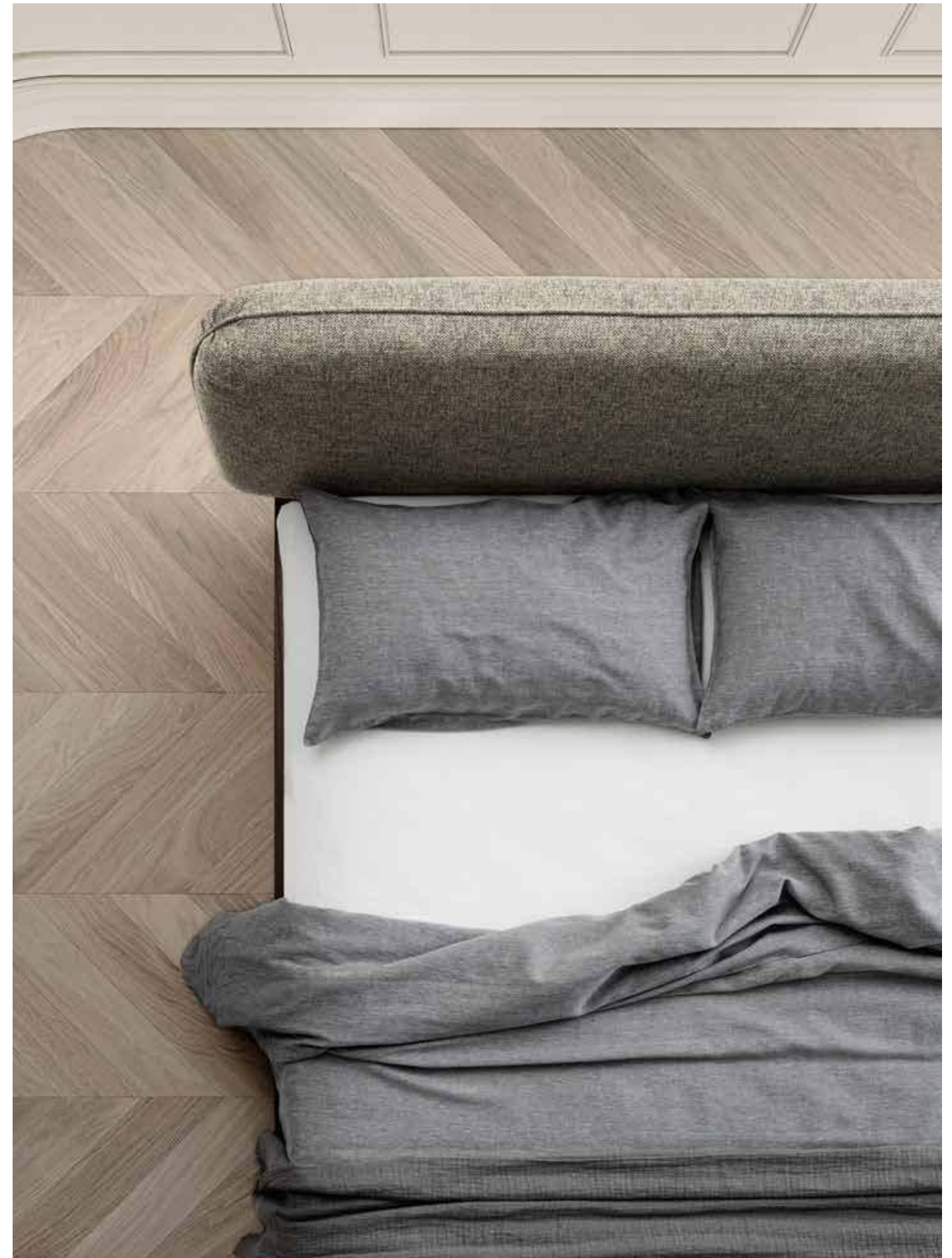

RIEPILOGO LETTI IMBOTTITI

Summary Upholstered beds

Adam_



Giroletto_ Bed frame



Ring Adam
Adam frame

Dimensioni_ Size

L /w	P /d	H /h
2046	2085	960
2465	2135	960

Rivestimento TESTIERA _ HEADBOARD upholstery

(TX) (EX)

Finiture RING _ FRAME finishes

(ES)

Ander_



Giroletto_ Bed frame



Ring Ander
Ander frame

Dimensioni_ Size

L /w	P /d	H /h
1900	2275	985

Rivestimento TESTIERA _ HEADBOARD upholstery

(TX) (EX)

Finiture RING _ FRAME finishes

(ES)

Bali_



Giroletto_ Bed frame



Ring 1
Frame 1

Ring 2
Frame 2

Ring 3
Frame 3

Ring 4
Frame 4

Ring 5
Frame 5

Ring 6
Frame 6

Dimensioni_ Size

L /w	P /d	H /h
2180	2081	1130
2080	2031	1130
2380	2131	1130

Rivestimento TESTIERA _ HEADBOARD upholstery

(TX) (EX)

Finiture RING _ FRAME finishes

(ES) (EH)

RIEPILOGO LETTI IMBOTTITI

Summary Upholstered beds

Ghibli_



Giroletto_ Bed frame



Ring Ghibli
Ghibli frame

Dimensioni_ Size

L /w	P /d	H /h
2030	2090	1200
1930	2140	1200
2230	2190	1200

Rivestimento TESTIERA _ HEADBOARD upholstery

(TX) (EX)

Finiture RING _ FRAME finishes

(TX) (EX)

Ghibli Box_



Giroletto_ Bed frame



Ring Ghibli box
Ghibli Box frame

Dimensioni_ Size

L /w	P /d	H /h
2030	2160	1200
2230	2210	1200

Rivestimento TESTIERA _ HEADBOARD upholstery

(TX) (EX)

Finiture RING _ FRAME finishes

(TX) (EX)

Libeccio_



Giroletto_ Bed frame



Ring Libeccio
Libeccio frame

Dimensioni_ Size

L /w	P /d	H /h
1740	2136	1135
1940	2186	1135

Rivestimento TESTIERA _ HEADBOARD upholstery

(TX) (EX)

Finiture RING _ FRAME finishes

(LO) (ES)

Legenda_ Key

(ES)

Essenza

(EH)

Essenza Light

(IM)

Impiallacciato

(CE)

Colore eco

(LO)

Laccato opaco

(LL)

Laccato lucido

(SC)

Essenza Scult

(SL)

Laccato Opaco Scult

(MT)

Concrete

(LM)

Lamina

(TS)

Tissù

(TR)

Trama

(VM)

Vernici metallizzate

(SS)

Specchi

(VS)

Vetri-Specchi

(TX)

Tessuto

(EX)

Ecopelle

RIEPILOGO LETTI IMBOTTITI

Summary Upholstered beds

Libeccio Soft_



Giroletto_ Bed frame



Ring Libeccio
Libeccio frame

Dimensioni_ Size

L /w	P /d	H /h
1740	2156	1135

1940	2206	1135
------	------	------

Rivestimento TESTIERA _ HEADBOARD upholstery

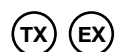

Finiture RING _ FRAME finishes

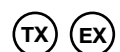

Maistro Imbottito_



Giroletto_ Bed frame



Ring Maistro
Maistro frame

Dimensioni_ Size

L /w	P /d	H /h
2442	2046	1000
1640	2046	1000
2182	2046	1000
2340	1996	1000
2636	2096	1000

Rivestimento TESTIERA _ HEADBOARD upholstery



Finiture RING _ FRAME finishes



Plinio_



Giroletto_ Bed frame



Ring Plinio
Plinio frame

Dimensioni_ Size

L /w	P /d	H /h
1726	2196	1140

1326	2196	1140
------	------	------

1926	2246	1140
------	------	------

Rivestimento TESTIERA _ HEADBOARD upholstery



Finiture RING _ FRAME finishes

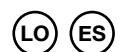

Legenda_ Key



Essenza



Essenza Light



Impiallacciato



Colore eco



Laccato opaco



Laccato lucido



Essenza Scult



Laccato Opaco Scult



Concrete



Lamina



Tissù



Trama



Vernici metallizzate



Specchi



Vetri-Specchi



Tessuto



Ecopelle

RIEPILOGO LETTI IMBOTTITI

Summary Upholstered beds

Scirocco_



Giroletto_ Bed frame



Ring 1
Frame 1



Ring 2
Frame 2

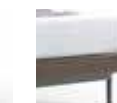

Ring 3
Frame 3



Ring 4
Frame 4



Ring 5
Frame 5



Ring 6
Frame 6

Dimensioni_ Size

L /w	P /d	H /h
1934	2086	1050

1534	2086	1050
------	------	------

1834	2036	1050
------	------	------

2134	2136	1050
------	------	------

Rivestimento TESTIERA _ HEADBOARD upholstery



Finiture RING _ FRAME finishes



RIEPILOGO LETTI SISTEMA

Summary Bed ranges

Testiera Zefiro_



Approfondimento modularità a listino
For modular units, see price list

Sommier abbinabili_ Compatible divan beds



Dimensioni_ Size

L /w	P /d	H /h
500	80	750/1000
1000	80	1000
2000	80	750/1000
2500	80	750/1000
3000	80	750/1000

Finiture TESTIERA _ HEADBOARD finishes

(ES) | (TX) (EX)

Finiture RING _ FRAME finishes

(ES)

Testiera Zefiro con tasche_



Approfondimento modularità a listino
For modular units, see price list

Sommier abbinabili_ Compatible divan beds



Dimensioni_ Size

L /w	P /d	H /h
2500	80	750
3000	80	750

Finiture TESTIERA _ HEADBOARD finishes

(TX) (EX)

Finiture RING _ FRAME finishes

(ES)

Sistema Scacco_



Giroletto_ Bed frame



Approfondimento Sistema Scacco per modularità, misure e accessori a listino.

For Scacco range modular units, sizes and accessories, see price list.

Finiture TESTIERA _ HEADBOARD finishes

(TX) (EX) | (IM) | (LO) (CE) (ES) (EH)

Finiture RING _ FRAME finishes

(TX) (EX) | (LO) (CE) (ES) (EH)

Legenda_ Key

(ES)

Essenza

(EH)

Essenza Light

(IM)

Impiallacciato

(CE)

Colore eco

(LO)

Laccato opaco

(LL)

Laccato lucido

(SC)

Essenza Scult

(SL)

Laccato Opaco Scult

(MT)

Concrete

(LM)

Lamina

(TS)

Tissù

(TR)

Trama

(VM)

Vernici metallizzate

(SS)

Specchi

(VS)

Vetri-Specchi

(TX)

Tessuto

(EX)

Ecopelle

RIEPILOGO LETTI IMPIALLACCIATI

Summary Veneered beds

Talak_



Giroletto_ Bed frame



Ring Talak
Talak frame

Dimensioni_ Size

L /w	P /d	H /h
1785	2205	1100

Testiera_ Headboard



Con Cuscini
With cushions

Senza Cuscini
No cushions

Rivestimento TESTIERA _ HEADBOARD upholstery

(IM) | (TX) (EX)

Finiture RING _ FRAME finishes

(IM)

Espero_



Giroletto_ Bed frame



Ring Espero
Espero frame

Dimensioni_ Size

L /w	P /d	H /h
1716	2112	1155

Testiera_ Headboard



Cuscini Wind
Wind cushions

Cuscini Cling
Cling cushions

Senza Cuscini
No cushions

Rivestimento TESTIERA _ HEADBOARD upholstery

(IM) | (TX) (EX)

Finiture RING _ FRAME finishes

(IM)

RIEPILOGO LETTI

Summary Beds

Duran_



Giroletto_ Bed frame



Ring 1 Frame 1 **Ring 2** Frame 2 **Ring 3** Frame 3 **Ring 4** Frame 4 **Ring 5** Frame 5

Dimensioni_ Size

L /w	P /d	H /h
2077	2046	1119
1377	2046	1119
1677	2046	1119
1977	1996	1119
2277	2096	1119

Finiture TESTIERA _ HEADBOARD finishes

ES EH

Finiture RING _ FRAME finishes

ES EH

Grecale_



Giroletto_ Bed frame



Ring 1 Frame 1 **Ring 2** Frame 2 **Ring 3** Frame 3 **Ring 4** Frame 4 **Ring 5** Frame 5

Dimensioni_ Size

L /w	P /d	H /h
1840	2141	959

Finiture TESTIERA _ HEADBOARD finishes

ES

Finiture RING _ FRAME finishes

ES

Levante_



Giroletto_ Bed frame



Ring 1 Frame 1 **Ring 2** Frame 2 **Ring 3** Frame 3 **Ring 4** Frame 4 **Ring 5** Frame 5

Dimensioni_ Size

L /w	P /d	H /h
1830	2151	1000
1130	2151	1000
1430	2151	1000

Finiture TESTIERA _ HEADBOARD finishes

LO CE ES EH

Finiture RING _ FRAME finishes

LO CE ES EH

RIEPILOGO LETTI

Summary Beds

Lotus



Giroletto_ Bed frame



Ring 1 Frame 1 **Ring 2** Frame 2 **Ring 3** Frame 3 **Ring 4** Frame 4 **Ring 5** Frame 5

Dimensioni_ Size

L /w	P /d	H /h
1733	2193	1050

Finiture TESTIERA _ HEADBOARD finishes

ES

Finiture RING _ FRAME finishes

ES

Maistro_



Giroletto_ Bed frame



Ring 1 Frame 1 **Ring 2** Frame 2 **Ring 3** Frame 3 **Ring 4** Frame 4 **Ring 5** Frame 5

Dimensioni_ Size

L /w	P /d	H /h
2440	2046	1000
1640	2046	1000
2182	2046	1000
2340	1996	1000
2636	2096	1000

Finiture TESTIERA _ HEADBOARD finishes

TX EX | SL SC | LO CE ES EH

Finiture RING _ FRAME finishes

LO CE ES EH

Nashi_



Giroletto_ Bed frame



Ring 1 Frame 1 **Ring 2** Frame 2 **Ring 3** Frame 3 **Ring 4** Frame 4 **Ring 5** Frame 5

Dimensioni_ Size

L /w	P /d	H /h
2480	2043	1126
1780	2043	1126
2080	2043	1126
2380	1993	1126
2680	2093	1126

Finiture TESTIERA _ HEADBOARD finishes

ES EH

Finiture RING _ FRAME finishes

ES EH

Legenda_ Key



Essenza



Essenza Light



Impiallacciato



Colore eco



Laccato opaco



Laccato lucido



Essenza Scult



Laccato Opaco Scult



Concrete



Lamina



Tissù



Trama



Vernici metallizzate



Specchi



Vetri-Specchi



Tessuto



Ecopelle

RIEPILOGO LETTI

Summary Beds

Parentesi_



Giroletto_ Bed frame



Ring 1 Frame 1 Ring 2 Frame 2 Ring 3 Frame 3 Ring 4 Frame 4 Ring 5 Frame 5 Imbottita Upholstered Standard Standard

Dimensioni_ Size

L /w	P /d	H /h
1733	2158	1050
1033	2158	1050
1333	2108	1050
1633	2058	1050

Testiera_ Headboard

Finiture TESTIERA_ HEADBOARD finishes

(TX) (EX) | (LO) (CE) (ES)

Finiture RING_ FRAME finishes

(LO) (CE) (ES)

Tod_



Giroletto_ Bed frame



Ring 1 Frame 1 Ring 2 Frame 2 Ring 3 Frame 3 Ring 4 Frame 4 Ring 5 Frame 5

Dimensioni_ Size

L /w	P /d	H /h
1733	2166	1005

Finiture TESTIERA_ HEADBOARD finishes

(ES)

Finiture RING_ FRAME finishes

(ES)

Wave_



Giroletto_ Bed frame



Ring 1 Frame 1 Ring 2 Frame 2 Ring 3 Frame 3 Ring 4 Frame 4 Ring 5 Frame 5

Dimensioni_ Size

L /w	P /d	H /h
1733	2171	959

Finiture TESTIERA_ HEADBOARD finishes

(ES)

Finiture RING_ FRAME finishes

(ES)

Legenda_ Key



Essenza



Essenza Light



Impiallacciato



Colore eco



Laccato opaco



Laccato lucido



Essenza Scult



Laccato Opaco Scult



Concrete



Lamina



Tissù



Trama



Vernici metallizzate



Specchi



Vetri-Specchi



Tessuto



Ecopelle

APPROFONDIMENTO RING CONTENITIVI

Storage beds

Ring 5_ Box



(ES) (EH) (CE) (LO)

Meccanismo Alzarete Classic con fondi

Classic bed-lift mechanism with bottoms

Disponibili sui Ring 5 (Box) e Ring 6 (Box Imbottito)
Available on Frame 5 (Box) and Frame 6 (Upholstered box)

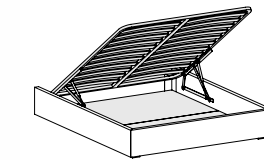

RETE

Bed Base

1600 x 1950

1200 x 1950

1800 x 2000

Ring 6_ Box Imbottito



(TX) (EX)

Meccanismo Alzarete Pratic con fondi

Pratic bed-lift mechanism with bottoms

Disponibili sui Ring 5 (Box) e Ring 6 (Box Imbottito)
Available on Frame 5 (Box) and Frame 6 (Upholstered box)

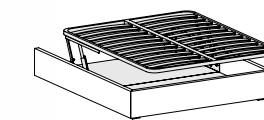

RETE

Bed Base

1600 x 1950

1200 x 1950

1800 x 2000

002_

RIEPILOGO

ARMADI

2

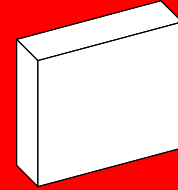

IT_

La collezione degli armadi Santalucia si fonda su principi di concretezza e sobrietà stilistica. Un elemento distintivo è la possibilità di coordinare l'armadio agli altri elementi della zona notte tramite finiture trasversali e segni formali coerenti. Molti dei modelli proposti hanno la peculiarità di presentare la stessa estetica sia nella versione ad anta scorrevole che in quella ad anta battente; questa caratteristica permette di potere scegliere con più libertà l'estetica dell'oggetto senza essere vincolati alla tipologia d'anta. Inoltre risponde al desiderio di avere un segno comune pur con esigenze funzionali diverse dipese dagli spazi domestici.

EN_

The Santalucia wardrobe collection has been created to offer subtle, practical style. One of the collection's distinctive features is the option to coordinate your wardrobe with other units in the bedroom, using versatile finishes and shared features. Many of the models have the same aesthetic finish, whether they have sliding or hinged doors. This means that you can choose the look you want without being limited to a specific type of door. It also creates a common thread, despite the different functional needs dictated by the spaces in your home.



RIEPILOGO ANTE SCORREVOLI

Summary Sliding-door wardrobes

Boleana_



MODULARITÀ Anta_ MODULAR doors

Altezza Height	Larghezza modulo Unit width			
	729	883	967	1337
2402		●	●	●
2530		●	●	●
2850				

Finiture SCOCCA BODY finishes

ES CE LO LL

Finiture ANTE DOOR finishes

ES CE LO LL

Finiture INSERTO INSERT finishes

ES CE LO LL

Double Scorrevole_



MODULARITÀ Anta_ MODULAR doors

Altezza Height	Larghezza modulo Unit width			
	729	883	967	1337
2402		●	●	
2530		●	●	
2850				

Finiture SCOCCA BODY finishes

ES CE LO LL

Finiture ANTE DOOR finishes

ES CE LO LL

Finiture MANIGLIONE HANDLE finishes

ES CE LO IM
MT EX

Ego Scorrevole_



MODULARITÀ Anta_ MODULAR doors

Altezza Height	Larghezza modulo Unit width			
	729	883	967	1337
2402	●	●	●	●
2530	●	●	●	●
2850		●	●	

Finiture SCOCCA BODY finishes

ES EH CE LO
LL

Finiture ANTE DOOR finishes

ES EH CE LO
LL

Finiture MANIGLIONE HANDLE finishes

LO VM

RIEPILOGO ANTE SCORREVOLI

Summary Sliding-door wardrobes

Fascia Scorrevole_



MODULARITÀ Anta_ MODULAR doors

Altezza Height	Larghezza modulo Unit width			
	729	883	967	1337
2402		●	●	●
2530		●	●	●
2850				

Finiture SCOCCA BODY finishes

ES CE LO LL

Finiture ANTE DOOR finishes

ES CE LO LL

Finiture FASCIA INSERT finishes

LL LO CE ES
IM MT SC SL
TR

Inserto_



MODULARITÀ Anta_ MODULAR doors

Altezza Height	Larghezza modulo Unit width			
	729	883	967	1337
2402		●	●	●
2530		●	●	●
2850				

Finiture SCOCCA BODY finishes

ES CE LO LL

Finiture ANTE DOOR finishes

ES CE LO LL

Finiture INSERTO INSERT finishes

ES CE LO LL

Liscia Scorrevole_



MODULARITÀ Anta_ MODULAR doors

Altezza Height	Larghezza modulo Unit width			
	729	883	967	1337
2402	●	●	●	●
2530	●	●	●	●
2850		●	●	

Finiture SCOCCA BODY finishes

ES EH CE LO
LL

Finiture ANTE DOOR finishes

ES EH CE LO
LL TS

Finiture MANIGLIONE HANDLE finishes

ES CE LO

Legenda_ Key

ES Essenza EH Essenza Light IM Impiallacciato CE Colore eco LO Laccato opaco LL Laccato lucido SC Essenza Scult SL Laccato Opaco Scult MT Concrete

LM Lamina TS Tissù TR Trama VM Vernici metallizzate SS Specchi VS Vetri-Specchi TX Tessuto EX Ecopelle

RIEPILOGO ANTE SCORREVOLI

Summary Sliding-door wardrobes

Master Scorrevole_



MODULARITÀ Anta_ MODULAR doors

Altezza Height	Larghezza modulo Unit width			
	729	883	967	1337
2402		●	●	●
2530		●	●	●
2850				

Finiture SCOCCA
BODY finishes



Finiture ANTE
DOOR finishes



Finiture MANIGLIONE
HANDLE finishes



Mod_



MODULARITÀ Anta_ MODULAR doors

Altezza Height	Larghezza modulo Unit width			
	729	883	967	1337
2402	●	●	●	●
2530	●	●	●	●
2850				

Finiture SCOCCA
BODY finishes



Finiture ANTE
DOOR finishes



Finiture FASCIA
INSERT finishes



Nuit_



MODULARITÀ Anta_ MODULAR doors

Altezza Height	Larghezza modulo Unit width			
	729	883	967	1337
2402				
2530			●	●
2850				

Finiture SCOCCA
BODY finishes



Finiture ANTE
DOOR finishes



Finiture MANIGLIONE
HANDLE finishes



Approfondimento listino
For further information, see price list

Legenda_ Key



RIEPILOGO ANTE SCORREVOLI

Summary Sliding-door wardrobes

Piana Scorrevole_



MODULARITÀ Anta_ MODULAR doors

Altezza Height	Larghezza modulo Unit width			
	729	883	967	1337
2402		●	●	●
2530		●	●	●
2850				

Finiture SCOCCA
BODY finishes



Finiture ANTE
DOOR finishes



Profilo_



MODULARITÀ Anta_ MODULAR doors

Altezza Height	Larghezza modulo Unit width			
	729	883	967	1337
2402	●	●	●	●
2530	●	●	●	●
2850				

Finiture SCOCCA
BODY finishes



Finiture ANTE
DOOR finishes



Finiture MANIGLIONE
HANDLE finishes



RIEPILOGO ANTE BATTENTI

Summary Hinged-door wardrobes

Darsena_



MODULARITÀ Anta_ MODULAR doors

Altezza Height	Larghezza modulo Unit width						Terminale End unit	Angolo Corner
	429	471	579	883	967	1183		
2402	●	●	●	●	●	●	●	●
2530	●	●	●	●	●	●	●	●
2850								

Finiture SCOCCA BODY finishes

(ES) (CE) (LO) (LL)

Finiture ANTE DOOR finishes

(ES) (CE) (LO) (LL)

Finiture MANIGLIONE HANDLE finishes

(ES) (CE) (LO)

Double Battente_



MODULARITÀ Anta_ MODULAR doors

Altezza Height	Larghezza modulo Unit width						Terminale End unit	Angolo Corner
	429	471	579	883	967	1183		
2402	●	●	●	●	●	●	●	●
2530	●	●	●	●	●	●	●	●
2850								

Finiture SCOCCA BODY finishes

(ES) (CE) (LO) (LL)

Finiture ANTE DOOR finishes

(ES) (CE) (LO) (LL)

Finiture MANIGLIONE HANDLE finishes

(ES) (CE) (LO) (IM)
(MT) (EX)

Esteta_



MODULARITÀ Anta_ MODULAR doors

Altezza Height	Larghezza modulo Unit width						Terminale End unit	Angolo Corner
	429	471	579	883	967	1183		
2402	●	●		●	●			
2530	●	●		●	●			
2850								

Finiture SCOCCA BODY finishes

(ES) (CE) (LO)

Finiture ANTE DOOR finishes

(ES) (CE) (LO)

Finiture INSERTO INSERT finishes

(EX)

Legenda_ Key

(ES) Essenza (EH) Essenza Light (IM) Impiallacciato (CE) Colore eco (LO) Laccato opaco (LL) Laccato lucido (SC) Essenza Scult (SL) Laccato Opaco Scult (MT) Concrete

RIEPILOGO ANTE BATTENTI

Summary Hinged-door wardrobes

Ego Battente_



MODULARITÀ Anta_ MODULAR doors

Altezza Height	Larghezza modulo Unit width						Terminale End unit	Angolo Corner
	429	471	579	883	967	1183		
2402	●	●	●	●	●	●	●	●
2530	●	●	●	●	●	●	●	●
2850	●	●	●	●	●	●	●	●

Finiture SCOCCA BODY finishes

(ES) (EH) (CE) (LO)
(LL)

Finiture ANTE DOOR finishes

(ES) (EH) (CE) (LO)
(LL) (IM)

Finiture MANIGLIONE HANDLE finishes

(LO) (VM)

Fascia Battente_



MODULARITÀ Anta_ MODULAR doors

Altezza Height	Larghezza modulo Unit width						Terminale End unit	Angolo Corner
	429	471	579	883	967	1183		
2402	●	●	●	●	●	●	●	●
2530	●	●	●	●	●	●	●	●
2850								

Finiture SCOCCA BODY finishes

(ES) (EH) (CE) (LO)
(LL)

Finiture ANTE DOOR finishes

(ES) (EH) (CE) (LO)
(LL)

Finiture FASCIA INSERT finishes

(ES) (EH) (CE) (LO)
(LL) (IM) (MT)

Liscia Battente_



MODULARITÀ Anta_ MODULAR doors

Altezza Height	Larghezza modulo Unit width						Terminale End unit	Angolo Corner
	429	471	579	883	967	1183		
2402	●	●	●	●	●	●	●	●
2530	●	●	●	●	●	●	●	●
2850	●	●	●	●	●	●	●	●

Finiture SCOCCA BODY finishes

(ES) (EH) (CE) (LO)
(LL)

Finiture ANTE DOOR finishes

(ES) (EH) (CE) (LO)
(LL) (IM)

(LM) Lamina (TS) Tessù (TR) Trama (VM) Vernici metallizzate (SS) Specchi (VS) Vetri-Specchi (TX) Tessuto (EX) Ecopelle

RIEPILOGO ANTE BATTENTI

Summary Hinged-door wardrobes

Master Battente_



MODULARITÀ Anta_ MODULAR doors

Altezza Height	Larghezza modulo Unit width						Terminale End unit	Angolo Corner
	429	471	579	883	967	1183		
2402	●	●	●	●	●	●	●	●
2530	●	●	●	●	●	●	●	●
2850								

Finiture SCOCCA BODY finishes

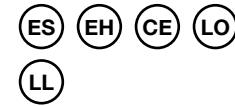

Finiture ANTE DOOR finishes

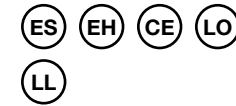

Finiture MANIGLIA HANDLE finishes



Metal_



MODULARITÀ Anta_ MODULAR doors

Altezza Height	Larghezza modulo Unit width						Terminale End unit	Angolo Corner
	429	471	579	883	967	1183		
2402	●	●	●	●	●	●	●	●
2530	●	●	●	●	●	●	●	●
2850								

Finiture SCOCCA BODY finishes

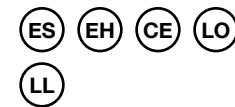

Finiture ANTE DOOR finishes

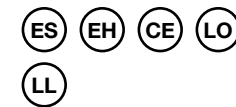

Finiture MANIGLIONE HANDLE finishes



Nocta_



MODULARITÀ Anta_ MODULAR doors

Altezza Height	Larghezza modulo Unit width						Terminale End unit	Angolo Corner
	429	471	579	883	967	1183		
2402								
2530		●			●			
2850								

Finiture SCOCCA BODY finishes



Finiture ANTE DOOR finishes

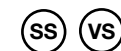

Finiture TELAIO ANTE DOOR FRAME finishes



RIEPILOGO ANTE BATTENTI

Summary Hinged-door wardrobes

Tandem_



MODULARITÀ Anta_ MODULAR doors

Altezza Height	Larghezza modulo Unit width						Terminale End unit	Angolo Corner
	429	471	579	883	967	1183		
2402	●	●		●	●		●	●
2530	●	●		●	●		●	●
2850								

Finiture SCOCCA BODY finishes

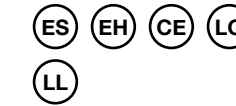

Finiture ANTE DOOR finishes

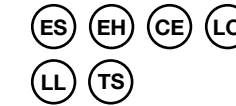

Finiture MANIGLIONE HANDLE finishes

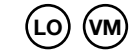

Twin_



MODULARITÀ Anta_ MODULAR doors

Altezza Height	Larghezza modulo Unit width						Terminale End unit	Angolo Corner
	429	471	579	883	967	1183		
2402	●	●	●	●	●	●	●	●
2530	●	●	●	●	●	●	●	●
2850								

Finiture SCOCCA BODY finishes



Finiture ANTE DOOR finishes



Finiture MANIGLIONE HANDLE finishes



Luxury_



MODULARITÀ Anta_ MODULAR doors

Altezza Height	Larghezza modulo Unit width						Terminale End unit	Angolo Corner
	429	471	579	883	967	1183		
2402								
2530		●			●			
2850								

Finiture SCOCCA BODY finishes

Matwood Dark

Finiture ANTE DOOR finishes

Vetro Stopsol

Finiture TELAIO ANTE DOOR FRAME finishes

Titanio

Legenda_ Key



Summary Internal fittings

003_

RIEPILOGO

ATTREZZATURA INTERNA

3

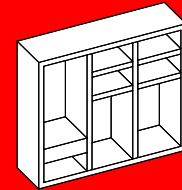

IT_

L'attrezzatura interna degli armadi è composta da diversi elementi con la scopo di organizzare razionalmente lo spazio interno all'armadio e allo stesso tempo conferire all'armadio una valenza estetica. Elementi contenitivi e scaffali sono disponibili in due finiture. Scarpiere, ripiani estraibili in vetro, reggipantaloni estraibili ed altre attrezzature sono realizzate con un elegante finitura metallica brunita. A completamento dell'attrezzatura interna vengono proposte diversi tipi di scatole divisorie e contenitive, grucce e altri accessori funzionali.

EN_

The internal wardrobe fittings consist of different elements to rationally organise the available wardrobe space, while also adding aesthetic value. The storage units and shelves come in two finishes. Shoe racks, pull-out glass shelves, pull-out trouser racks and other fittings all come in an elegant burnished-metal finish. To complete the design, there are various types of partition storage boxes, hangers and other functional accessories to choose from.



RIEPILOGO ATTREZZATURA INTERNA

Summary Internal fittings

Tramezza_
Wardrobes Partitions



Cassettiera_
Drawer Unit



Ripiano Legno Sp.35_
Thk. 35 Wooden Shelf



Ripiano Telaio Vetro_
Glass Frame Shelf



Tubo Appendiabiti_
Clothes Rail



Appendiabiti Servetto_
Pull-down Rail



Tappettino per ripiano legno_
Rug for wooden shelf



Vassoio estraibile_
Pull-out Tray



Porta Biancheria estraibile_
Pull-out Laundry Basket



RIEPILOGO ATTREZZATURA INTERNA

Summary Internal fittings

Porta Pantaloni estraibile_
Pull-out Trouser Rack



Porta Cravatte estraibile_
Pull-out Tie Rack



Porta Scarpe estraibile_
Pull-out Shoe Rack



Ripiano porta scarpe_
Shelf for Shoe



Raster_
Raster



Specchi interno armadio_
Internal Mirror



Strip Led_
Strip Led



Led in fresata (fianchi e divisioni)_
Milled Led



334

335

RIEPILOGO ATTREZZATURA INTERNA

Summary Internal fittings

Scatole interno armadio_
Internal Wardrobe Box



Vassoio svuotatasche_
Pocket Emptier



Porta cravatte_
Tie Rack



Divisorio porta anelli_
Ring Holder



Divisorio porta orologi_
Organizer for Watches



Divisorio porta oggetti_
Divider for Objects



Organizer 3 vani porta oggetti_
3 Compartments for Objects Organizer



Sanificatore per interno armadio_
Sanitising System for inside Wardrobe



RIEPILOGO ATTREZZATURA INTERNA BASIC

Summary Internal fittings _ BASIC

Cassettiera - BASIC_
Drawer Unit - BASIC



Vassoio estraibile - BASIC_
Pull-out Tray - BASIC



Porta Cravatte estraibile - BASIC_
Pull-out Shoe Rack - BASIC



Porta Pantaloni estraibile - BASIC_
Pull-out Trousler Rack - BASIC



Porta Cinture estraibile - BASIC_
Pull-out Belt Hanger - BASIC



Porta Scarpe estraibile - BASIC_
Pull-out Shoe Rack - BASIC



Porta Pantaloni (su fianco)_
Trousler Rack (on the side panel)



Porta Grucce_
Hook



Summary Ranges

004_

RIEPILOGO

COLLEZIONI & SISTEMI

4

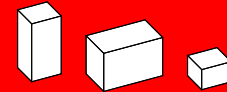

IT_

La panoramica dei gruppi e sistemi in parte già descritta a catalogo, in questa sezione è apprezzabile in tutta la sua completezza. Finiture e materiali sono parte integrante della gamma dal momento che ne ampliano gli attributi estetico-stilistici e quindi la trasversalità. Lo stesso oggetto può riscoprirsi in uno stile classico come contemporaneo semplicemente variandone la finitura, applicando una maniglia o, come per i sistemi, trovando un piedino metallico che lo alzi da terra.

EN_

In this section you can browse all of the ranges described in part throughout this catalogue. The finishes and materials are an integral part, as they add to the aesthetic and stylistic appeal of our ranges and extend their applications. The same piece of furniture can be used to create both classic and contemporary style, simply by changing the finish, adding a handle or raising it off the ground with metal feet.

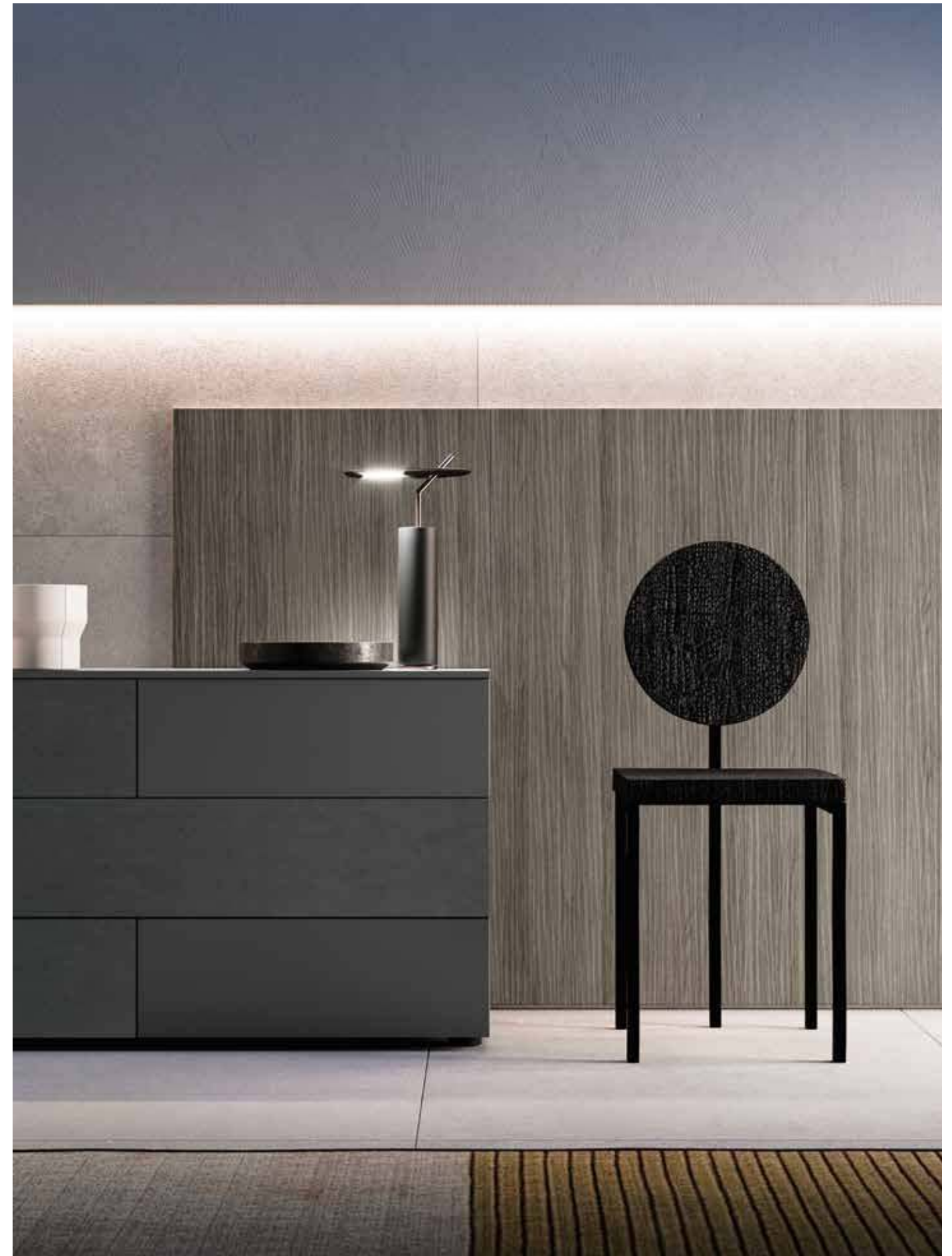

RIEPILOGO COLLEZIONE

Summary Collection

340



Dolomite
Dolomite

Legenda_ Key

- (ES)**
Essenza
- (EH)**
Essenza Light
- (IM)**
Impiallacciato
- (CE)**
Colore eco
- (LO)**
Laccato opaco
- (LL)**
Laccato lucido
- (SC)**
Essenza Scult
- (SL)**
Laccato Opaco Scult
- (MT)**
Concrete

Homy _ Notte

RIEPILOGO COLLEZIONE

Summary Collection

341

(A) **Settimanale**_
Chest of drawers

P. | D. _ 402

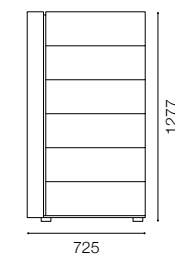

(B) **Comò**_
Dresser

P. | D. _ 489

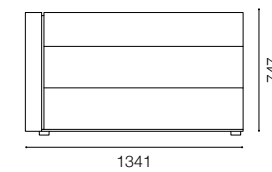

(C) **Comodini**_
Bedside tables

P. | D. _ 402

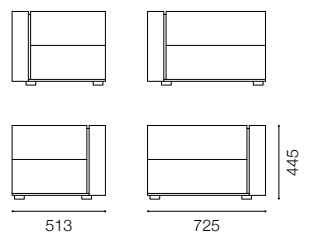

Finiture SCOCCA_ BODY finishes

- (ES)**
- (CE)**
- (LO)**
- (LL)**

Finiture FRONTALI_ FRONT finishes

- (ES)**
- (CE)**
- (LO)**
- (LL)**

Finiture FIANCONE_ LARGE SIDE PANEL finishes

- (ES)**
- (CE)**
- (LO)**
- (LL)**
- (MT)**

- (LM)**
Lamina
- (TS)**
Tissù
- (TR)**
Trama
- (VM)**
Vernici metallizzate
- (SS)**
Specchi
- (VS)**
Vetri-Specchi
- (TX)**
Tessuto
- (EX)**
Ecopelle

Homy _ Notte

RIEPILOGO COLLEZIONE

Summary Collection

342



Opale
Opale

Legenda_ Key



Homy _ Notte

RIEPILOGO COLLEZIONE

Summary Collection

A **Settimanale_**
Chest of drawers

P. | D. _ 432

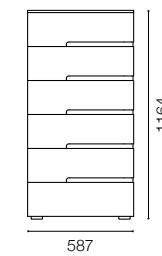

B **Comò_**
Dresser

P. | D. _ 519

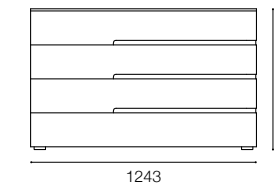

C **Comodini_**
Bedside tables

P. | D. _ 432

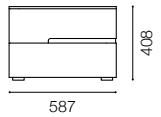

Finiture SCOCCA_ BODY finishes



Finiture FRONTALI_ FRONT finishes



Finiture INSERTO_ INSERT finishes



343

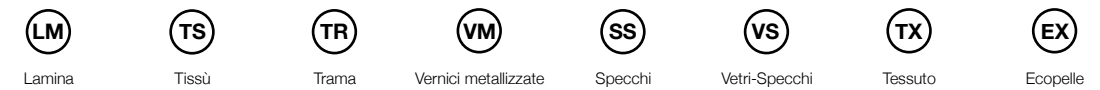

Homy _ Notte

RIEPILOGO COLLEZIONE

Summary Collection

344



Spot
Spot

Legenda_ Key

- (ES)**
Essenza
- (EH)**
Essenza Light
- (IM)**
Impiallacciato
- (CE)**
Colore eco
- (LO)**
Laccato opaco
- (LL)**
Laccato lucido
- (SC)**
Essenza Scult
- (SL)**
Laccato Opaco Scult
- (MT)**
Concrete

RIEPILOGO COLLEZIONE

Summary Collection

(A) **Settimanale_**
Chest of drawers

P. | D. _ 445

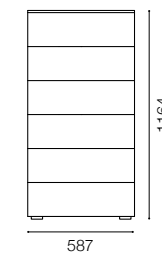

(B) **Comò_**
Dresser

P. | D. _ 540

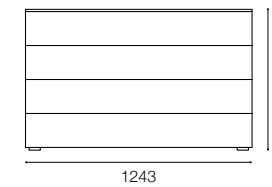

(C) **Comodini_**
Bedside tables

P. | D. _ 445

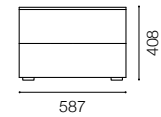

Finiture **SCocca_** BODY finishes

(ES)

Finiture **FRONTALI_** FRONT finishes

(ES)

- (LM)**
Lamina
- (TS)**
Tissù
- (TR)**
Trama
- (VM)**
Vernici metallizzate
- (SS)**
Specchi
- (VS)**
Vetri-Specchi
- (TX)**
Tessuto
- (EX)**
Ecopelle

345

RIEPILOGO COLLEZIONE

Summary Collection

RIEPILOGO COLLEZIONE

Summary Collection

346



A **Settimanale_**
Chest of drawers

B **Comò_**
Dresser

C **Comodini_**
Bedside tables

P. | D. _ 445

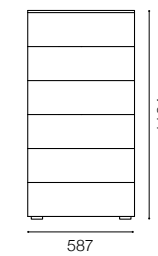

P. | D. _ 540

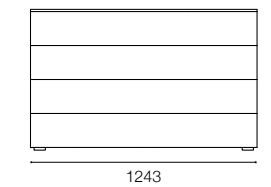

P. | D. _ 445

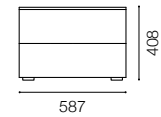

Finiture SCOCCA_ BODY finishes

Finiture FRONTALI_ FRONT finishes

ES

ES

347

Spot Mix
Spot Mix

Legenda_ Key

ES

Essenza

EH

Essenza Light

IM

Impiallacciato

CE

Colore eco

LO

Laccato opaco

LL

Laccato lucido

SC

Essenza Scult

SL

Laccato Opaco Scult

MT

Concrete

LM

Lamina

TS

Tissù

TR

Trama

VM

Vernici metallizzate

SS

Specchi

VS

Vetri-Specchi

TX

Tessuto

EX

Ecopelle

RIEPILOGO COLLEZIONE

Summary Collection

348



RIEPILOGO COLLEZIONE

Summary Collection

A **Settimanale_**
Chest of drawers

B **Comò_**
Dresser

C **Comodini_**
Bedside tables

P. | D. _ 400

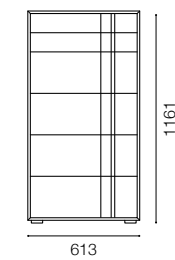

P. | D. _ 500

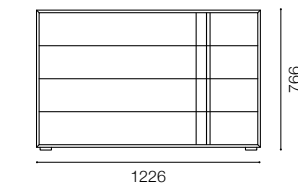

P. | D. _ 400

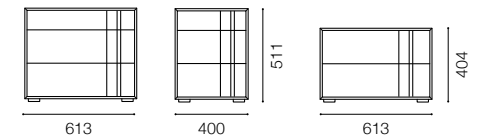

Finiture SCOCCA_ BODY finishes

ES **CE** **LO** **LL**

Finiture FRONTALI_ FRONT finishes

ES **CE** **LO** **LL**

Finiture MANIGLIE_ HANDLE finishes

ES **CE** **LO**

349

Quadro Darsena
Quadro Darsena

Legenda_ Key

ES Essenza **EH** Essenza Light **IM** Impiallacciato **CE** Colore eco **LO** Laccato opaco **LL** Laccato lucido **SC** Essenza Scult **SL** Laccato Opaco Scult **MT** Concrete

LM Lamina **TS** Tissù **TR** Trama **VM** Vernici metallizzate **SS** Specchi **VS** Vetri-Specchi **TX** Tessuto **EX** Ecopelle

Homy _ Notte

Homy _ Notte

RIEPILOGO COLLEZIONE

Summary Collection

350

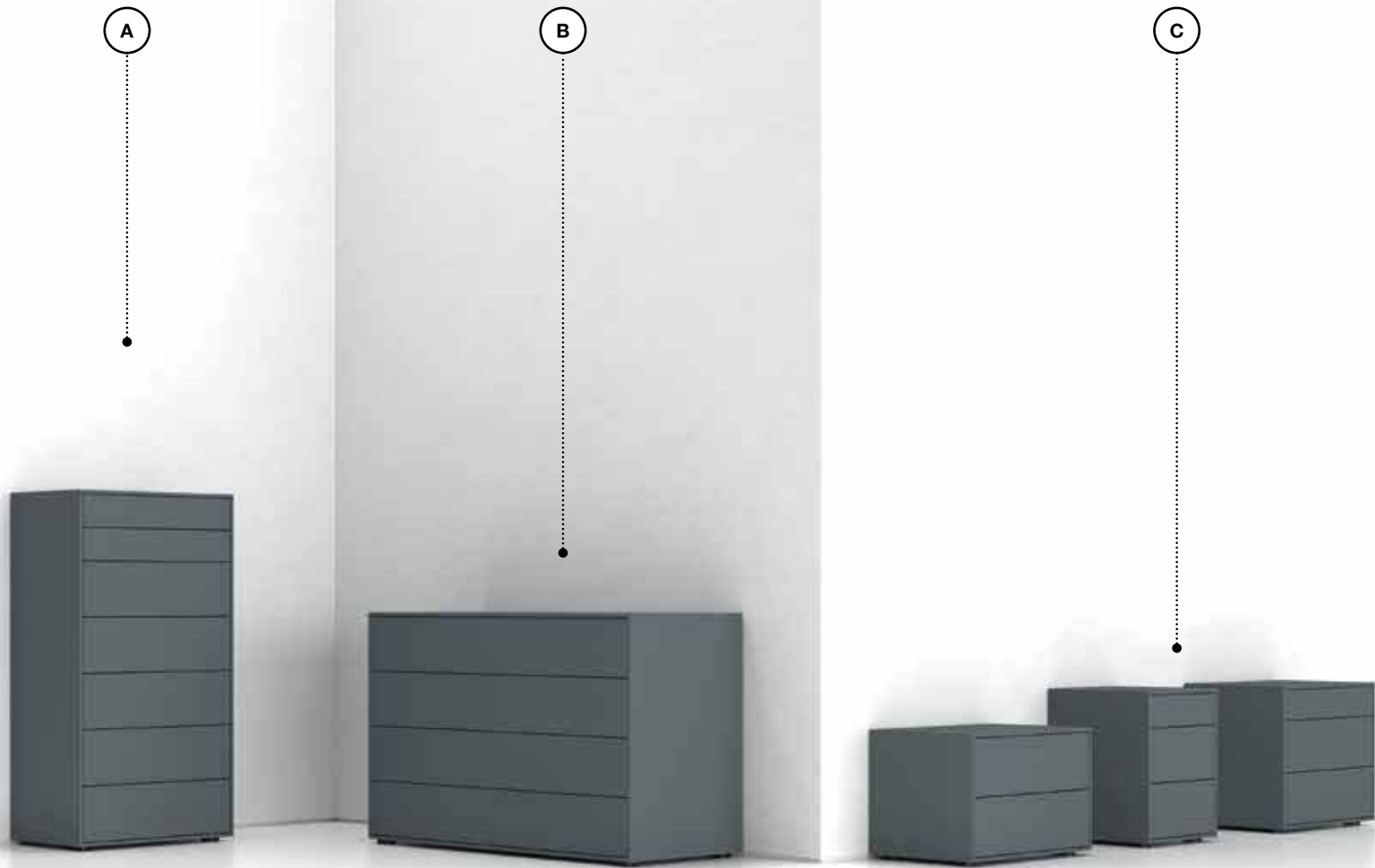

Quadro Filo
Quadro Filo

Legenda_ Key



Homy _ Notte

RIEPILOGO COLLEZIONE

Summary Collection

A **Settimanale_**
Chest of drawers

P. | D. _ 400

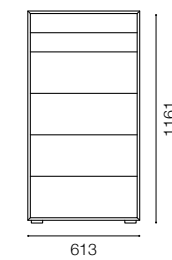

B **Comò_**
Dresser

P. | D. _ 500

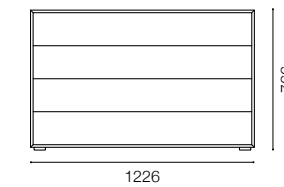

C **Comodini_**
Bedside tables

P. | D. _ 400

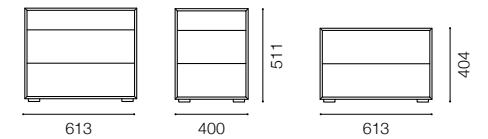

Finiture SCOCCA_ BODY finishes



Finiture FRONTALI_ FRONT finishes

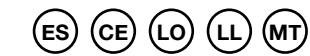

351

Homy _ Notte

RIEPILOGO COLLEZIONE

Summary Collection

352



Quadro 12
Quadro 12

Legenda_ Key



Homy _ Notte

RIEPILOGO COLLEZIONE

Summary Collection

A **Settimanale_**
Chest of drawers

B **Comò_**
Dresser

C **Comodini_**
Bedside tables

P. | D. _ 400

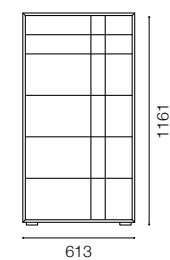

P. | D. _ 500

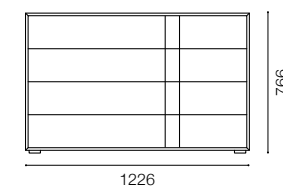

P. | D. _ 400

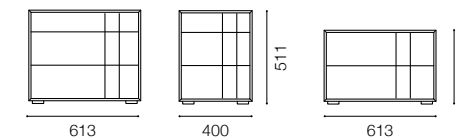

Finiture SCOCCA_ BODY finishes



Finiture FRONTALI_ FRONT finishes



Finiture MANIGLIE_ HANDLE finishes



353

Homy _ Notte

RIEPILOGO COLLEZIONE

Summary Collection

354



Onice
Onice

Legenda_ Key



Homy_ Notte

RIEPILOGO COLLEZIONE

Summary Collection

355

A **Settimanale_**
Chest of drawers

P. | D. _ 498

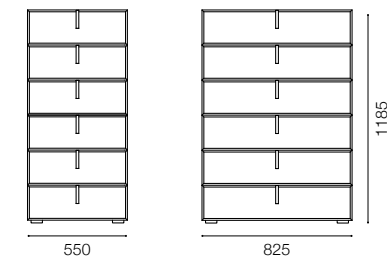

B **Comò_**
Dresser

P. | D. _ 498

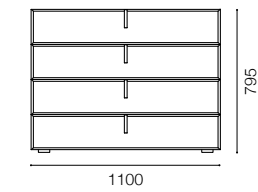

C **Comodini_**
Bedside tables

P. | D. _ 498

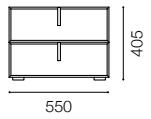

Finiture SCOCCA_ BODY finishes



Finiture FRONTALI_ FRONT finishes

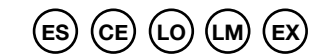

Finiture MANIGLIE_ HANDLE finishes



Homy_ Notte

RIEPILOGO COLLEZIONE

Summary Collection

A

B



— 356 —

Quarzo
Quarzo

Legenda_ Key

ES

Essenza

EH

Essenza Light

IM

Impiallacciato

CE

Colore eco

LO

Laccato opaco

LL

Laccato lucido

SC

Essenza Scult

SL

Laccato Opaco Scult

MT

Concrete

LM

Lamina

TS

Tissù

TR

Trama

VM

Vernici metallizzate

SS

Specchi

VS

Vetri-Specchi

TX

Tessuto

EX

Ecopelle

Homy _ Notte

Homy _ Notte

RIEPILOGO COLLEZIONE

Summary Collection

A Comò_
Dresser

B Comodini_
Bedside tables

P. | D. _ 505

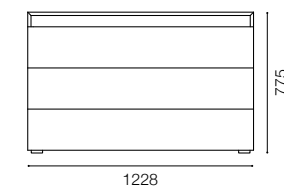

P. | D. _ 418

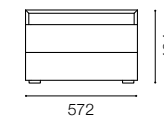

Finiture SCOCCA_ BODY finishes

CE

Finiture FRONTALI_ FRONT finishes

CE

Finiture PIANETTO VANO_ COMPARTMENT SMALL TOP finishes

CE

LM

EX

— 357 —

RIEPILOGO SISTEMI COMPONIBILI

Summary Modular ranges



358

359

SISTEMA COBALTO

Cobalto range

Modularità_ Modular units

Dimensioni Size	550	825	1100	1375	1650	Angolo_Corner
204						
405						
606						
807						
1029						

Finiture SCOCCA_ BODY finishes



Finiture FRONTALI_ FRONT finishes



Basamenti_ Base units



Piedino h.23 di serie
Standard feet H. 23



Staffa Plexi
Plexi bracket



Piedi Corner
Corner feet

Legenda_ Key



RIEPILOGO SISTEMI COMPONIBILI

Summary Modular ranges



SISTEMA DICHIOTTO

Diciotto range

Modularità_ Modular units

Dimensioni Size	460	612	766	919	1225	1378	1531
243							
451							
659							
867							
1283							

Finiture SCOCCA_ BODY finishes



Finiture FRONTALI_ FRONT finishes



Basamenti_ Base units



Piedino h.23 di serie
Standard feet H. 23

Staffa Plexi
Plexi bracket

Piedi Corner
Corner feet

Legenda_ Key



RIEPILOGO SISTEMI COMPONIBILI

Summary Modular ranges



362

363

SISTEMA EGO EGO range

Modularità_ Modular units

Dimensioni Size	460	612	766	919	1225	1378	1531
243							
451							
659							
867							
1283							

Finiture SCOCCA_ BODY finishes

ES EH CE LO LL

Finiture FRONTALI_ FRONT finishes

ES EH IM CE LO LL MT TR

Finiture MANIGLIA_ HANDLE finishes

VM LO

Basamenti_ Base units



Piedino h.23 di serie
Standard feet H. 23

Staffa Plexi
Plexi bracket

Piedi Corner
Corner feet

Legenda_ Key

ES

Essenza

EH

Essenza Light

IM

Impiallacciato

CE

Colore eco

LO

Laccato opaco

LL

Laccato lucido

SC

Essenza Scult

SL

Laccato Opaco Scult

MT

Concrete

LM

Lamina

TS

Tissù

TR

Trama

VM

Vernici metallizzate

SS

Specchi

VS

Vetri-Specchi

TX

Tessuto

EX

Ecopelle

Summary of accessories

005_

RIEPILOGO

COMPLEMENTI

5

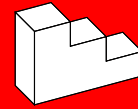

IT_

Questa è l'area della caratterizzazione più raffinata. In questa sezione si potranno trovare elementi d'arredo che rappresentano il "tocco finale" dell'arredo di una stanza. Accessori e complementi concepiti per occupare spazi difficili, spazi contenuti eppure importanti. Questa è la sezione dei dettagli che fanno la differenza. Specchi sagomati esclusivi, tavolini, pouff ed ancora servetti, maniglie e tante finiture caratterizzanti.

EN_

Here you can find our most elegant pieces: furnishings to add that final touch to the interior design of your room, and accessories designed for those tricky spaces that are compact yet vitally important. This is where the details make all the difference: exclusive moulded mirrors, occasional tables, footstools, wardrobe rails, handles and many more distinguishing finishes.



RIEPILOGO COMPLEMENTI

Summary of accessories

MONDRIAN RETTANGOLARE_



Dimensioni _ Size

L. /w H. /h P. /d

950 470 400

Finiture STRUTTURA
FRAME finishes

(VM) _Black

RIVESTIMENTO
Upholstery

(EX) **(TX)**

Finiture ACCESSORI
ACCESSORY finishes

(ES) **(CE)** **(LO)**

(LM) con Tavolino
Occasional table

(EX) con Portariviste
Magazine rack

MONDRIAN QUADRATO_



Dimensioni _ Size

L. /w H. /h P. /d

400 470 400

Finiture STRUTTURA
FRAME finishes

(VM) _Black

RIVESTIMENTO
Upholstery

(EX) **(TX)**

Finiture ACCESSORI
ACCESSORY finishes

(ES) **(CE)** **(LO)**

(LM) con Tavolino
Occasional table

(EX) con Portariviste
Magazine rack

BELLINI_



Dimensioni _ Size

L. /w H. /h P. /d

510 523 510

Finiture STRUTTURA
FRAME finishes

(VM) _Black

RIVESTIMENTO
Upholstery

(EX) **(TX)**

Legenda_ Key

(ES)

Essenza

(EH)

Essenza Light

(IM)

Impiallacciato

(CE)

Colore eco

(LO)

Laccato opaco

(LL)

Laccato lucido

(SC)

Essenza Scult

(SL)

Laccato Opaco Scult

(MT)

Concrete

(LM)

Lamina

(TS)

Tissù

(TR)

Trama

(VM)

Vernici metallizzate

(SS)

Specchi

(VS)

Vetri-Specchi

(TX)

Tessuto

(EX)

Ecopelle

RIEPILOGO COMPLEMENTI

Summary of accessories

MATISSE_



Dimensioni _ Size

L. /w H. /h P. /d

460 1468 599

Finiture STRUTTURA
FRAME finishes

(VM) _Black

RIVESTIMENTO
Upholstery

(EX) **(TX)**

MICHELANGELO_



Dimensioni _ Size

L. /w H. /h P. /d

450 532 450

Finiture STRUTTURA
FRAME finishes

(VM) _Black

Finiture PIANO
TOP finishes

(ES) **(CE)** **(LO)** **(LM)**

LEONARDO_



Dimensioni _ Size

L. /w H. /h P. /d

450 1260 450

Finiture STRUTTURA
FRAME finishes

(VM) _Black

Finiture PIANO
TOP finishes

(ES) **(CE)** **(LO)** **(LM)**

RIEPILOGO COMPLEMENTI

Summary of accessories

GIOTTO_



Dimensioni e finiture
Sizes and finishes

L. H. P. (LO)
/w /h /d

350 450 350

DA VINCI_



Dimensioni e finiture
Sizes and finishes

L. H. P.
/w /h /d

476 468 300

MONET_



Dimensioni e finiture
Sizes and finishes

L. H. P. (LO)
/w /h /d

398 516 398

PICASSO_



Dimensioni e finiture
Sizes and finishes

L. H. P.
/w /h /d

380 476 380

MIRÒ_



Dimensioni e finiture
Sizes and finishes

L. H. P. (LO)
/w /h /d

400 502 400

KLIMT 416_



Dimensioni e finiture
Sizes and finishes

L. H. P. (LO)
/w /h /d

470 416 470

EOLO_



Dimensioni e finiture
Sizes and finishes

L. H. P. (ES) (CE)
/w /h /d

1725 440 400

(EX) (TX)

KLIMT 518_



Dimensioni e finiture
Sizes and finishes

L. H. P. (LO)
/w /h /d

470 518 470

RAFFAELLO_



Dimensioni e finiture
Sizes and finishes

L. H. P. (LO)
/w /h /d

615 415 615

Legenda_ Key

(ES)

Essenza

(EH)

Essenza Light

(IM)

Impiallacciato

(CE)

Colore eco

(LO)

Laccato opaco

(LL)

Laccato lucido

(SC)

Essenza Scult

(SL)

Laccato Opaco Scult

(MT)

Concrete

(LM)

Lamina

(TS)

Tissù

(TR)

Trama

(VM)

Vernici metallizzate

(SS)

Specchi

(VS)

Vetri-Specchi

(TX)

Tessuto

(EX)

Ecopelle

RIEPILOGO COMPLEMENTI

Summary of accessories

AFRODITE 160_



Dimensioni e finiture
Sizes and finishes

L. /w	H. /h	P. /d
474	1633	35

AFRODITE 120_



Dimensioni e finiture
Sizes and finishes

L. /w	H. /h	P. /d
351	1233	35

MEDUSA_



Dimensioni e finiture
Sizes and finishes

L. /w	H. /h	P. /d
420	1201	92

ATENA_



Dimensioni e finiture
Sizes and finishes

L. /w	H. /h	P. /d
513	1800	182

FREJA_



Dimensioni e finiture
Sizes and finishes

L. /w	H. /h	P. /d
350	1400	22

DIANA_



Dimensioni e finiture
Sizes and finishes

L. /w	H. /h	P. /d	LL	LO	CE	ES	EH
413	1794	339					

RIEPILOGO COMPLEMENTI

Summary of accessories

MAIA 180_



Dimensioni e finiture
Sizes and finishes

L. /w	H. /h	P. /d	LL	LO	CE	ES	EH
800	1800	35					

CHIMERA 60_



Dimensioni e finiture
Sizes and finishes

L. /w	H. /h	P. /d	ES	CE
638	638	35		

MAIA 80_



Dimensioni e finiture
Sizes and finishes

L. /w	H. /h	P. /d	LL	LO	CE	ES	EH
800	812	120					

CHIMERA 100_



Dimensioni e finiture
Sizes and finishes

L. /w	H. /h	P. /d	ES	CE
1013	1013	35		

MAIA 120_



Dimensioni e finiture
Sizes and finishes

L. /w	H. /h	P. /d	LL	LO	CE	ES	EH
1200	812	120					

DELFI_



Dimensioni e finiture
Sizes and finishes

L. /w	H. /h	P. /d
1000	640	25

Legenda_ Key



Essenza



Essenza Light



Impiallacciato



Colore eco



Laccato opaco



Laccato lucido



Essenza Scult



Laccato Opaco Scult



Concrete



Lamina



Tissù



Trama



Vernici metallizzate



Specchi



Vetri-Specchi



Tessuto



Ecopelle

RIEPILOGO COMPLEMENTI

Summary of accessories

GIUNONE_



Dimensioni e finiture
Sizes and finishes

L. H. P. LL LO ES
/w /h /d

800 1800 50

TALIA_



Dimensioni e finiture
Sizes and finishes

L. H. P. LL LO ES
/w /h /d

1150 680 50

NINFEA_



Dimensioni e finiture
Sizes and finishes

L. H. P. LL LO ES
/w /h /d

900 900 50

NAUSICA_



Dimensioni e finiture
Sizes and finishes

L. H. P.
/w /h /d

640 960 25

Legenda_ Key

ES

Essenza

EH

Essenza Light

IM

Impiallacciato

CE

Colore eco

LO

Laccato opaco

LL

Laccato lucido

SC

Essenza Scult

SL

Laccato Opaco Scult

MT

Concrete

LM

Lamina

TS

Tissù

TR

Trama

VM

Vernici metallizzate

SS

Specchi

VS

Vetri-Specchi

TX

Tessuto

EX

Ecopelle

RIEPILOGO MANIGLIE

Summary Handles

MNG 240_



MNG 285_



MNG 916_



MNG 532_



MNG 533_



MNG 831_



MNG 534_



MNG 832_



RIEPILOGO MANIGLIE

Summary Handles

MNG 262_



MNG 535_



MNG 530_



MNG 531_

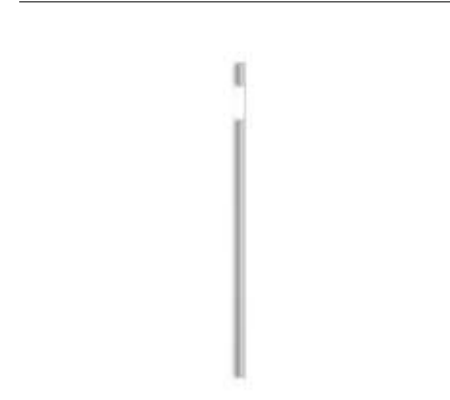

MNG 296_

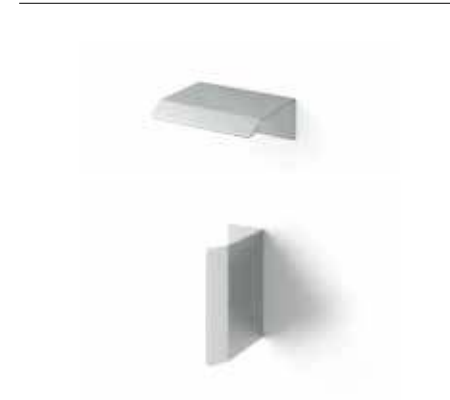

MNG 287_

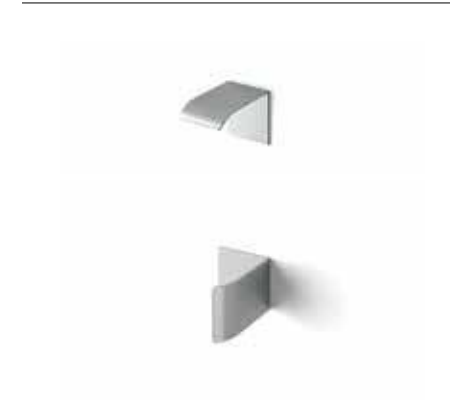

Push pull incassato_

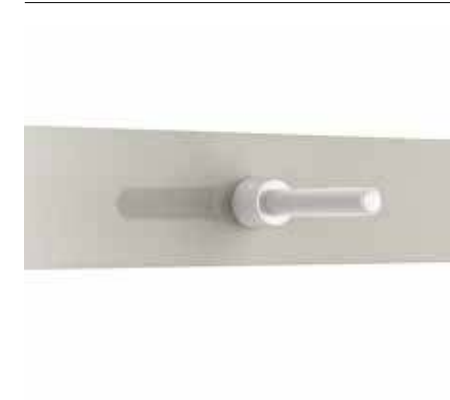

- 374 -

- 375 -

Summary Finishes

006_

RIEPILOGO

FINITURE

IT_

Le molteplici finiture disponibili offrono una vasta gamma di soluzioni stilistiche per configurare come più si preferisce i mobili Santalucia che sono stati scelti. L'area che segue è strutturata per categorie rendendo così agevole la scelta delle finiture.

EN_

The vast array of finishes on offer provide you with a wealth of stylistic solutions to design your chosen Santalucia furniture just how you like it. Below you can find our finishes ordered by category, making them easy to choose from.

RIEPILOGO FINITURE

Summary Finishes

ES **Essenza** Wood grain



matwood white



matwood grey



matwood coffee



matwood dark

EH **Essenza Light** Light wood grain

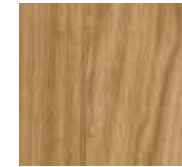

matwood honey

IM **Impiallacciato** Veneer



legno steppa

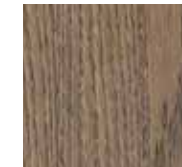

legno tundra

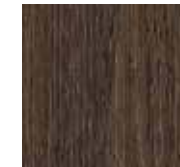

legno giungla

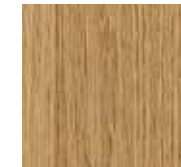

legno savana

CE **Colore Eco** Eco colour

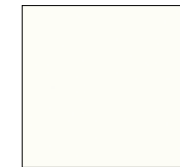

eco bianco



eco limo



eco pepe



eco marna

LO **Laccato Opaco** Matt lacquer

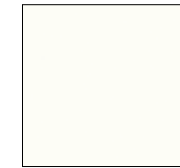

bianco



ghiaia



limo



pepe



cipria



mosto



nevada

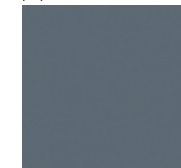

basalto



curry



cuoio



senape



paprica

LL **Laccato Lucido** Glossy lacquer



antimonio



marna



nero



petrolio



maggese



verde ombra

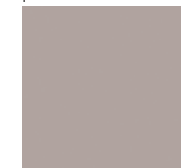

ecrù

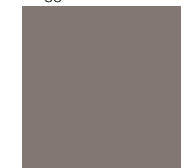

fango



grigio polvere

RIEPILOGO FINITURE

Summary Finishes

SC **Essenza Scult** Scult wood grain



scult white scult grey scult coffee scult dark

SL **Laccato Opaco Scult** Scult matt lacquer



scult bianco scult ghiaia scult limo scult pepe scult antimonio scult marna scult nero



scult cipria scult mosto scult nevada scult basalto scult petrolio scult magnese scult verde ombra

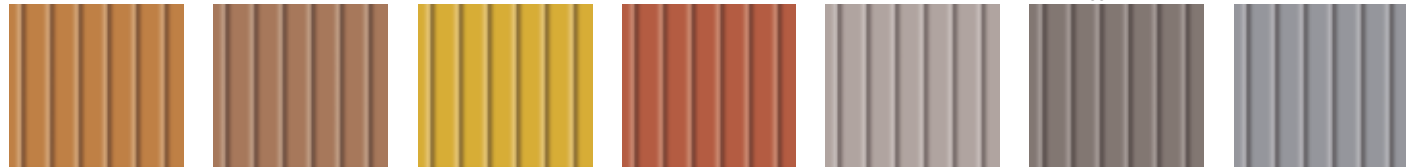

scult curry scult cuoio scult senape scult paprica scult ecrù scult fango scult grigio polvere

MT **Concrete** Concrete



concrete limo concrete pepe concrete marna concrete magnese concrete cuoio concrete petrolio concrete ecrù

LM **Lamina** Lamina



travertino botticino navajo gold piacentino

RIEPILOGO FINITURE

Summary Finishes

TR **Trama** Texture

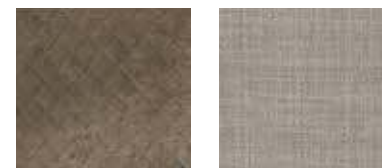

rubik tela

FI **Finitura Interna ANTIBATTERICA*** ANTIBACTERIAL* Interior finish



biancospino fabrik

SS **Specchi** Mirror



specchio argento

TS **Tissù** Tissù



bianco limo

VM **Vernici Metalliche** Metallic paints



bronzo nickel titanio black

VS **Vetri-Specchi** Glasses-Mirrors



vetro bianco vetro stopsol specchio bronzo

* La tecnologia Silver Coat rende le superfici Antibatteriche, Antimicrobiche, Antifungine e Disinfettanti. Queste proprietà sono state certificate dal CATAS.

* Silver Coat technology makes surfaces Antibacterial, Antimicrobial, Antifungal and Disinfectant. These properties have been certified by CATAS laboratory.

member of
ITALIAN**HABIT**

SANTALUCIA MOBILI

Art Direction: Studio Spessotto
Graphic Design: Studio Spessotto
Product Design: Studio Spessotto
Foto: Studio Fotografica e Studio Quattroterzi
Styling: Federica Baro
Fotolito e Stampa: Grafiche Antiga

Stampa 07/2020

Richiedi i prodotti
certificati FSC®



Santalucia si riserva la facoltà di apportare, in ogni momento e senza preavviso, ogni modifica ritenuta utile al miglioramento dei propri prodotti.
Santalucia is entitled to make any modification considered useful to improve its products at any time and without notice.



SANTALUCIA MOBILI

Mobilificio Santa Lucia s.p.a.

Prata di Pordenone (PN)
via Manin, 34
T +39 0434 620525
info@santaluciamobili.it
santaluciamobili.it