

Contemporary living

Modern



DOMINGO[®]

Contemporary living

Modern

IDOMINGO®

Ment millacest, omnis nam sintiusanti sus.
Axim dolut que et repedipsam, quam invenis dem
simus, totas nonsequatur? Solum harcil maio et aliquo
vendita tibeaquodi consedi cimilloris exeribus nihillores
eumquam et hictemoste pro doluptincia ex es dolo
venit pellenienis estiassimint et qui bea volorup tioribu
sdanimus, core precearchil molessi dolessus rest ent
unt.

Ment millacest, omnis nam sintiusanti sus.
Axim dolut que et repedipsam, quam invenis dem
simus, totas nonsequatur? Solum harcil maio et aliquo
vendita tibeaquodi consedi cimilloris exeribus nihillores
eumquam et hictemoste pro doluptincia ex es dolo
venit pellenienis estiassimint et qui bea volorup tioribu
sdanimus, core precearchil molessi dolessus rest ent
unt.

Divani
Sofas

Barlow 8

Cox 22

Crosby 36

Foy 51

Tilton 51

Poltrone e pouf
Armchairs and poufs

Afa 66

Parker 80

Duke 80

Dizzy 80

Billy 98

Frank 110

Xxxxxx 122

Tavolini
Small tables

Tabbal 138

Taborn 142

Priamo 144

Tablette 146

Warhol 148

Ceo 150

Febe 150

Rea 150

Teti 150

Divani
Sofas

Barlow 8



Cox 22



Crosby 36



Foy 66



Tilton 80



Poltrone e pouf
Armchairs and poufs

Afa 98

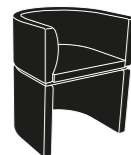

Parker 110

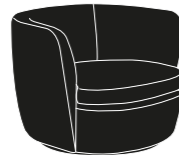

Duke 122

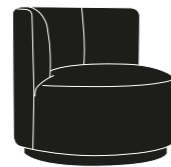

Dizzy 122

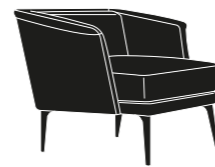

Billy 98



Frank 110



Xxxxxx 122



Tavolini
Small tables

Tabbal 138



Taborn 138



Priamo 138



Tablette 142



Warhol 144



Ceo 150



Febe 148



Rea 144



Teti 146





Divani/ Sofas

Lorem ipsum dolor sit amet,
consectetur adipiscing
elit, sed do eiusmod tempor
incididunt ut labore
et dolore magna aliqua.

But I must explain to you
how all this mistaken idea
of denouncing pleasure
and praising pain was
born and I will give you
a complete account of the
system, and expound the
actual teachings of the
great explorer of the
truth, the master-builder
of human happiness.

Barlow

Il id undi quae sum etur
aped experspedi re accus
expliqu aectamet enitiusae
explaut verferrore derions
equae. Et volorentiam
rem dessedia in comnimi,
sim labor re derferf eribus
ut fugit vererovid mi,
volorrorem alitat ut fugiam,
sape ad quas esentota
inctetur alictotaesed ma
dunt.

Vendera sit ped
minctaquam fugiati
orestot atendi cupta quae
eum ium et, nus maximod
ipsusam facearchit
voluptate nimosapis
minteseque quam arum
quis vellacc umquisciant
magnita quamend ellorio
reptat rerferchil molupti
dis am quia veria int
alitatio optiorr untioirem



Divani Sofas
Domingo—Modern

Barlow

Barlow
Composizione/
Composition

Tavolino/
Small table
Ceo



Divani Sofass
Domingo—Modern

Barlow

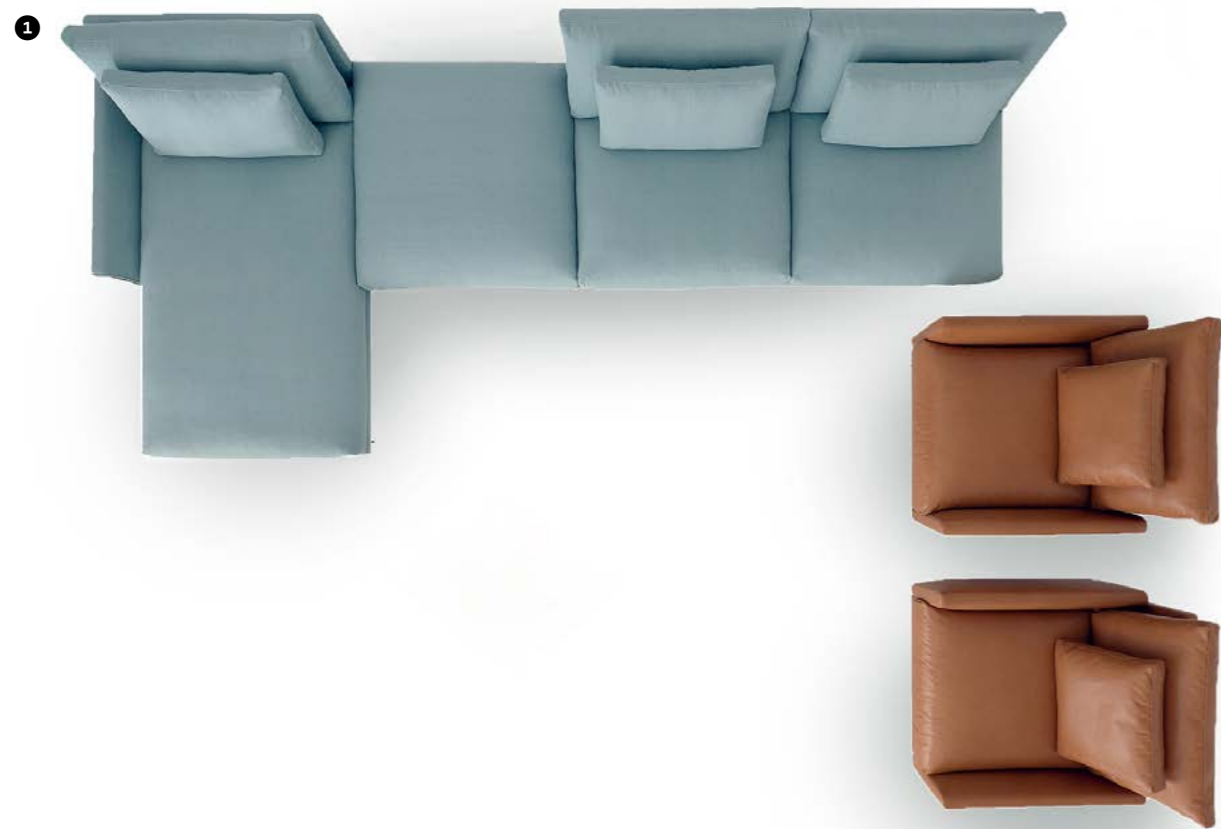

1
1x penisola + 1x pouf + 1x 2P centrale
+ 2x 1P
1x penisola + 1x pouf + 1x2S no
armrests + 2x 1S

2
1x penisola + 1x 2P centrale + 1x 1P
+ 1x pouf
1x penisola + 1x 2S no armrests + 1x
1S + 1x pouf



Divani Sofas
Domingo—Modern

Barlow









Barlow
Composizione/
Composition

Poltrona/
Armchair
Parker

Tavolino/
Small table
Rea
Ceo



Divani Sofas
Domingo—Modern

Thalia



Barlow
 Composizione/
 Composition
 Poltrona/
 Armchair
Parker
 Pouf
Billy
 Tavolino/
 Small table
Rea
Ceo



Barlow
 Composizione/
 Composition
 Poltrona/
 Armchair
Parker
 Tavolino/
 Small table
Rea
Ceo



Divani Sofas
Domingo+Modern

Barlow
Divano tre posti/
Three seater sofa



Barlow
Composizione/
Composition

Tavolino/
Small table
Rea
Ceo

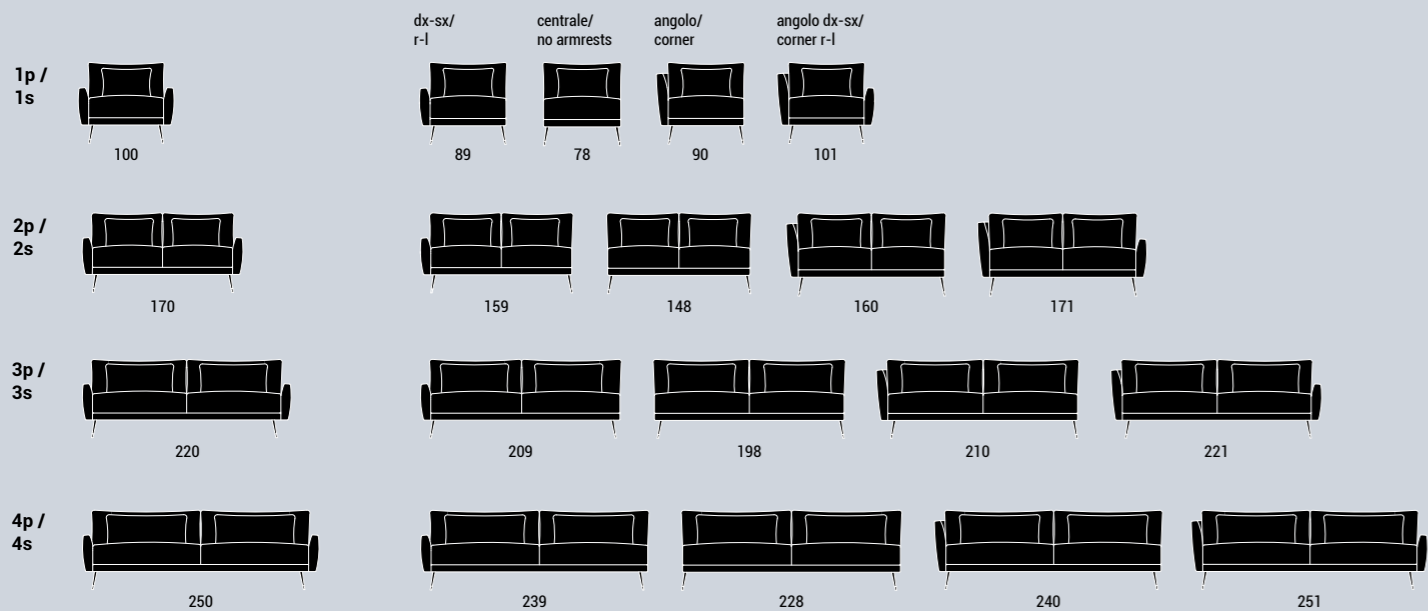

Accessori/
Accessories

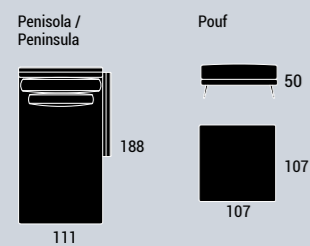

Composizioni suggerite /
Suggested configurations

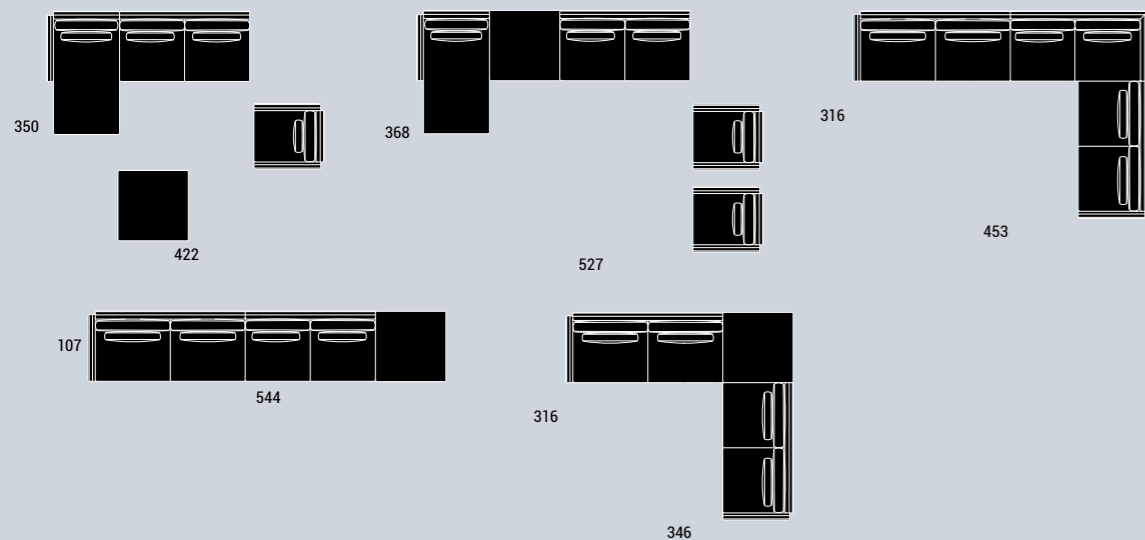

Ro to eatem sinto mod qui dolum volorem quodit doluptur ani dolor ma dolorro in porendis es diti inulles equist valoris adia autam escil et inverore porae non et quia dusdam qui a vit laboriatat et eveliberit moluptis samus etur, quod explatibus. Est, sus ut el esequi debis int aut offic te iur, sum ius venim aliatiiis magnati dite ped

Ro to eatem sinto mod qui dolum volorem quodit doluptur ani dolor ma dolorro in porendis es diti inulles equist valoris adia autam escil et inverore porae non et quia dusdam qui a vit laboriatat et eveliberit moluptis samus etur, quod explatibus. Est, sus ut el esequi debis int aut offic te iur, sum ius venim aliatiiis magnati dite ped

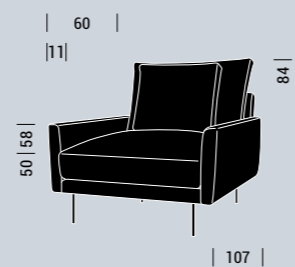

1x penisola SX + 1x pouf + 1x 3P centrale + 2x 1P
1x peninsula L + 1x pouf + 1x 3s no armrests + 2x 1S



1x 3P SX + 1x 2P angolo DX + 1x 3P DX
1x 3S L + 1x 2S corner R + 1x 3S R

Tessuti /
Fabrics



G077 col.09
cat. elegant



Lux col.2434
cat. top



8336 col.53
cat. lusso



Versioni di cuciture
dei braccioli
xxxxx xxxxxxxx xxxxx
xxxxxxxx xxxxx



Versioni di cuciture
dei cuscini
xxxxx xxxxxxxx xxxxx
xxxxxxxx xxxxx



H 18
Piedi in metallo verniciato
nero con puntale in oro
Piedi in metallo verniciato
nero con puntale in oro



H 18
Piedi in metallo verniciato
Varnished metal feet

Divani Sofas
Domingo—Modern

Barlow

Il id undi quae sum etur
aped experspedi re accus
expliqu aectamet enitiusae
explaut verferrore derions
equae. Et volorentiam
rem dessedia in comnimi,
sim labor re derferf eribus
ut fugit vererovid mi,
volorrorem alitat ut fugiam,
sape ad quas esentota
inctetur alictotaesed ma
dunt.

Vendera sit ped
minctaquam fugiati
orestot atendi cupta quae
eum ium et, nus maximod
ipsusam facearchit
voluptate nimosapis
minteseque quam arum
quis vellacc umquisciant
magnita quamend ellorio
reptat rerferchil molupti
dis am quia veria int
alitatio optiorr untioirem



Divani Sofas
Domingo—Modern

Cox

Cox
Composizione/
Composition

Tavolino/
Small table
Taborn
Warhol



Divani Sofas
Domingo—Modern

Cox



- 1 1x angolo 2P SX + 2x angolo 2P DX +
1x pouf
1x corner 2S L + 2x corner 2S R + 1x
pouf
- 2 1x angolo 2P SX + 1x pouf
1x corner 2S L + 1x pouf
- 3 1x angolo 2P SX + 1x angolo 2P DX +
2x poufs
1x corner 2S L + 1x corner 2S R + 2x
poufs
- 4 1x penisola + 1x angolo 4P DX + 1x 1P
+ 1x pouf
1x penisola + 1x corner 4S R + 1x 1S
+ 1x pouf



Cox
Composizione/
Composition

Poltrona/
Armchair
Duke

Tavolino/
Small table
Taborn
Warhol

Cox
Composizione/
Composition

Poltrna/
Armchair
Duke

Tavolino/
Small table
Taborn
Warhol



Divani Sofas
Domingo—Modern

Cox



Cox
Composizione/
Composition

Poltrona/
Armchair
Duke

Tavolino/
Small table
Taborn
Warhol



Divani Sofas
Domingo—Modern

Barlow

Cox
Composizione/
Composition

Tavolino/
Small table
Warhol
Ceo



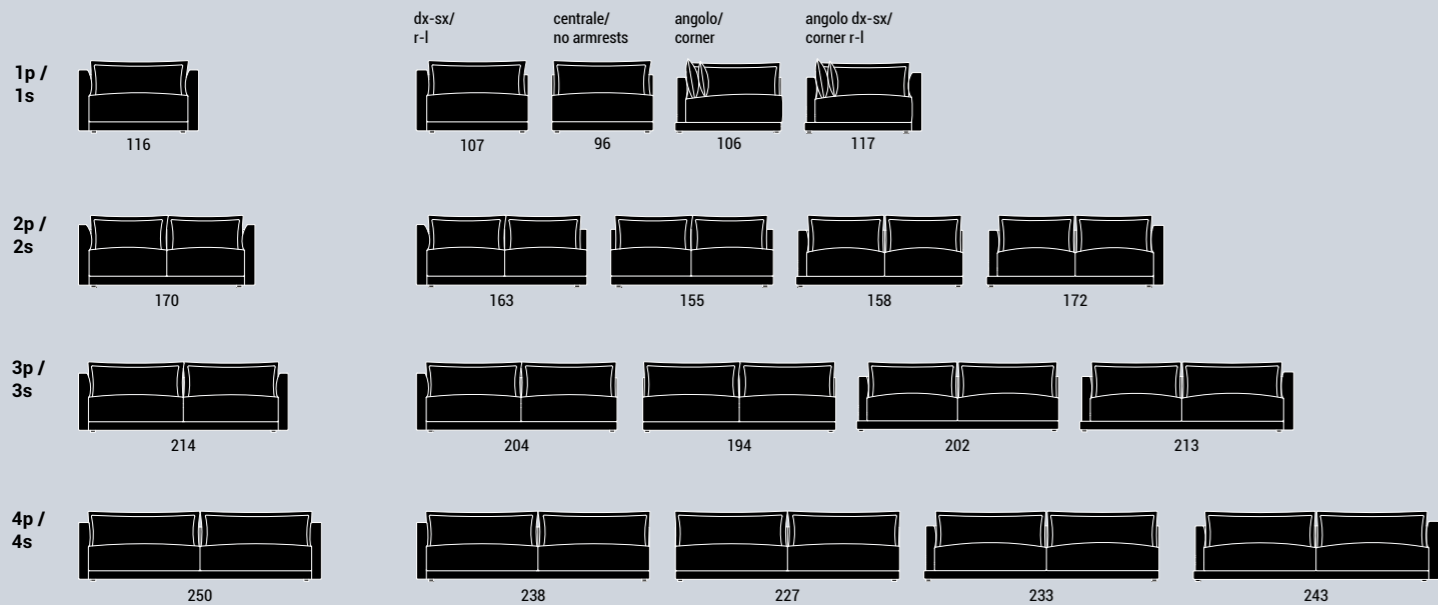

Accessori / Accessories

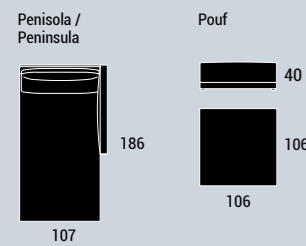

Composizioni suggerite / Suggested configurations

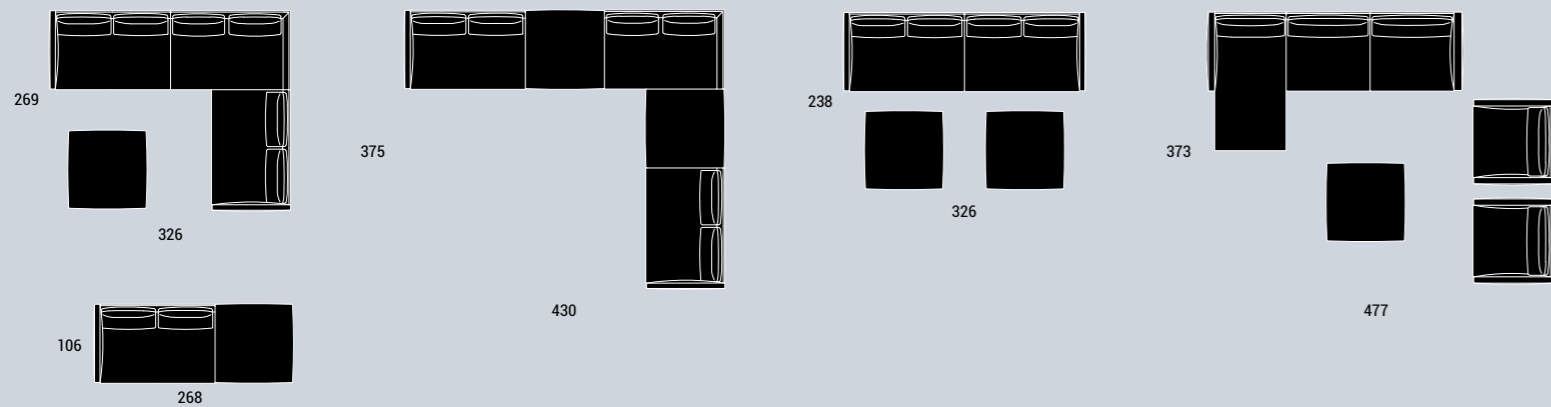

Ro to eatem sinto mod qui dolum volorem quodit doluptur ani dolor ma dolorro in porendis es diti inulles equist valoris adia autam escil et inverore porae non et quia dusdam qui a vit laboriatat et eveliberit moluptis samus etur, quod explatibus. Est, sus ut el esequi debis int aut offic te iur, sum ius venim aliatiiis magnati dite ped

Ro to eatem sinto mod qui dolum volorem quodit doluptur ani dolor ma dolorro in porendis es diti inulles equist valoris adia autam escil et inverore porae non et quia dusdam qui a vit laboriatat et eveliberit moluptis samus etur, quod explatibus. Est, sus ut el esequi debis int aut offic te iur, sum ius venim aliatiiis magnati dite ped

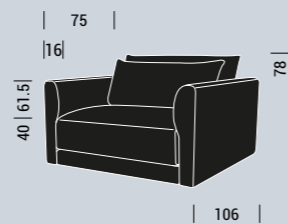

Cox



1x 2P SX + 2x pouf + 1x angolo 2P DX + 1x 2P DX
1x 2S L + 2x poufs + 1x corner 2S R + 1x 2S R



1x penisola SX + 1x angolo 4P DX + 2x 1P + 1x pouf
1x penisola L + 1x corner 4S R + 2x 1S + 1x pouf

Tessuti / Fabrics



L1649 col.04
cat. lusso



M036 col.20
cat. extra

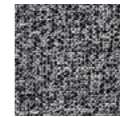

M039 col.01
cat. extra



G075 col.414
cat. elegant



P 59
H 2
Piedi in legno tinto
Stained wooden feet

Divani Sofas
Domingo—Modern

Cox

Crosby

Il id undi quae sum etur
aped experspedi re accus
expliqu aectamet enitiusae
explaut verferrore derions
equae. Et volorentiam
rem dessedia in comnimi,
sim labor re derferf eribus
ut fugit vererovid mi,
volorrorem alitat ut fugiam,
sape ad quas esentota
inctetur alictotaesed ma
dunt.

Vendera sit ped
minctaquam fugiati
orestot atendi cupta quae
eum ium et, nus maximod
ipsusam facearchit
voluptate nimosapis
minteseque quam arum
quis vellacc umquisciant
magnita quamend ellorio
reptat rerferchil molupti
dis am quia veria int
alitatio optiorr untioirem



Divani Sofas
Domingo—Modern

Crosby

Crosby
Composizione/
Composition

Tavolino/
Small table
Priamo



Divani Sofas
Domingo—Modern

Crosby



Divani Sofas
Domingo—Modern

Crosby



Divani Sofas
Domingo—Modern



Crosby



Divani Sofas
Domingo—Modern

Crosby

**Modularità
Modularity**

Pouf
Pouf



Tubolare metallico
Metal tubular frame

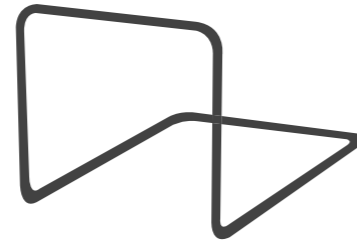

Cuscino large
Large cushion



Cuscino small
Small cushion



Poltrona
Armchair



Tubolare metallico
Metal tubular frame

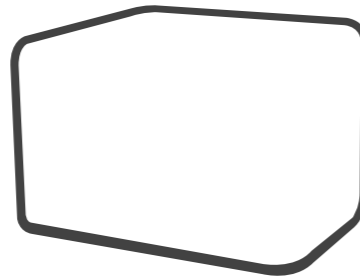

Cuscino large
Large cushion



Cuscino small
Small cushion



Angolo
Corner



**Varianti di posizione dei cuscini
Cushion possibility of positioning**



Gli schienali posso essere fissati meglio con l'utilizzo di una cerniera posizionata nella parte sotto dei cuscini.
Gli schienali posso essere fissati meglio con l'utilizzo di una cerniera posizionata nella parte sotto dei cuscini.

**Accessori
Accessories**



100x50



60x50

L'elemento 50x50 può avere come optional il vassoio in metallo tagliato a laser.
The module 50x50 can optionally have a laser-cut metal tray.



Poltrona
Armchair

Angolo
Corner

Divani Sofas
Domingo—Modern

Crosby

Sistema di aggancio
Connection fittings

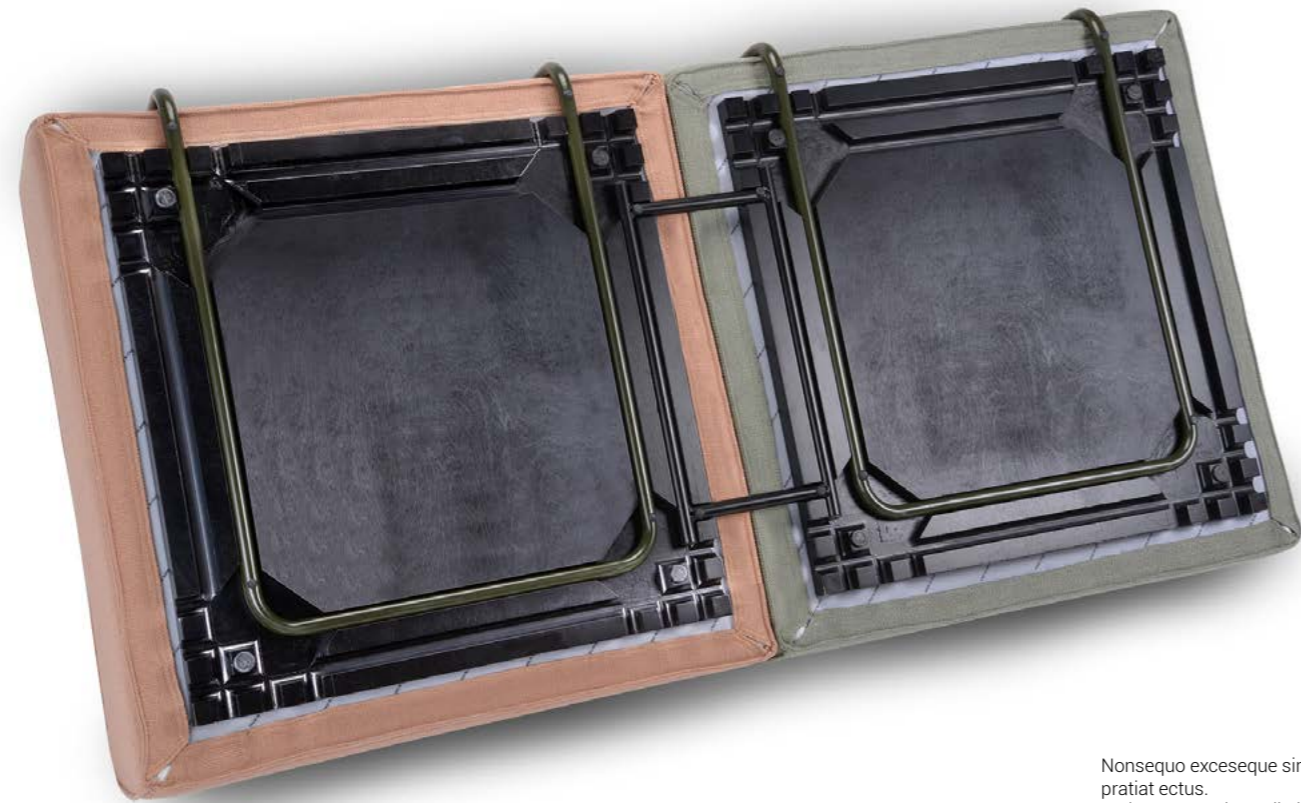
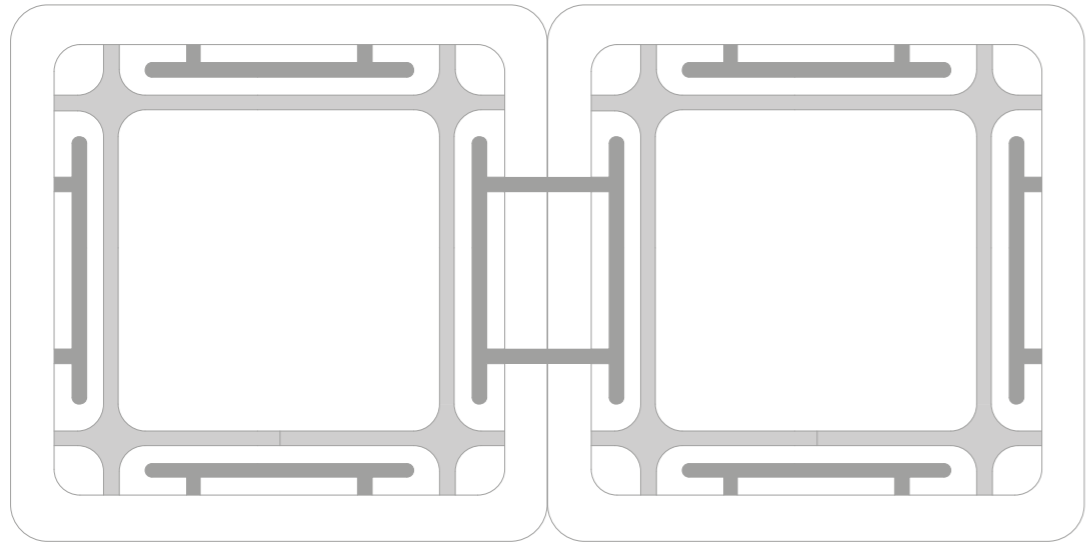

Nonsequo exceseque sin pre in pratiat ectus. Sed quosamenis as di nis et laccum enitatur? Arum re quia nam dolorumquam niendit volupta tionsequodi untionsequo expliqui volecum doloris quatus, verrorit endita si.

Nonsequo exceseque sin pre in pratiat ectus. Sed quosamenis as di nis et laccum enitatur? Arum re quia nam dolorumquam niendit volupta tionsequodi untionsequo expliqui volecum doloris quatus, verrorit endita si.



Nonsequo exceseque sin pre in pratiat ectus. Sed quosamenis as di nis et laccum enitatur? Arum re quia nam dolorumquam niendit volupta tionsequodi untionsequo expliqui volecum doloris quatus, verrorit endita si.

Nonsequo exceseque sin pre in pratiat ectus. Sed quosamenis as di nis et laccum enitatur? Arum re quia nam dolorumquam niendit volupta tionsequodi untionsequo expliqui volecum doloris quatus, verrorit endita si.



Divani Sofas
Domingo—Modern

Crosby

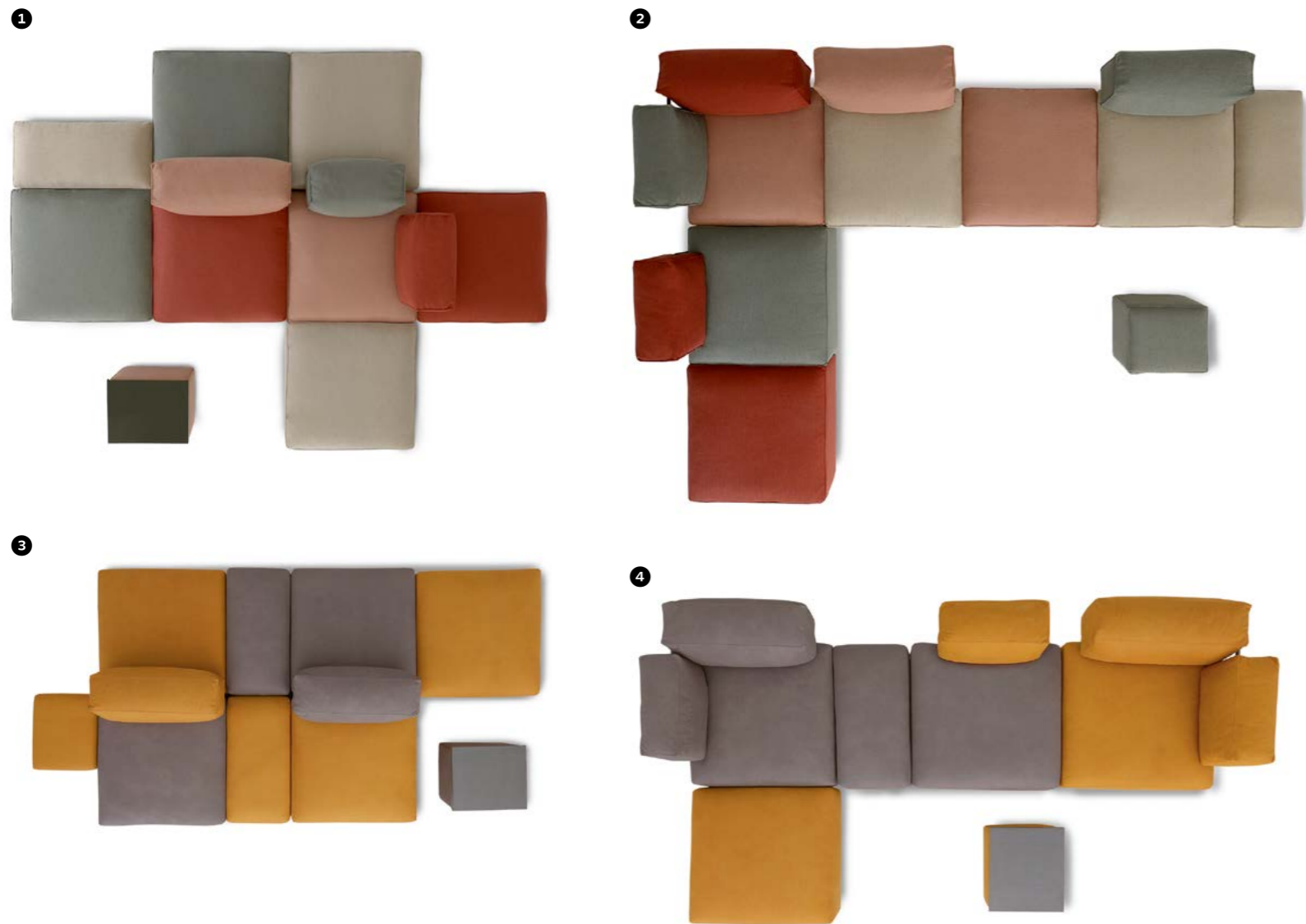

6x pouf + 1x el. 100x60 + 1x el. 60x50
con vassoio + 2x cuscino small + 1x cuscino
large + 1x tubolare angolo + 1x tubolare
poltrona

2

6x pouf + 1x el. 100x60 + 1x el. 60x50 with tray
+ 2x small cushion + 1x large cushion + 1x
corner metal tubular frame + 1x armchair
metal tubular frame

3

5x pouf + 2x el. 100x60 + 2x el. 60x50, uno
con vassoio + 2x cuscino large + 2x tubolari
poltrona

4

4x pouf + 1x el. 100x60 + 1x el. 60x50 con
vassoio + 2x cuscino large + 3x cuscini small
+ 2x tubolari angolo + 1x tubolare poltrona

Moduli / Modules

Pouf

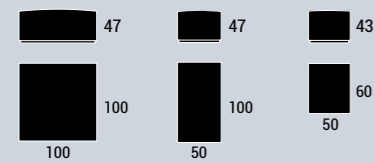

Tubolare poltrona / Armchair tubular frame

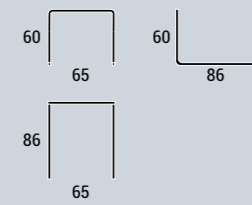

Tubolare angolo / Corner tubular frame

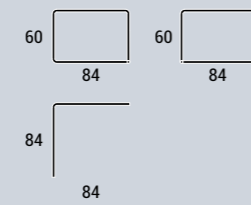

Cuscino large / Large cushion



Cuscino small / Small cushion

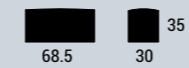

Composizioni suggerite / Suggested configurations

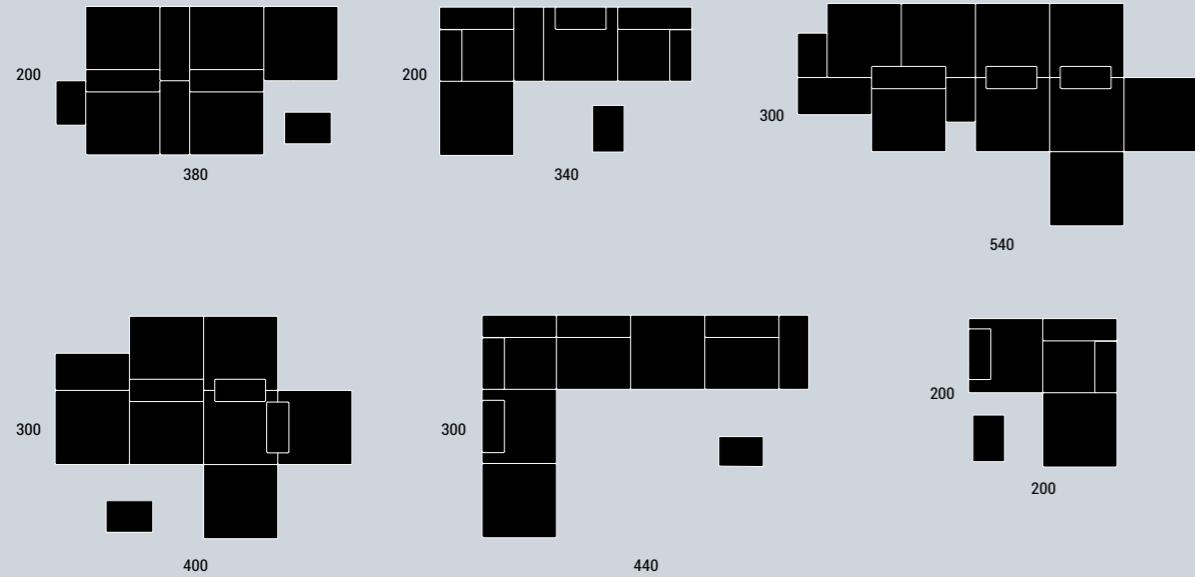

Varianti di profondità seduta in base alla posizione del cuscino /
 XXXXXX XXXXX XXX XXXX XXXXXXXXXXXX
 XXXXX XXXXX XXX XXXX XXXXXXXXXXXX

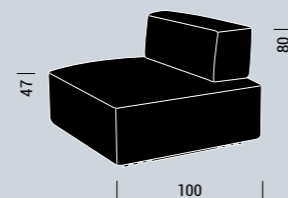
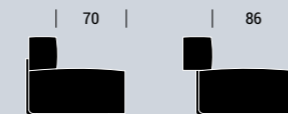

Ro to eatem sinto mod qui dolum volorem quodit doluptur ani dolor ma dolorro in porendis es diti inulles equist valoris adia autam escil et inverore porae non et quia dusdam qui a vit laboriatat et eveliberit moluptis samus etur, quod explatibus. Est, sus ut el esequi debis int aut offic te iur, sum ius venim aliatiiis magnati dite ped

Ro to eatem sinto mod qui dolum volorem quodit doluptur ani dolor ma dolorro in porendis es diti inulles equist valoris adia autam escil et inverore porae non et quia dusdam qui a vit laboriatat et eveliberit moluptis samus etur, quod explatibus. Est, sus ut el esequi debis int aut offic te iur, sum ius venim aliatiiis magnati dite ped

Crosby



7x pouf + 1x el.100x60 + 1x el.60x50 + 1x cuscino large + 2x cuscini small + 1x tubolare angolo + 1x tubolari poltrona
 7x poufs + 1x el.100x60 + 1x el.60x50 + 1x large cushion + 2x small cushions + 1x corner metal tubular frame +1x armchair metal tubular frame



5x pouf + 2x el.60x50 + 2x el.100x60 + 2x cuscini small + 2x tubolare poltrona
 5x poufs + 2x el.60x50 + 2x el.100x60 + 2x small cushions + 2x armchair metal tubular frames



9x pouf + 1x el.100x60 + 2x el.60x50 + 1x cuscino large + 2x cuscini small + 2x tubolari poltrona
 9x poufs + 1x el.100x60 + 2x el.60x50 + 1x large cushions + 2x small cushions +2x armchair metal tubular frames



3x pouf + 1x el.60x50 con vassoio + 1x cuscino large + 2x cuscini small + 1x tubolare angolo + 1x tubolare poltrona
 3x poufs + 1x el.60x50 with tray + 1x large cushion + 2x small cushions + 1x corner metal tubular frames + 1x armchair metal tubular frames



6x pouf + 1x el.100x60 + 1x el.60x50 con vassoio + 3x cuscini large + 2x cuscini small + 3x tubolari poltrona + 1x tubolare angolo
 6x poufs + 1x el.100x60 + 1x el.60x50 with tray + 3x large cushions + 2x small cushions + 3x armchair metal tubular frames + 1x corner metal tubular frame



4x pouf + 1x el.60x50 con vassoio + 1x el.100x60 + 2x cuscino large + 2x cuscini small + 2x tubolare angolo
 4x poufs + 1x el.60x50 with tray + 1x el.100x60 + 2x large cushions + 2x small cushions + 2x corner metal tubular frames

Tessuti / Fabrics



Tubolari in metallo verniciato
 Varnished tubular metal frame
 Ral 6006 opaco/matt



Tubolari in metallo verniciato
 effetto grigio industriale
 XXXXXXX XXXXXX XXXXXXX
 XXXXXXX



H 3
 Struttura in legno verniciato nero /
 Varnished black wooden frame

Versioni di cuciture
 XXXXX XXXXXXX XXXX

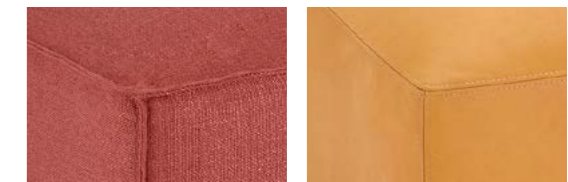

Divani Sofas
 Domingo—Modern

Crosby

Foy

design **Baldessari e Baldessari**

Il id undi quae sum etur
aped experspedi re accus
expliqu aectamet enitiusae
explaut verferrore derions
equae. Et volorentiam
rem dessedia in comnimi,
sim labor re derferf eribus
ut fugit vererovid mi,
volorrorem alitat ut fugiam,
sape ad quas esentota
inctetur alictotaesed ma
dunt.

Vendera sit ped
minctaquam fugiati
orestot atendi cupta quae
eum ium et, nus maximod
ipsusam facearchit
voluptate nimosapis
minteseque quam arum
quis vellacc umquisciant
magnita quamend ellorio
reptat rerferchil molupti
dis am quia veria int
alitatio optiorr untioirem



Divani Sofas
Domingo—Modern

Foy

Foy
Divano tre posti-
poltrona-pouf/
Three seater sofa-
armchair-pouf

Tavolino/
Small table
Priamo



Divani Sofass
Domingo—Modern

Foy



Divani Sofas
Domingo—Modern

Foy



Divani Sofas
Domingo—Modern

Thalia



Divani Sofas
Domingo—Modern

Foy



Foy
Poltrona/
Armchair



Divani Sofas
Domingo—Modern



Foy



Divani Sofas
Domingo—Modern

Foy

Crosby
Composizione/
Composition

Tavolino/
Small table
Priamo





1p /
1s



101.5

2p /
2s



192

3p /
3s



235

Accessori/
Accessories

Pouf



45



87

120

Ro to eatem sinto mod qui dolum volorem quodit doluptur ani dolor ma dolorro in porendis es diti inulles equist voloris adia autam escil et inverore porae non et quia dusdam qui a vit laboriatat et eveliberit moluptis samus etur, quod explatibus. Est, sus ut el esequi debis int aut offic te iur, sum ius venim aliatiiis magnati dite ped

Ro to eatem sinto mod qui dolum volorem quodit doluptur ani dolor ma dolorro in porendis es diti inulles equist voloris adia autam escil et inverore porae non et quia dusdam qui a vit laboriatat et eveliberit moluptis samus etur, quod explatibus. Est, sus ut el esequi debis int aut offic te iur, sum ius venim aliatiiis magnati dite ped

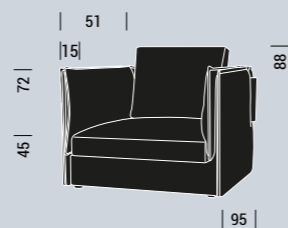

1x pouf + 1x 3P + 1x 1P
1x pouf + 1x 3S + 1x 1S



2x 1P + 1x 3P
2x 1S + 1x 3S



1x 2P + 1x pouf
1x 2S + 1x pouf

Tessuti /
Fabrics



Moon col.686
cat. extreme



2124 col.5
cat. elegant



G105 col.6296
cat. extreme



Moon col.686
cat. extreme



2124 col.5
cat. elegant

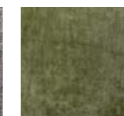

G105 col.6296
cat. extreme



Sancho col.30
cat. elegant



G077 col.18
cat. extreme



Moon col.651
cat. extreme



Raytent 3706
col.708
cat. super



P 59
H 2

Piedi in legno tinto
Stained wooden feet

Divani Sofas

Domingo—Modern

Foy

Tilton

Il id undi quae sum etur
aped experspedi re accus
expliqu aectamet enitiusae
explaut verferrore derions
equae. Et volorentiam
rem dessedia in comnimi,
sim labor re derferf eribus
ut fugit vererovid mi,
volorrorem alitat ut fugiam,
sape ad quas esentota
inctetur alictotaesed ma
dunt.

Vendera sit ped
minctaquam fugiati
orestot atendi cupta quae
eum ium et, nus maximod
ipsusam facearchit
voluptate nimosapis
minteseque quam arum
quis vellacc umquisciant
magnita quamend ellorio
reptat rerferchil molupti
dis am quia veria int
alitato optiorr untiozem



Divani Sofas
Domingo—Modern

Tilton

Tilton
Composizione/
Composition

Poltrona/
Armchair
Dizzy

Pouf
Billy

Tavolino/
Small table
Taborn



Divani Sofas
Domingo—Modern

Tilton

Tilton
Composizione/
Composition

Pouf
Billy

Tavolino/
Small table
Taborn

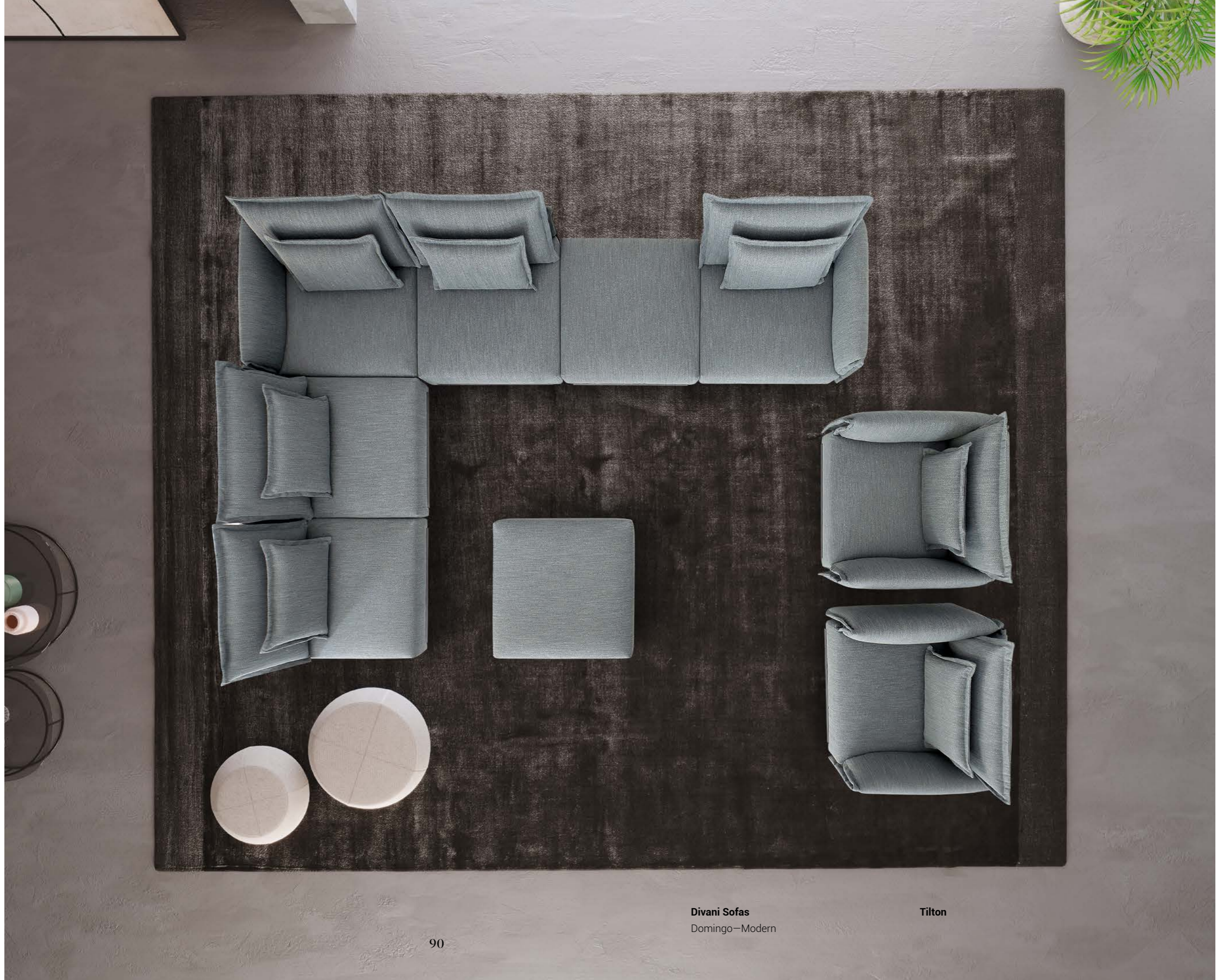

Divani Sofas
Domingo—Modern

Tilton



Divani Sofas
Domingo—Modern

Tilton



Nonsequo exceseque sin pre in
 pratiat ectus.
 Sed quosamenis as di nis et
 laccum enitatur?
 Arum re quia nam dolorumquam
 niendit volupta tionsequodi
 untionsequo expliqui volecum
 doloris quatus, verrorit endita si.

Nonsequo exceseque sin pre in
 pratiat ectus.
 Sed quosamenis as di nis et
 laccum enitatur?
 Arum re quia nam dolorumquam
 niendit volupta tionsequodi
 untionsequo expliqui volecum
 doloris quatus, verrorit endita si.



Divani Sofas
 Domingo—Modern

Tilton

Tilton
Pouf-Poltrona-
Divano 2 posti-
Divano 3 posti/
Pouf-Armchair-
Two seater sofa-
Three seater sofa



Tilton
Composizione/
Composition

Pouf
Billy

Tavolino/
Small table
Taborn



Tilton
Poltrona/
Armchair



Divani Sofas
Domingo—Modern

Tilton



**Moduli/
Modules**

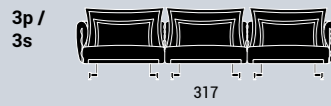
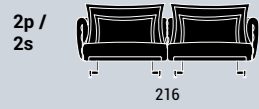
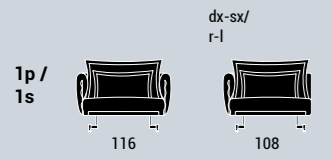

**Composizioni suggerite /
Suggested configurations**

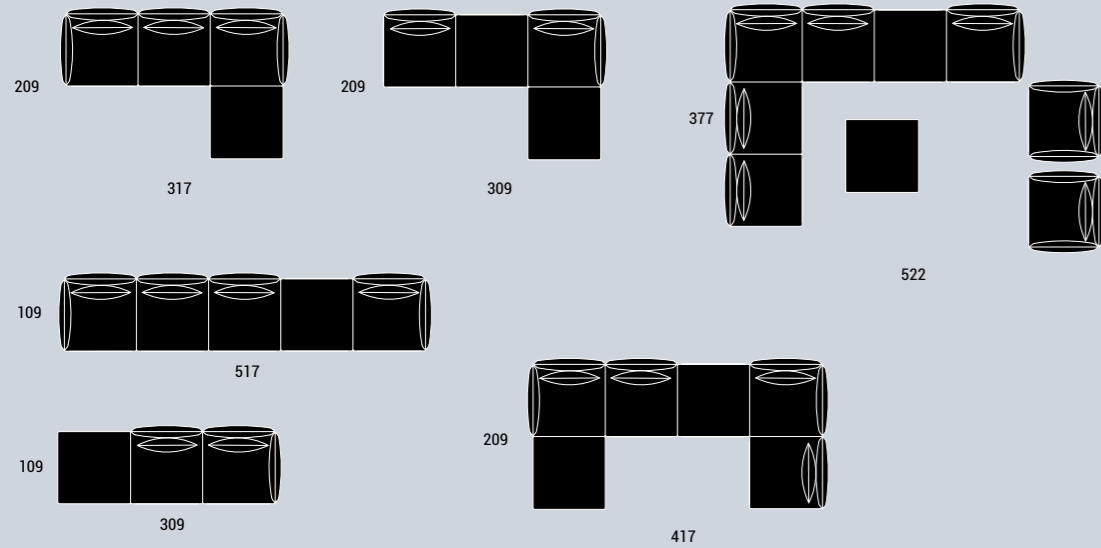

Ro to eatem sinto mod qui dolum volorem quodit doluptur ani dolor ma dolorro in porendis es diti inulles equist valoris adia autam escil et inverore porae non et quia dusdam qui a vit laboriatat et eveliberit moluptis samus etur, quod explatibus. Est, sus ut el esequi debis int aut offic te iur, sum ius venim aliatiiis magnati dite ped

Ro to eatem sinto mod qui dolum volorem quodit doluptur ani dolor ma dolorro in porendis es diti inulles equist valoris adia autam escil et inverore porae non et quia dusdam qui a vit laboriatat et eveliberit moluptis samus etur, quod explatibus. Est, sus ut el esequi debis int aut offic te iur, sum ius venim aliatiiis magnati dite ped

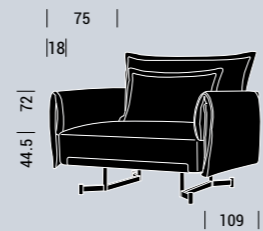

7x pouf + 12x braccioli + 7x cuscini 100x58 + 7x cuscini 70x40
7x poufs + 12x armrests + 7x cushions 100x58 + 7x cushions 70x40



6x pouf + 6x braccioli + 4x cuscini 100x58 + 4x cuscini 70x40
6x pouf + 6x armrests + 4x cushion 100x58 + 4x cushion 70x40

**Tessuti /
Fabrics**



G192 col.19
cat. elegant



04250 Levante
col.315
cat. xxxxx

Base verniciata
Ral 9016 lucido
XXXXXX XXXXXX
XXXXXXXX XXXXXX



Cuscini con frappe decorative
XXXXX XXXXXXXXXXX XXXX
XXXXX XXXXXXXXXXX XXXX



Incisione laser del logo Domingo sulla lamiera sotto il cuscino seduta
XXXXX XXXXXXXXXXX XXXX
XXXXX XXXXXXXXXXX XXXX
XXXXX XXXXXXXXXXX XXXX

H 20

Struttura in metallo verniciato
Varnished metal frame

Divani Sofas
Domingo—Modern



Poltrone e pouf/ Armchairs and poufs

Lorem ipsum dolor sit amet,
consectetur adipiscing
elit, sed do eiusmod tempor
incididunt ut labore
et dolore magna aliqua.

But I must explain to you
how all this mistaken idea
of denouncing pleasure
and praising pain was
born and I will give you
a complete account of the
system, and expound the
actual teachings of the
great explorer of the
truth, the master-builder
of human happiness.

107

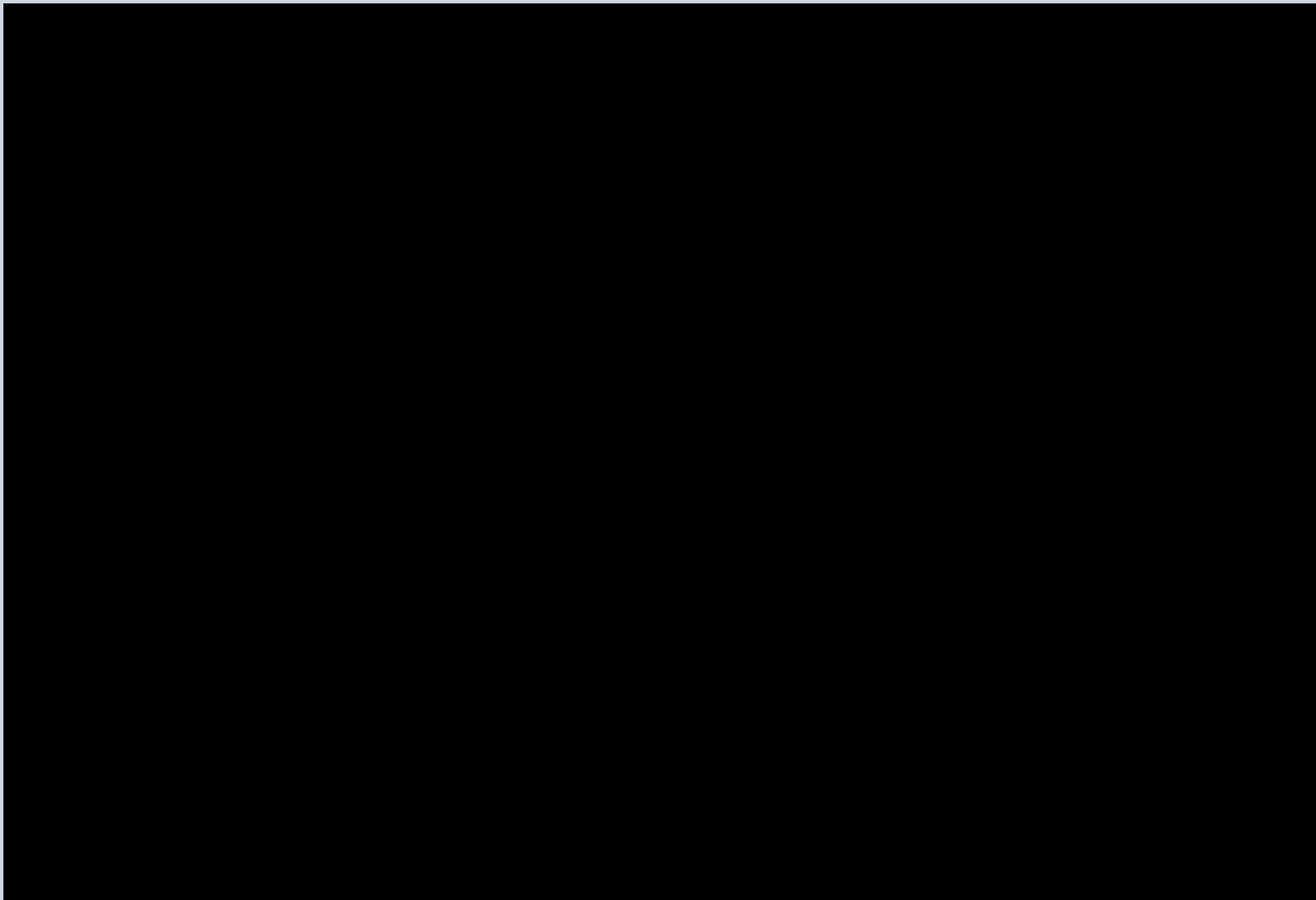

Tessuti /
Fabrics



G192 col.19
cat. elegant

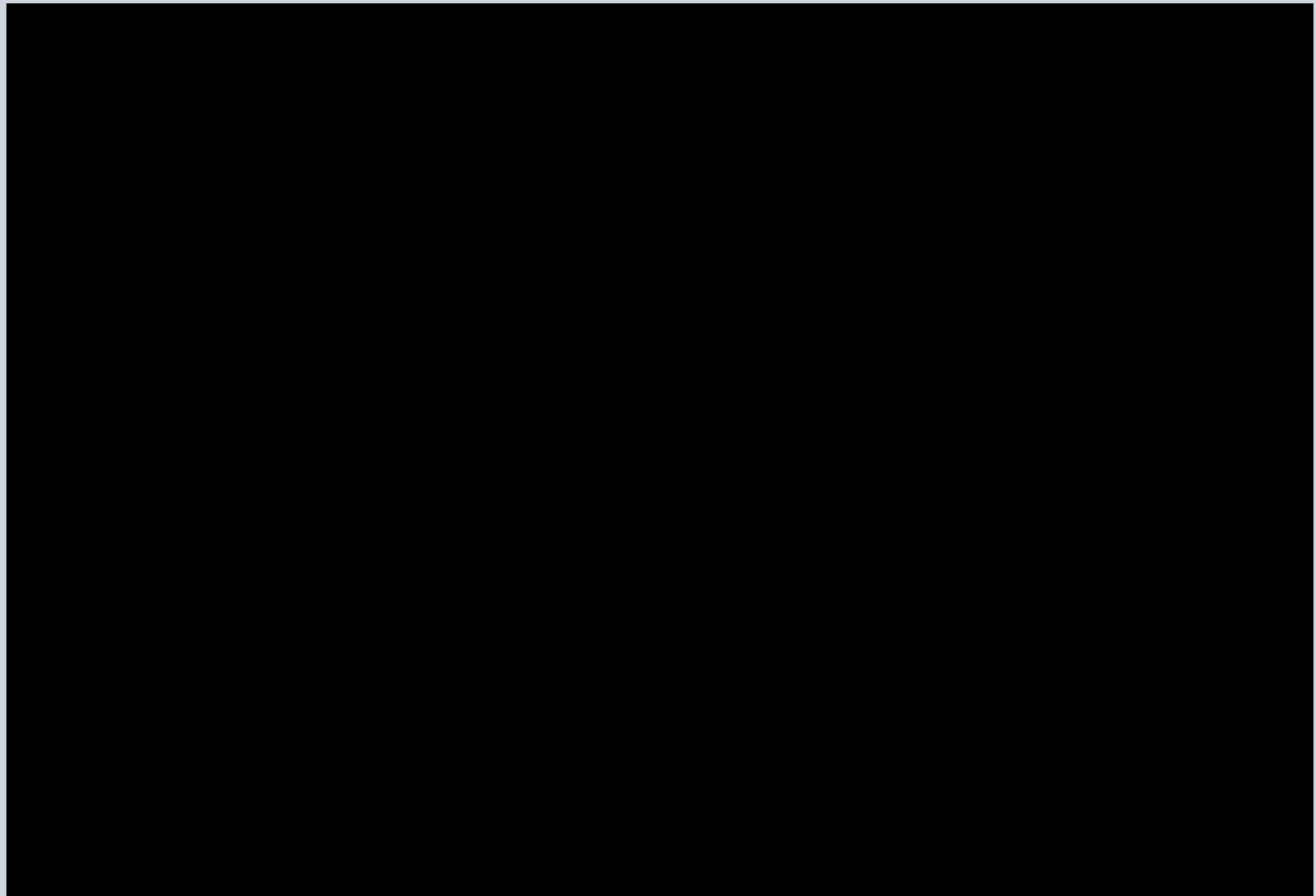

H 20

Base in metallo verniciato
Varnished metal base



Tessuti /
Fabrics



G192 col.19
cat. elegant

Ro to eatem sinto mod qui dolum volorem
quodit doluptur ani dolor ma dolorro in
porendis es diti inulles equist voloris adia
autam escil et inverore porae non et quia
dusdam qui a vit laboriatat et eveliberit
moluptis samus etur, quod explatibus.
Est, sus ut el esequi debis int aut offic te iur,
sum ius venim aliatiiis magnati dite ped

Ro to eatem sinto mod qui dolum volorem
quodit doluptur ani dolor ma dolorro in
porendis es diti inulles equist voloris adia
autam escil et inverore porae non et quia
dusdam qui a vit laboriatat et eveliberit
moluptis samus etur, quod explatibus.
Est, sus ut el esequi debis int aut offic te iur,
sum ius venim aliatiiis magnati dite ped

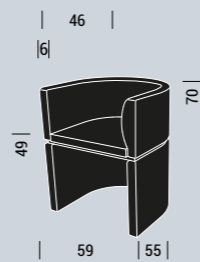

Ro to eatem sinto mod qui dolum volorem
quodit doluptur ani dolor ma dolorro in
porendis es diti inulles equist voloris adia
autam escil et inverore porae non et quia
dusdam qui a vit laboriatat et eveliberit
moluptis samus etur, quod explatibus.
Est, sus ut el esequi debis int aut offic te iur,
sum ius venim aliatiiis magnati dite ped

Ro to eatem sinto mod qui dolum volorem
quodit doluptur ani dolor ma dolorro in
porendis es diti inulles equist voloris adia
autam escil et inverore porae non et quia
dusdam qui a vit laboriatat et eveliberit
moluptis samus etur, quod explatibus.
Est, sus ut el esequi debis int aut offic te iur,
sum ius venim aliatiiis magnati dite ped

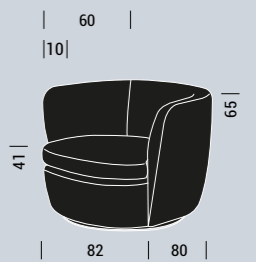

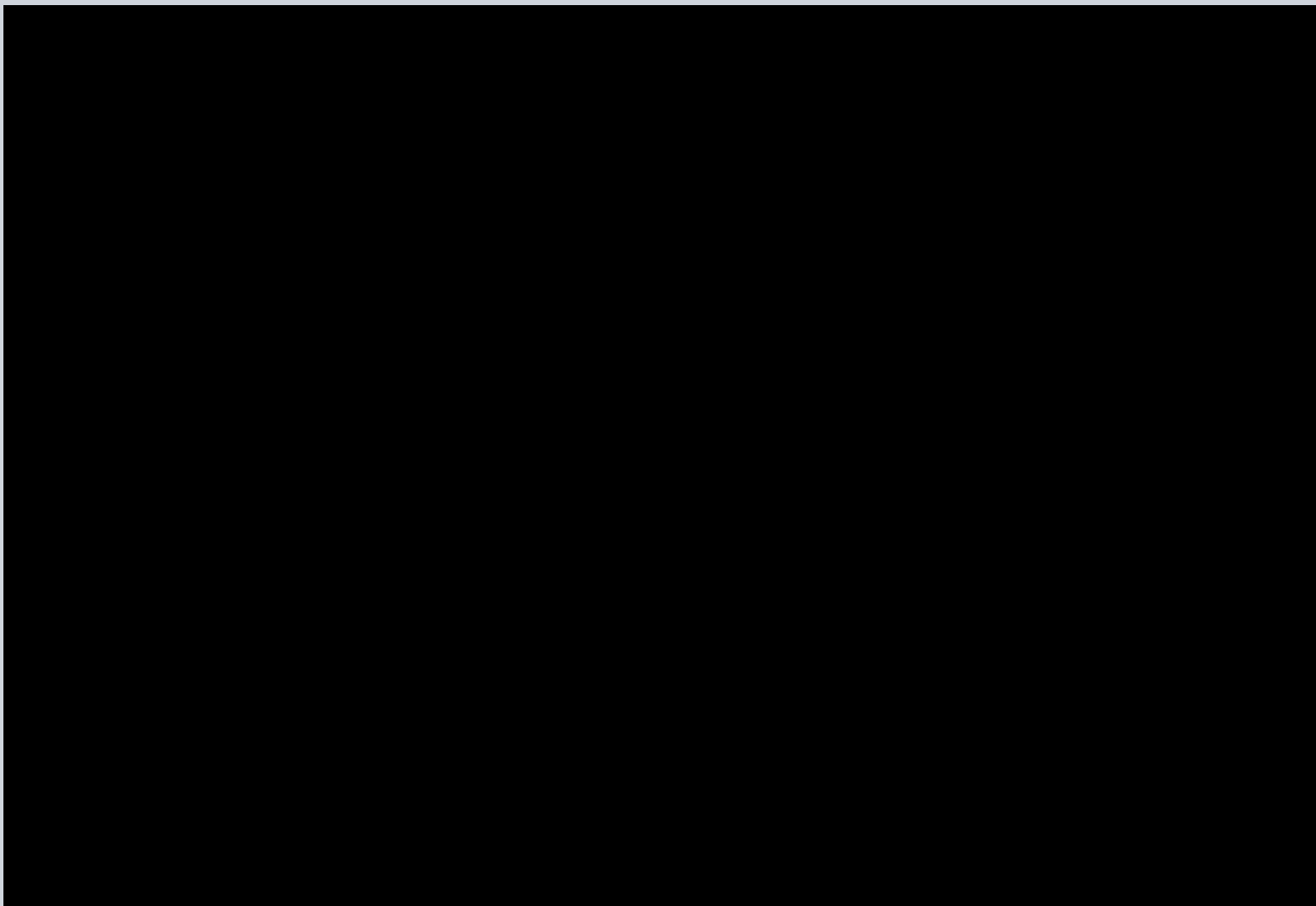

H 20
Base in metallo verniciato
Varnished metal base

Tessuti /
Fabrics



G192 col.19
cat. elegant

Ro to eatem sinto mod qui dolum volorem quodit doluptur ani dolor ma dolorro in porendis es diti inulles equist voloris adia autam escil et inverore porae non et quia dusdam qui a vit laboriatat et eveliberit moluptis samus etur, quod explatibus. Est, sus ut el esequi debis int aut offic te iur, sum ius venim aliatiiis magnati dite ped

Ro to eatem sinto mod qui dolum volorem quodit doluptur ani dolor ma dolorro in porendis es diti inulles equist voloris adia autam escil et inverore porae non et quia dusdam qui a vit laboriatat et eveliberit moluptis samus etur, quod explatibus. Est, sus ut el esequi debis int aut offic te iur, sum ius venim aliatiiis magnati dite ped

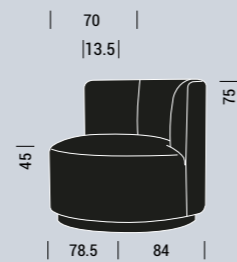

Duke

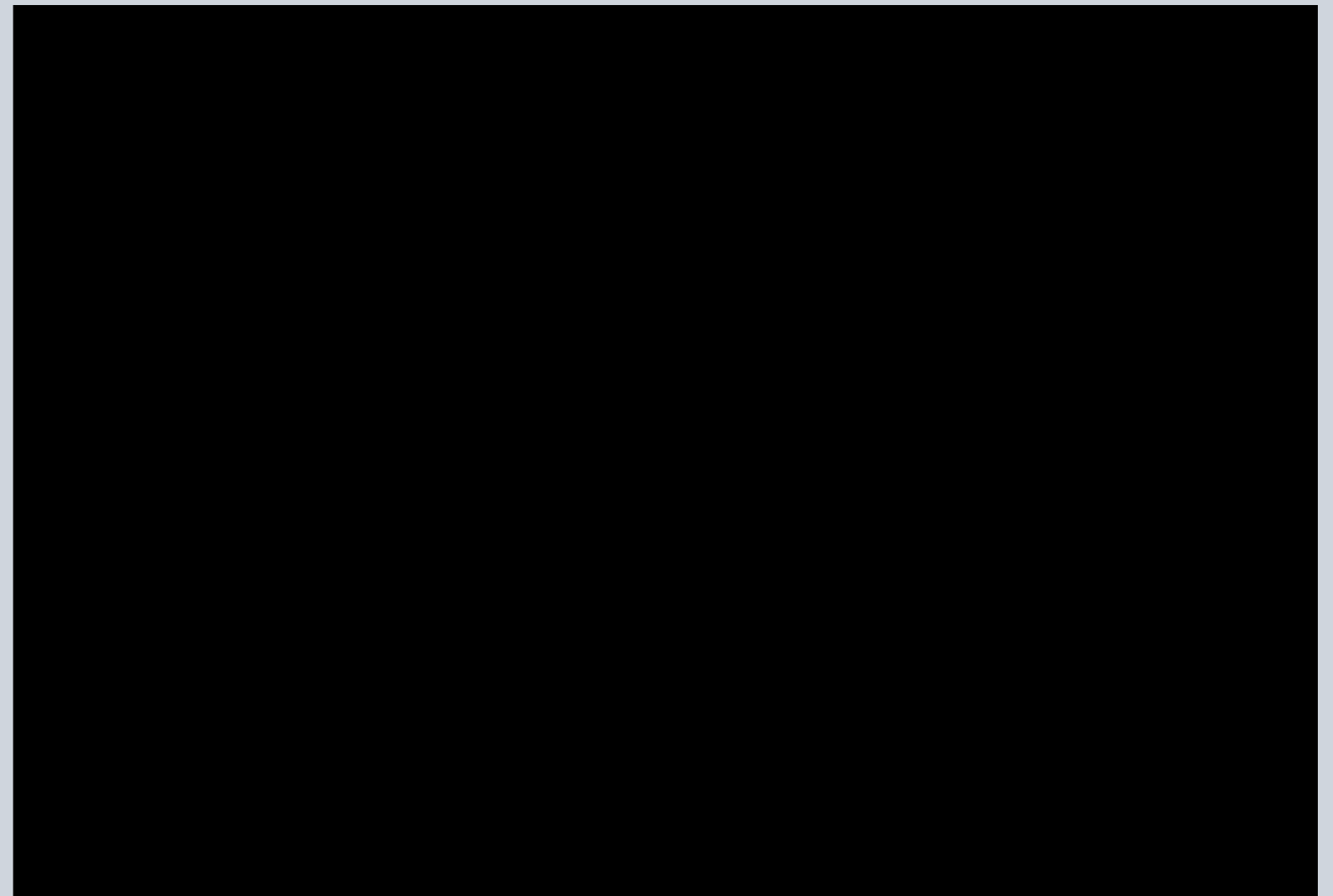

H 20
Base in metallo verniciato
Varnished metal base

Tessuti /
Fabrics

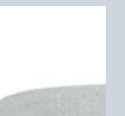

G192 col.19
cat. elegant

Ro to eatem sinto mod qui dolum volorem quodit doluptur ani dolor ma dolorro in porendis es diti inulles equist voloris adia autam escil et inverore porae non et quia dusdam qui a vit laboriatat et eveliberit moluptis samus etur, quod explatibus. Est, sus ut el esequi debis int aut offic te iur, sum ius venim aliatiiis magnati dite ped

Ro to eatem sinto mod qui dolum volorem quodit doluptur ani dolor ma dolorro in porendis es diti inulles equist voloris adia autam escil et inverore porae non et quia dusdam qui a vit laboriatat et eveliberit moluptis samus etur, quod explatibus. Est, sus ut el esequi debis int aut offic te iur, sum ius venim aliatiiis magnati dite ped

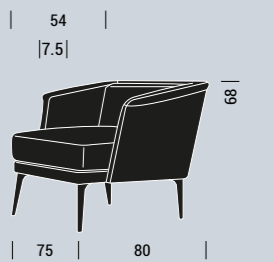

Dizzy

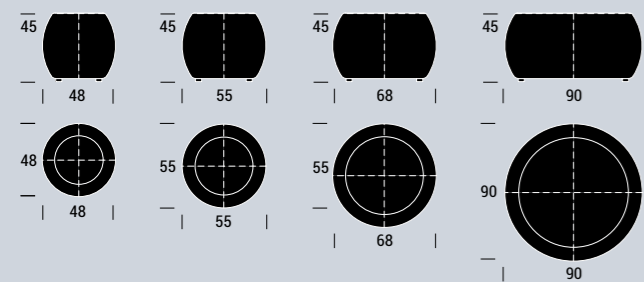

Tessuti /
Fabrics



G192 col.19
cat. elegant

Ro to eatem sinto mod qui dolum volorem
quodit doluptur ani dolor ma dolorro in
porendis es diti inulles equist voloris adia
autam escil et inverore porae non et quia
dusdam qui a vit laboriatat et eveliberit
moluptis samus etur, quod explatibus.
Est, sus ut el esequi debis int aut offic te iur,
sum ius venim aliatiiis magnati dite ped

Ro to eatem sinto mod qui dolum volorem
quodit doluptur ani dolor ma dolorro in
porendis es diti inulles equist voloris adia
autam escil et inverore porae non et quia
dusdam qui a vit laboriatat et eveliberit
moluptis samus etur, quod explatibus.
Est, sus ut el esequi debis int aut offic te iur,
sum ius venim aliatiiis magnati dite ped

Billy

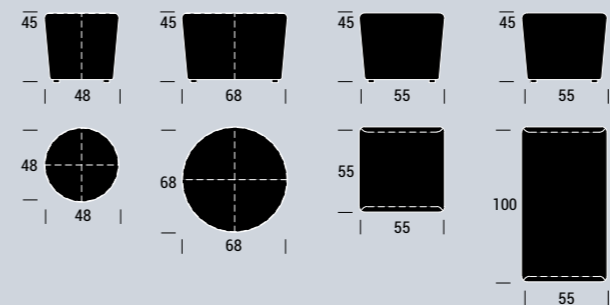

Tessuti /
Fabrics



G192 col.19
cat. elegant

Ro to eatem sinto mod qui dolum volorem
quodit doluptur ani dolor ma dolorro in
porendis es diti inulles equist voloris adia
autam escil et inverore porae non et quia
dusdam qui a vit laboriatat et eveliberit
moluptis samus etur, quod explatibus.
Est, sus ut el esequi debis int aut offic te iur,
sum ius venim aliatiiis magnati dite ped

Ro to eatem sinto mod qui dolum volorem
quodit doluptur ani dolor ma dolorro in
porendis es diti inulles equist voloris adia
autam escil et inverore porae non et quia
dusdam qui a vit laboriatat et eveliberit
moluptis samus etur, quod explatibus.
Est, sus ut el esequi debis int aut offic te iur,
sum ius venim aliatiiis magnati dite ped

Frank



Tessuti /
Fabrics



G192 col.19
cat. elegant

Ro to eatem sinto mod qui dolum volorem
quodit doluptur ani dolor ma dolorro in
porendis es diti inulles equist valoris adia
autam escil et inverore porae non et quia
dusdam qui a vit laboriatat et eveliberit
moluptis samus etur, quod explatibus.
Est, sus ut el esequi debis int aut offic te iur,
sum ius venim aliatiiis magnati dite ped

Ro to eatem sinto mod qui dolum volorem
quodit doluptur ani dolor ma dolorro in
porendis es diti inulles equist valoris adia
autam escil et inverore porae non et quia
dusdam qui a vit laboriatat et eveliberit
moluptis samus etur, quod explatibus.
Est, sus ut el esequi debis int aut offic te iur,
sum ius venim aliatiiis magnati dite ped

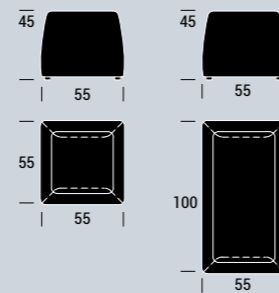

Xxxxxxx



Tavolini/ Small tables

Lorem ipsum dolor sit amet,
consectetur adipiscing
elit, sed do eiusmod tempor
incididunt ut labore
et dolore magna aliqua.

But I must explain to you
how all this mistaken idea
of denouncing pleasure
and praising pain was
born and I will give you
a complete account of the
system, and expound the
actual teachings of the
great explorer of the
truth, the master-builder
of human happiness.

117

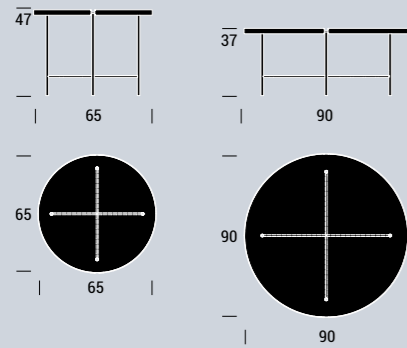

Ro to eatem sinto mod qui dolum volorem quodit doluptur ani dolor ma dolorro in porendis es diti inulles equist voloris adia autam escil et inverore porae non et quia dusdam qui a vit laboriatat et eveliberit moluptis samus etur, quod explatibus. Est, sus ut el esequi debis int aut offic te iur, sum ius venim aliatiiis magnati dite ped

Ro to eatem sinto mod qui dolum volorem quodit doluptur ani dolor ma dolorro in porendis es diti inulles equist voloris adia autam escil et inverore porae non et quia dusdam qui a vit laboriatat et eveliberit moluptis samus etur, quod explatibus. Est, sus ut el esequi debis int aut offic te iur, sum ius venim aliatiiis magnati dite ped

Finiture Finishings

Struttura in metallo
Metal frame
Di serie / Standard



Ral 9003

Ral 9016

Ral 9010

Ral 7035

Ral 9006

Ral 9005

Optional

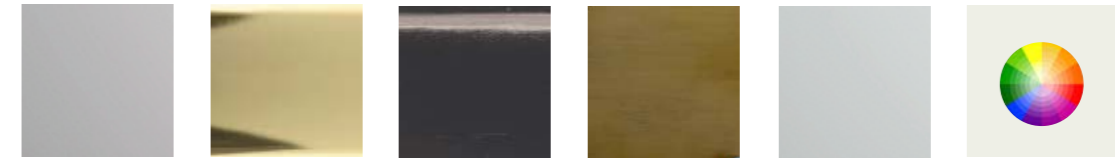

Cromato lucido
Polished plated chrome

Ottonato Lucido
Polished plated brass

Canna da fucile lucido
Polished gunmetal

Ottonato brunito lucido
Satin burnished plated brass

Cromato satinato
Satin plated chrome

Ral colore a scelta
Ral color of your choice

Piano in legno
Metal frame
Di serie / Standard

Optional



10 Wengè

01 Naturale
Natural

04 Noce chiaro
Light walnut

05 Noce
Walnut

07/20 Nero
Black

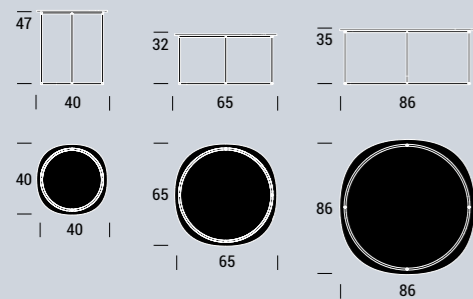

Ro to eatem sinto mod qui dolum volorem quodit doluptur ani dolor ma dolorro in porendis es diti inulles equist voloris adia autam escil et inverore porae non et quia dusdam qui a vit laboriatat et eveliberit moluptis samus etur, quod explatibus. Est, sus ut el esequi debis int aut offic te iur, sum ius venim aliatiiis magnati dite ped

Ro to eatem sinto mod qui dolum volorem quodit doluptur ani dolor ma dolorro in porendis es diti inulles equist voloris adia autam escil et inverore porae non et quia dusdam qui a vit laboriatat et eveliberit moluptis samus etur, quod explatibus. Est, sus ut el esequi debis int aut offic te iur, sum ius venim aliatiiis magnati dite ped

Finiture Finishings

Struttura in metallo
Metal frame
Di serie / Standard

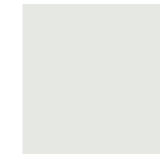

Ral 9003



Ral 9016



Ral 9010



Ral 7035



Ral 9006



Ral 9005

Optional

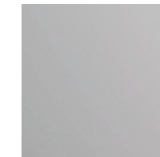

Cromato lucido
Polished plated
chrome



Ottonato Lucido
Polished plated
brass



Canna da fucile
lucido
Polished gunmetal

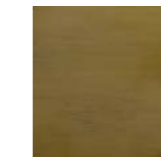

Ottonato brunito
lucido
Satin burnished
plated brass



Cromato satinato
Satin plated
chrome

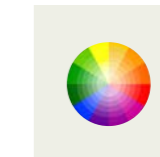

Ral colore a scelta
Ral color of your
choice



Tavolini Small tables
Domingo—Modern

Priamo

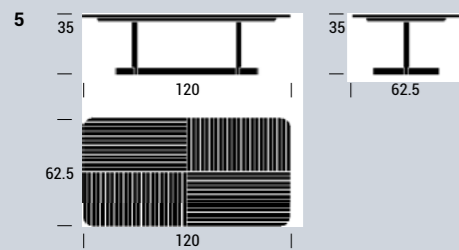
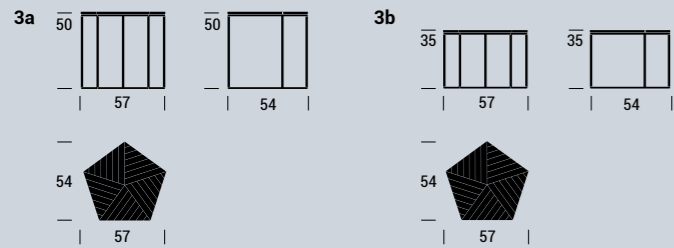
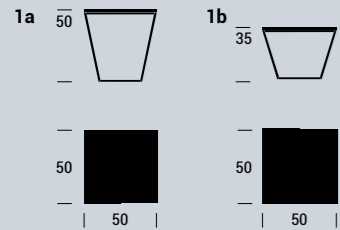

Ro to eatem sinto mod qui dolum volorem quodit doluptur ani dolor ma dolorro in porendis es diti inulles equist voloris adia autam escil et inverore porae non et quia dusdam qui a vit laboriatat et eveliberit moluptis samus etur, quod explatibus. Est, sus ut el esequi debis int aut offic te iur, sum ius venim aliatiiis magnati dite ped

Ro to eatem sinto mod qui dolum volorem quodit doluptur ani dolor ma dolorro in porendis es diti inulles equist voloris adia autam escil et inverore porae non et quia dusdam qui a vit laboriatat et eveliberit moluptis samus etur, quod explatibus. Est, sus ut el esequi debis int aut offic te iur, sum ius venim aliatiiis magnati dite ped

Finiture Finishings

Struttura in metallo
Metal frame
Di serie / Standard



Ral 9003 Ral 9016 Ral 9010 Ral 7035 Ral 9006 Ral 9005

Optional

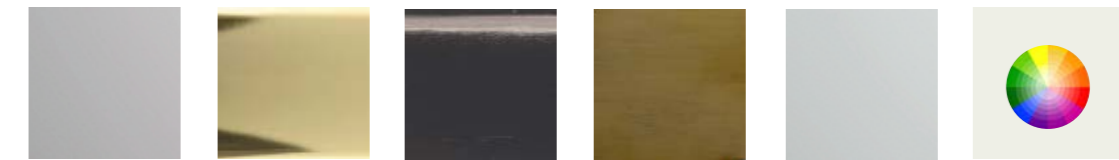

Cromato lucido
Polished plated chrome
Ottonato Lucido
Polished plated brass
Canna da fucile lucido
Polished gunmetal
Ottonato brunito lucido
Satin burnished plated brass
Cromato satinato
Satin plated chrome
Ral colore a scelta
Ral color of your choice

Piano in cemento
Concrete top



NCS-S 3500 N

Fughe
Joints

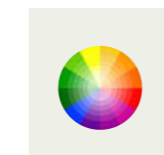

Ral colore a scelta
Ral color of your choice



Finiture Finisings

Struttura in metallo
Metal frame
Di serie / Standard

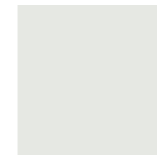

Ral 9003

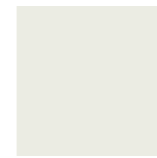

Ral 9016



Ral 9010



Ral 7035



Ral 9006



Ral 9005

Optional

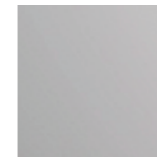

Cromato lucido
Polished plated
chrome



Ottonato Lucido
Polished plated
brass



**Canna da fucile
lucido**
Polished gunmetal



**Ottonato brunito
lucido**
Satin burnished
plated brass

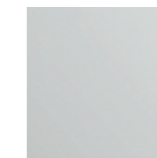

Cromato satinato
Satin plated
chrome

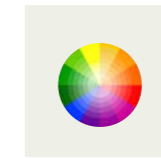

Ral colore a scelta
Ral color of your
choice

Piano in cemento
Concrete top



Ral colore a scelta
Ral color of your
choice

Ro to eatem sinto mod qui dolum volorem
quodit doluptur ani dolor ma dolorro in
porendis es diti inulles equist valoris adia
autam escil et inverore porae non et quia
dusdam qui a vit laboriatat et eveliberit
moluptis samus etur, quod explatibus.
Est, sus ut el esequi debis int aut offic te iur,
sum ius venim aliatiiis magnati dite ped

Ro to eatem sinto mod qui dolum volorem
quodit doluptur ani dolor ma dolorro in
porendis es diti inulles equist valoris adia
autam escil et inverore porae non et quia
dusdam qui a vit laboriatat et eveliberit
moluptis samus etur, quod explatibus.
Est, sus ut el esequi debis int aut offic te iur,
sum ius venim aliatiiis magnati dite ped

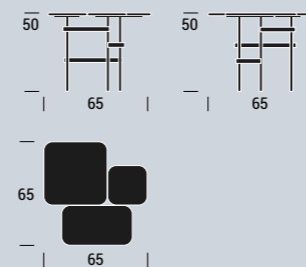

Tablette

design **Roberto Giacomucci**

Tavolini Small tables
Domingo—Modern

Tablette

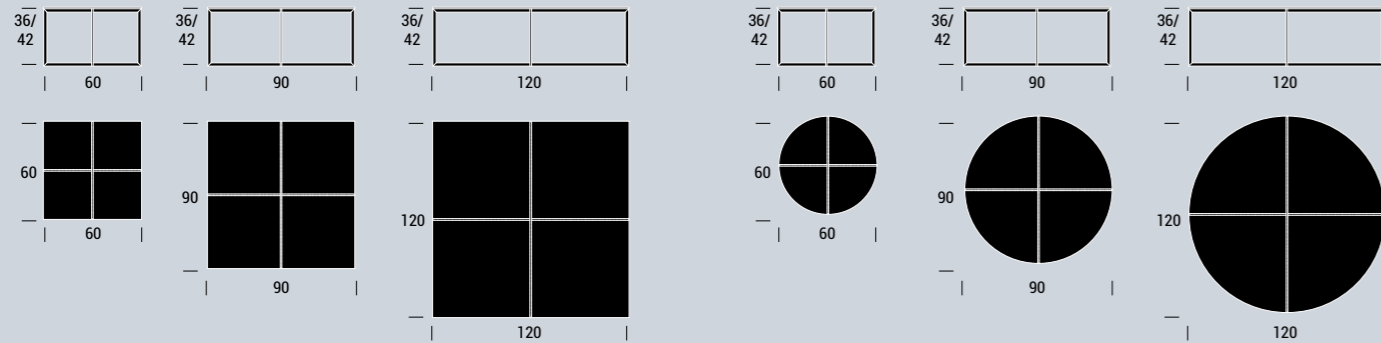

Ro to eatem sinto mod qui dolum volorem quodit doluptur ani dolor ma dolorro in porendis es diti inulles equist voloris adia autam escil et inverore porae non et quia dusdam qui a vit laboriatat et eveliberit moluptis samus etur, quod explatibus. Est, sus ut el esequi debis int aut offic te iur, sum ius venim aliatiiis magnati dite ped

Ro to eatem sinto mod qui dolum volorem quodit doluptur ani dolor ma dolorro in porendis es diti inulles equist voloris adia autam escil et inverore porae non et quia dusdam qui a vit laboriatat et eveliberit moluptis samus etur, quod explatibus. Est, sus ut el esequi debis int aut offic te iur, sum ius venim aliatiiis magnati dite ped

Warhol

Finiture Finishings

Struttura in metallo
Metal frame
Di serie / Standard

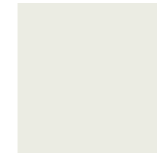

Ral 9016



Ral 9011

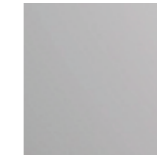

Cromato lucido
Polished plated chrome

Optional

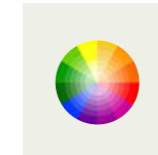

Ral colore a scelta
Ral color of your choice

Piano in vetro
Glass top
Di serie / Standard



Vetro trasparente
Trasparent glass

Optional



Vetro laccato
Ral colore a scelta
Laquered glass Ral color of your choice

Piano in marmo
marble top



Bianco Carrara



Bianco Calacatta



Cappuccino

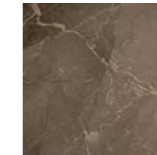

Moresco Imperiale



Noir Saint Laurent

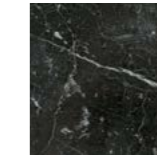

Nero Marquina

Tavolini Small tables
Domingo—Modern

Warhol

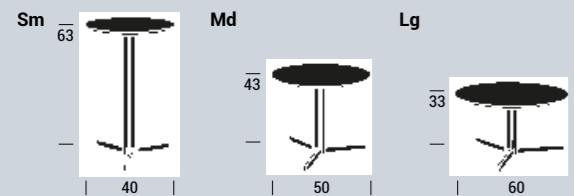

Ro to eatem sinto mod qui dolum volorem quodit doluptur ani dolor ma dolorro in porendis es diti inulles equist voloris adia autam escil et inverore porae non et quia dusdam qui a vit laboriatat et eveliberit moluptis samus etur, quod explatibus. Est, sus ut el esequi debis int aut offic te iur, sum ius venim aliatii magnati dite ped

Ro to eatem sinto mod qui dolum volorem quodit doluptur ani dolor ma dolorro in porendis es diti inulles equist voloris adia autam escil et inverore porae non et quia dusdam qui a vit laboriatat et eveliberit moluptis samus etur, quod explatibus. Est, sus ut el esequi debis int aut offic te iur, sum ius venim aliatii magnati dite ped

Finiture Finishings

Struttura in metallo
Metal frame
Di serie / Standard

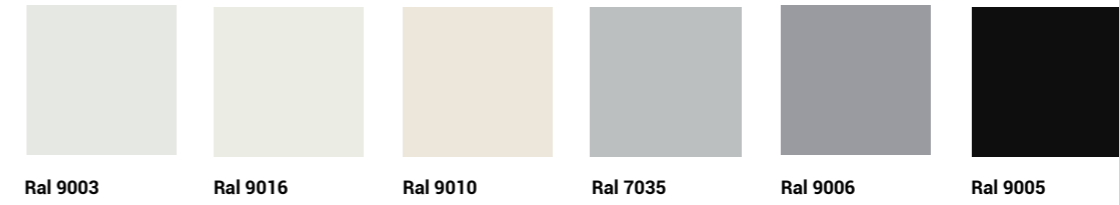

Ral 9003 Ral 9016 Ral 9010 Ral 7035 Ral 9006 Ral 9005

Optional

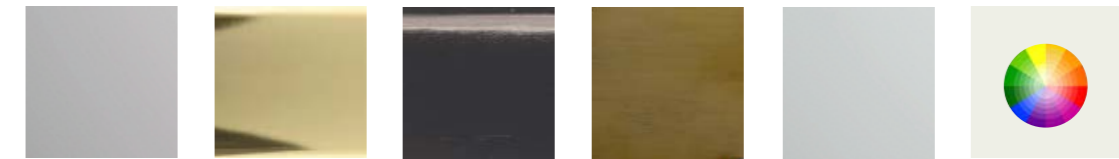

Cromato lucido Polished plated chrome
Ottonato Lucido Polished plated brass
Canna da fucile lucido Polished gunmetal
Ottonato brunito lucido Satin burnished plated brass
Cromato satinato Satin plated chrome
Ral colore a scelta Ral color of your choice

Piano in marmo
marble top

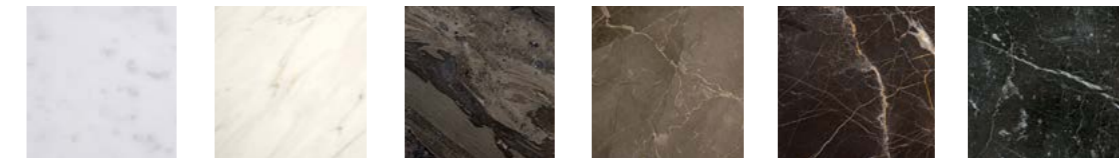

Bianco Carrara Bianco Calacatta Cappuccino Moresco Imperiale Noir Saint Laurent Nero Marquina



Tavoli/Tables

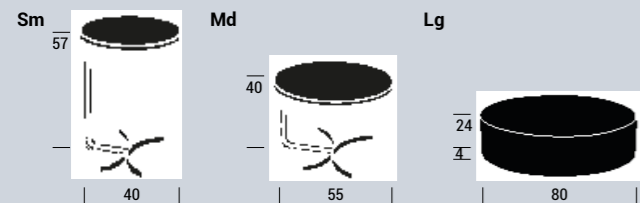

Pouf

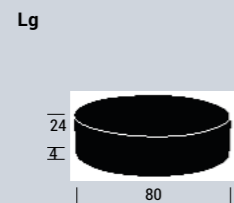

Tessuti / Fabrics



G192 col.19
cat. elegant

Ro to eatem sinto mod qui dolum volorem quodit doluptur ani dolor ma dolorro in porendis es diti inulles equist voloris adia autam escil et inverore porae non et quia dusdam qui a vit laboriatat et eveliberit moluptis samus etur, quod explatibus. Est, sus ut el esequi debis int aut offic te iur, sum ius venim aliatiiis magnati dite ped

Ro to eatem sinto mod qui dolum volorem quodit doluptur ani dolor ma dolorro in porendis es diti inulles equist voloris adia autam escil et inverore porae non et quia dusdam qui a vit laboriatat et eveliberit moluptis samus etur, quod explatibus. Est, sus ut el esequi debis int aut offic te iur, sum ius venim aliatiiis magnati dite ped

Febe

Finiture Finishings

Struttura in metallo
Metal frame
Di serie / Standard



Ral 9003 Ral 9016 Ral 9010 Ral 7035 Ral 9006 Ral 9005

Optional

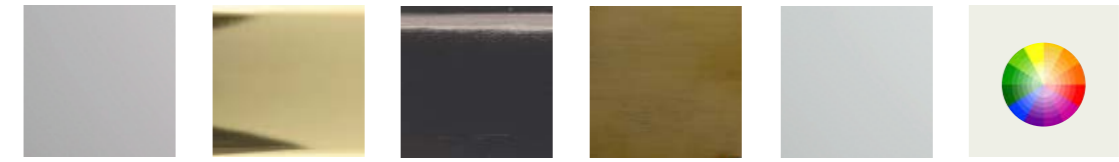

Cromato lucido
Polished plated chrome

Ottonato Lucido
Polished plated brass

Canna da fucile lucido
Polished gunmetal

Ottonato brunito lucido
Satin burnished plated brass

Cromato satinato
Satin plated chrome

Ral colore a scelta
Ral color of your choice

Piano in marmo
Marble top

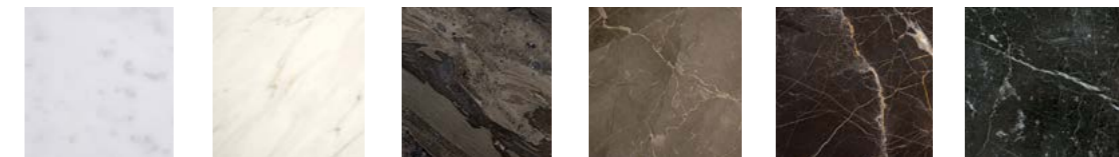

Bianco Carrara Bianco Calacatta Cappuccino Moresco Imperiale Noir Saint Laurent Nero Marquina

Piano in ceramica
Ceramic top



Breccia Gris Noisette Emperador Sahara noir



POUF H 4
Zoccolo multistrato laminato nero
Plinth in black laminated plywood

Tavolini Small tables
Domingo—Modern

Febe

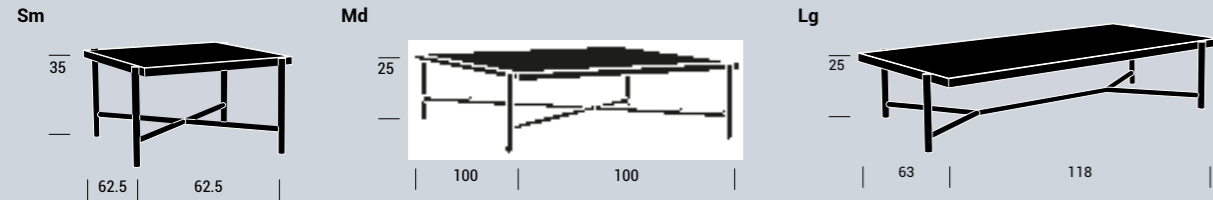

Ro to eatem sinto mod qui dolum volorem quodit doluptur ani dolor ma dolorro in porendis es diti inulles equist voloris adia autam escil et inverore porae non et quia dusdam qui a vit laboriatat et eveliberit moluptis samus etur, quod explatibus. Est, sus ut el esequi debis int aut offic te iur, sum ius venim aliatiiis magnati dite ped

Ro to eatem sinto mod qui dolum volorem quodit doluptur ani dolor ma dolorro in porendis es diti inulles equist voloris adia autam escil et inverore porae non et quia dusdam qui a vit laboriatat et eveliberit moluptis samus etur, quod explatibus. Est, sus ut el esequi debis int aut offic te iur, sum ius venim aliatiiis magnati dite ped

Rea

Finiture Finishings

Struttura in metallo
Metal frame
Di serie / Standard

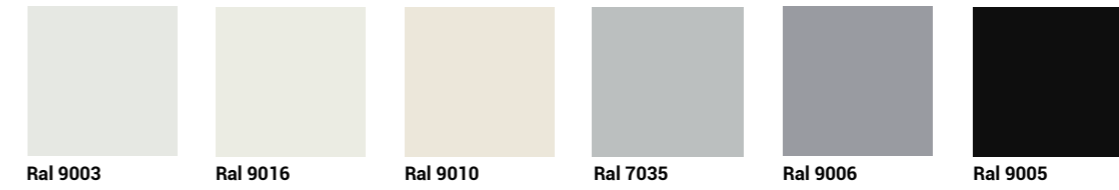

Piano in marmo
Marble top

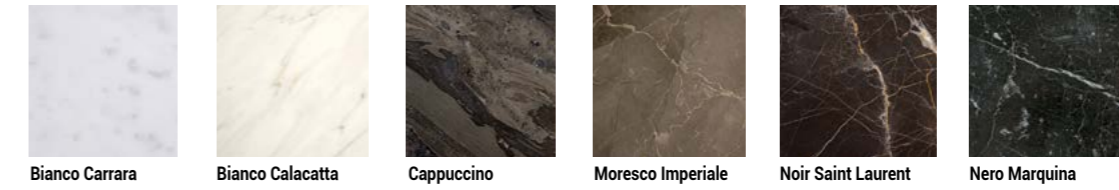

Piano in ceramica
Ceramic top



Tavolini Small tables
Domingo—Modern

Rea

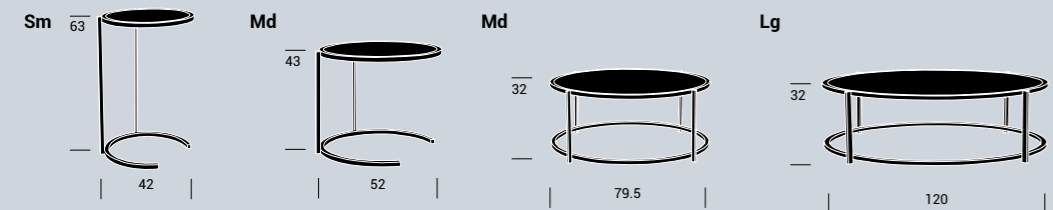

Ro to eatem sinto mod qui dolum volorem quodit doluptur ani dolor ma dolorro in porendis es diti inulles equist voloris adia autam escil et inverore porae non et quia dusdam qui a vit laboriatat et eveliberit moluptis samus etur, quod explatibus. Est, sus ut el esequi debis int aut offic te iur, sum ius venim aliatiiis magnati dite ped

Ro to eatem sinto mod qui dolum volorem quodit doluptur ani dolor ma dolorro in porendis es diti inulles equist voloris adia autam escil et inverore porae non et quia dusdam qui a vit laboriatat et eveliberit moluptis samus etur, quod explatibus. Est, sus ut el esequi debis int aut offic te iur, sum ius venim aliatiiis magnati dite ped

Finiture Finishings

Struttura in metallo
Metal frame
Di serie / Standard

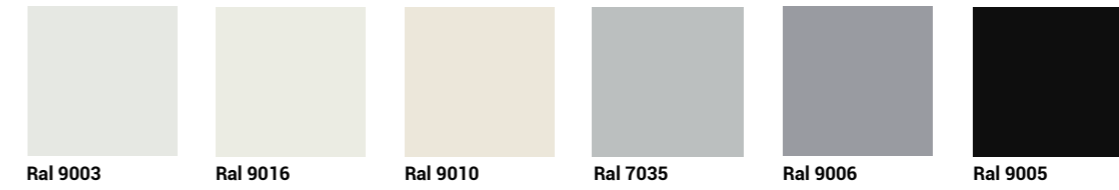

Piano in marmo
Marble top

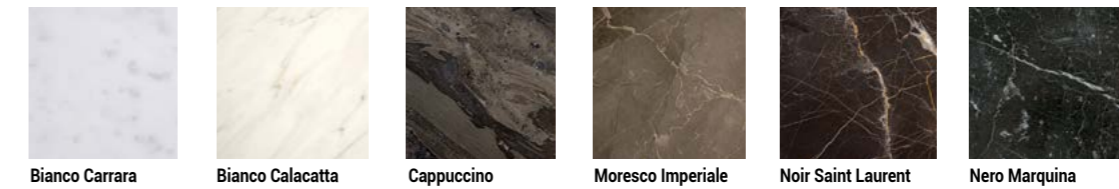

Piano in ceramica
Ceramic top



DOMINGO®

Strada della Romagna, 285
61121 PESARO (ITALY)
T +39 0721 208080
info@domingo.it
www.domingo.it

Direzione artistica Art direction	Valentina Bigiarini & Francesca Grassi
Grafica Graphic design	ma:design Pesaro
Foto Photo	Mauro Foli Cervia
Render	Roccadadria INDUSTRIAL DESIGN
Stampa Print	Xxxx xxxxx
Edizione 1 Issue 1	Giugno 2022 June 2022

Diritti riservati. La riproduzione anche parziale è consentita solo previa autorizzazione scritta di Domingo Salotti s.r.l.
All rights reserved. No parts of this catalogue may be reproduced without permission in writing from Domingo Salotti s.r.l.

Contemporary living

domingo.it