



# HENRI



Henri è una collezione di sedute modulari componibili con estrema intuitività. Gli elementi di questa linea rendono la zona giorno accogliente adatta alle esigenze di chi la vive.

È un divano basso ignifugo completamente personalizzabile ed estremamente funzionale, poiché all'occorrenza può diventare un comodo divano letto. Disponibile in più soluzioni e dimensioni, nello specifico caso della chaise-longue offre un grande e pratico contenitore portaoggetti.

- 1 - nella seduta e materassina in piuma, nello schienale piuma;
- 2 - poliuretano espanso indeformabile di diverse densità;
- 3 - telaio in agglomerato di legno;
- 4 - piedi in legno tinto noce, ciliegio o wengè.
- 5 - cinghie elastiche intrecciate.

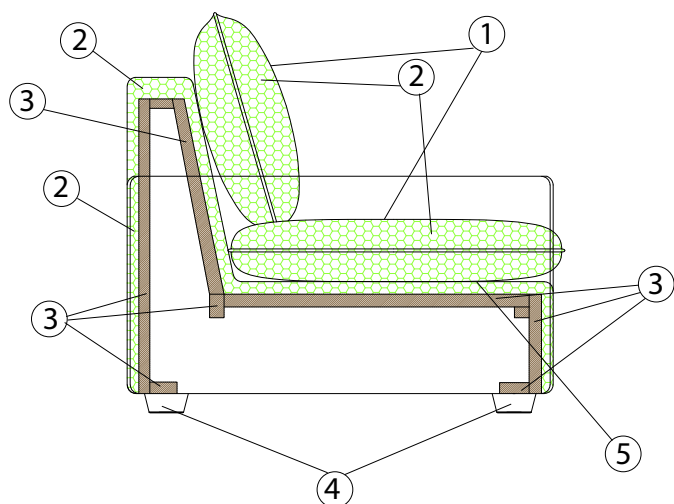

## DIMENSIONI

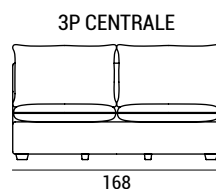
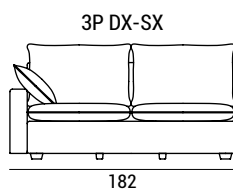
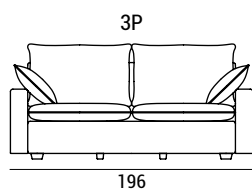
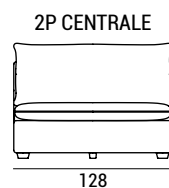
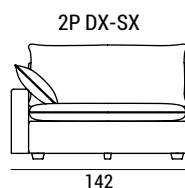
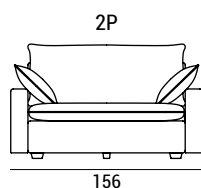
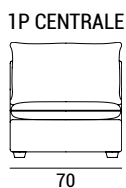
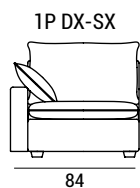
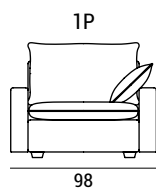
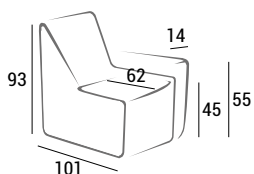



# HENRI

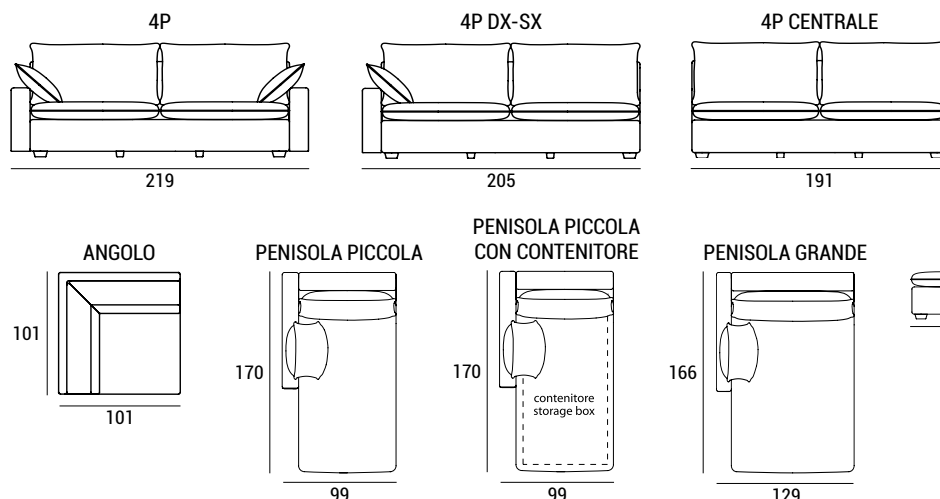

## LETTO OPTIONAL

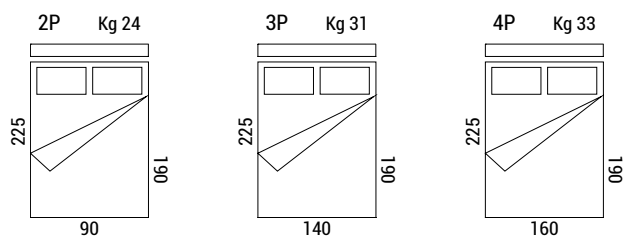

Materasso in poliuretano espanso a due pieghe, normale o ignifugo, h 12 cm, rivestito con tessuto anallergico composto da poliestere.  
Rete elettrosaldata di acciaio ad alta resistenza.

## MECCANISMO LETTO

### Apertura

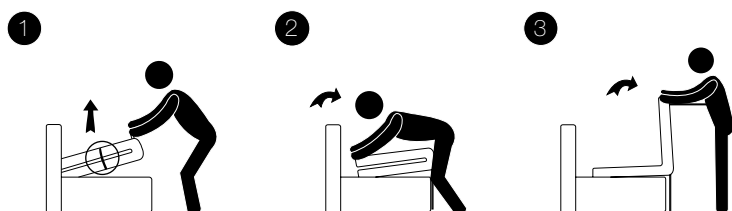

RIMUOVERE le fascette ai lati prima di sollevare la rete

Un'errata apertura del letto può provocare la rottura del meccanismo

### Chiusura

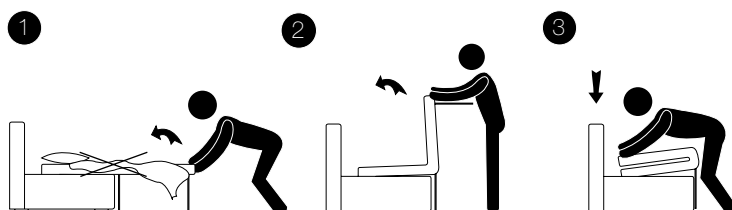

RIMUOVERE lenzuola, coperte o cuscini prima della chiusura del letto per evitare danni al meccanismo

## PIEDI

P 07





h 4.5-6-8



# HENRI

## INFORMAZIONI TECNICHE

			 tessuto mtl H 140 cm	
			sopra	sotto
HENRI 1P	50	0.92	3.80	4.70
HENRI 1P DX-SX	42	0.79	3.10	3.50
HENRI 1P CENTRALE	38	0.66	2.40	2.30
HENRI 2P	55	1.47	4.20	5.40
HENRI 2P DX-SX	47	1.33	3.50	4.20
HENRI 2P CENTRALE	43	1.20	2.80	3.00
HENRI 3P	80	1.84	6.10	6.60
HENRI 3P DX-SX	72	1.71	5.40	5.40
HENRI 3P CENTRALE	68	1.58	4.70	4.20
HENRI 4P	85	2.06	6.50	6.90
HENRI 4P DX-SX	77	1.93	5.80	5.70
HENRI 4P CENTRALE	73	1.79	5.10	4.50
HENRI ANGOLO	38	0.95	3.80	3.80
HENRI PENISOLA PICCOLA DX-SX	55	1.53	3.50	3.70
HENRI PENISOLA PICCOLA CON CONT. DX-SX	65	1.53	3.50	3.70
HENRI PENISOLA GRANDE DX-SX	63	1.99	4.10	4.30
HENRI POUF	15	0.46	2.00	1.50