

.detail6  
the new contemporary

news 2019









# butterfly

Le gambe in legno di Butterfly combinano un design leggero, lieve e delicato, con la solida dolcezza del legno curvato. Esattamente come le farfalle, i colori cambiano quasi infiniti, nelle varianti di vetro temperato, gres porcellanato, marmo e legno. Potrete trasformare le vostre stanze con la grazia di una farfalla.

Butterfly's wooden legs combine a light, mild and delicate design, with curved wood's solid sweetness. Like butterflies, colors change almost infinitely, from the tempered glass finishes, through porcelain, marble and up to wood. You can transform your room, as gracefully as a butterfly.

## 8070FSV

(T) Ø 160 H 75 cm  
(P) L 133 P 133 H 75 cm  
(A) L 200 P 106 H 75 cm  
(G) L 250 P 106 H 75 cm  
(Z) L 300 P 120 H 75 cm

## 8070FSL

(LP) L 133 P 133 H 75 cm  
(LA) L 200 P 100 H 75 cm  
(LG) L 250 P 120 H 75 cm  
(LZ) L 300 P 120 H 75 cm

## 8070FSM

(T) Ø 160 H 75 cm  
(P) L 133 P 133 H 75 cm  
(A) L 200 P 106 H 75 cm  
(G) L 250 P 106 H 75 cm

## 8070FSC

(P) L 133 P 133 H 75 cm  
(A) L 200 P 106 H 75 cm  
(G) L 250 P 106 H 75 cm  
(Z) L 300 P 120 H 75 cm

## 8070FV

(FP) L 160 P 90 H 75 cm  
(FA) L 180 P 90 H 75 cm  
(FG) L 200 P 100 H 75 cm

## 8070

(P) L 160/240 P 90 H 75 cm  
(A) L 180/260 P 90 H 75 cm  
(G) L 200/300 P 100 H 75 cm

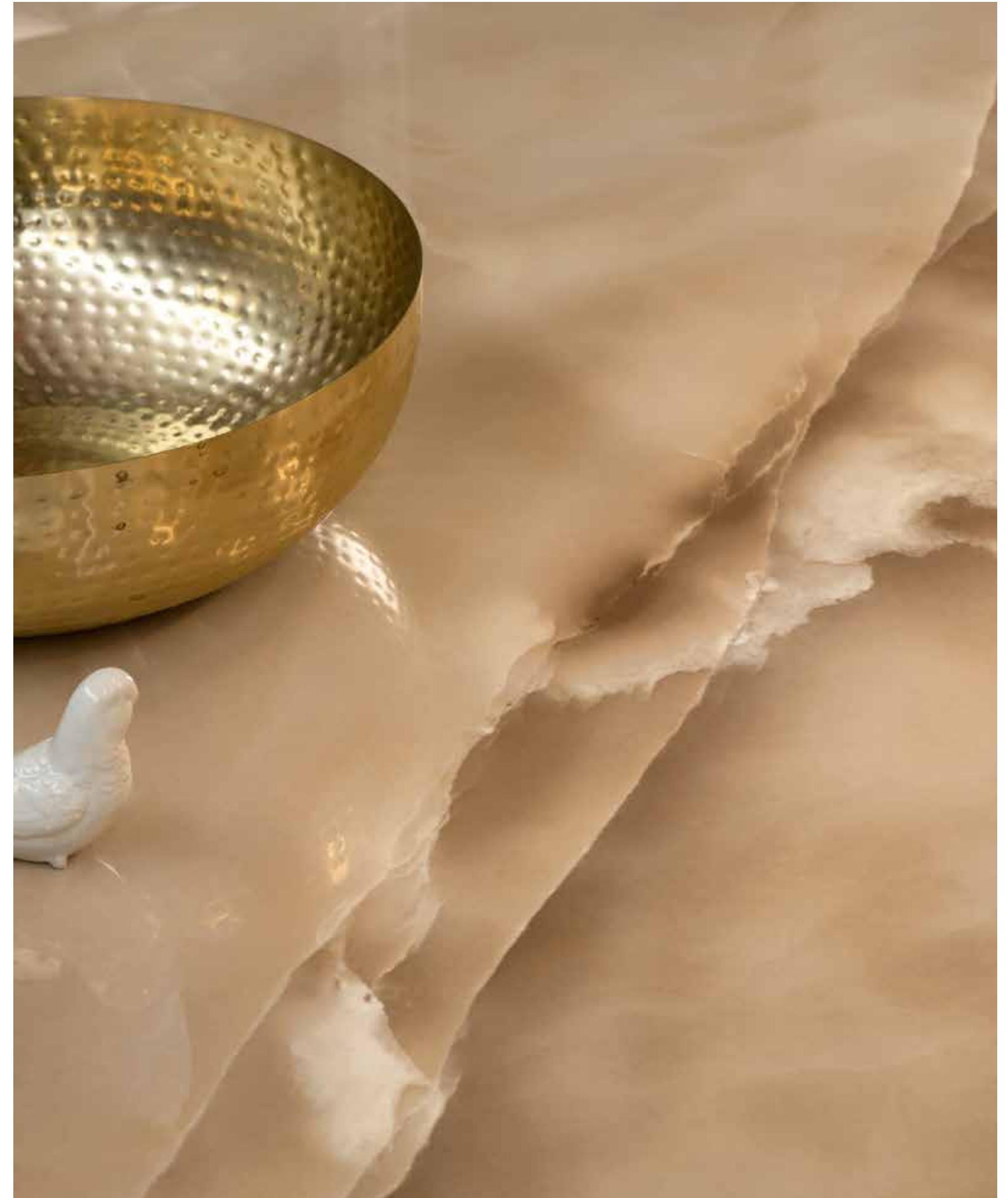

Tavolo allungabile con base noce canaletto, binario in alluminio laccato grigio carbone, piano e allunghe in gres porcellanato Onice ambra.

Extendible table with Canaletto walnut base, guide bar in carbon grey lacquered aluminum, top and extensions in Onyx amber porcelain stoneware.





# calliope

Tavolo fisso con base in finitura brushed bronzo e piano in vetro trasparente extra chiaro sagomato profilo raggiato.

*Fixed table with base in brushed bronze finish and top in shaped extra-clear transparent glass with rounded profile.*

Dopo la versione allungabile, Calliope si reinventa nella nuova versione fissa e si arricchisce di una laccatura spazzolata. I particolari fanno sempre la differenza e Calliope ne è l'esempio.

After the extendible version, Calliope reinvents itself in the new fixed version and is enriched with a brushed lacquer. Calliope is the example on how the details always make the difference.

8099FS

(A) L 180 P 100 H 75 cm  
(G) L 215 P 100 H 75 cm  
(H) L 250 P 120 H 75 cm

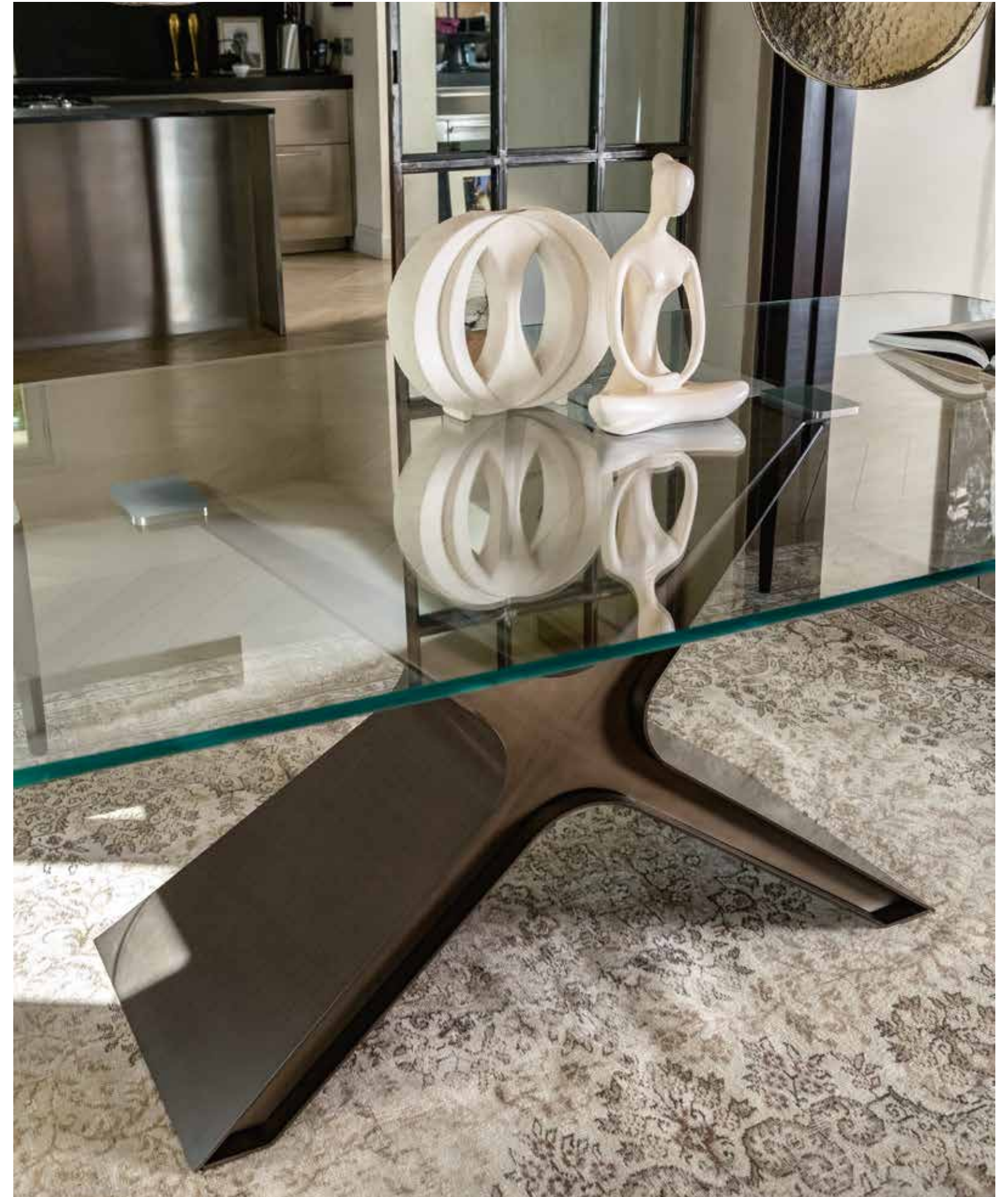



Tavolo fisso con base in finitura brushed bronzo e piano in gres porcellanato Emperor.  
*Fixed table with brushed bronze finish base and Emperor porcelain stoneware top.*





Tavolo fisso con base in finitura brushed bronzo e piano in gres porcellanato Onice ambr.  
Fixed table with brushed bronze finish base and Onyx amber porcelain stoneware top.

Tavolo fisso con base laccata testa di moro,  
inserti in legno noce canaletto e piano in gres  
porcellanato Emperador.  
*Fixed table with dark brown lacquered base,  
Canaletto walnut wood inserts and Emperador  
porcelain stoneware top.*



dolly

Tavolo fisso con base in agglomerato di marmo laccato e piano in legno con inserto in vetro o gres porcellanato. Disponibile anche con vassoio centrale Lazy Susan. Aggiungi un posto a tavola che arriva Dolly.

Fixed table with lacquered marble agglomerate base and wooden top with glass or porcelain stoneware insert. Also available with Lazy Susan center tray. Add another place at the table that comes Dolly.

8095FS

(P) Ø 160 H 75 cm  
(A) Ø 180 H 75 cm  
(G) Ø 200 H 75 cm

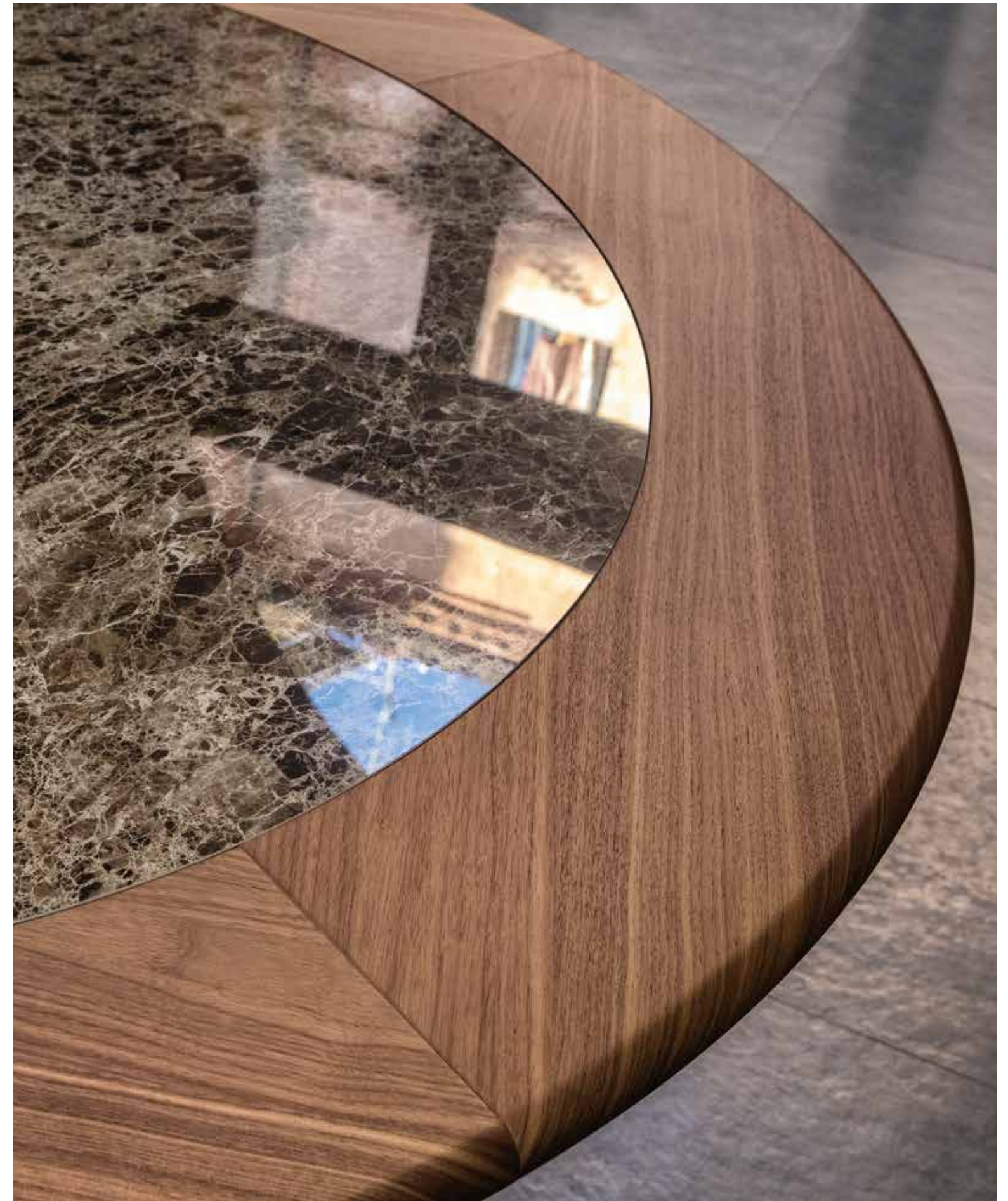

Tavolo fisso con base laccata testa di moro, inserti in legno frassino nero e piano in gres porcellanato Onice ambra.  
Fixed table with dark brown lacquered base, black ash wood inserts and Onyx amber porcelain stoneware top.



# pandora table

Una struttura multi materica caratterizzata da vero marmo, vetro fuso e legno tornito laccato. Un grande valore estetico dettato dalla matericità degli elementi che sono parte integrante di questo tavolo. Disponibile in più essenze e con Lazy Susan.

A multi-material structure characterized by real marble, fused glass and lacquered turned wood. A great aesthetic value dictated by the materiality of the elements that are an integral part of this table. Available in multiple essences and with Lazy Susan.



8096FS

Ø 160 H 75 cm

design by\_Tosca Design

Tavolo fisso con base e componenti in marmo Port Saint laurent, vetro fuso ambra, legno laccato nero lucido e particolari in finitura oro. Piano e Lazy Susan in noce canaletto.

Fixed table with base and components in Port Saint Laurent marble, amber fused glass, glossy black lacquered wood and details in gold finish. Top and Lazy Susan in Canaletto walnut.

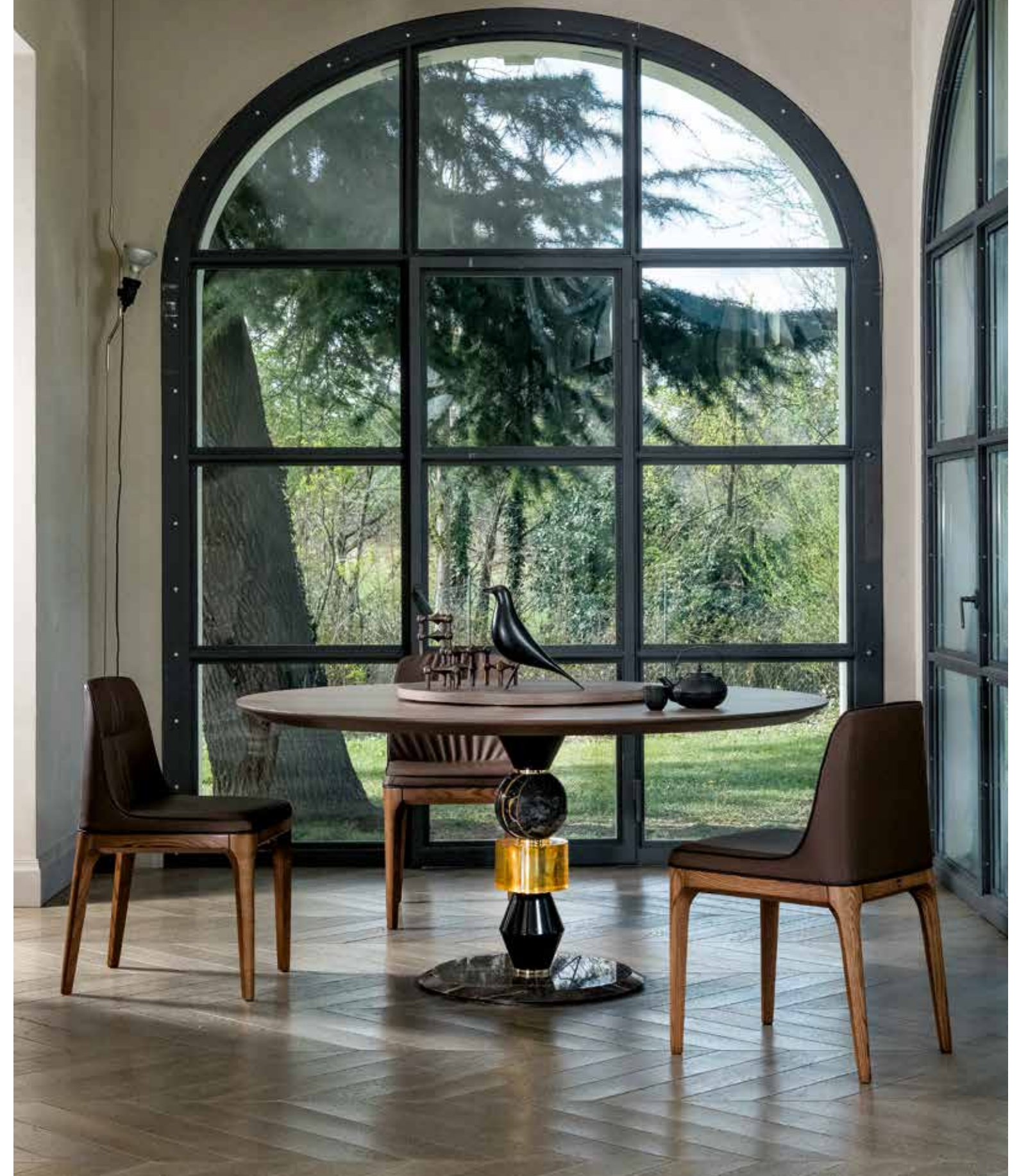

Tavolo fisso con base e componenti in marmo nero Marquinia, vetro fuso fumè, legno laccato nero lucido e particolari in finitura oro. Piano e Lazy Susan in rovere scuro termotrattato.

Fixed table with base and components in black Marquinia marble, fumè fused glass, glossy black lacquered wood and details in gold finish. Top and Lazy Susan in heat-treated dark oak.



## reverse

Un tavolo reversibile perfetto per ogni occasione. Una base in acciaio verniciato con piani in vetro disponibili in diverse finiture. Scegli la forma che più ti si addice e crea la tua sala da pranzo.

A perfect reversible table for any occasion. A base in painted steel with glass tops available in different finishes. Choose the one that suits you best and create your own living room.

8094FS

(FA) L 180 P 90 H 75 cm  
(FG) L 200 P 100 H 75 cm  
(RZ) L 240 P 110 H 75 cm





Tavolo fisso con base grigio carbone e piano in vetro nero martellato.  
*Fixed table with carbon grey base and hammered black glass top.*





Tavolo fisso con base brushed bronzo e piano in vetro trasparente extra chiaro.  
*Fixed table with brushed bronze base and extra-clear transparent glass top.*



Tavolo fisso con base brushed bronzo e piano in vetro trasparente extra chiaro.  
*Fixed table with brushed bronze base and extra-clear transparent glass top.*

Tavolo fisso con base brushed bronzo e piano in gres porcellanato Portoro.  
Fixed table with brushed bronze base and Portoro porcelain stoneware top.



Tavolo fisso con base brushed bronzo e piano in gres porcellanato Emperor.  
Fixed table with brushed bronze base and Emperor porcelain stoneware top.



# still

Tavolo fisso o allungabile con base in legno termocurvato, pensata per essere abbinata ad eleganti piani in vetro o gres porcellanato. Le linee più semplici possono essere le più eleganti e senza tempo.

Fixed or extendible table with thermocurved wood base, designed to be combined with elegant glass or porcelain stoneware tops. The simplest lines can be the most elegant and the most timeless ones.

## 8093AV

(P) L 150/230 P 100 H 75 cm  
(A) L 180/260 P 100 H 75 cm  
(G) L 215/295 P 100 H 75 cm

## 8093FS

(P) L 150 P 100 H 75 cm  
(A) L 180 P 100 H 75 cm  
(G) L 215 P 100 H 75 cm  
(Z) L 295 P 100 H 75 cm  
(H) L 300 P 120 H 75 cm

## 8103AV

(P) L 160/240 P 90 H 75 cm  
(A) L 180/260 P 90 H 75 cm  
(G) L 200/300 P 100 H 75 cm



Tavolo allungabile con base noce canaletto, binario in alluminio laccato grigio carbone, piano e allunghe in gres porcellanato onice grigio.  
Extendible table with Canaletto walnut base, guide bar in carbon grey lacquered aluminum, top and extensions in Onyx grey porcelain stoneware.





Tavolo allungabile con base noce canaletto, binario in alluminio laccato grigio carbone, piano e allunghe in vetro ceramicato nero.  
Extendible table with Canaletto walnut base, guide bar in carbon grey lacquered aluminum, top and extensions in black ceramic glass.





Tavolo allungabile con base noce canaletto, binario in alluminio laccato grigio carbone, piano e allunghe in vetro ceramicato nero.  
*Extendible table with Canaletto walnut base, guide bar in carbon grey lacquered aluminum, top and extensions in black ceramic glass.*

Tavolo fisso con base rovere scuro termotrattato e piano in vetro trasparente extra chiaro sagomato.  
*Fixed table with dark oak heat-treated base and shaped extra-clear transparent glass top.*



Tavolo fisso con base rovere scuro termotrattato e piano in gres porcellanato Emperador.  
Fixed table with dark oak heat-treated base and Emperador porcelain stoneware top.



# york

Un tavolo tondo con base in legno massiccio dal tono geometrico deciso per chi ama osare con eleganza.

A round table with a solid wood base with a geometric tone for those who love to dare with elegance.



8097FS

(T) Ø 140 H 75 cm  
(P) Ø 160 H 75 cm  
(A) Ø 180 H 75 cm

design by\_Piervittorio Prevedello

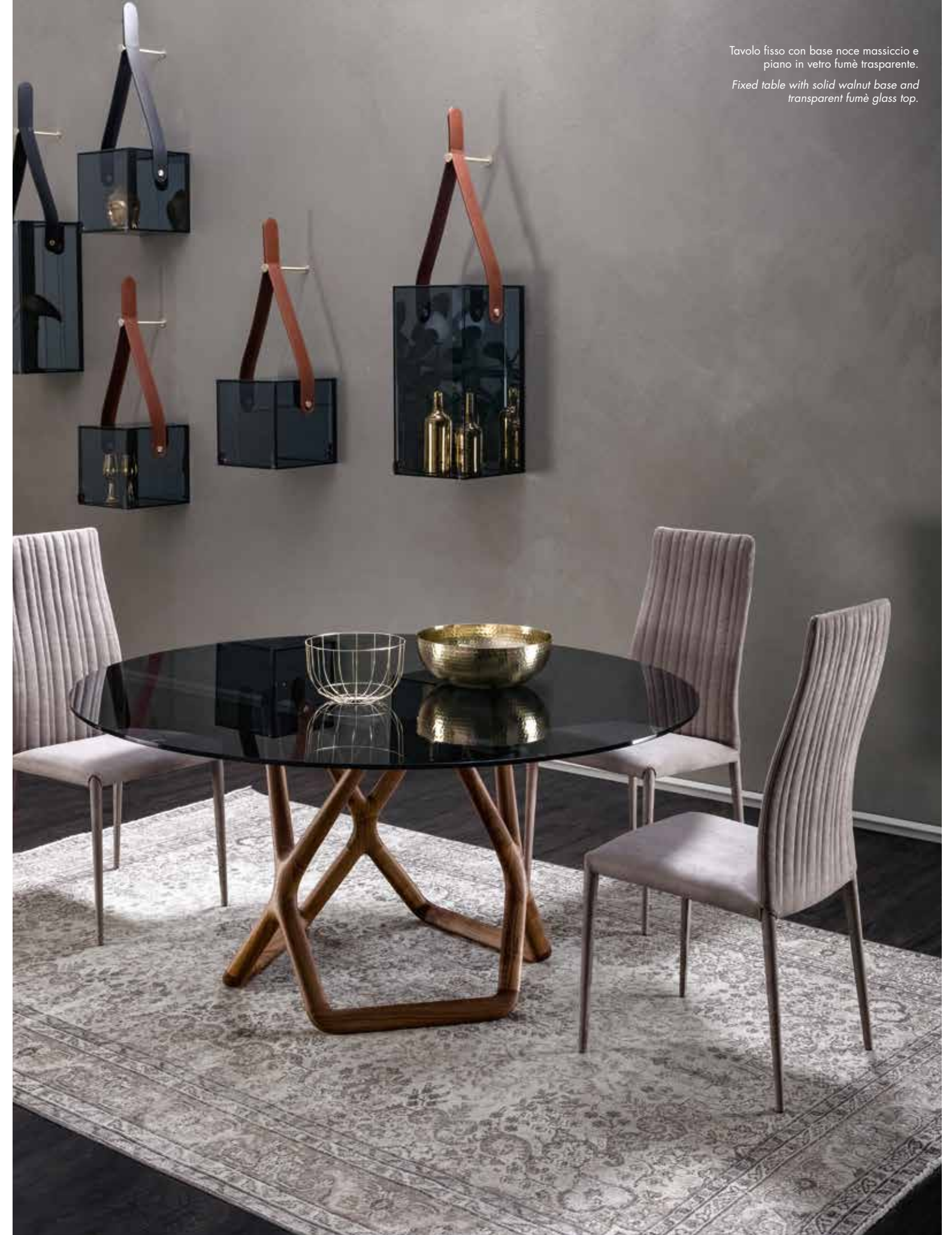

Tavolo fisso con base noce massiccio e piano in vetro fumè trasparente.  
Fixed table with solid walnut base and transparent fumè glass top.





Sedia in finitura noce canaletto e rivestimento in ecopelle nabuk ecrù.  
Chair in Canaletto walnut finishing and covering in ecru nabuk eco-leather.

agata

Un'elegante sedia disponibile anche nella versione poltroncina con base in metallo o legno. Una versione più leggera che si abbina ai nostri tavoli con grande stile.

An elegant chair also available in the armchair version with metal or wooden base. A lighter version that matches our tables with great style.

7290

L 49 P 54 H 49/80 cm

7291

L 55 P 59 H 50/79 cm

7292

L 49 P 50 H 70/93 cm



Poltroncina in metallo bronzo pietra e rivestimento in ecopelle nabuk nocciola.  
Armchair in bronze stone metal and covering in hazel nabuk eco-leather.

design by\_Luca Signoretti

Poltroncina in finitura noce canaletto e rivestimento in pelle panna.  
*Armchair in Canaletto walnut finishing and covering in cream leather.*



alexia





Sedia in finitura rovere scuro termotrattato e rivestimento in pelle marrone chiaro.  
*Chair in heat-treated dark oak finishing and covering in light brown leather.*



Sedia in metallo grigio carbone e rivestimento in pelle panna.  
 Chair in carbon grey metal and covering in cream leather.

Un'imbottitura confortevole per chi ama la comodità più assoluta. Sedia o poltroncina con base in metallo o legno da personalizzare con tutte le nostre finiture di rivestimento.

A comfortable padding for those who love absolute comfort. Chair or armchair with metal or wood base to customize with all our covering finishes.

7345

L 51 P 54 H 49/80 cm

7346

L 64 P 59 H 50/79 cm

7347

L 49 P 50 H 70/93 cm

## charm élite

Sedia con imbottitura in gomma ad alta densità per un effetto confortevole e durevole nel tempo. Da oggi Charm si veste con un nuovo concept di artigianalità, dettato da una elegante trapuntatura sullo schienale.

Chair with high density rubber padding for a comfortable and long-lasting effect. From today Charm dresses up with a new concept of craftsmanship, dictated by an elegant rhombus pattern on the backrest.

7216A

L 44 P 52 H 49/97 cm



Sedia interamente rivestita in pelle grigio.  
Chair completely covered in grey leather.

Sedia in frassino nero e rivestimento in ecopelle nabuk panna.  
Chair in black ash and covering in cream nabuk eco-leather.

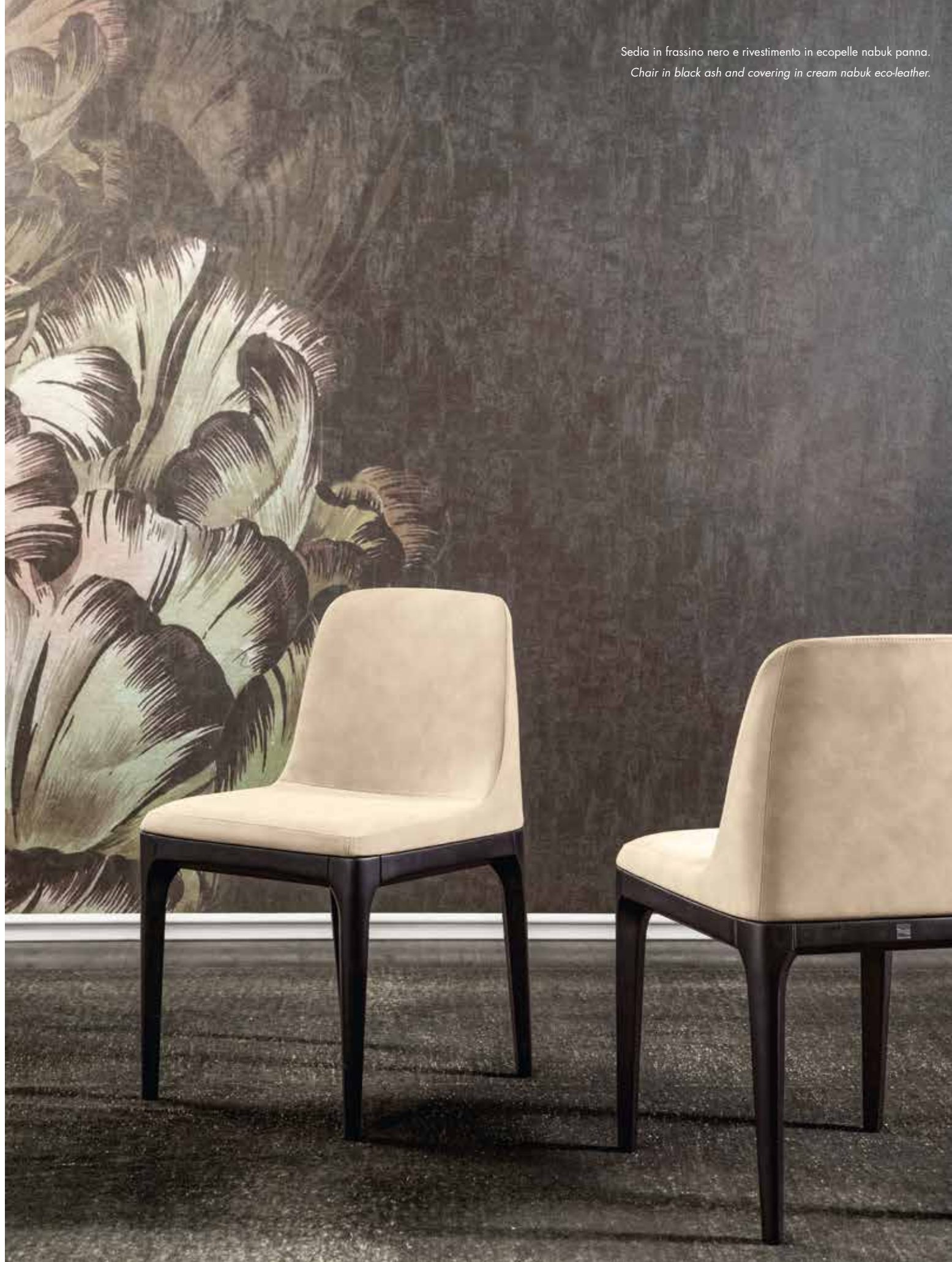

**gilda**

Seduta realizzata in poliuretano schiumato a freddo per un prodotto raffinato e senza tempo. Base in legno disponibile in diverse essenze. Scegli l'abbinata giusta per il tuo living.

Seat made of cold-foamed polyurethane for a refined and timeless product. Wooden base available in different essences. Choose the right combination for your living room.



7254

L 48 P 55 H 46/80 cm

7255

L 65 P 58 H 46/80 cm

design by\_Angelo Tomaiuolo

News 2019

Sedia interamente rivestita in pelle nabuk fango con lavorazione "cannette".  
Chair entirely covered in mud nabuk leather with "cannette" decoration.



## josefine

Sedia con imbottitura in gomma ad alta densità per un effetto confortevole e durevole nel tempo, arricchita di un'elegante lavorazione "cannette" per dare un tocco di tridimensionalità in più.

Chair with high density rubber padding for a comfortable and long-lasting effect, enriched with an elegant "cannette" processing to give an extra touch of three-dimensionality.

7287

L 46 P 55 H 47/105 cm

# malva élite

Una seduta esile ed estremamente elegante che acquisisce ulteriore valore grazie all'aggiunta della nuova trapuntatura a rombi apportata nello schienale. Sceglila con la finitura che più ti si addice.

A slim and extremely elegant seat that acquires additional value thanks to the addition of the new rhombus pattern made in the backrest. Choose it with the finish that best suits you.



7221A  
L 47 P 56 H 46/83 cm

design by\_Andrea Lucatello

Sedia in finitura noce canaletto e rivestimento in pelle grigio.  
Chair in Canaletto walnut finishing and covering in grey leather.



75

# mama

Una collezione decisamente avvolgente che si compone di una sedia, due poltrone ed un divano dal design accattivante e ricercato. L'uso e la combinazione delle migliori pelli e tessuti vestono questa famiglia di sedute massima espressione del Made in Italy.

A clearly enchanting collection that consists of a chair, two armchairs and a sofa with an attractive and refined design. The use and combination of the best leathers and fabrics cover this family of seats: the maximum expression of Made in Italy.

7239

L 61 P 63 H 97 cm

7344

(S) L 175 P 90 H 85 cm  
(B) L 220 P 91 H 85 cm

7342

L 81 P 79 H 85 cm

7343

L 81 P 85 H 109 cm

Sedia interamente rivestita in pelle nabuk testa di moro.  
Chair completely covered in dark brown nabuk leather.



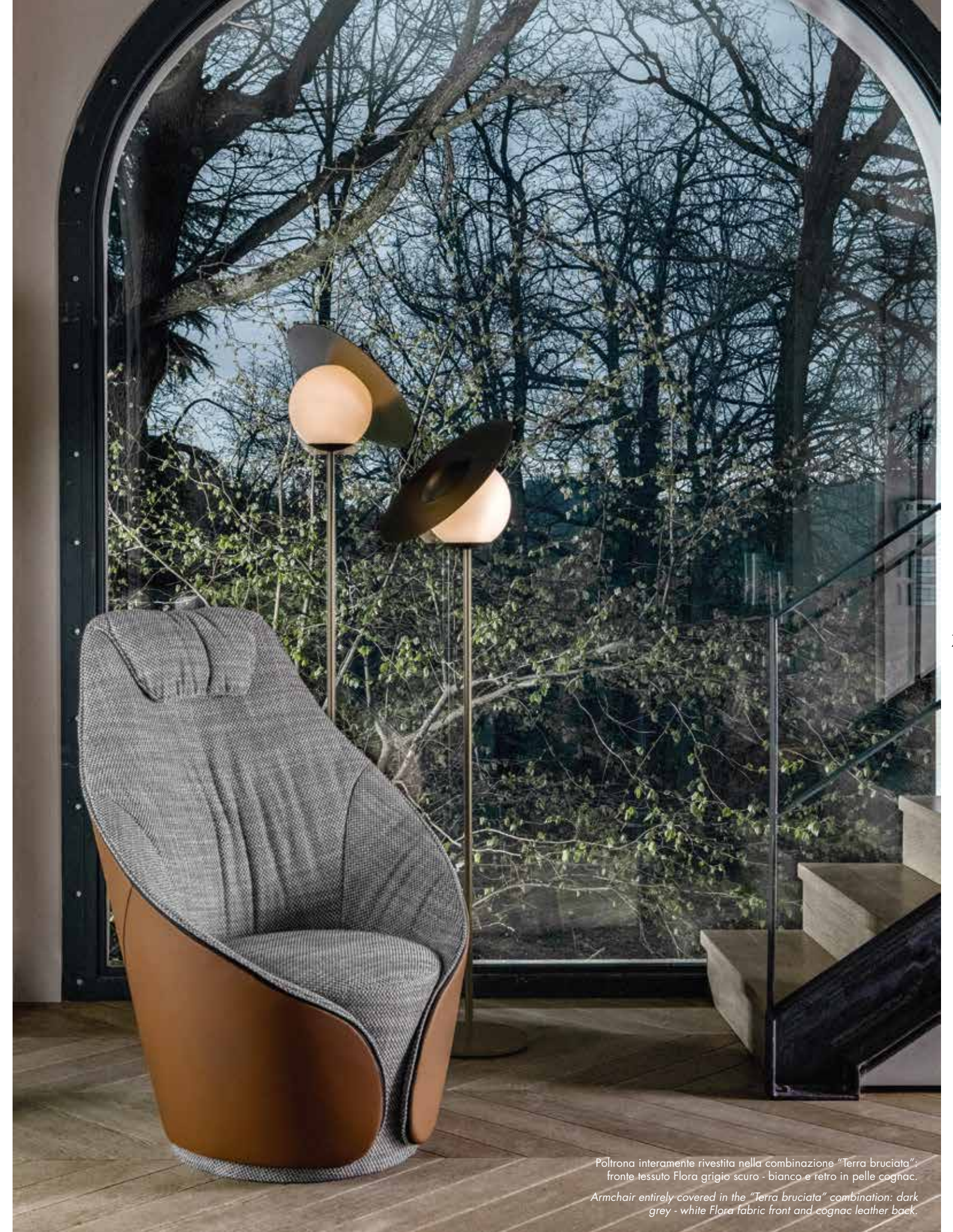

Poltrona interamente rivestita nella combinazione "Terra bruciata":  
fronte tessuto Flora grigio scuro - bianco e retro in pelle cognac.  
Armchair entirely covered in the "Terra bruciata" combination: dark  
grey - white Flora fabric front and cognac leather back.



Divano interamente rivestito nella combinazione "Terra bruciata":  
fronte tessuto Flora grigio scuro - bianco e retro in pelle cognac.  
Sofa entirely covered in the "Terra bruciata" combination: dark  
grey - white Flora fabric front and cognac leather back.



Poltrona interamente rivestita nella combinazione Grigio intenso:  
fronte tessuto Flora marrone - beige e retro in pelle grigio.  
*Armchair entirely covered in the "Grigio intenso" combination:  
brown - beige Flora fabric front and grey leather back.*



Sedia imbottita e rivestita in pelle fiore sabbia e struttura in finitura rovere scuro.  
*Padded chair covered in sand grain leather and structure in dark oak finishing.*

## sorrento easy

La nostra sedia Sorrento si veste con un nuovo abito.  
Scopri-la nella versione senza bordino e realizzata con  
una nuova elegante cucitura.

Our Sorrento chair dresses up with a new dress.  
Discover it in the version without creasing and made with  
a new elegant seam.

7284

L 50 P 65 H 47/96 cm

7285

L 63 P 65 H 47/96 cm

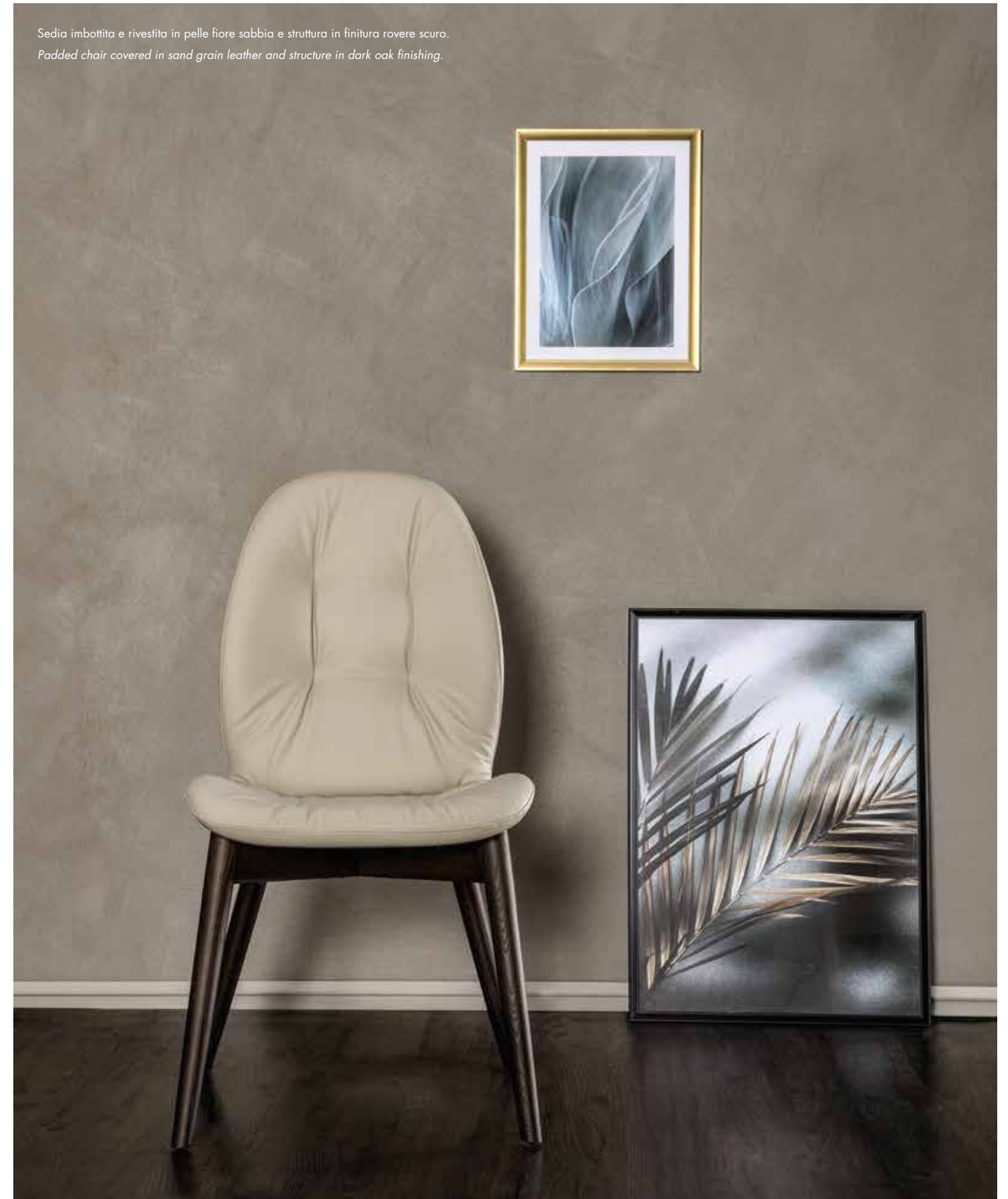

design by\_Angelo Tomaiuolo

Sedia imbottita con struttura in finitura rovere scuro e rivestita nella combinazione Terra bruciata: fronte tessuto Flora grigio scuro - bianco e retro in pelle cognac.  
*Padded chair with dark oak finishing and covered in the "Terra bruciata" combination: dark grey - white Flora fabric front and cognac leather back.*



sorrento esprit

Una nuova scocca dalle dimensioni contenute ma decisamente accattivanti. Scoprila nelle versioni bicolore per dare un tocco in più alla sala da pranzo.

A new body with small but very attractive dimensions. Discover it in bicolour versions to give an extra touch to the dining room.

8044

L 52 P 53 H 49/85 cm

7288

L 62 P 53 H 49/85 cm

Poltroncina imbottita con struttura in finitura noce canaletto e rivestita nella combinazione Terra bruciata: fronte tessuto Flora grigio scuro - bianco e retro in pelle cognac.

Padded armchair with Canaletto walnut finishing and covered in the "Terra bruciata" combination: dark grey - white Flora fabric front and cognac leather back.





# coated

Una credenza con lavorazione spazzolata disponibile nella versione bronzata o rame. Una texture semplice ma di effetto per abbinare le madie alle basi dei nostri tavoli.

A sideboard with brushed finish available in a bronze or copper version. A simple but effective texture to match the sideboards with the bases of our tables.

**8645**

L 110 P 45 H 145 cm

**8643**

L 180 P 45 H 145 cm

**8644**

L 240 P 45 H 75 cm

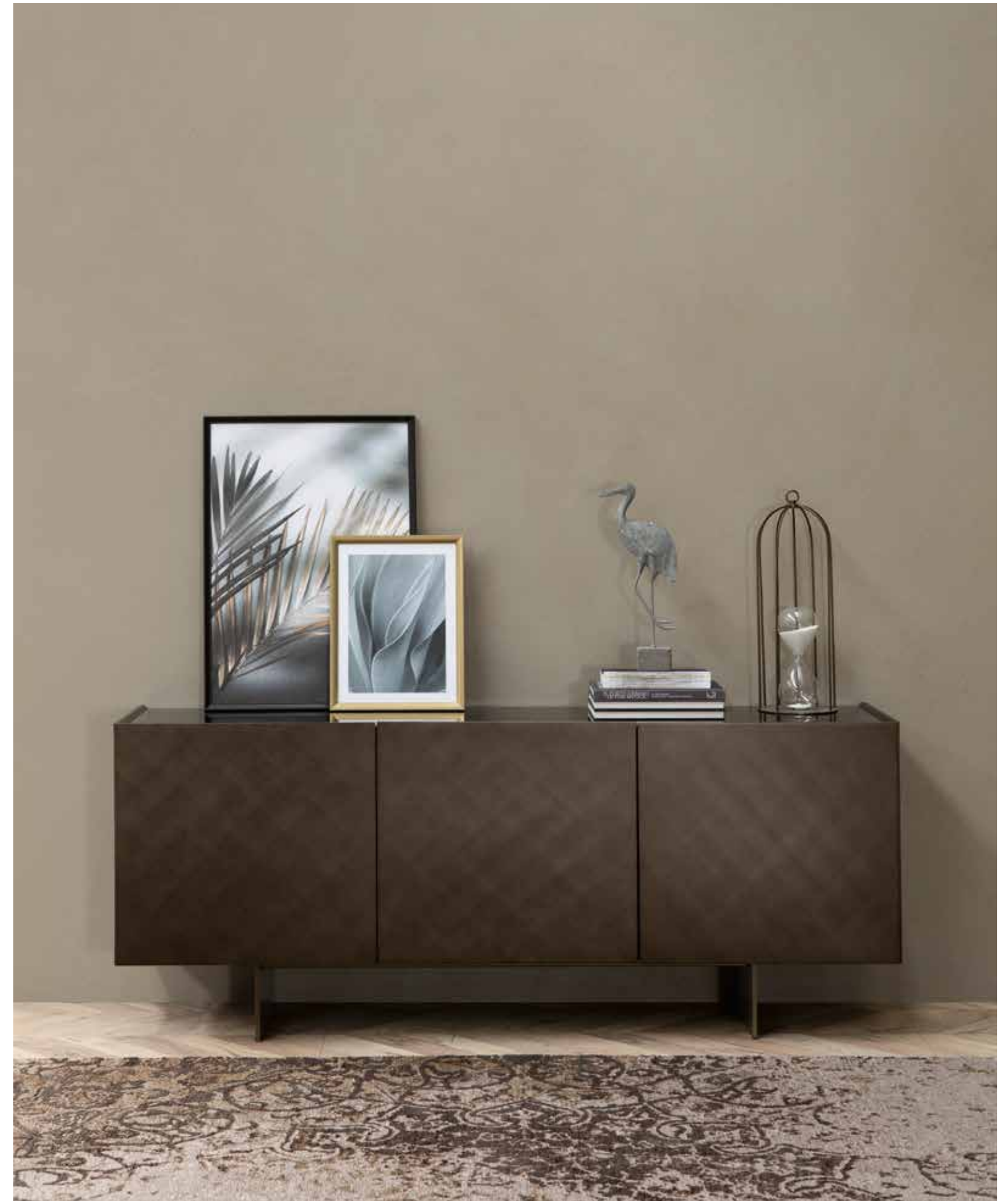



Madia con finitura brushed bronzo e base in metallo bronzato.  
Sideboard with brushed bronze finish and bronzed metal base.



Madia con finitura brushed rame e base in metallo bronzato.  
Sideboard with brushed copper finish and bronzed metal base.



# coral

Credenza con ante a battente in gres porcellanato e struttura in metallo laccato.  
Pensata per essere abbinata ai piani dei tavoli firmati Tonin Casa.

Sideboard with hinged doors in porcelain stoneware and structure in lacquered metal.  
Designed to be combined with the tops of the Tonin Casa tables.



8632

L 220 P 50 H 85 cm

design by\_M. Mottin/E. Barbieri



Madia con ante a battente in gres porcellanato Emperor, struttura in metallo bronzato e top e fianchi in nobilitato laccato testa di moro.

Sideboard with Emperor porcelain stoneware doors, bronzed metal structure and top and sides in dark brown lacquered melamine.



100

101

# drops

Un programma giorno ed un programma notte completo ed estremamente elegante. Gocce in legno massello applicate con estrema cura alle ante effetto specchio. Un top sagomato e stondato fine e sofisticato; una struttura in metallo con inserti in finitura oro. Tutto ciò per non lasciare nulla al caso.

A complete and extremely elegant day program and night group. Solid wood drops applied with extreme care to the mirror effect doors. A fine and sophisticated shaped and rounded top; a metal frame with gold-finish inserts. All this to leave nothing randomly.

8627

L 217 P 47 H 51 cm

8628

L 125 P 56 H 93 cm

8629

L 65 P 47 H 44 cm

8625

L 101 P 47 H 134 cm

8626

L 185 P 47 H 79 cm

8624

L 217 P 47 H 79 cm

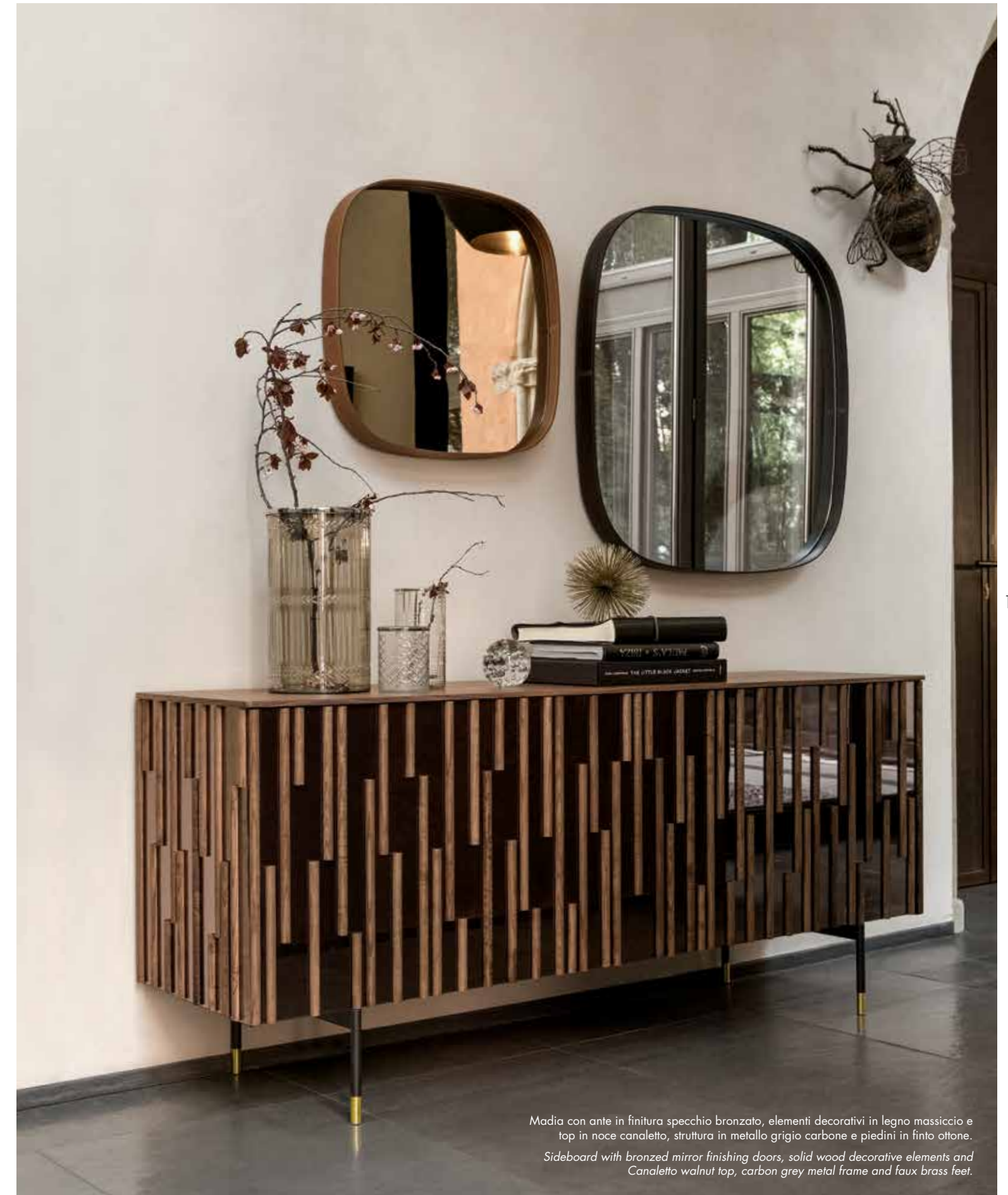

Madia con ante in finitura specchio bronzato, elementi decorativi in legno massiccio e top in noce canaletto, struttura in metallo grigio carbone e piedini in finto ottone.

Sideboard with bronzed mirror finishing doors, solid wood decorative elements and Canaletto walnut top, carbon grey metal frame and faux brass feet.



104

105

Madia con ante in finitura specchio nero, elementi decorativi in legno massiccio e top in frassino nero, struttura in metallo grigio carbone e piedini in finto ottone.  
Sideboard with black mirror doors, solid wood decorative elements and black ash top, carbon grey metal frame and faux brass feet.



Box con ante in finitura specchio bronzato, elementi decorativi in legno massiccio e top in rovere scuro termotrattato, struttura in metallo grigio carbone e piedini in finto ottone.

Storage box with bronzed mirror finishing doors, solid wood decorative elements and heat-treated dark oak top, carbon grey metal frame and faux brass feet.

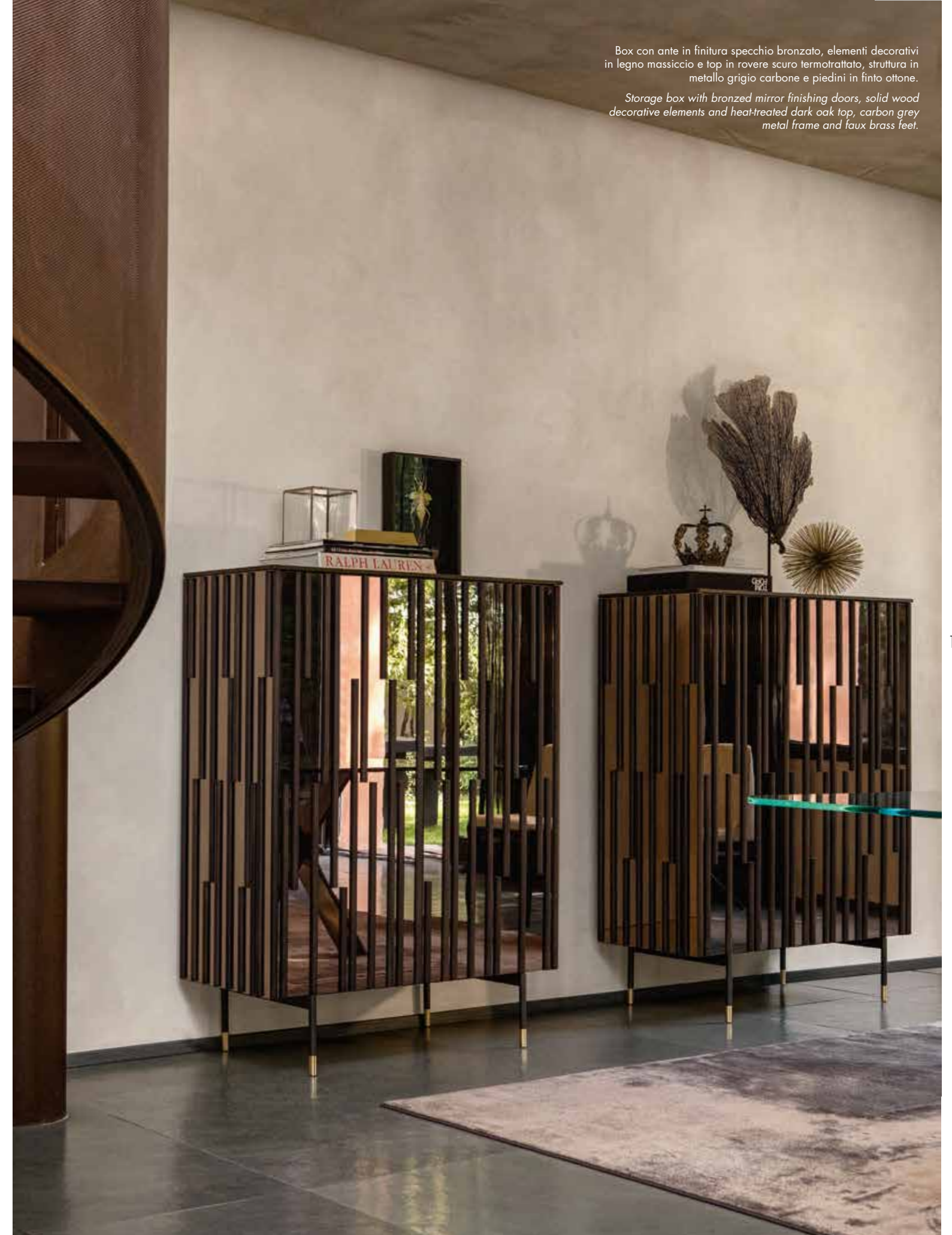

Porta-tv con ante in finitura specchio argento, elementi decorativi in legno massiccio e top in noce canaletto, struttura in metallo grigio carbone e piedini in finto ottone.

TV stand with silver mirror finishing doors, solid wood decorative elements and Canaletto walnut top, carbon grey metal frame and faux brass feet.

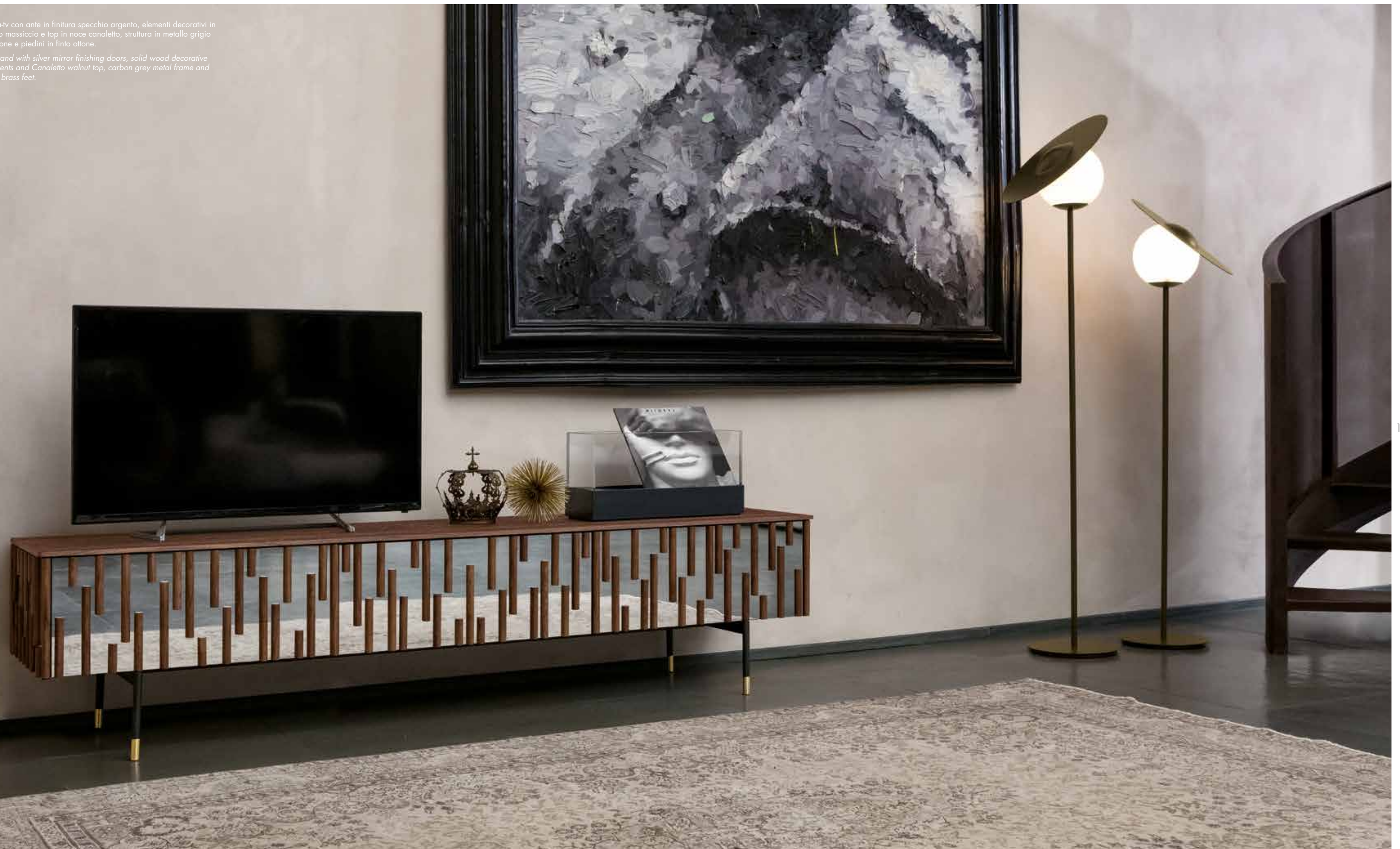

Comodini e comò con ante in finitura specchio bronzato o argentato, elementi decorativi in legno massiccio e top in rovere scuro termotrattato, struttura in metallo grigio carbone e piedini in finto ottone.

*Drawers and dresser with bronzed or silver mirror finishing doors, solid wood decorative elements and heat-treated dark oak top, carbon grey metal frame and faux brass feet.*





Comò con ante in finitura specchio bronzato, elementi decorativi in legno massiccio e top in rovere scuro termotrattato, struttura in metallo grigio carbone e piedini in finto ottone.

*Dresser with bronzed mirror finishing doors, solid wood decorative elements and heat-treated dark oak top, carbon grey metal frame and faux brass feet.*



112



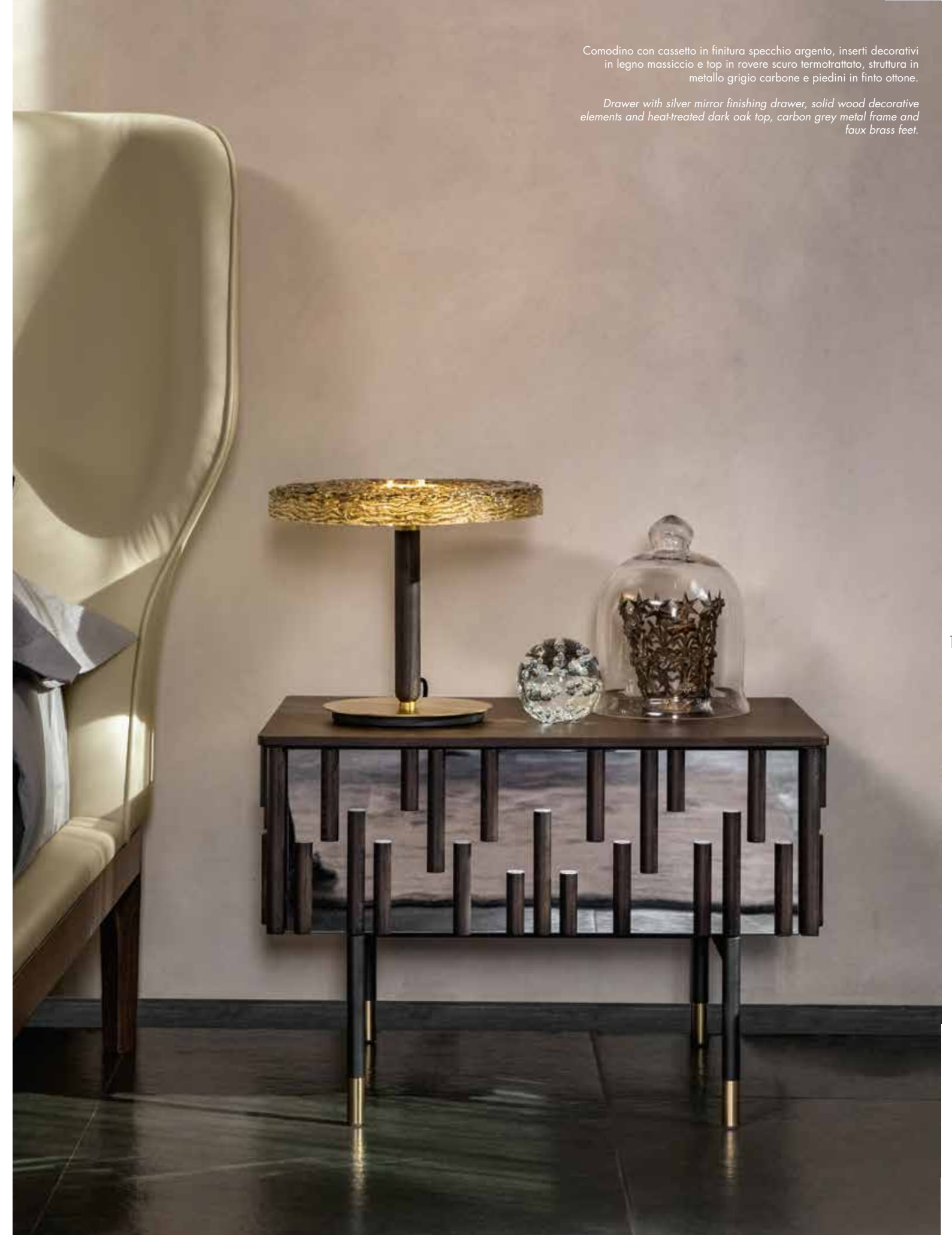

Comodino con cassetto in finitura specchio argento, inserti decorativi in legno massiccio e top in rovere scuro termotrattato, struttura in metallo grigio carbone e piedini in finto ottone.

*Drawer with silver mirror finishing drawer, solid wood decorative elements and heat-treated dark oak top, carbon grey metal frame and faux brass feet.*

# idra

Credenza con ante complanari in gres porcellanato e struttura in metallo laccato.  
Pensata per essere abbinata ai piani dei tavoli firmati Tonin Casa.

Sideboard with complanar doors in porcelain stoneware and structure in lacquered metal.  
Designed to be combined with the tops of the Tonin Casa tables.

8633

L 220 P 50 H 85 cm

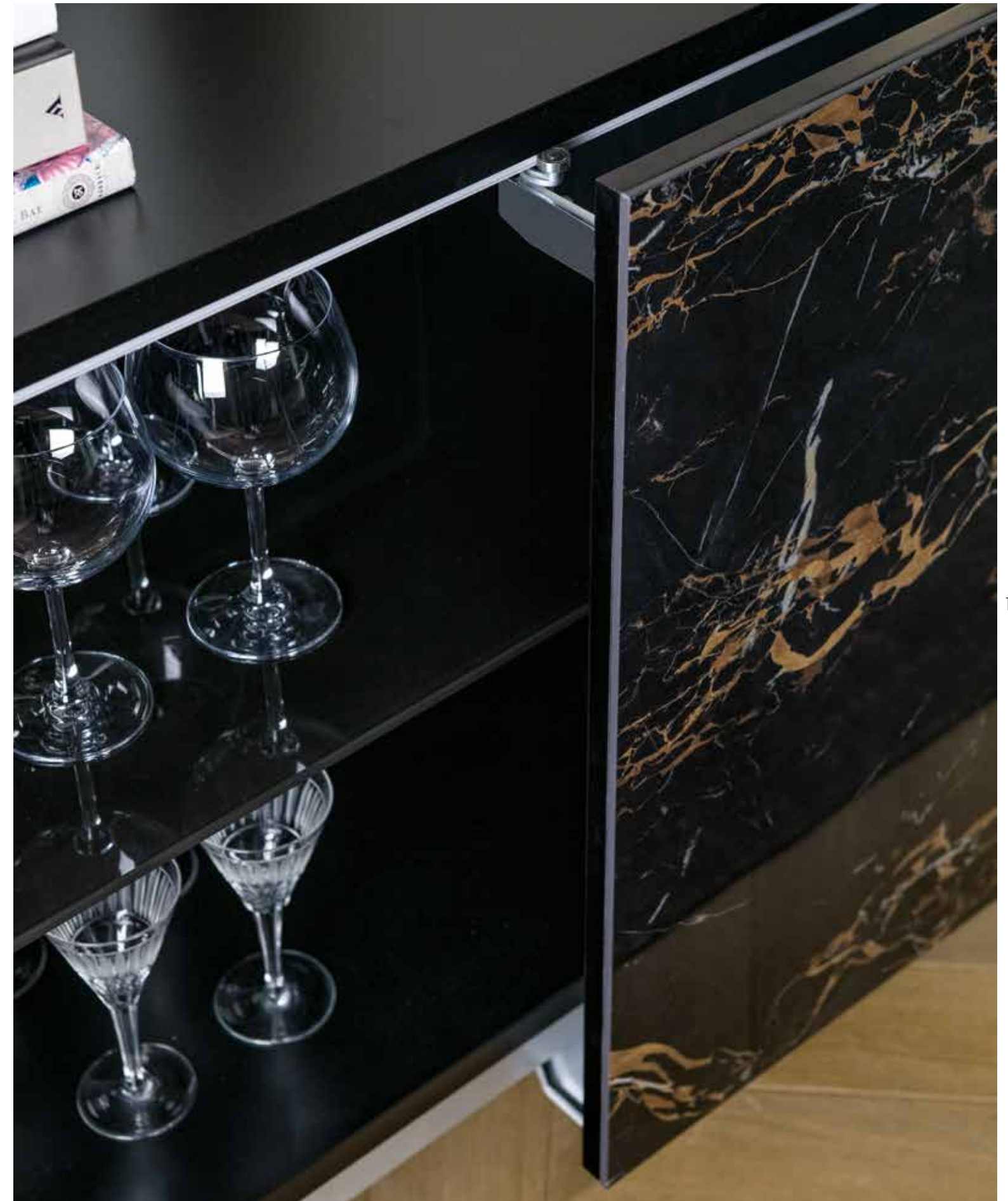

Madia con ante complanari in gres porcellanato Portoro, struttura in metallo grigio carbone e top e fianchi in nobilitato laccato nero.

Sideboard with complanar doors in Portoro porcelain stoneware, carbon grey metal structure and top and sides in black lacquered melamine.





## matisse

Madia in MDF laccato con decoro incassato e dall'effetto traslucente. Un mix di colori giocoso ma elegante che caratterizza Matisse.

Sideboard in lacquered MDF with recessed decoration and translucent effect. A playful but elegant mix of colors that characterizes Matisse.

8634

L 110 P 45 H 145 cm

8638

L 180 P 45 H 75 cm

8639

L 240 P 45 H 75 cm



opera





Madia in noce canaletto con ante e cassetti laccati nero,  
struttura in metallo grigio carbone e piedini in finto ottone.  
*Sideboard in Canaletto walnut with black lacquered doors  
and drawers, carbon gray metal frame and faux brass feet.*

Un design a tutto tondo dove il legno curvo accoglie  
ante e cassetti laccati neri. I dettagli fanno la differenza  
e la rendono unica e adatta al tuo living.

An all-round design where curved wood welcomes  
black lacquered doors and drawers. The details make  
the difference and make it unique and suitable for your  
living.

8646

L 196 P 50 H 76 cm

News 2019



# tiffany

Porta-tv in legno rivestito in diverse finiture con trapuntatura fatta a mano. Un mobile che arricchisce ogni soggiorno di grande artigianalità e maestria tutta italiana.

Wooden TV stand covered in different finishes with handmade quilting. A piece of furniture that enriches every living with great all-italian craftsmanship.



6446

L 176 P 52 H 54 cm

6447

L 215 P 52 H 54 cm

design by\_Angelo Tomaiuolo

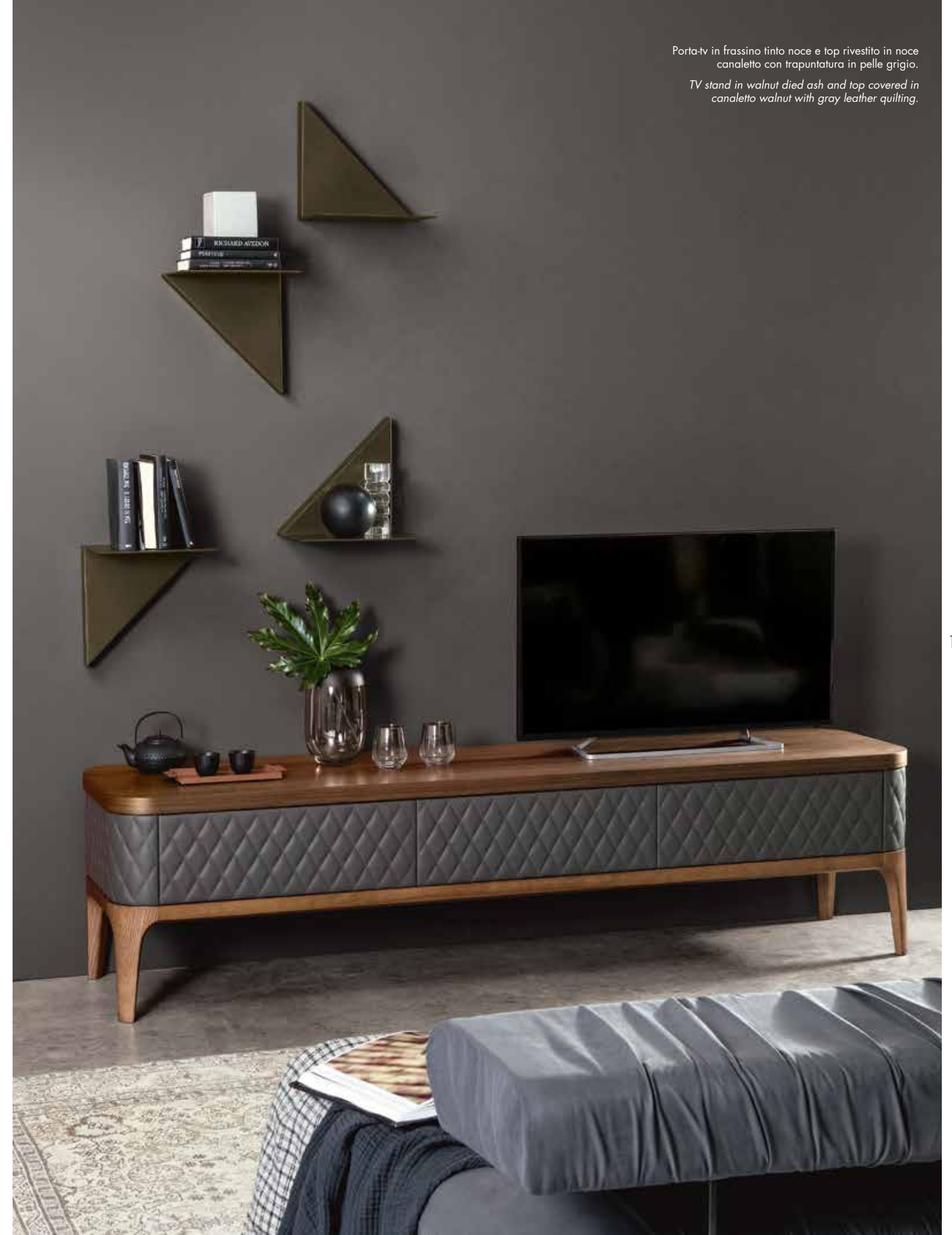

Porta-tv in frassino tinto noce e top rivestito in noce canaletto con trapuntatura in pelle grigio.  
TV stand in walnut died ash and top covered in canaletto walnut with gray leather quilting.

129



# albatros



Libreria con struttura in noce canaletto o rovere scuro e mensole laccate bronzo pietra.  
Bookcase with structure in Canaletto walnut and dark oak and lacquered stone bronze shelves.

Libreria a più ripiani con mensole in metallo laccato e sostegno a parete in legno. Perfetta per avere un ambiente di lavoro funzionale e di design.

Multi-shelf bookcase with lacquered metal shelves and wooden wall support. Perfect for a functional and design work environment.

6472

L 97 P 20 H 115 cm



# chèri

Eleganti teche di cristallo, con schienale specchiante e decorate con particolari in vero cuoio pensate per arricchire con un tocco di stile ogni living.

Elegant crystal glass showcases, with mirrored backs and decorated with thick leather details designed to enrich any living area with a touch of style.



6477

(P) L 35 P 35 H 100 cm  
(A) L 35 P 35 H 135 cm

design by\_Tosca Design



Vetrinette in cristallo trasparente extra-chiaro in due dimensioni con inserti in vero cuoio cognac, particolari in oro satinato e retro con effetto specchio.

Extra-clear transparent glass showcases in two sizes with inserts in cognac thick leather, details in satin gold and mirror effect back.

Vetrinette in cristallo fumè in due dimensioni con inserti in vero cuoio testa di moro o cognac, particolari in oro satinato e retro con effetto specchio.

*Fumè transparent glass showcases in two sizes with inserts in dark brown or cognac thick leather, details in satin gold and mirror effect back.*



Libreria in metallo laccato bronzo pietra.  
Bookcase in bronze stone lacquered metal.



# nota

Una libreria a muro in metallo ispirata ad una nota musicale. Pratica e pensata per dare un giusto movimento ai tuoi libri.

A metal wall bookcase inspired by a musical note. Practical and designed to give your books a proper movement.



6481

L 70 P 22 H 215 cm

design by\_Michele Scarpa

News 2019

# sand

Eleganti archi bronzati e laccati neri si uniscono come lo Ying Yang per creare questa originale libreria autoportante.

Elegant bronzed and black lacquered arches come together like the Ying Yang to create this original free-standing bookcase.



6474

L 58 P 38 H 190 cm

design by\_Andrea Lucatello

Libreria con struttura in metallo bronzo pietra e nero opaco.  
Bookcase with stone bronze and matt black metal structure.



143





# circle

Un intreccio tra legno e metallo per un orologio analogico all'insegna della semplicità e del design. Una lancetta in finitura oro satinato per dare un giusto tocco di classe.

An twist of wood and metal for an analogue clock in the name of simplicity and design. A needle in satin gold finish to give a just touch of class.



7951  
Ø 60 H 45 cm

design by\_Opaca Lab

Orologio in rovere scuro termotrattato e parte metallo in bronzo pietra. Lancetta in finitura oro satinato.  
Clock in dark heat-treated oak and metal part in stone bronze. Satin gold finish needles.



# hammer

Una coppia di tavolini che si intersecano per offrire la massima funzionalità senza rinunciare al design. Metallo brushed bronze e piani in legno nelle nostre finiture a tua scelta.

A pair of intersecting side tables to offer maximum functionality without sacrificing design. Brushed bronze metal and wooden tops in our finishes of your choice.



6237

(P) Ø 40 H 55 cm  
(A) Ø 45 H 60 cm

Tavolini con struttura in brushed bronzo e piani in frassino nero.  
Side tables with brushed bronze structure and black ash tops.

design by\_M. Mottin/E. Barbieri

# lost

Appendiabiti in filo metallico laccato dal design minimal e funzionale. Disponibili nelle versioni laccate oro opaco, grigio carbone e bronzo pietra.

Coathanger in lacquered metal wire with a minimal and functional design. Available in matt gold lacquered, carbon grey and stone bronze versions.

7412

L 40 P 10 H 176 cm

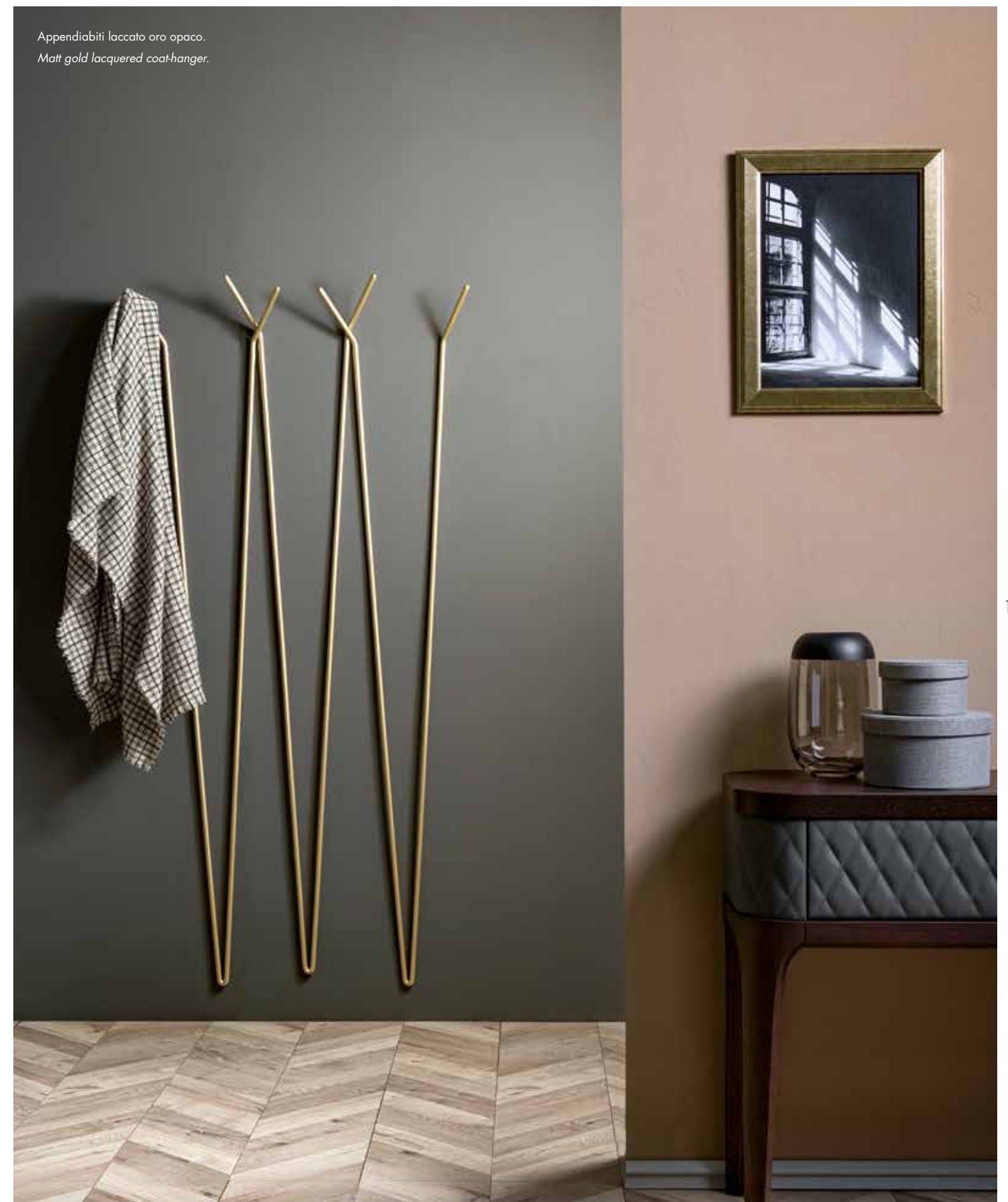

Appendiabiti laccato oro opaco.  
Matt gold lacquered coathanger.

# maistri

Tavolini con base in metallo laccato e piani in vetro martellato o in legno. Linee semplici che esaltano la matericità dei vari piani.

Coffee table and side table with lacquered metal base and hammered glass or wooden tops. Simple lines that enhance the materiality of the various tops.



6216

(P) L 51 P 45 H 38 cm  
(A) L 109 P 45 H 38 cm

design by\_Studio Tonin Creatives

Tavolini con base in metallo laccato grigio carbone e ripiani in vetro martellato nero e vetro martellato oro.  
Side tables with base in carbon grey lacquered metal and tops in black hammered glass and gold hammered glass.



153

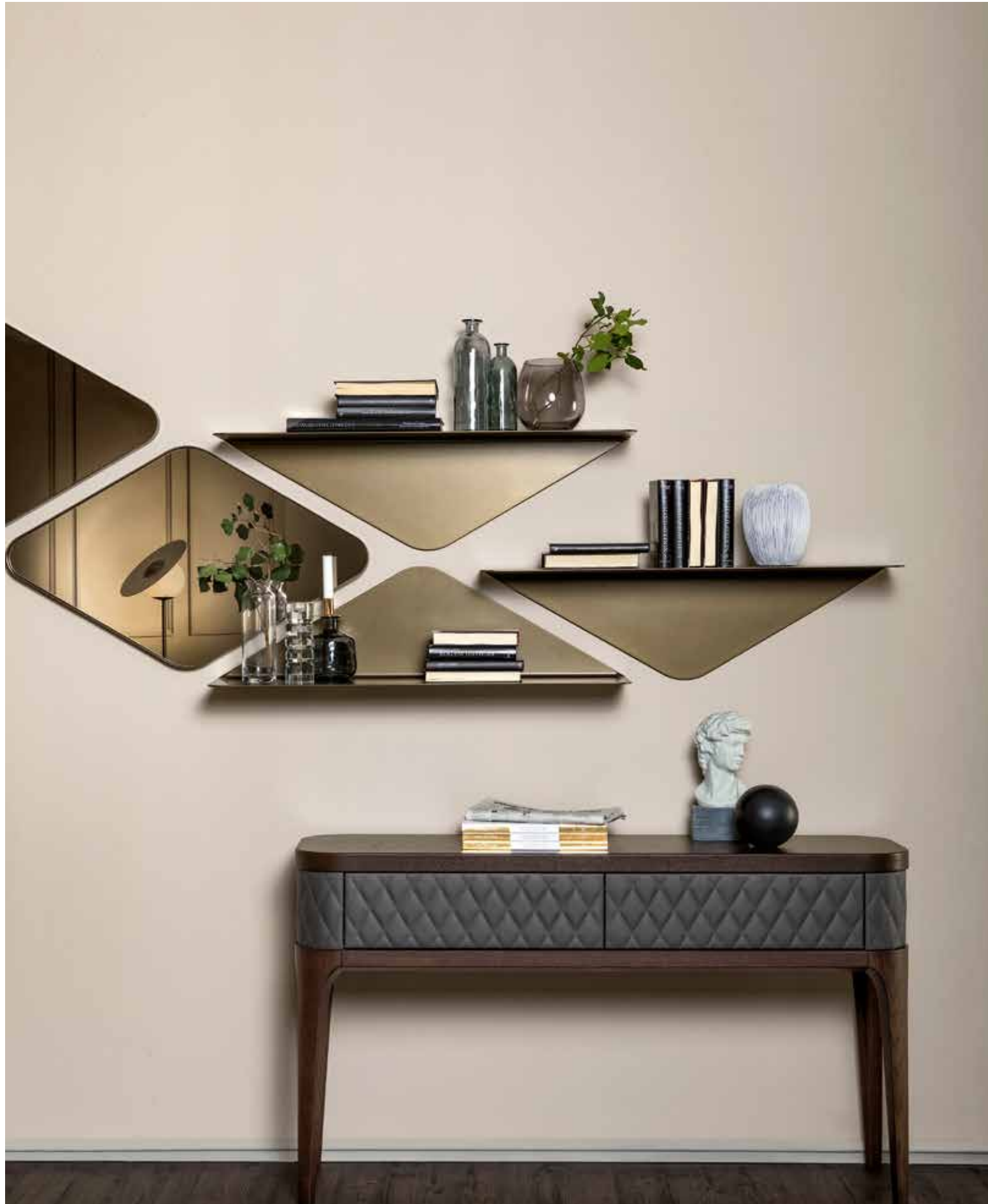

matrix

Per creare le composizioni più dinamiche e di gusto, la famiglia Matrix rappresenta il giusto connubio tra design e funzionalità.

Mensole in metallo laccato e specchiere romboidali bordate in metallo che si abbinano tra di loro creando disegni personalizzabili.

To create the most dynamic and tasteful compositions, the Matrix family represents the right combination of design and functionality.

Shelves in lacquered metal and rhomboid mirrors metal surrounded that match each other creating customizable designs.

6412

L 96 P 25 H 27 cm

7539

L 85 P 3 H 53 cm

Composizione Matrix con mensole in metallo laccato bronzo pietra e specchiere bronzate bordate bronzo pietra.

Matrix composition with bronze stone lacquered metal shelves and bronzed stone surrounded bronzed mirrors.

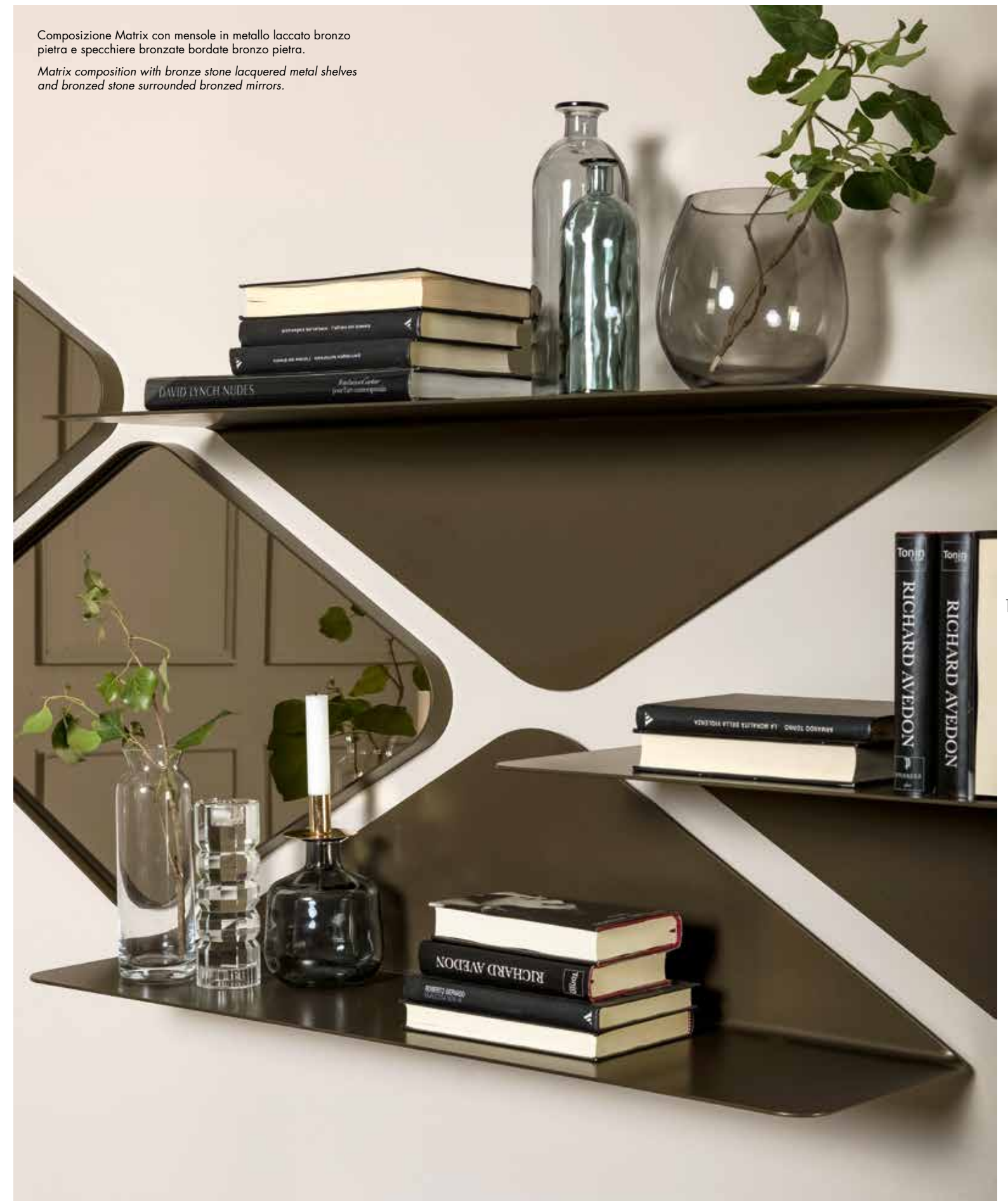

Orologio in metallo laccato nero ed inserti in ceramica oro lucido.  
Black lacquered metal clock and shine gold ceramic inserts.



## memo

Orologio analogico in metallo laccato ed inserti in ceramica. Scandisci il tuo tempo all'insegna della ricercatezza estetica.

Analog clock in lacquered metal and ceramic inserts.  
Scan your time for aesthetic refinement.

7950

Ø 100 P 8 cm

News 2019



# mix

Composizione di tavolini con base in metallo laccato e piani in MDF laccati e stampa digitale o vetro martellato. Svariate altezze e dimensioni per incontrare ogni esigenza.

Composition of coffee table and side tables with lacquered metal base and lacquered MDF tops and digital print or hammered glass.  
Various heights and dimensions to meet every need.



6235

L 78 P 76 H 35 cm

6236

(P) L 38 P 36 H 37 cm

(A) L 38 P 36 H 47 cm

(G) L 38 P 36 H 57 cm

design by\_Studio Tonin Creatives



Servetti con base metallo laccato grigio carbone e piano laccato verde oliva con pattern "ritmo".  
Side tables with carbon grey lacquered metal base and olive green lacquered top with "ritmo" pattern.



Servetti e tavolino con base metallo laccato grigio carbone e piani laccati blu oceano e viola bordeaux con pattern "ritmo".

Side and coffee tables with carbon grey lacquered metal base and ocean blue and burgundy violet lacquered top with "ritmo" pattern.



Servetti con base metallo laccato grigio carbone e piani laccati verde oliva, blu oceano e viola bordeaux con pattern "ritmo".

Side tables with carbon grey lacquered metal base and olive green, ocean blue and burgundy violet lacquered top with "ritmo" pattern.



Servetti con base metallo laccato grigio carbone e piani in vetro martellato oro, nero e rame.  
Side tables with carbon grey lacquered metal base and tops in gold, black and copper hammered glass.



# norman

Una varietà di pattern da mixare per dare un tocco di brio al proprio salotto. Servetto e tavolino con base in metallo laccato e piani in MDF laccato con stampa digitale.

A variety of patterns to mix in order to add a touch of vivacity to your living room. Side table and coffee table with base in lacquered metal and tops in lacquered MDF with digital printing.

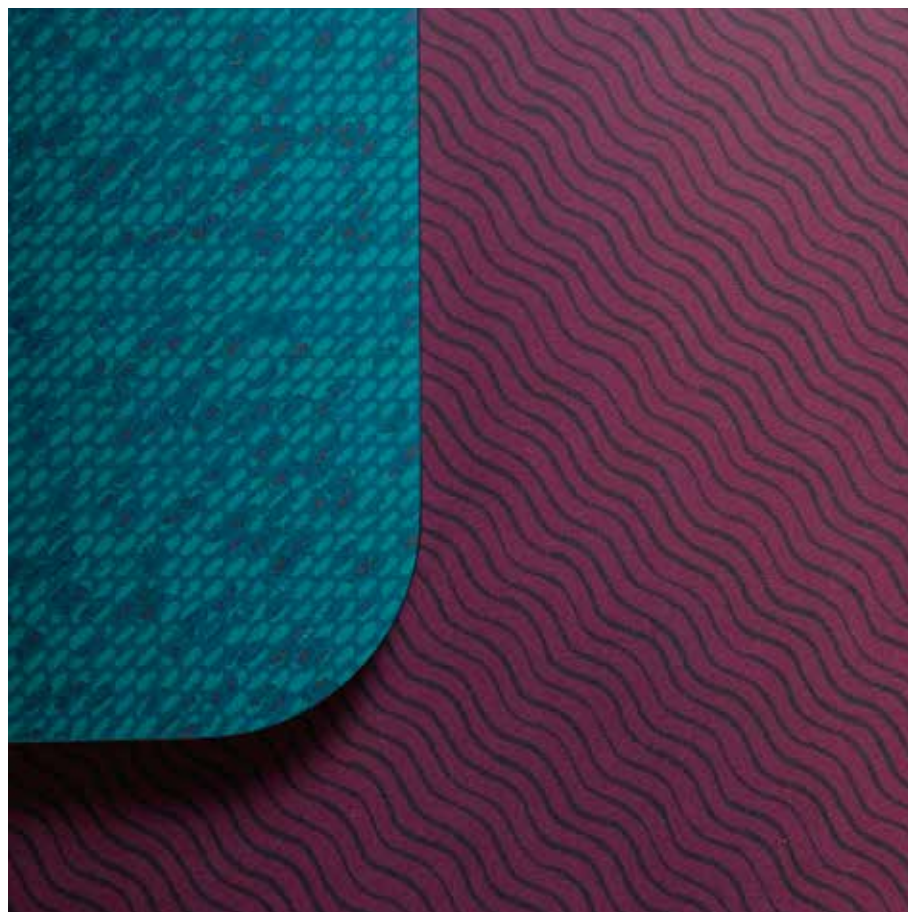

6238

(P) L 48 P 42 H 55 cm  
(A) L 87 P 69 H 36 cm

design by\_Studio Tonin Creatives

Tavolini con base grigio carbone e piani laccati blue oceano con pattern replic e viola bordeaux con pattern "wave".  
Side tables with carbon grey base and ocean blue lacquered top with "replic" pattern and burgundy purple lacquered top with "wave" pattern.



# remind

All'insegna degli anno '60 nasce la collezione Remind, realizzata con una struttura in metallo curvato sapientemente abbinata al vetro bronzato e alle migliori finiture di gres porcellanato, per non lasciare nulla al caso.

Remembering the 60s, the Remind collection is born, made with a curved metal frame skilfully combined with bronzed glass and the best porcelain stoneware finishes.

6241

(P) L 103 P 103 H 35 cm  
(A) L 130 P 80 H 35 cm

6242

L 53 P 53 H 53 cm

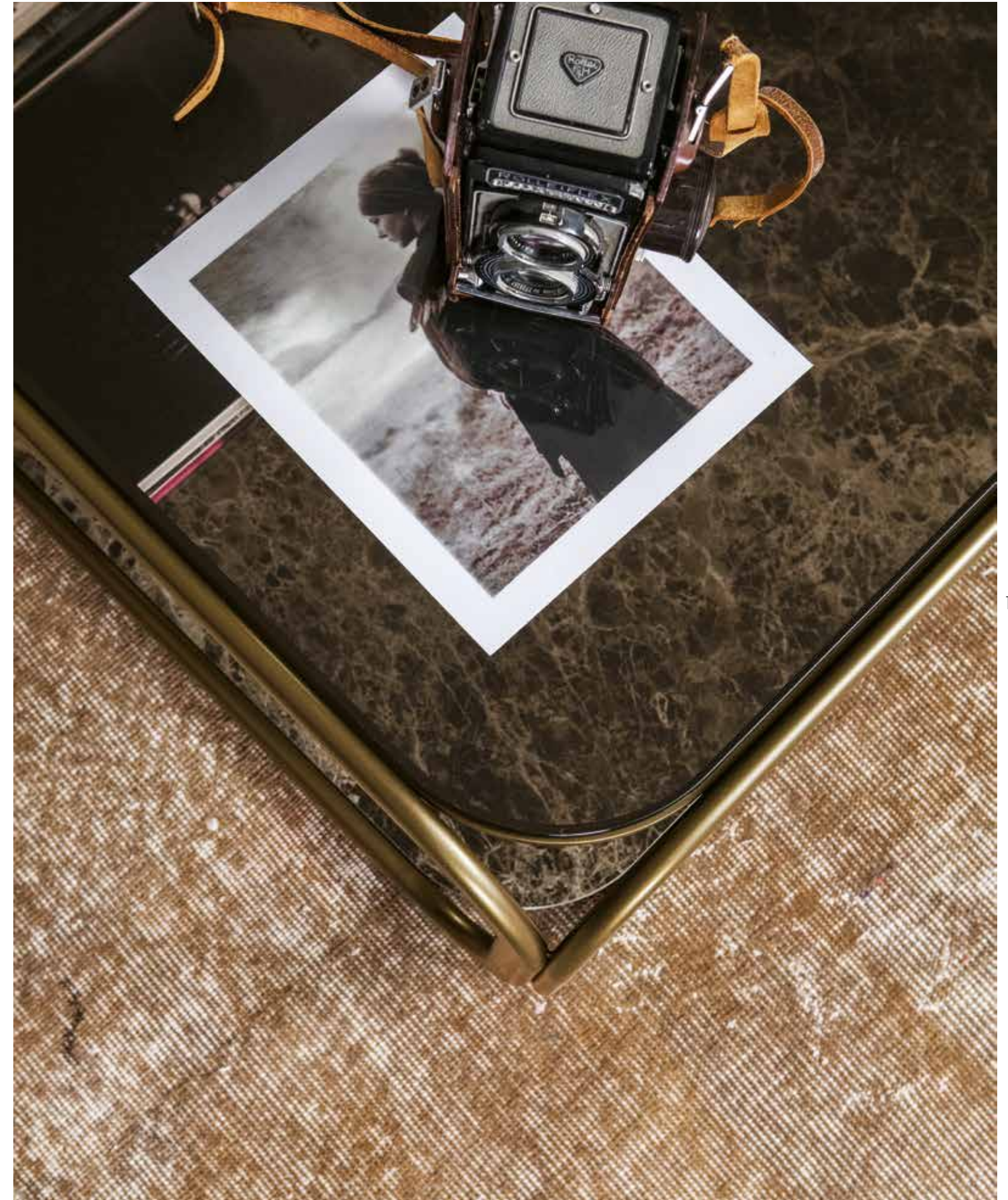

Composizione di tavolini con struttura in metallo laccato bronzo  
pietra, piano in vetro bronzato trasparente e base in gres  
porcellanato Emperador.

Composition of side tables with structure in stone bronze lacquered  
metal, top in transparent bronzed glass and base in Emperador  
porcelain stoneware.



Composizione di tavolini con struttura in metallo laccato bronzo pietra, piano in vetro bronzato trasparente e base in gres porcellanato Onice ambr.

Composition of side tables with structure in stone bronze lacquered metal, top in transparent bronzed glass and base in Onyx amber porcelain stoneware.





# shine

Composizione di tavolini realizzati con i marmi più preziosi che creano ripiani incavati come fossero dei vassoi, e una base laccata in oro opaco.

Composition of side tables and coffee table made with the most precious marbles, that create hollow tops as if they were trays, and with matt gold lacquered base.



6254

Ø 100 H 51 cm

6253

(P) Ø 40 H 88 cm  
(A) Ø 40 H 48 cm  
(G) Ø 60 H 35 cm

design by\_M. Mottin/E. Barbieri



Tavolino con base laccata oro opaco e piano in marmo Emperador.  
Coffee table with matt gold lacquered base and Emperador marble top.

Servetti con base laccata oro opaco e piano in marmo Port Saint Laurent.  
Side tables with matt gold lacquered base and Port Saint Laurent marble top.



178

179



sunset

Un grande classico ridimensionato per allestire il tuo living all'insegna del design. Ripiani in legno noce canaletto, rovere scuro termotrattato e frassino nero, abbinati alle specchiere argentate o bronzate; perchè ogni ambiente deve essere d'ispirazione come un tramonto.

A great classic downsized to set up your living area in the name of design. Shelves in canaletto walnut, heat-treated dark oak and black ash, combined with silver or bronze mirrors; because every environment must be inspired like a sunset.

6411

L 80 P 22 H 50 cm



Mensola con specchio argento e ripiano in noce canaletto.  
Shelf with silver mirror and top in Canaletto walnut.

Appendiabiti in noce massiccio e inserti in oro lucido.  
Coat-hanger in solid walnut with gold inserts.



## tweens

Famiglia di appendiabiti in noce massiccio tornito ed impreziosito con eleganti particolari in finitura oro. Disponibili in due dimensioni e perfetti per dare un tocco di movimento alla parete.

Family of coat-hanger in solid walnut embellished with elegant details in gold finish. Available in two sizes and perfect to give a touch of movement to the wall.



7411

(P) Ø 11 P 6 cm  
(A) Ø 14 P 6 cm

design by\_Opaca Lab

News 2019

design by\_Pravato Design

# vanity

Un appendiabiti ed un portaombrelli dalle forme organiche per rendere originali anche gli oggetti più quotidiani.

A coathanger and an umbrella-holder with organic shapes to make even the most everyday objects original.

7493

Ø 31 H 75 cm

7410

Ø 41 H 168 cm



Appendiabiti in metallo laccato bronzo pietra e portaombrelli laccato rosa agata.  
Coat-hanger in bronze stone lacquered metal and umbrella-holder in pink agate lacquered metal.

Mensole in metallo laccato bronzo pietra.  
Shelves in bronze stone lacquered metal.



design by\_Studio Tonin Creatives

## vela

Per creare le composizioni più svariate, ispirandosi alle vele che galleggiano sul mare, questa mensola si rende adatta. Realizzata in metallo laccato e disponibile in svariate finiture.

This shelf is suitable to create the most varied compositions, inspired by the sails that float on the sea. Made of lacquered metal and available in various finishes.

6413

L 30 P 26 H 30 cm

News 2019





# belty

Specchiere sagomate con dettagli in vero cuoio e particolari in finitura oro. Anche le cose più semplici possono essere le più raffinate.

Shaped mirrors with details in thick leather and details in gold finish. Even the simplest things can be the most refined.

7540

(P) L 64 P 2 H 88 cm  
(A) L 88 P 2 H 112 cm

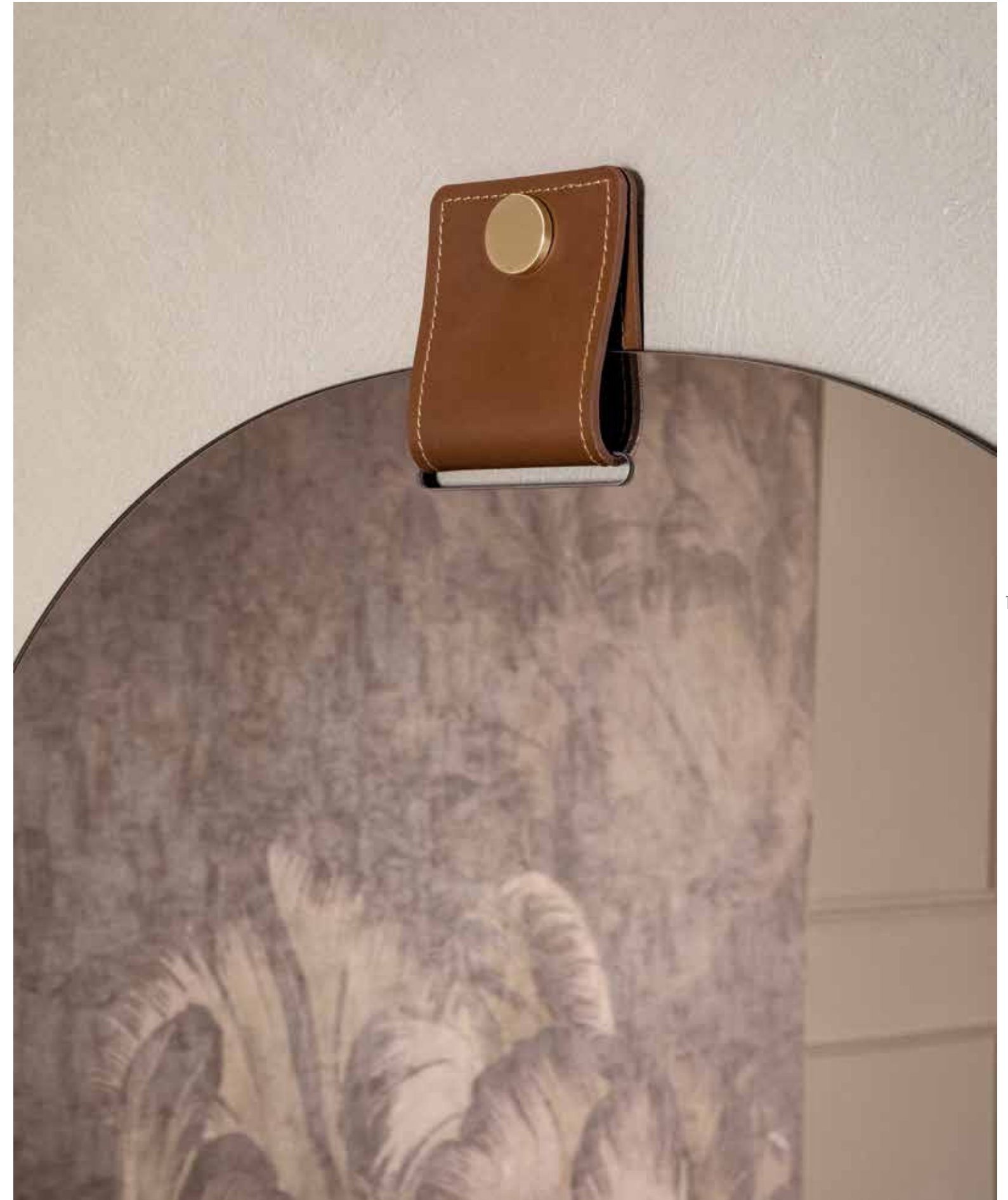

Specchiere bronzate con inserti in cuoio cognac e particolari in oro satinato.  
Bronzed mirrors with inserts in cognac thick leather and details in satin gold.



# macrabè

Una colata di vetro fuso che veste di eleganza uno specchio quadrato o rettangolare pensati per dare un tocco di lusso alla tua casa.

A melted glass casting that dresses a square or rectangular mirror with elegance, to give a touch of luxury to your home.

7538

(P) L 100 P 5 H 100 cm  
(A) L 100 P 5 H 200 cm

Specchiera rettangolare realizzata con colata di vetro fuso fumè su specchio argento.  
*Rectangular mirror made with fumè molten glass casting on a silver mirror.*





Specchiera quadrata realizzata con colata di vetro fuso fumè su specchio argento.  
*Squared mirror made with fumè fused glass casting on a silver mirror.*

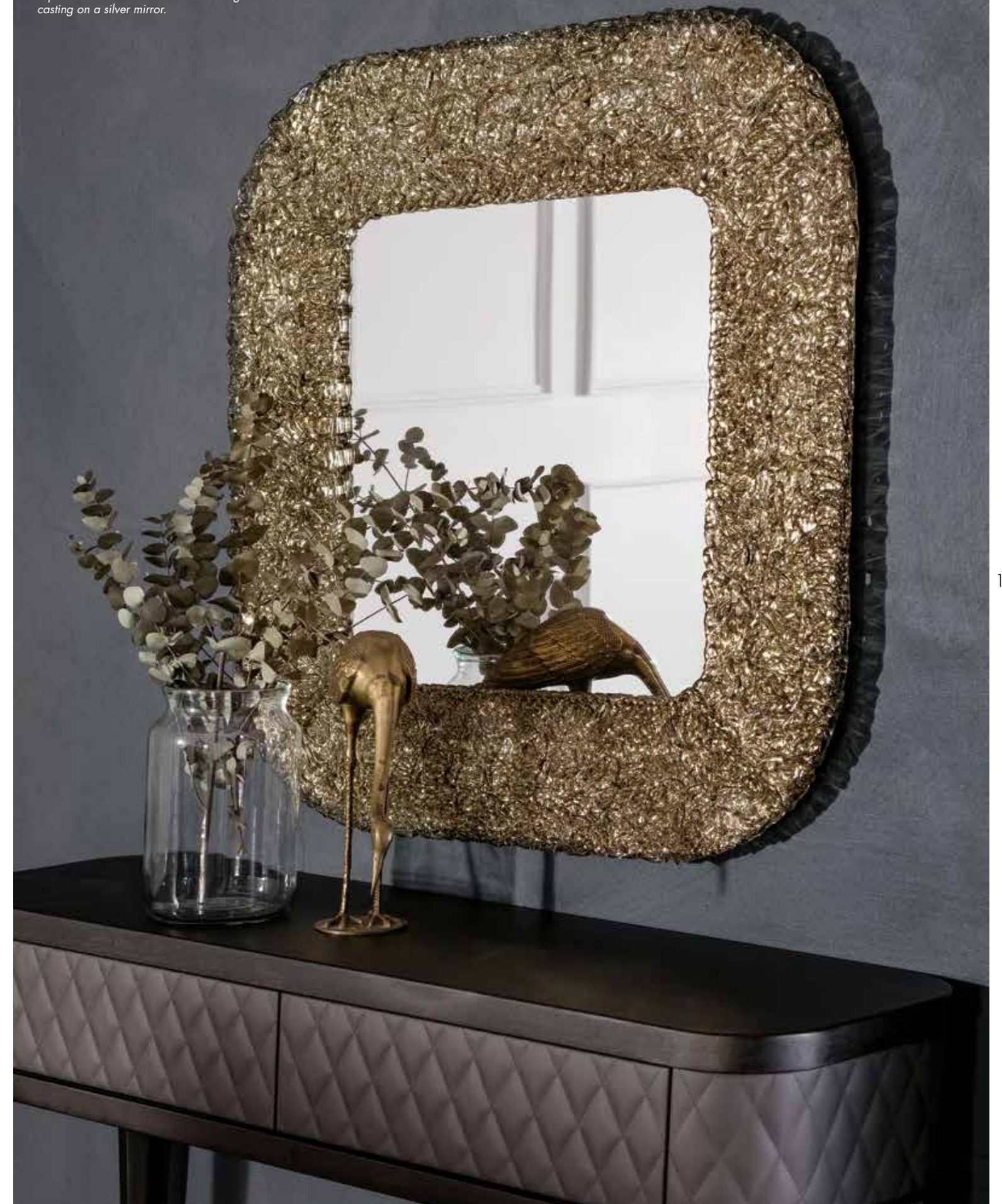

Specchiere in versione specchio fumè sfumate trasparenti.  
Mirrors in fumè mirror version shaded in transparency.



# python

Specchiere sagomate sfumate in trasparenza per dare un tocco di eleganza in più ad ogni vostra riflessione. Intense nella versione bronzo e raffinate nella versione fumè: scegli la combinazione più impattante.

Shaped mirrors shaded in transparency to give a touch of elegance to your every reflection. Intense in the bronze version and refined in the smoked one: choose the most striking combination.



7542

(P) L 40 P 4 H 46 cm  
(A) L 60 P 4 H 69 cm  
(G) L 80 P 4 H 92 cm  
(D) L 120 P 4 H 135 cm

design by\_Opaca Lab

News 2019

# timeless

Specchiera o orologio? Scegli entrambi con Timeless per dare un tocco di classe allo scandire nel tempo. Un abbinamento di specchi di colore diverso per renderlo ancora più unico.

Mirror or clock? Choose both with Timeless to give a touch of class to the scan over time. A combination of mirrors of different colors to make it even more unique.



7543

(P) L 42 P 3 H 120 cm  
(A) L 42 P 3 H 160 cm

design by\_Opaca Lab



Orologio specchio con fondo argento e lavorazione in specchio fumè o specchio oro.  
Mirror clock with silver base and detail in fumè mirror or gold mirror.

Specchiere bronzate o argentate con  
dettaglio in cuoio cognac o testa di moro.  
*Bronze or silver mirrors with cognac or dark  
brown thick leather detail.*



vega

Specchiere sagomate bordate di vero cuoio in finitura  
testa di moro o cognac. Un design minimal e senza tempo.

Shaped mirrors edged in thick leather in dark brown or  
cognac finish. A minimal and timeless design.



7541

(P) L 61 P 6 H 61 cm  
(A) L 91 P 6 H 91 cm

design\_by\_Opaca Lab

News 2019





# dalì

Come gli orologi del grande artista Dalì, il vetro in fusione cola sopra steli di legno rovere massiccio con luce led incassata. Nella versione sospesa il tocco in più è dato dal vero cuoio che la sostiene.

Like the watches by the great artist Dalì, the fused glass drips over solid oak wood stems with a recessed LED light. In the suspended version the extra touch is given by the real leather that supports it.



9116

L 38 P 20 H 33 cm  
L 38 P 5 H 79 cm

design by\_Tosca Design

Lampada da appoggio rovere scuro  
e vetro fuso fumè.  
*Table lamp in dark oak  
and fumè fused glass.*

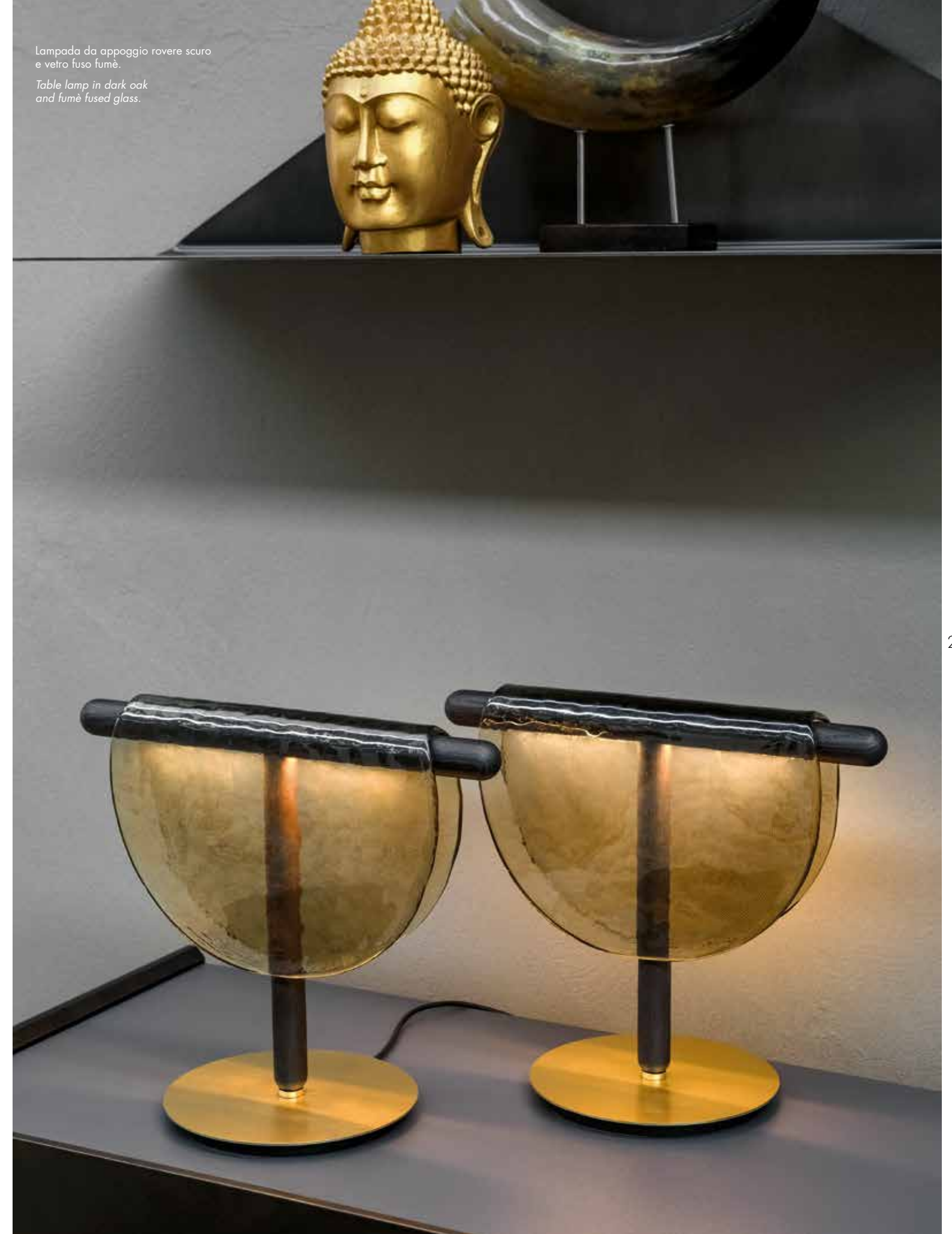

209

Lampade a sospensione in legno noce canaletto o rovere scuro, vetro fuso fumè, ambra e trasparente e inserto in cuoio cognac o testa di moro con particolari in finitura oro satinato.

*Hanging lamps in Canaletto walnut or dark oak, fumè, amber and transparent fused glass and cognac or dark brown leather insert with satin gold finish details.*



Lampada ad appoggio in legno rovere scuro e vetro in fusione fumè con particolari in finitura oro satinato.  
*Table lamp in dark oak and fumè fused glass with details in satin gold finish.*

# macrabè

Uno stampo di vetro colato abbinato al legno rovere massiccio con particolari in finitura oro. Una diffusione di luce omogenea per creare più atmosfera nelle sale da pranzo.

A cast glass mold combined with solid oak wood with details in gold finish. A homogeneous diffusion of light to create more atmosphere in the dining rooms.

9118

Ø 32 H 28 cm  
(P) Ø 22 H 26 cm  
(A) Ø 32 H 26 cm





Lampade a sospensione in legno noce canaletto o rovere scuro e vetro in fusione fumè o trasparente con particolari in finitura oro satinato.  
Hanging lamps in Canaletto walnut or dark oak and fumè or transparent fused glass with details in satin gold finish.

Lampade da terra a doppia altezza in metallo bronzo pietra.  
Double heights free-standing floor lamps in bronze stone metal.



miss

Una boule di vetro satinato che porta un elegante cappellino in metallo come le dame più eleganti di un tempo. Da questa ispirazione nasce Miss disponibile in due altezze.

A satin glass boule that carries an elegant metal hat like the most elegant ladies of the past. From this inspiration, Miss is born and is available in two heights.



9117

(P) L 43 P 36 H 150 cm  
(A) L 43 P 36 H 185 cm

design by\_Opaca Lab

News 2019



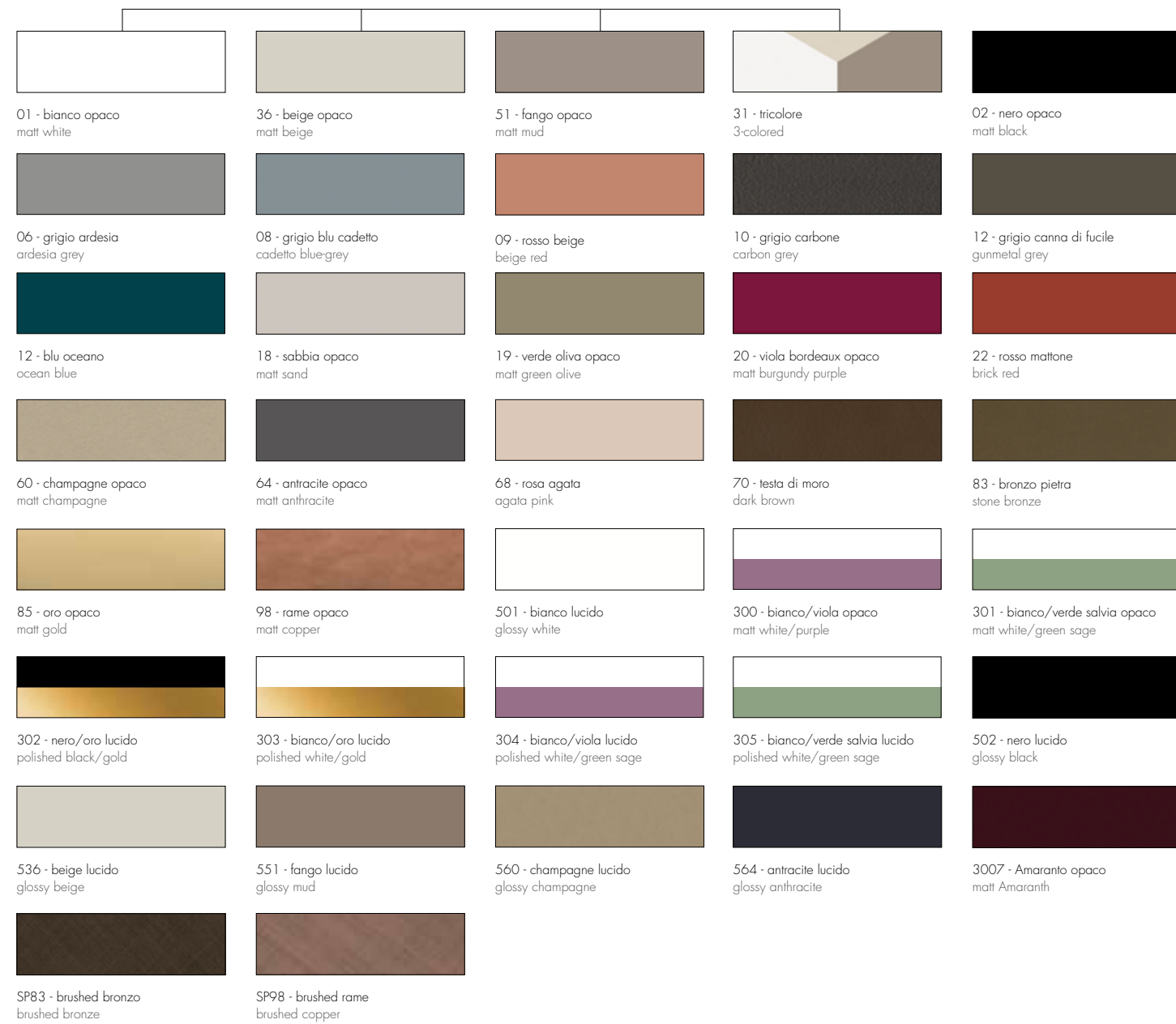

pattern - SD | pattern - SD

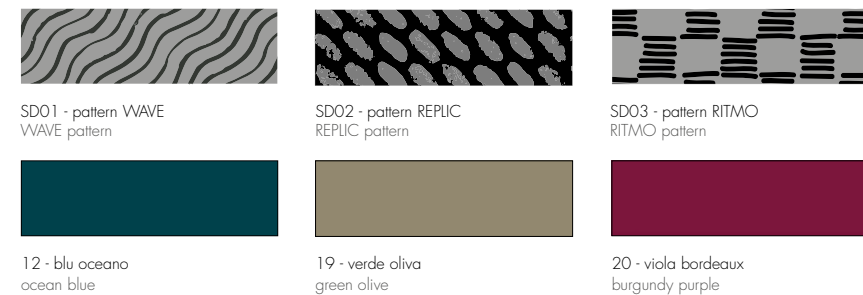

marmi - M | marbles - M

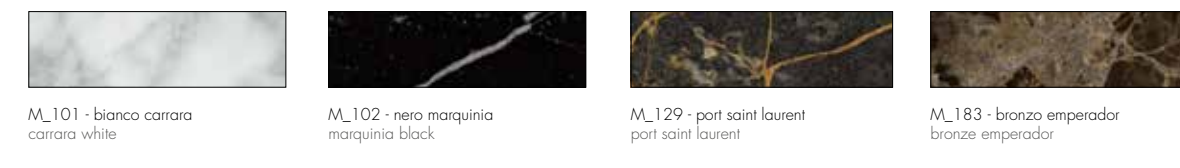

vetro ceramicato - V\_ \_C | ceramic glass - V\_ \_C



gres porcellanato - V\_ \_P | porcelain stoneware - V\_ \_P



laminato - L, LM | laminated - L, LM

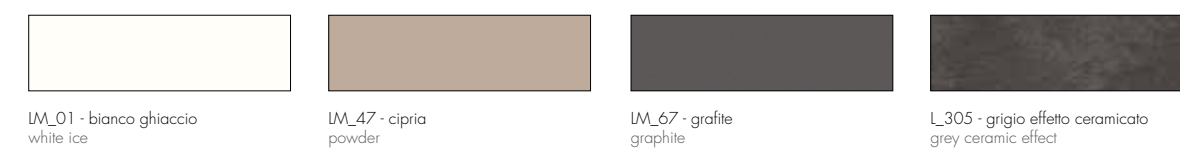

melaminico - PML | melaminic - PML



finiture | finishing

vetri - V, V\_M, VS, VF | glasses - V, V\_M, VS, VF

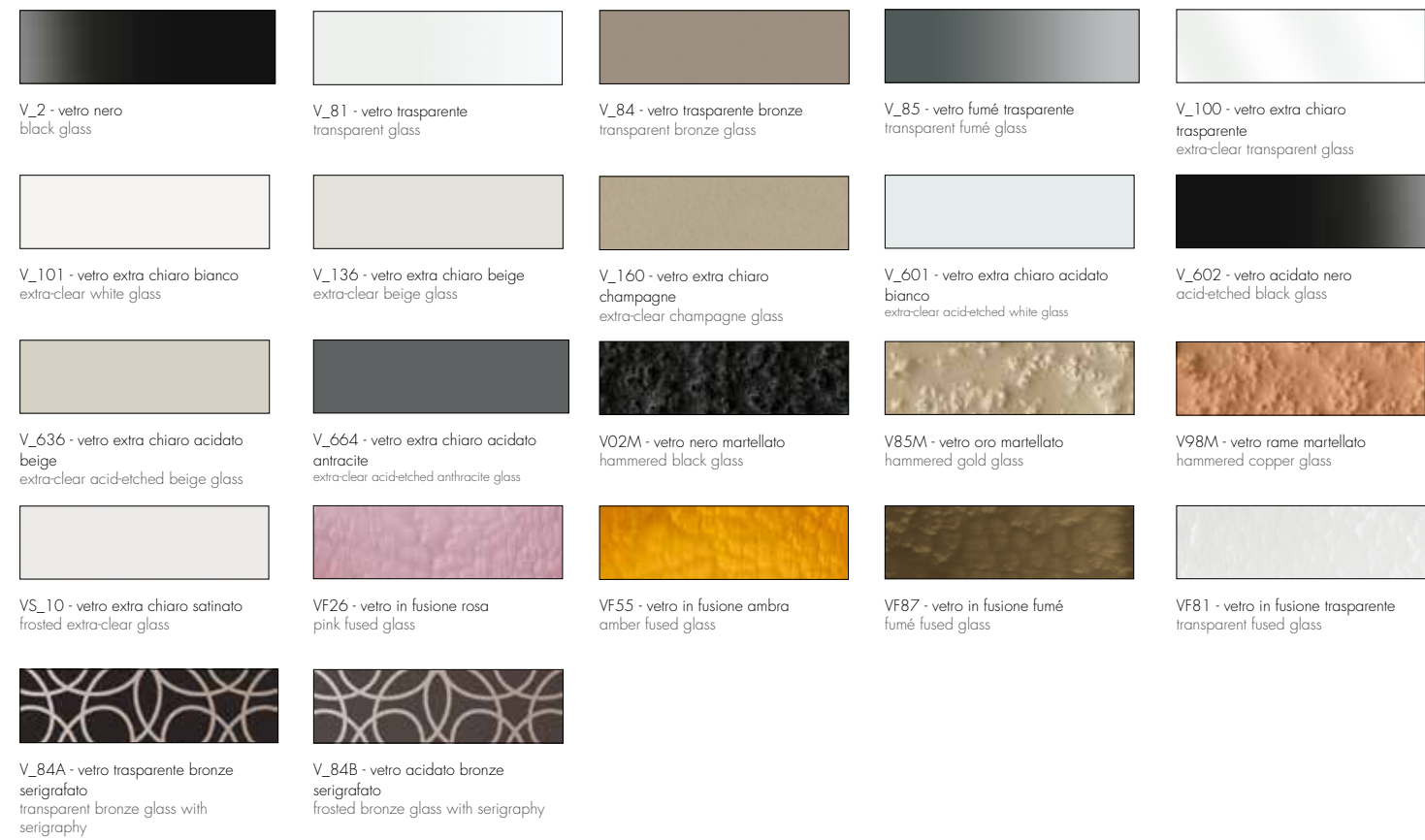

specchi - V, VS | mirrors - V, VS

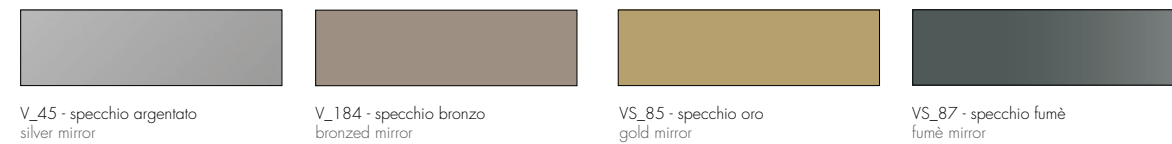

metacrilato (PMMA) - SP | methacrylate (PMMA) - SP

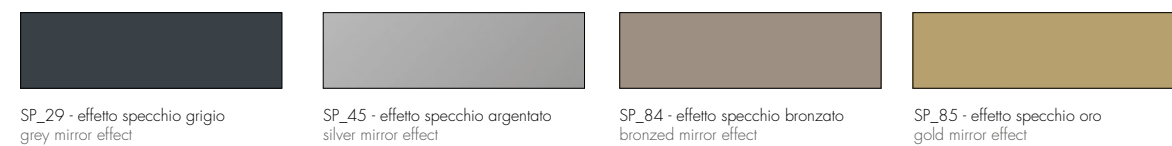

finiture | finishing

polietilene | polyethylene

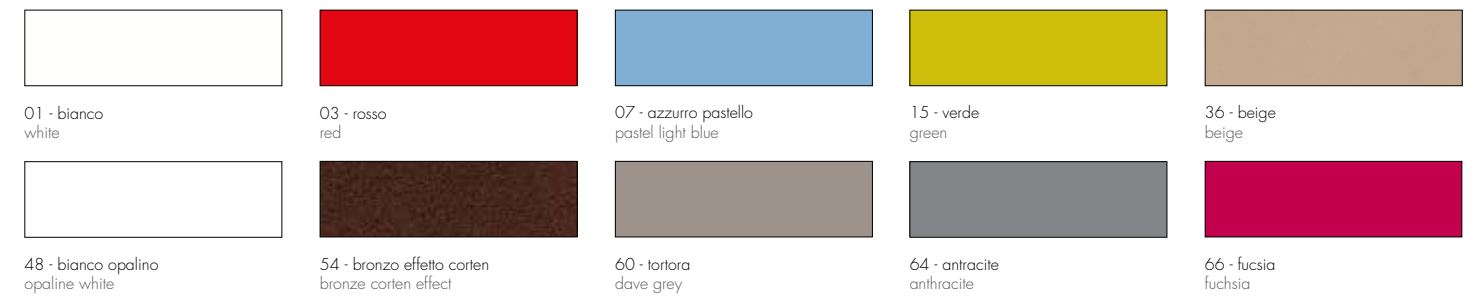

plexiglass - X | plexiglass - X

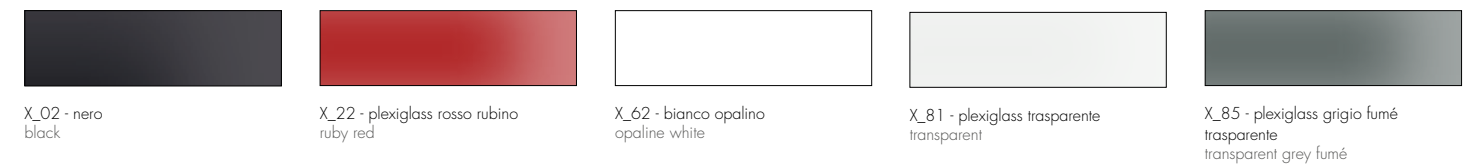

tecnoril | tecnoril



metalli | metals



Cromo | chrome

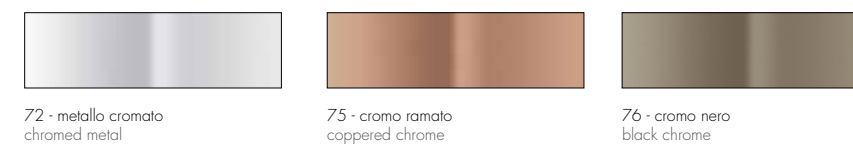



tessuti e pelli | fabrics and leathers

tessuto ninfea - TN | ninfea fabric - TN



tessuto flora - TF | flora fabric - TF



tessuto pied de poule - TP | pied de poule fabric - TP



tessuto gessato - GT | gessato fabric - GT



tessuto sale e pepe - SP | salt and pepper fabric - SP



tessuti e pelli | fabrics and leathers

tessuto verbena - TV | verbena fabric - TV



velluto vega - T\_V | vega velvet - T\_V

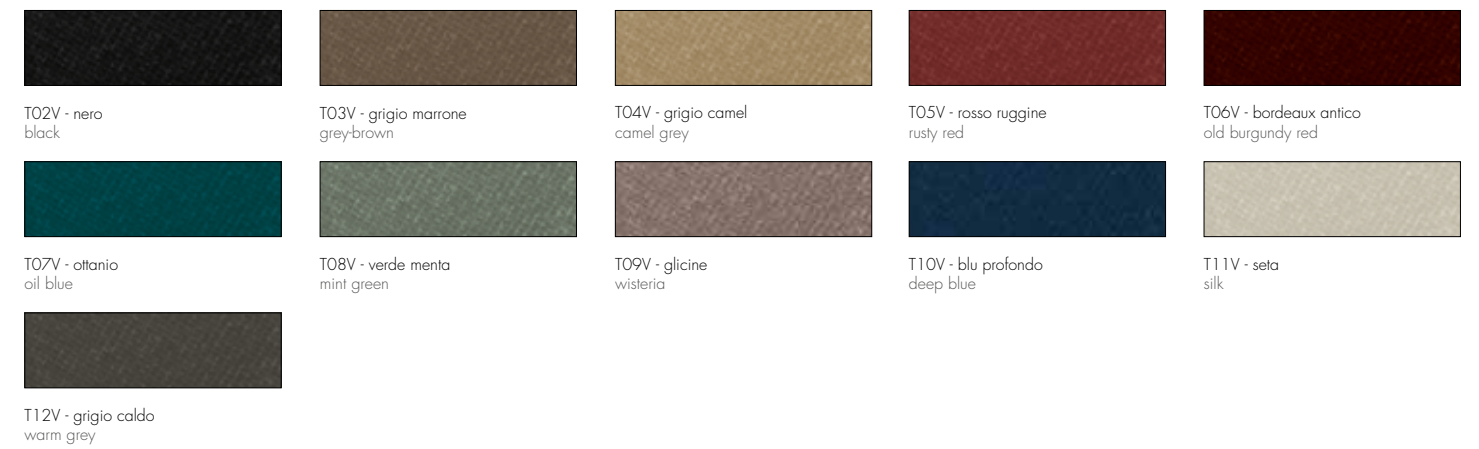

cucitura a contrasto | contrast-stitching

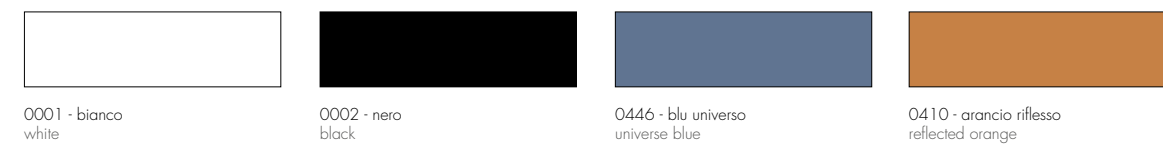

pelle - P | leather - P

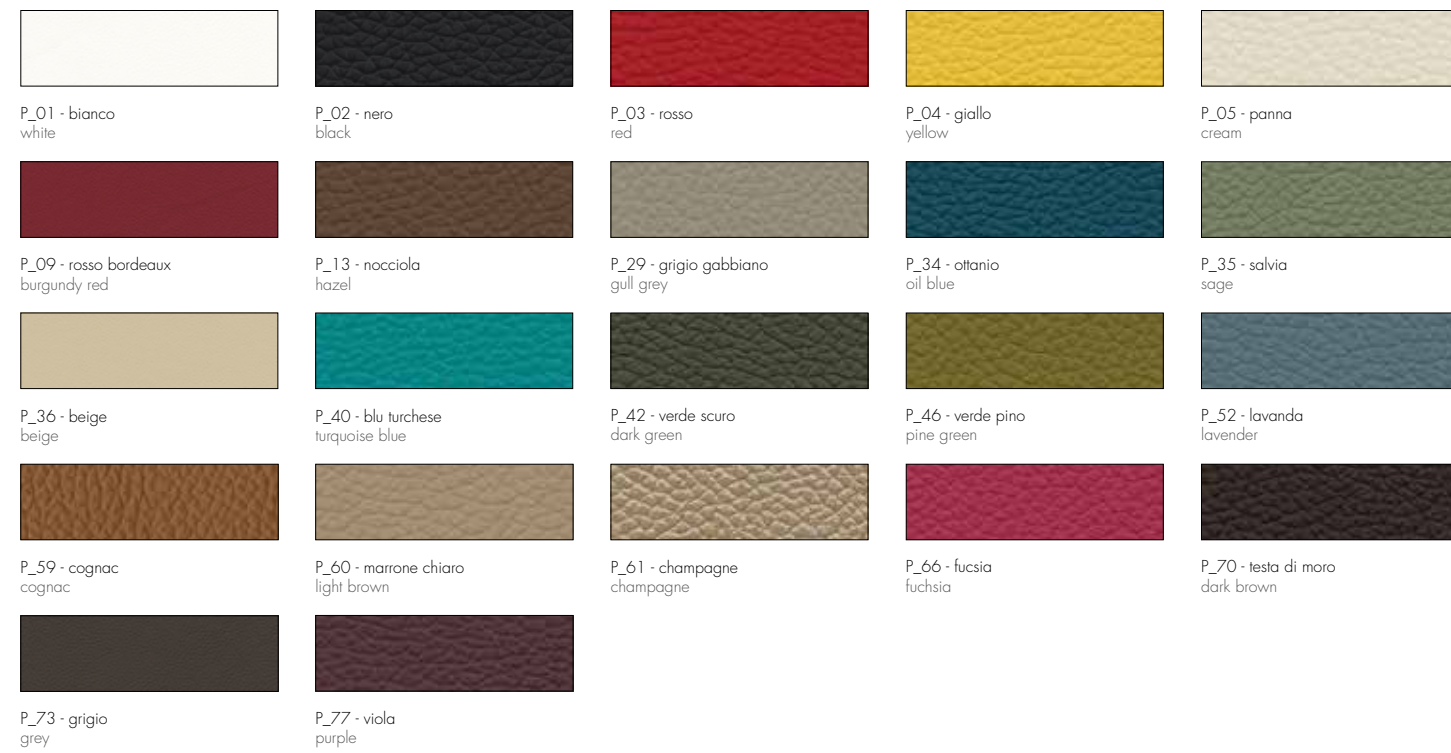

pelle fiore - PF | grain leather - PF



pelle nabuk - PN | nabuk leather - PN



cuoio - K | thick leather - K

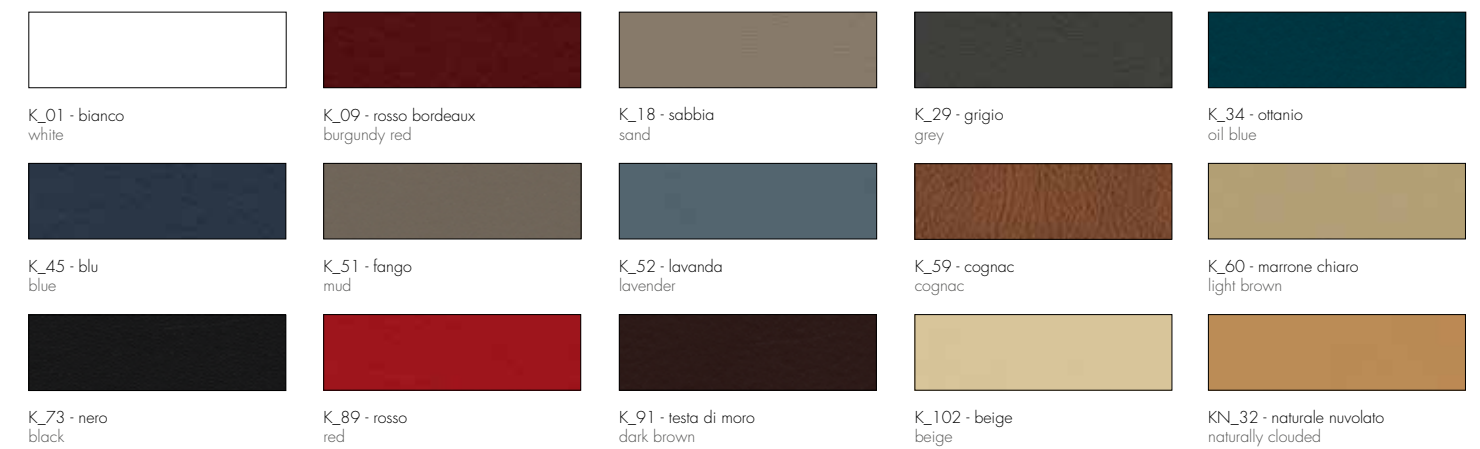

ecopelle - S | eco leather - S

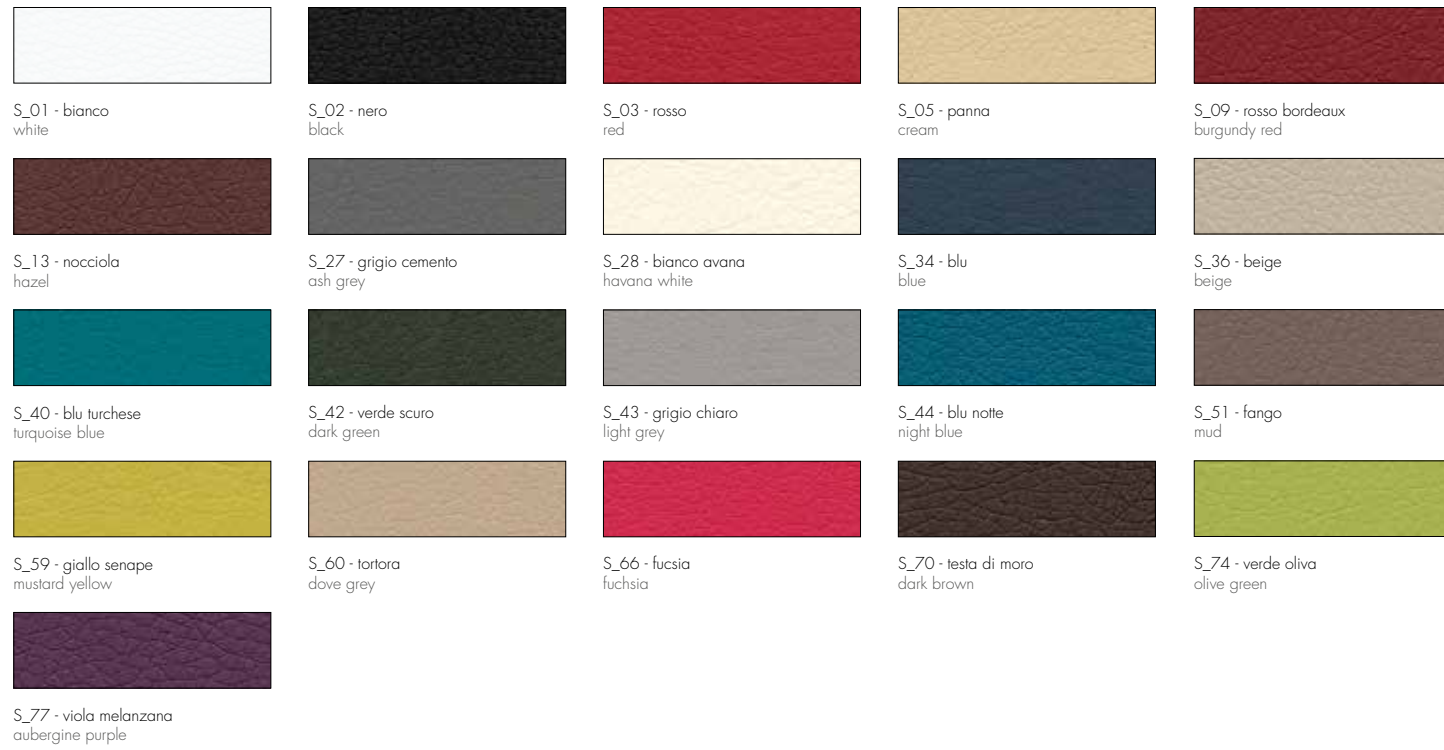

ecopelle nabuk - SN | nabuk eco-leather - SN



specifiche  
specifications

**8070FSV** fixed - glass

(T) Ø 160 H 75 cm  
 (P) L 133 P 133 H 75 cm  
 (A) L 200 P 106 H 75 cm  
 (G) L 250 P 106 H 75 cm  
 (Z) L 300 P 120 H 75 cm



**8070FSV** fixed - glass

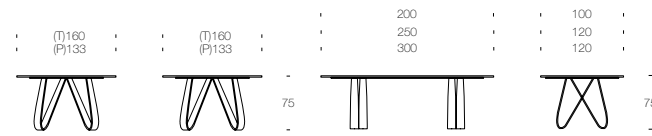

**8070FSL** fixed - wood

(LP) L 133 P 133 H 75 cm  
 (LA) L 200 P 100 H 75 cm  
 (LG) L 250 P 120 H 75 cm  
 (LZ) L 300 P 120 H 75 cm



**8070FSL** fixed - wood

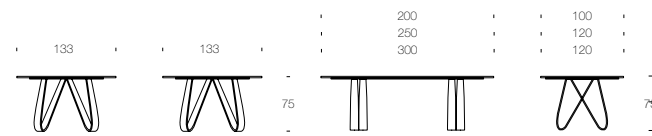

**8070FSM** fixed - marble

(T) Ø 160 H 75 cm  
 (P) L 133 P 133 H 75 cm  
 (A) L 200 P 106 H 75 cm  
 (G) L 250 P 106 H 75 cm



**8070FSM** fixed - marble

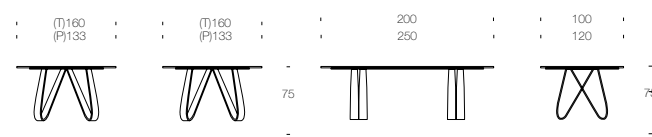

**8070FSC** fixed - ceramic

(P) L 133 P 133 H 75 cm  
 (A) L 200 P 106 H 75 cm  
 (G) L 250 P 106 H 75 cm  
 (Z) L 300 P 120 H 75 cm

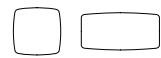

**8070FSL** fixed - wood

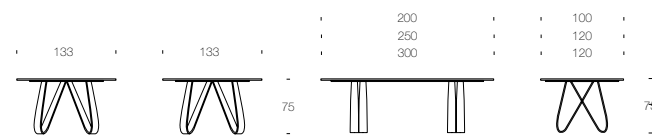

**8070FV** fixed - glass

(FP) L 160 P 90 H 75 cm  
 (FA) L 180 P 90 H 75 cm  
 (FG) L 200 P 100 H 75 cm



**8070FV** fixed - glass

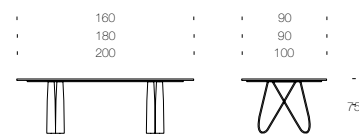

**8070** extendible - glass/ceramic

(P) L 160/240 P 90 H 75 cm  
 (A) L 180/260 P 90 H 75 cm  
 (G) L 200/300 P 100 H 75 cm



**8070** extendible - glass/ceramic

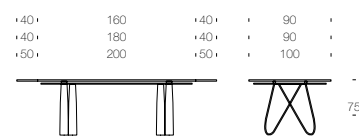

**8099FS** fixed - glass

(A) L 180 P 100 H 75 cm  
 (G) L 215 P 100 H 75 cm  
 (H) L 250 P 120 H 75 cm

**8099FS** fixed - glass/ceramic

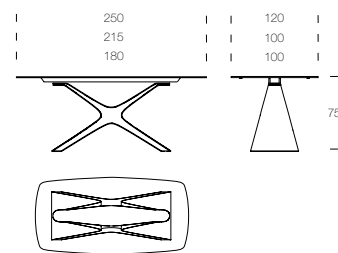

**8099FS** fixed - ceramic

(A) L 180 P 100 H 75 cm  
 (G) L 215 P 100 H 75 cm  
 (H) L 250 P 120 H 75 cm

**8095** fixed - glass/ceramic

(P) Ø 160 H 75 cm  
 (A) Ø 180 H 75 cm  
 (G) Ø 200 H 75 cm

**8095** fixed - glass/ceramic

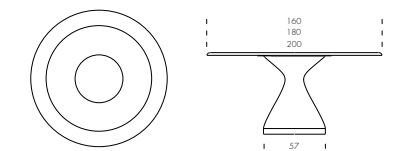

pandora table

**8096FS** fixed - wood

Ø 160 H 75 cm

**8096FS** fixed - wood

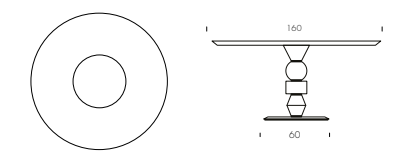

reverse

**8094FS** fixed - glass

(FA) L 180 P 90 H 75 cm  
 (FG) L 200 P 100 H 75 cm  
 (RZ) L 240 P 110 H 75 cm

**8094FS** fixed - glass

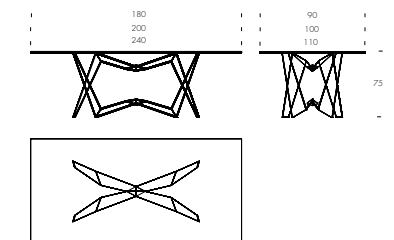

**8093FS** fixed - glass/ceramic

(P) L 150 P 100 H 75 cm  
 (A) L 180 P 100 H 75 cm  
 (G) L 215 P 100 H 75 cm  
 (Z) L 295 P 100 H 75 cm  
 (H) L 300 P 120 H 75 cm

**8093FS** fixed - glass/ceramic

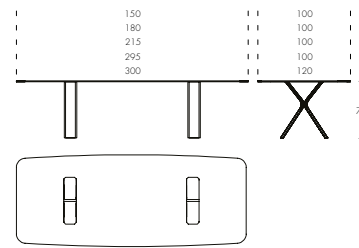

**8093AV** extendible - glass/ceramic

(P) L 150/230 P 100 H 75 cm  
 (A) L 180/260 P 100 H 75 cm  
 (G) L 215/295 P 100 H 75 cm

**8093AV** extendible - glass/ceramic

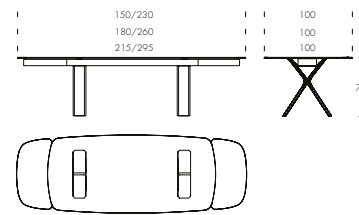

**8103AV** extendible - glass/ceramic

(P) L 160/240 P 90 H 75 cm  
 (A) L 180/260 P 90 H 75 cm  
 (G) L 200/300 P 100 H 75 cm

**8103AV** extendible - glass/ceramic

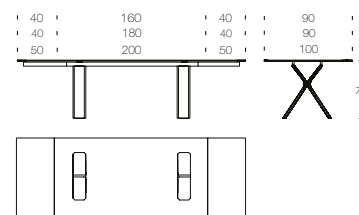

**8097FS** fixed - glass

(T) Ø 140 H 75 cm  
 (P) Ø 160 H 75 cm  
 (A) Ø 180 H 75 cm

**8097FS** fixed - glass

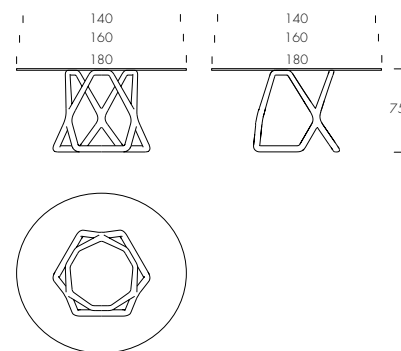

**7290**

L 49 P 54 H 49/80 cm

**7290**

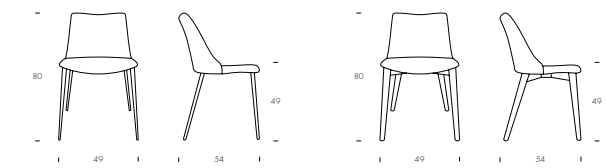

**7291**

L 55 P 59 H 50/79 cm

**7291**

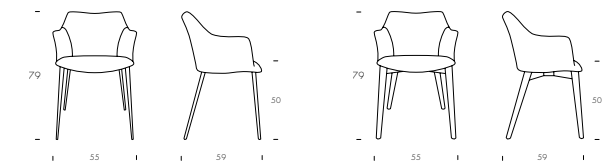

**7292**

L 49 P 50 H 70/93 cm

**7292**

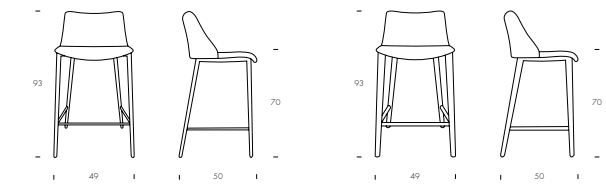

**7345**

L 51 P 54 H 49/80 cm

**7345**

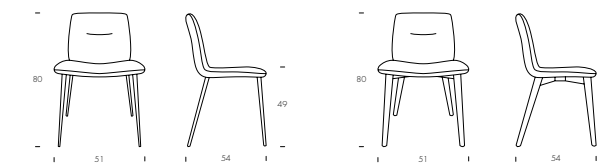

**7346**

L 64 P 59 H 50/79 cm

**7346**

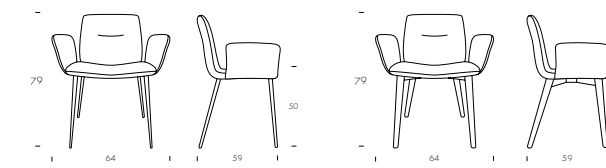

**7347**

L 49 P 50 H 70/93 cm

**7292**

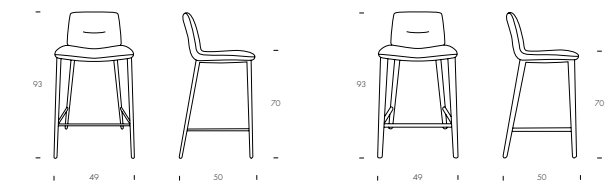

charm élite

7216A

L 44 P 52 H 49/97 cm

7216A

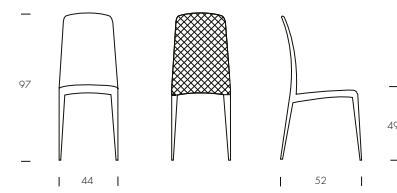

gilda

7254

L 48 P 55 H 46/80 cm

7255

L 65 P 58 H 46/80 cm

7254 - 7255

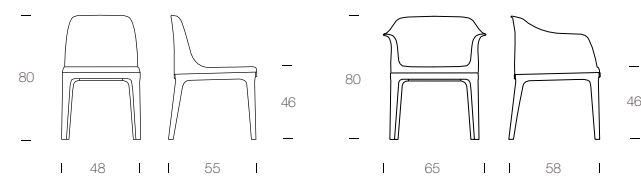

josefine

7287

L 46 P 55 H 47/105 cm

7287

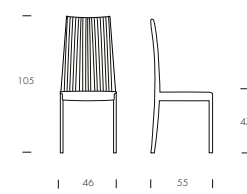

malva élite

7221A

L 47 P 56 H 46/83 cm

7221A

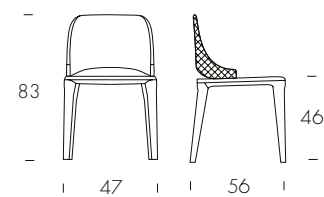

mama

7239

L 61 P 63 H 97 cm

7239

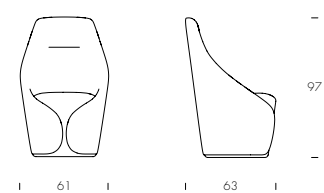

mama

7342

L 81 P 79 H 85 cm

7343

L 81 P 85 H 109 cm

7342 - 7343

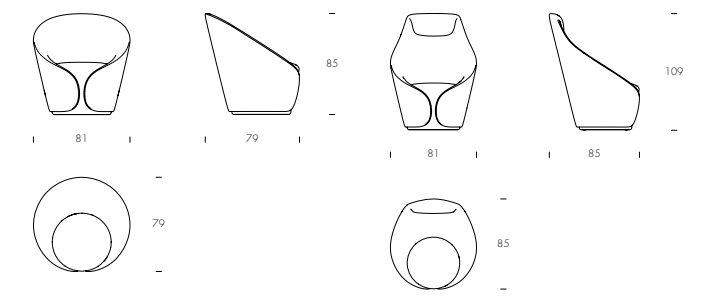

mama

7344

(S) L 175 P 90 H 85 cm  
(B) L 220 P 91 H 85 cm

7344

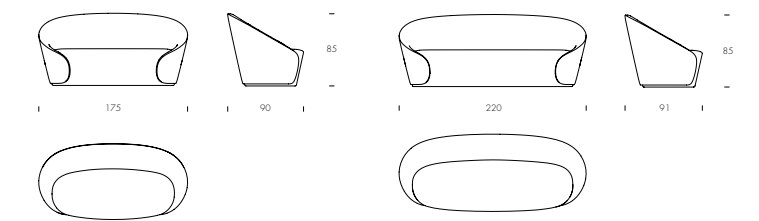

sorrento easy

7284

L 50 P 65 H 47/96 cm

7285

L 63 P 65 H 47/96 cm

7284 - 7285

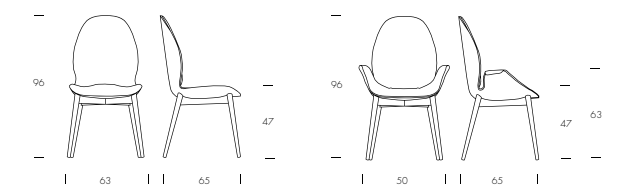

sorrento esprit

8044

L 52 P 53 H 49/85 cm

7288

L 62 P 53 H 49/85 cm

8044 - 7288

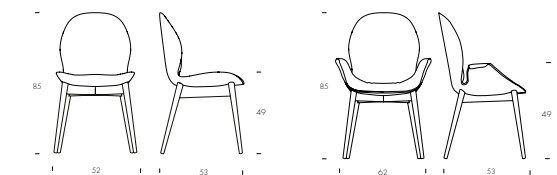

coated

**8645** box

L 110 P 45 H 145 cm

**8643** sideboard

L 180 P 45 H 75 cm

**8644** sideboard

L 240 P 45 H 75 cm

**8645**

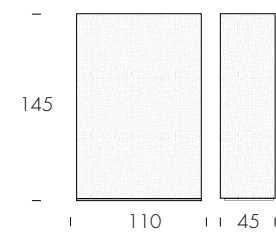

**8643**

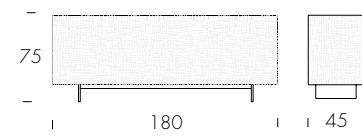

**8644**

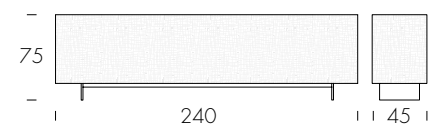

drops

**8625** box

L 101 P 47 H 134 cm

**8626** sideboard

L 185 P 47 H 79 cm

**8624** sideboard

L 217 P 47 H 79 cm

**8627** tv stand

L 217 P 47 H 51 cm

**8628** dresser

L 125 P 56 H 93 cm

**8629** drawer

L 65 P 47 H 44 cm

**8625**

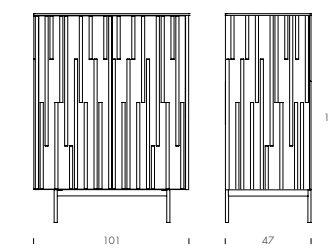

**8626**

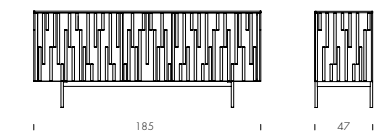

**8624**

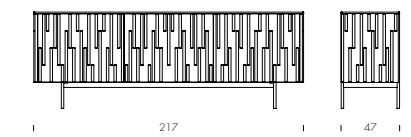

**8627**



**8628**

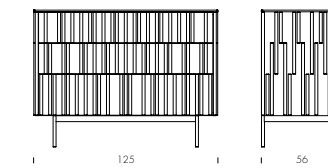

**8629**

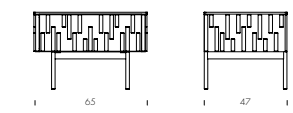

coral

**8632**

L 220 P 50 H 85 cm

**8632**

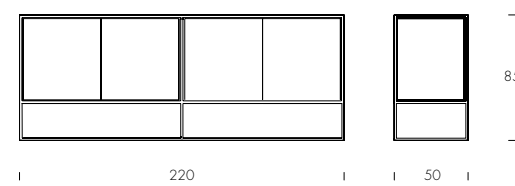

idra

**8633**

L 220 P 50 H 85 cm

**8633**

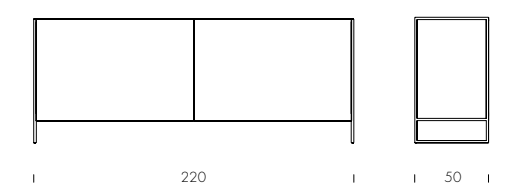



**8634** box

L 110 P 45 H 145 cm

**8638** sideboard

L 180 P 45 H 75 cm

**8639** sideboard

L 240 P 45 H 75 cm

**8634**

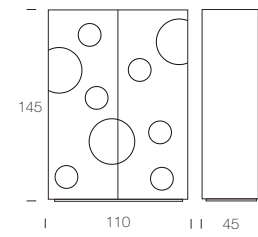

**8638**

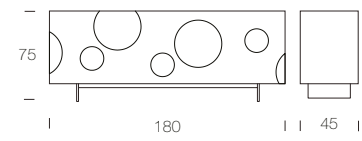

**8639**

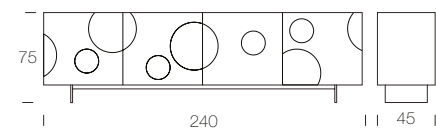

**8646**

L 196 P 50 H 76 cm

**8646**

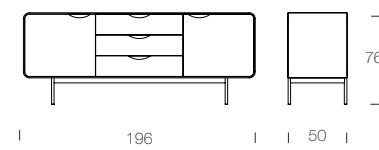

**6446**

L 176 P 52 H 54 cm

**6447**

L 215 P 52 H 54 cm

**6446**

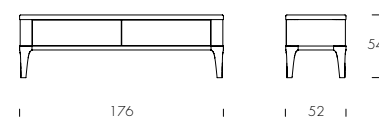

**6447**

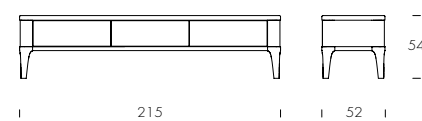

**6472**

L 97 P 20 H 115 cm

**6472**

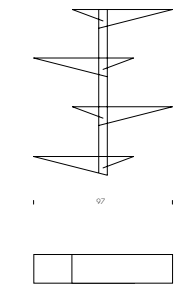

**6477**

(P) L 35 P 35 H 100 cm  
(A) L 35 P 35 H 135 cm

**6477**

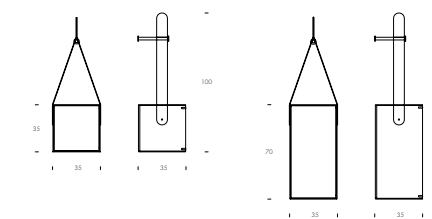

**6481**

L 70 P 22 H 215 cm

**6481**

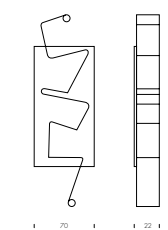

**6474**

L 58 P 38 H 190 cm

**6474**

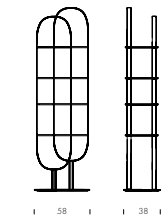

circle

7951

Ø 60 H 45 cm

7951

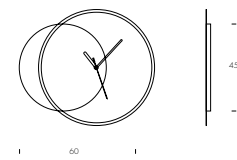

hammer

6237

(P) Ø 40 H 55 cm  
(A) Ø 45 H 60 cm

6237

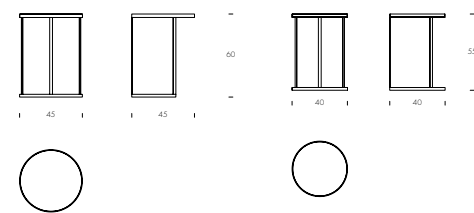

lost

7412

L 40 P 10 H 176 cm

7412

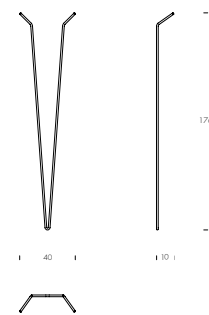

maistri

6216 - glass/wood

L 51 P 45 H 38 cm  
L 109 P 45 H 38 cm

6216 - glass/wood

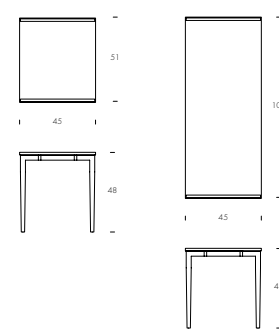

matrix

6412

L 96 P 25 H 27 cm

6412

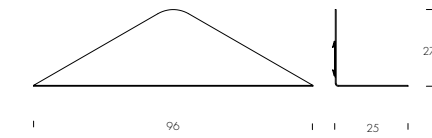

memo

7950

Ø 100 P 8 cm

7950

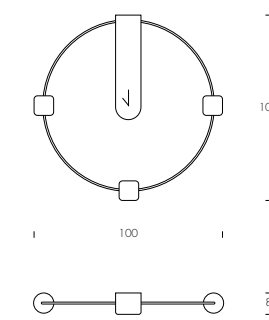

242

mix

6235

L 78 P 76 H 35 cm

6236

(P) L 38 P 36 H 37 cm  
(A) L 38 P 36 H 47 cm  
(G) L 38 P 36 H 57 cm

6235 - 6236

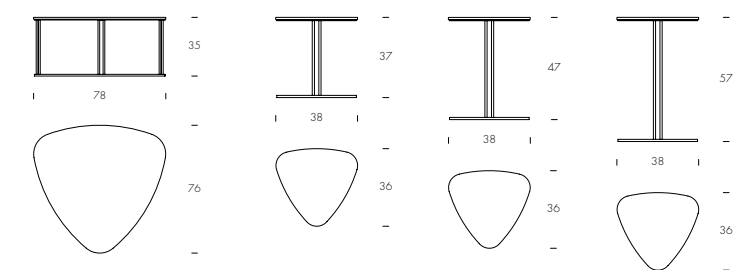

243

norman

6238

(P) L 48 P 42 H 55 cm  
(A) L 87 P 69 H 36 cm

6238

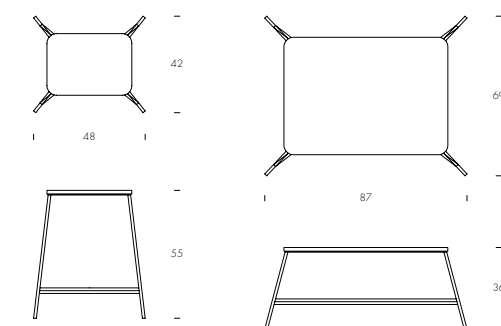

remind

6442

L 53 P 53 H 53 cm

6441

(P) L 103 P 103 H 35 cm  
(A) L 130 P 80 H 35 cm

6442 - 6441

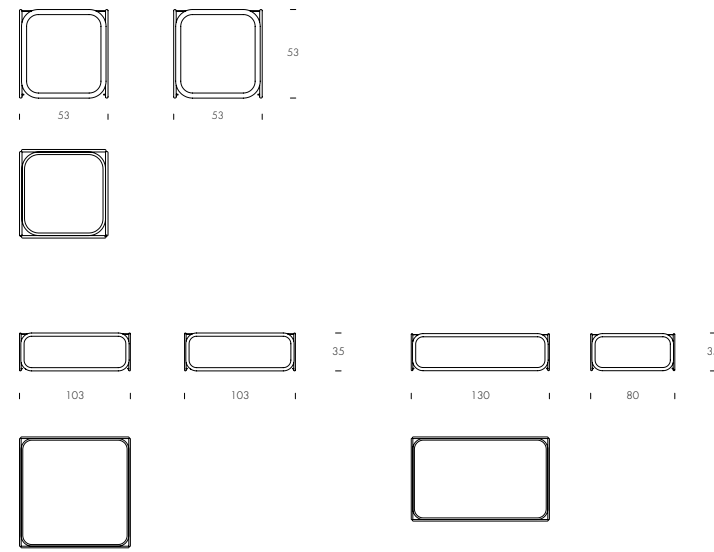

shine

6254

Ø 100 H 51 cm

6253

(P) Ø 40 H 38 cm  
(A) Ø 40 H 48 cm  
(G) Ø 60 H 36 cm

6254 - 6253

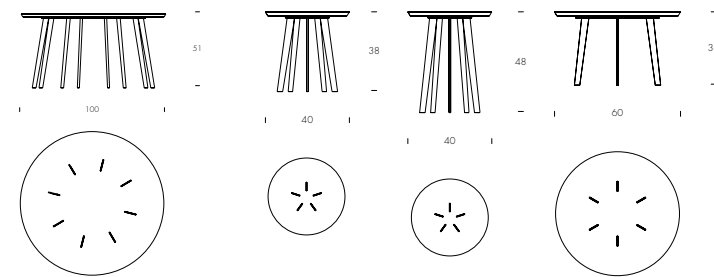

sunset

6411

L 80 P 22 H 50 cm

6411

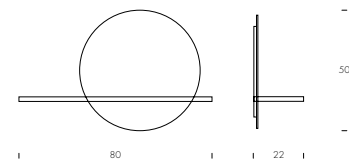

tweens

7411

(P) Ø 11 P 6 cm  
(A) Ø 14 P 6 cm

7411

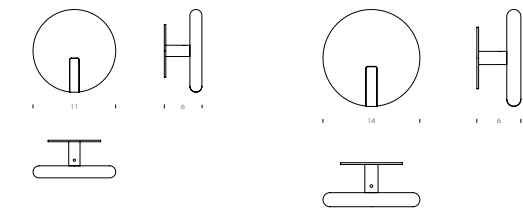

vanity

7493

Ø 31 H 75 cm

7410

Ø 41 H 168 cm

7493 - 7410

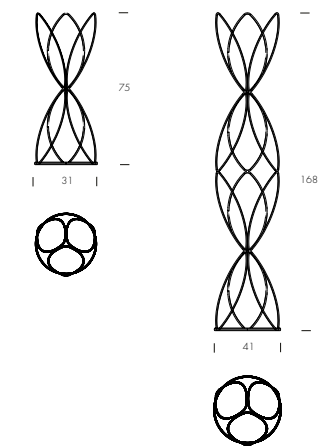

vela

6413

L 30 P 26 H 30 cm

6413



bely

7540

(P) L 64 P 2 H 88 cm  
(A) L 88 P 2 H 112 cm

7540

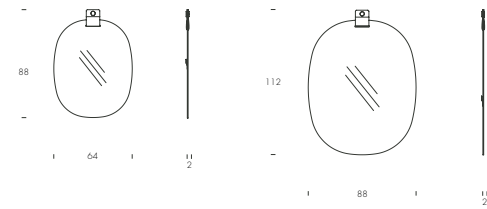

macrabè

7538

(P) L 100 P 5 H 100 cm  
(A) L 100 P 5 H 200 cm

7538

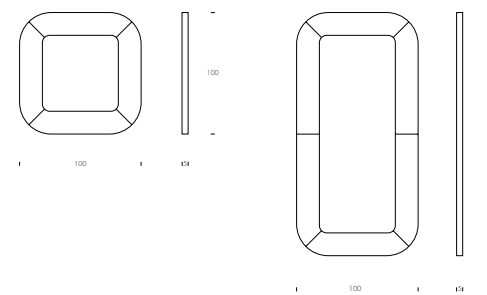

246

matrix

7539

L 85 P 3 H 53 cm

7539

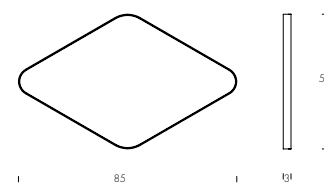

python

7542

(P) L 40 P 4 H 46 cm  
(A) L 60 P 4 H 69 cm  
(G) L 80 P 4 H 92 cm  
(D) L 120 P 4 H 135 cm

7542

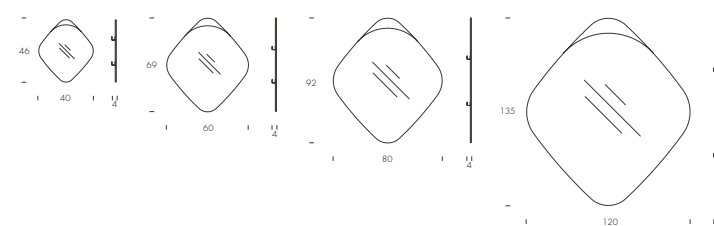

timeless

7543

(P) L 42 P 3 H 120 cm  
(A) L 42 P 3 H 160 cm

7543

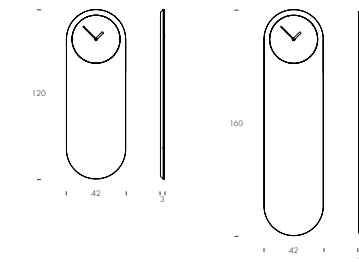

vega

7541

(P) L 61 P 6 H 61 cm  
(A) L 91 P 6 H 91 cm

7541

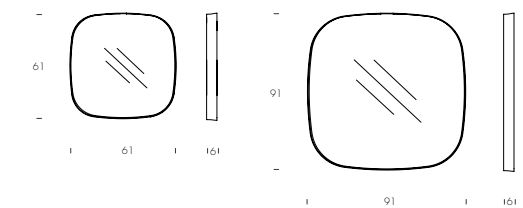

247

dali

---

**9116**

L 38 P 20 H 33 cm  
L 38 P 5 H 79 cm

**9116**

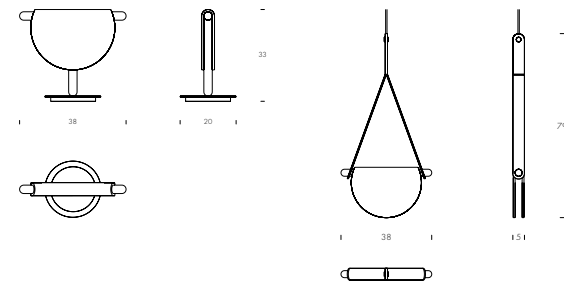

macrabè

---

**9118**

Ø 32 H 28 cm  
(P) Ø 22 H 26 cm  
(A) Ø 32 H 26 cm

**9118**

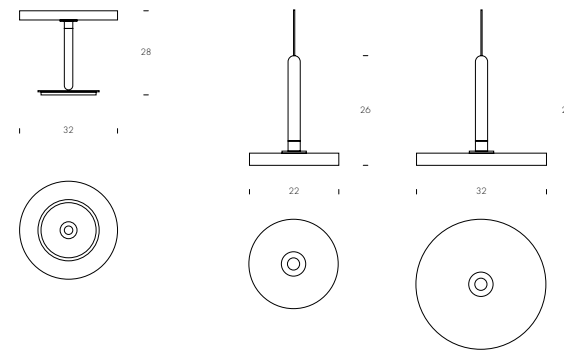

248

249

miss

---

**9117**

(P) L 43 P 36 H 150 cm  
(A) L 43 P 36 H 185 cm

**9117**

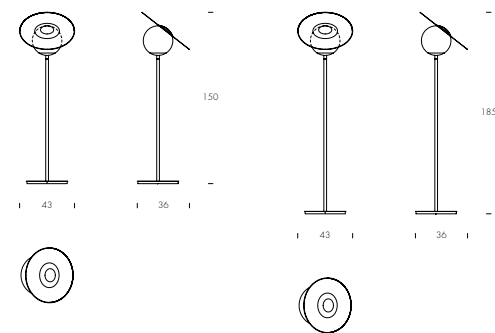

Fondata da Gianni Tonin più di 40 anni fa, TONIN CASA è stata sin dall'inizio esempio di passione, eleganza e ricerca nel settore arredamento.

Nel 1975 la sua attività principale era il commercio di scarpieri e mobili classici, pubblicando il primo catalogo nel 1982.

Il successo e la fiducia dei clienti fecero sì che nei primi anni '90 venisse avviata la produzione di mobili moderni, accompagnati dall'edizione di cataloghi dedicati e dall'espansione dell'area commerciale oltre il Triveneto.

Tonin Casa, da allora, è in costante sviluppo e crescita, impegnata nel commercio a livello mondiale e nell'esportazione dei valori Made in Italy, con prodotti sintesi di bellezza e funzionalità. Segni e tendenze che promuovono la tradizione del Design Italiano nel mondo.

Founded by Gianni Tonin more than 40 years ago, TONIN CASA since the very beginning has been a perfect example of passion, elegance and research in furniture area.

In 1975 its main activity was the production of shoe closets and classical furniture, and in 1982 the first catalogue was published.

Due to its success and clients' trust, production of modern furniture started in the beginning of '90s, accompanied by publishing of specific catalogues and the expansion to areas beyond Triveneto.

Since then Tonin Casa has been in a continuous development and growth engaging into worldwide sales and exporting the values of Made in Italy through the products which resume beauty and functionality. Signs and trends that promote the tradition of Italian Design in the world.

**Stampa:**

Grafiche Antiga

Stampato in Italia Maggio 2019

La ditta 'Tonin Casa divisione della Progetto Design International s.r.l.' si riserva la facoltà di modificare in qualunque momento e senza preavviso, le caratteristiche tecniche degli elementi usati nel presente catalogo.

Alcuni accessori presenti nelle immagini fotografiche non sono prodotti dalla ditta 'Tonin Casa divisione della Progetto Design International s.r.l.'. Si prega di far riferimento al listino prezzi.

La ditta 'Tonin Casa divisione della Progetto Design International s.r.l.' si riserva inoltre il diritto di apportare ai propri prodotti quelle modifiche che si riterranno necessarie o utili al fine di migliorarli senza pregiudicarne le caratteristiche essenziali.

È vietata ogni riproduzione totale o parziale in Italia e all'estero.

'Tonin Casa divisione della Progetto Design International s.r.l.' reserves the right to modify technical characteristics of the items shown in this catalogue, at any time and without notification.

Some of the accessories shown in the photos are not produced by 'Tonin Casa divisione della Progetto Design International s.r.l.'. Please refer to the price list.

'Tonin Casa divisione della Progetto Design International s.r.l.' also reserves the right to make any sort of modifications to its products, deemed necessary of useful in order to improve them without impairing their basic characteristics.

Total or partial reproduction of the products is prohibited in Italy and abroad.

progetto  
design



**Tonin Casa**  
divisione della  
Progetto Design International srl

via Palladio, 43  
35010, San Giorgio in Bosco (PD), Italy

t +39 049 9453300  
f +39 049 9450725

info@tonincasa.it  
c.f. P.iva IT03817150240