

# .detail3

the new contemporary

occasional furniture





Detail 3\_the new contemporary  
occasional furniture



Everything we do, just the way it is

There usually is a certain passion regarding what is seen from the distance. Distance reminds us of romance, yet it has a secondary effect: it hides, it avoids, it standardizes. Nothing could be further away from what we mean to give you. We could do it, if only we did not know how much time we spent making our designers' ideas real. We could do it, if we tried to make imperfect materials better, rather than choosing the best ones. We should do it, if we were not sure we took perfect care of every single detail. We will not do it. Everything we create is here in front of you, and we'd want you to see it, just the way it is.







# adachi

design\_Studio28

Adachi riprende le forme di un elegante alambicco, dallo stelo lungo e snello che si apre in un top in vetro temperato. A permettere la creazione di una forma così particolare, un materiale duttile e resistente come l'agglomerato di marmo.

Adachi reminds of an elegant alembic, with a long stem opening to hold the tempered glass top. Cultured marble - an extremely ductile and strong material - allowed to arrange such a peculiar shape.

Adachi напоминает элегантный перегонный куб с длинным открывающимся стеблем, удерживающим поверхность из закаленного стекла. Искусственный мрамор - чрезвычайно пластичный и крепкий материал - позволил получить такую своеобразную форму.

8155

Ø 50 H 63 cm  
(H) Ø 50 H 73 cm



Adachi 8155  
Coffee table:  
glossy champagne lacquered  
cultured marble base (560);  
transparent glass top (V\_81)

# adele

design\_Angelo Tomaiuolo

Il design di Adele lo rende perfetto per adattarsi a diversi luoghi di varie dimensioni. Un triangolo con struttura in metallo verniciato – bianco lucido, nero lucido o champagne lucido – la cui essenza contemporanea viene mitigata dal piano in noce canaletto, o rovere scuro termotrattato.

Adele's design makes it perfectly adaptable to every kind of room. A triangle held by a varnished metal structure – glossy white, or glossy black – whose contemporary essence slightly diminishes with the Canaletto walnut, or the dark, heat-treated oak top.

Дизайн Adele делает его идеальным решением для любого интерьера и пространства. Треугольник со структурой из окрашенного металла – это может быть глянцевый белый, глянцевый черный или глянцевый шампанский, – чья современная сущность смягчается столешницей и черного ореха или темного термообработанного дуба

6033

L 72 P 81 H 34 cm



Adele 6033  
Coffee-tables:  
matt white varnished metal structure (01);  
heat-treated dark oak top (16)



I colori e la forma, l'abbinamento di due triangoli a formare un elegante rombo. Adele è in grado di adattarsi agli ambienti più raffinati, e riesce in egual modo ad essere divertente e funzionale. Le linee precise al millimetro permettono di accostare agilmente i tavolini tra loro, o ad altri pezzi di arredamento, siano essi classici o moderni.

Colors and shape, a match of two triangles forming a diamond. Adele can be perfect for luxurious spaces, and at the same time be functional and entertaining. More than one can be put next to a sofa, side by side, one with the other, thanks to the perfectly smooth and precise finishing lines.

Цвета и форма, сочетание двух треугольников, формирующих изысканный ромб. Стол Adele способен вписаться в самый изысканный интерьер, оставаясь одновременно практичным и веселым предметом интерьера. Точность до миллиметра позволяет идеально прилегать столикам друг к другу или сочетать каждый из них отдельно с другими предметами интерьера, неважно, классическими или современными.



# aida

design\_Angelo Tomaiuolo

Come l'amore della principessa, anche Aida si fonda su due elementi estremamente diversi: una base in vetro trasparente, in tre linee rigide; un piano rivestito in legno noce canaletto, o rovere scuro termotrattato, tondeggiante. Una lavorazione complessa per armonizzare materie e disegni.

Just like the loves of the famous princess, this Aida is split between two very different elements: a see-through glass base, designed with three firm lines; a round Canaletto walnut, or dark heat-treated oak covered top. A complex manufacture, to harmonize materials and design.

Как и любовь принцессы, модель Aida также основана на двух разных элементах: основание из прозрачного стекла, которое продолжается тремя строгими линиями, и столешница с округлыми формами из ореха или термообработанного темного дуба. Это результат сложного процесса обработки, согласующего разные материалы и формы.

6037

L 49 P 47 H 50 cm

6038

L 93 P 90 H 34 cm



Aida 6037-6038  
Coffee-table / Side-table:  
extra-clear transparent glass structure (V\_100);  
Canaletto walnut top (14)



Aida 6037  
Side-table:  
extra-clear transparent glass structure (V\_100);  
Canaletto walnut top (14)



Dall'alto, vedendo un delicato disegno a tre linee che dal centro evadono verso i bordi. Il legno è perfettamente fuso nella base vetrosa. Ancora una volta, la precisione tecnica risulta fondamentale nella riuscita estetica. Le venature del legno, pazientemente disposte per controbilanciare le linee di fuga del vetro, completano Aida, rendendo questo tavolino un omaggio sia alla cultura che ai materiali italiani.

Look at it from the top, and you will see the delicate drawing: three lines moving from the center, to the sides. Wood perfectly melts into a glass base. Once again, technical precision reveals to be fundamental for the aesthetic. Wood grains, patiently put in order, so to counterbalance the glass' vanishing points, complete Aida, an homage to both Italian culture and materials.

Если рассматривать модель сверху, можно заметить, как три тонкие линии расходятся от центра к краям столика. Древесина прекрасно вливается в стеклянную структуру. Это еще один пример того, что точность технических приемов является ключевой для эстетического успеха изделия. Прожилки дерева, рисунок которых умело контрастирует с полосками стекла, делают модель Aida настоящей данью культуре и итальянским материалам.



# airone

design\_Studio Tonin Creatives

Un movimento che ricorda la leggiadria di un uccello; una struttura contemporanea, che gioca con spazi e geometrie. Un tavolino, con specchi e scomparti, per raggiungere una linea di essenziale bellezza.

A movement, to remind of a bird's gracefulness; a contemporary structure, playing with spaces and geometries. A coffee table, with mirrors and shelves, to reach an essential, beautiful design.

Движение, напоминающее грацию птицы; современная конструкция, игра с пространствами и геометрией. Журнальный столик с зеркалами и полками для получения существенного, красивого дизайна.

6272

L 46 P 36 H 68 cm



Airone 6272  
Swivelling coffee-table:  
matt white lacquered storage units (O1);  
mirroring supports

# alaric

design\_Andrea Lucatello

Alaric è una linea morbida ed essenziale, che rende protagonista la particolare lavorazione del vetro curvato. Lungi dall'asservire alla sola estetica, le curve e le rientranze di Alaric fungono da doppio ripiano e da portariviste.

Alaric is an essential and soft line, and is the best way to let the curved glassworking stand out. The manufacture needs not to be considered mere aesthetic, for curves and bends are thought to produce a double top, and a magazine-rack

Alaric — существенная и мягкая линия, и это лучший способ позволить гнтому стеклу выделиться. Производство не следует рассматривать лишь с эстетической стороны, так как изгибы и скручивания создают двойную поверхность, а также саму журнальную стойку.

6223

L 142 P 70 H 30 cm



Alaric 6223  
Coffee-table:  
curved transparent glass (V\_81)

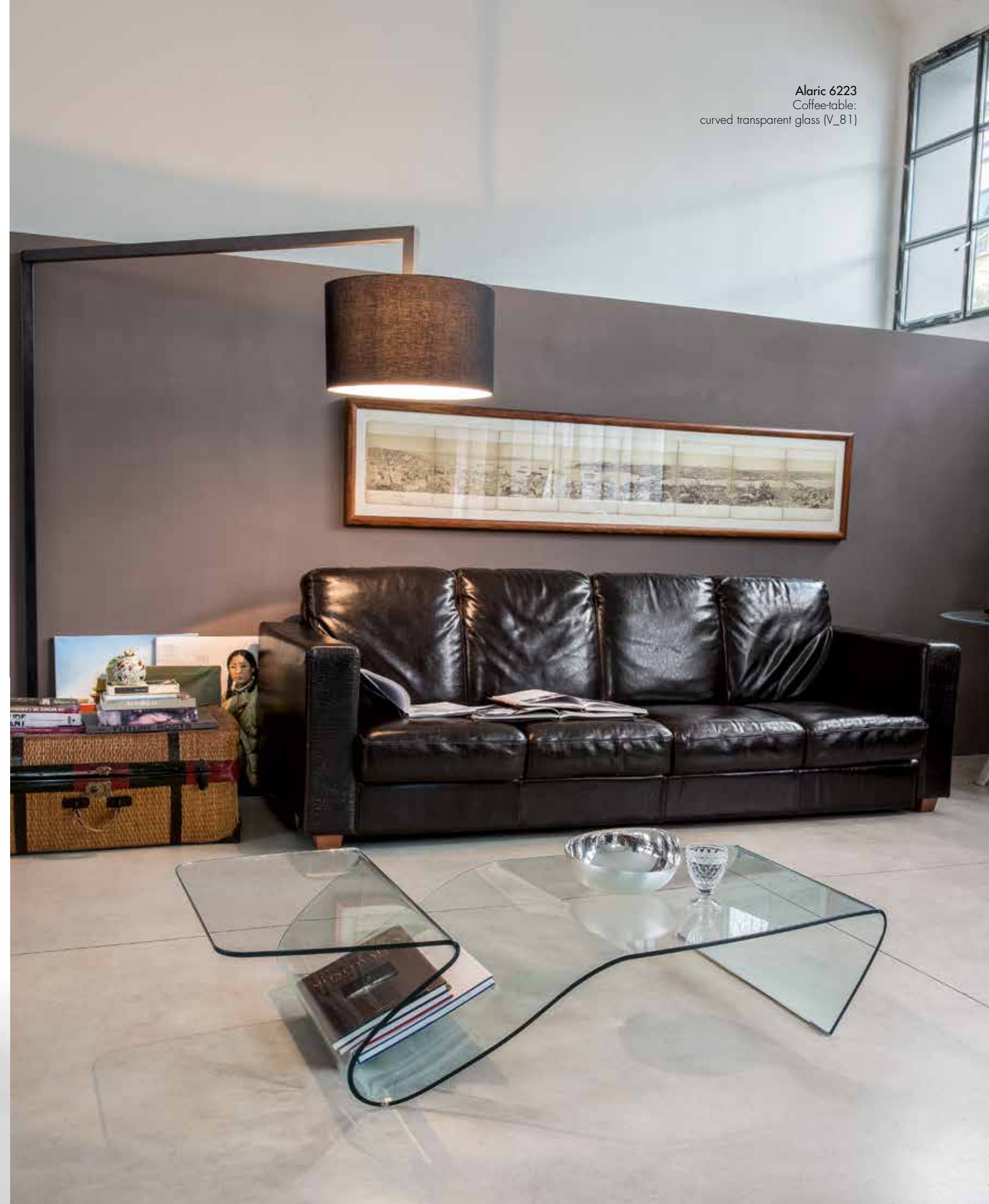

# alga

design\_Davide Bozzini

Alga nasce da un'idea di movimento, dalle linee morbide e pacate che si creano nel mondo sottomarino. Una struttura tubolare in metallo laccato che culmina con eleganti cerchi appendiabiti.

Alga was born from a concept of movement, from the underwater world's soft and quiet lines. It is a tubular, painted metal structure, culminating in elegant, round coathangers.

Alga родилась из концепции движения, мягких и спокойных линий подводного мира. Это трубчатая, окрашенная металлическая конструкция, представленная в виде элегантной, круглой вешалки для пальто.

7416

Ø 40 H 177 cm



Alga 7416  
Coat-hanger:  
lacquered matt beige (36)



Alga 7416  
Coathangers:  
matt stone bronze (83) &  
matt Agata pink (68)



# alissa

design\_Studio Tonin Creatives

Il vetro curvato è la materia sulla quale si fonda Alissa, tavolino dalla forma leggera e delicata, declinabile nelle colorazioni predilette da ciascuno: trasparente, bronzo trasparente, fumé, extra-chiaro.

Curved glass is everything, in Alissa coffee table: it is light and delicate, and it can satisfy everyone's taste: be it transparent, transparent bronze, or extra-clear.

Гнущее стекло в журнальном столике Alissa — это многое: он легкий и тонкий, и может удовлетворить любой вкус: будь-то прозрачный, из прозрачной бронзы или экстра-прозрачный.

6806

(E) L 117 P 78 H 37 cm  
(RM) L 120 P 64 H 37 cm

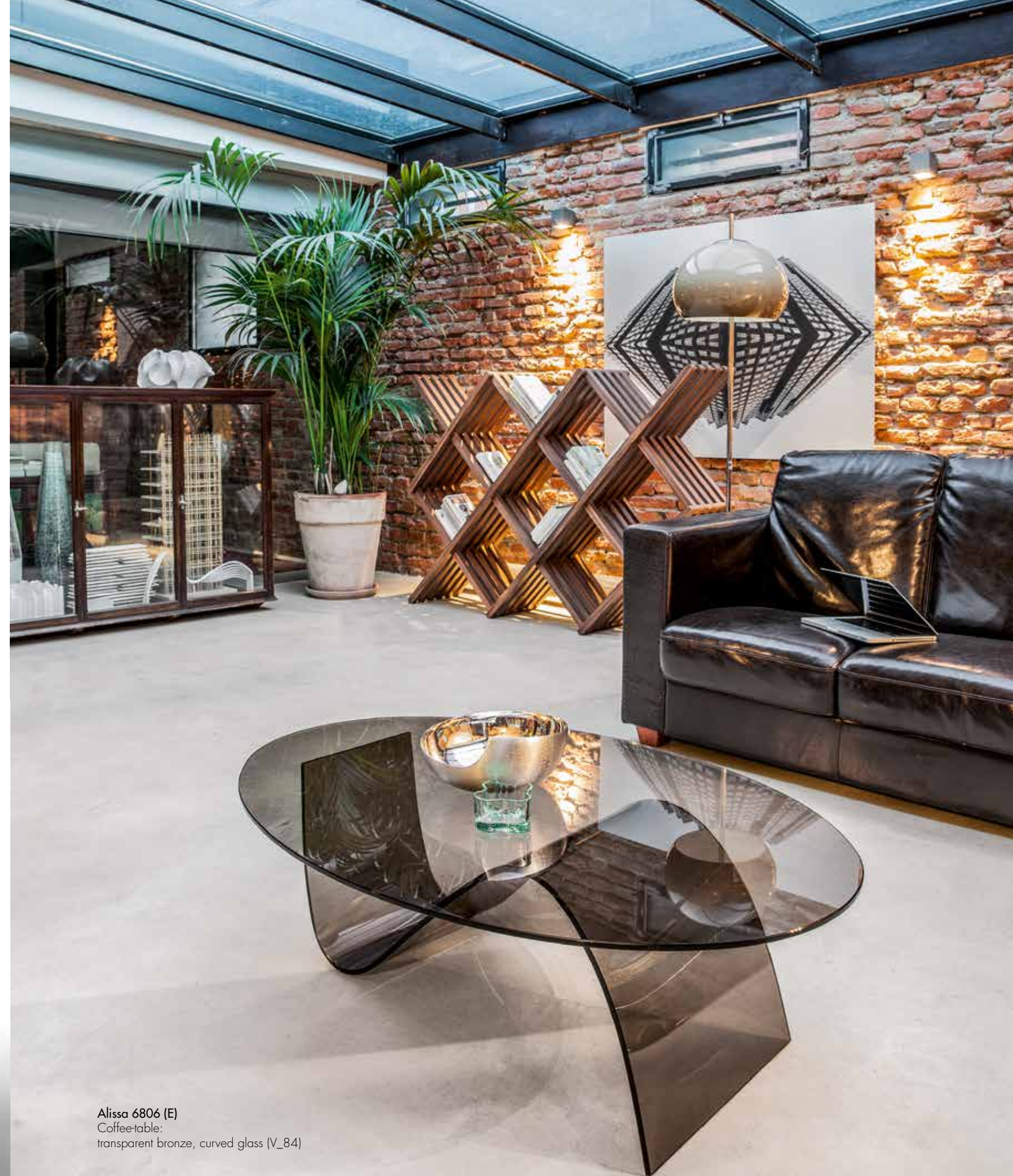

Alissa 6806 (E)  
Coffee-table:  
transparent bronze, curved glass (V\_84)

# amaranto

design\_Studio28

Un tavolino che unisce la leggerezza del vetro curvato ad un ripiano in vetro temperato, o legno. Due stili diversi e due materiali immediatamente riconoscibili, che rendono la zona living perfetta ed elegante.

A coffee table that combines the lightness of curved glass, with a tempered glass, or wooden shelf. Two different styles and two different materials that are immediately recognisable, materials to make your living-room perfect and elegant.

Журнальный столик, который сочетает в себе легкость гнутого стекла с полкой из закаленного стекла или дерева. Два разных стиля и два различных материала, которые очень легко распознать, чтобы сделать вашу гостиную совершенной и элегантной.

6811

L 130 P 68 H 37/17 cm



Amaranto 6811  
Coffee table:  
transparent curved glass (V\_81);  
Canoletto walnut shell (14)

# amburgo

design\_Studio28

Tavolini e servetto Amburgo giocano sulla rotondità delle linee, alleggerita dagli spazi lasciati liberi nella struttura. I tubi in metallo cromato salgono a reggere i top in vetro temperato nero, bianco o beige.

Amburgo coffee and side-tables play with smooth lines, a space that gets lightened by the structure's empty spaces. The chromed metal tubes go up to hold the black, white or beige tempered glass top.

Журнальный и приставной столик Amburgo играет с плавными линиями, пространством, которое получает освещение от пустых мест в конструкции. Трубки из хромированного металла или цвета каменной бронзы направлены вверх, удерживая поверхность из черного, белого, бежевого закаленного стекла или керамогранита.

6285

Ø 55/40 H 55 cm

6286

Ø 70/50 H 40 cm

6287

Ø 100/80 H 30 cm



**Amburgo 6287**  
Coffee-table:  
chromed metal structure (72);  
extra-clear white glass top (V\_101)



Amburgo 6287- 6285  
Coffee-table & Side-table:  
chromed metal structure (72);  
black & extra-clear white glass tops (V\_2;V\_101)

# amira

design\_Davide Bozzini

Tavolini preziosi ed elegantissimi, che arricchiscono ogni ambiente di cui divengano parte. Due diverse altezze, con basi in ceramica e top in MDF rivestito in legno noce canaletto, o rovere. Diverse colorazioni, accoppiate a creare la combinazione perfetta: bianco e viola opachi o lucidi; bianco e verde salvia; bianco e nero lucidi, uniti all'oro.

These are precious and amazingly elegant coffee tables, made to enrich their surroundings. Two different sizes are available, with ceramic bases and wood covered MDF tops. Various colors, married to create the perfect combination: purple and white, glossy, or matt; white and green sage; glossy white and black, combined with gold.

Ценные и невероятно изысканные столики обогащают интерьер, становясь его неотъемлемой частью. Две разных высоты, основание из керамики и столешница из МДФ со шпонировкой деревом: орех или дуб. Сочетание контрастных цветов создает идеальный баланс: глянцевые или матовые белый и фиолетовый, белый и зеленый шалфей, глянцевый белый и черный в сочетании с золотом.

6273

Ø 61 H 36 cm

6274

Ø 45 H 50 cm



Amira 6273-6274  
Coffee-table and Side table:  
glossy white/glossy gold base (303);  
Canaletto walnut top (14)

Un'altra principessa orientale, e la sua ancella, lussuose ed eleganti nella loro veste nera. Come due vasi inestimabili, da unirsi assieme creando un'armonia di forme perfetta. Infine, un tocco di luce e preziosità alla base, a coronare le curve delicate e sinuose: Amira viene immersa nell'oro zecchino, degna calzatura di una regina.

Another princess from the East, and her maid, luxurious and elegant in their black dresses. Just like two priceless vases, they shall stay together, to be perfectly symphonic. Lastly, a hint of light and preciousity at the base, to crown their sinuous and delicate curves: we soak Amiras in pure gold, an adequate sandal, for a queen.

Перед нами еще одна восточная принцесса и ее служанка, роскошные и утонченные в своих черных одеждах. Как две бесценных вазы, которые вместе создают гармонию совершенных форм. И наконец, штрих блеска и ценность основания довершают нежные роскошные изгибы: Amira покрывается позолотой, достойной королевы.



# andorra

design\_Nicola Tonin

Una lavorazione morbida e snella per la base di Andorra: un circolo che si snellisce al centro e si riapre verso il top, anch'esso rotondo. Un'idea di leggerezza e flessibilità che si può sfruttare in ogni ambiente.

Andorra's base undergoes a soft and thin manufacture: a circle, getting thinner and then opening again towards the round top. An idea of lightness and flexibility that can be used in widely different rooms.

Основание Andorra обладает мягкой и тонкой обработкой: круг, становится тоньше, а затем снова открывается по направлению к круглой поверхности. Идея легкости и гибкости, которые могут быть использованы в самых разных помещениях.

6293

Ø 40/40 H 52 cm



Andorra 6293  
Coffee-table:  
matt white metal base (01);  
extra-clear white glass top (V\_101)





Andorra 6293  
Coffee-table:  
chromed metal base (72);  
black glass top (V\_2)





# andra

design\_Studio Tonin Creatives

Andra si compone di linee verticali, una cintura circolare in filo di metallo verniciato, bianco per brillare più luminoso, nero per l'eleganza. Il metallo si unisce al vetro del piano, temperato ed acidato, anch'esso disponibile sia in bianco che in nero.

Andra's composition was developed in vertical lines, and a circular, varnished metal rod as a belt: it can be white, to brightly shine, or black, to exude elegance. The structure's metal is put together with the tempered, frosted glass top. The color may be white, or black, as well.

Andra состоит из вертикальных линий, круговой ленты из окрашенного металла, белый блеск которого подчеркивает элегантность черного фона. Металл соединяется с листовым каленым травленным стеклом, которое может быть белого или черного цвета.

## 6934

(A) L 90 P 60 H 30 cm  
(G) L 120 P 86 H 30 cm

## 6936

(P) L 50 P 36 H 64 cm



Andra 6934 (A) - 6936 (P)  
Coffee-table and Side table:  
matt white structure (01);  
extra-clear white frosted glass top (V\_601)



Un'affascinante gabbia che si apre al centro, chiusa e libera ad un tratto. La luce crea giochi decisi, chiare strisce verticali ed un piano orizzontale opaco, tondeggiate, questo, perché i designer di Tonin Casa non si limitano mai ad una sola dimensione.

A fascinating cage, opening at the middle, closed and wide at the same time. Light here creates peculiar effects, passing through Andra's vertical lines, and a matt, round top. Round, because Tonin Casa's designer never work on only one dimension.

Пленительная клетка, открытая в центре: одновременно и свобода и плен. Четкий рисунок игры света, светлые вертикальные полосы и горизонтальная поверхность, непрозрачная, скругленная... Все это потому, что дизайнеры Tonin Casa не ограничиваются только одним измерением.



# anemone

design\_Studio Tonin Creatives

Come la pianta marina da cui prende ispirazione, Anemone è un tavolino che lascia intravedere le sue forme, ma nasconde e protegge una zona contenitrice per i vostri oggetti più preziosi. Una struttura in legno curvato copre il ripiano in legno o vetro, spezzando una linea continua per creare ritmo e complessità. Le versioni disponibili, come singoli tavolini e servetti, o come tris di tavolini, permettono ad Anemone di porsi nei luoghi più disparati.

Just like the aquatic plant it shares its name with, Anemone allows to see through its shapes, but at the same time it hides and protects a storage area thought for your most precious ornaments. A curved glass structure covers the wooden, or glass shelf, inserting a horizontal line that provides rhythm and complexity. Many different versions are available: single coffee-tables, or side-tables, and sets of three side-tables.

Так же, как водное растение, с которым он делит свое название, Анемоне позволяет смотреть через свои формы, но в то же время он скрывает и защищает область для хранения, предназначенную для ваших самых драгоценных предметов декора. Конструкция из гнутого металла покрывает деревянную или стеклянную полку, вставляя горизонтальную линию, которая обеспечивает ритм и сложность. Доступно много разных версий: одинарный журнальный столик или приставные столики и комплекты из трех приставных столиков.

6829

L 52 P 44 H 45 cm

6846

L 40 P 40 H 37 cm  
L 48 P 44 H 41 cm  
L 56 P 48 H 45 cm

6850

L 110 P 60 H 37 cm



Anemone 6829  
Coffee-table:  
transparent bronze curved glass (V\_84);  
Canaletto walnut shelf (14)



Anemone 6850  
Coffee-table:  
transparent bronze  
curved glass (V\_84)



Anemone 6846  
Set of 3 side tables:  
transparent bronze curved glass (V\_84)

# ariel

design\_Studio Tonin Creatives

Una spirale che si sviluppa verso l'alto, con tasselli di vetro che rifrangono la luce e giocano con riflessi e colori. Ariel unisce la rotondità di base e piano, all'algida texture del vetro.

A spiral developing upwards, made of thin glass bricks that provide light refraction, playing with colors and reflections. Ariel combines the base and top's round shape, with the glass' snowy texture.

Спираль, направленная вверх, изготовлена из тонких стеклблоков, которые обеспечивают преломление света, играя цветами и отражениями. Ariel сочетает в себе основание и поверхность круглой формы с белоснежной текстурой стекла.

6814

Ø 60 H 36 cm

6832

L 100 P 60 H 39 cm



Ariel 6814  
Coffee-table:  
transparent glass (V\_81)

# arona

design\_Andrea Lucatello

Arona sembra quasi veleggiare sopra la propria base. Come due vele, due ali in vetro curvato, che poggiano lievi su di un supporto rotondo in legno. Un'eleganza cortese e raffinata.

Arona almost seems to glide over its base. Just like two canvas, two curved glass wings, lightly standing on top of a round, wooden base. A refined and quiet elegance.

Кажется, что Arona почти скользит по основанию. Так же, как два холста, два крыла из гнутого стекла, легко размещаются на круглом, деревянном основании. Изысканная и спокойная элегантность.

6212

L 145 P 65 H 30 cm



Arona 6212  
Coffee-table:  
Canaletto walnut base (14);  
extra-clear transparent  
glass shelves (V\_100)



# beside

design\_Angelo Tomaiuolo

Un'unica linea forma Beside, tavolino di un'essenzialità ad un tempo atavica e contemporanea, la cui punta di diamante è rappresentata dal connubio tra funzionalità e bellezza estetica.

BESIDE is made out of just one line: this table shows an ancestral and contemporary essentiality, at once. Its best characteristic is the combination of functionality and aesthetic beauty.

BESIDE сделан из одной линии: этот стол демонстрирует наследственную и современную сущность одновременно. Его лучшей характеристикой является сочетание функциональности и эстетической красоты.

8167

(DX) L 50 P 49 H 53 cm  
(SX) L 50 P 49 H 53 cm



Beside 8167  
Side table,  
transparent fumé  
curved glass (V\_85)

# book

design\_Nicola Tonin

Una raggiera in pannelli laccati si apre su di un elegante base, un dosso in legno massiccio. Lo spazio utile a poggiare le riviste prende una forma diversa, innovativa, che gioca su colori e linee, su vuoti e pieni.

Radial, lacquered panels open onto an elegant base, a solid wood element. The space was thought to contain books and magazines, and it takes a different, innovative shape, playing with lines and colors, empty and filled spaces.

Сегментные, лакированные панели открываются на элегантном основании; элемент из массива дерева. Его пространство предназначено для хранения книг и журналов, и оно принимает другую — инновационную форму, играя с линиями и цветами, пустых и заполненных пространств.

7492

L 54 P 35 H 30 cm

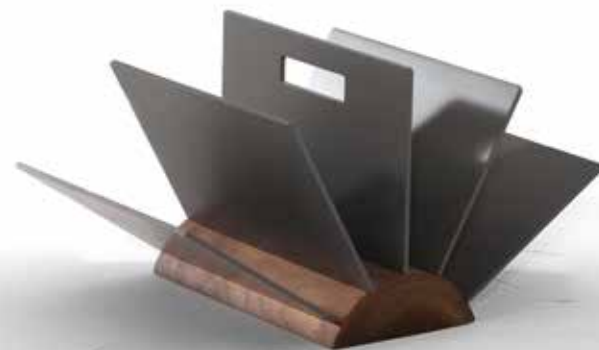

## Book 7492

Magazine rack.  
Ash wood structure: painted  
Canaletto walnut (1.4);  
Agata pink layers (68)







**Book 7492**  
Magazine rack.  
Ash wood structure: painted  
Canaletto walnut (14), natural oak (17);  
layers: white (01), Agata pink (68), matt champagne (60)

# central

design\_Studio 28

Una perfezione geometrica che invita alla personalizzazione, alla scelta tra legno o vetro, tra una cromatura snella e conviviale, ed una più elegante patina bruna. Un tavolino da caffè, un servetto, un pezzo di arredamento capace di rendere unico il vostro living.

A geometric perfection, inviting customization, asking you to choose between wood and glass, between a thin, convivial chrome, and a more elegant dark veil. A coffee table, a side table, a piece of furniture capable of making your living room, just unique.

Геометрическое совершенство и привлекательная индивидуализация просят вас сделать выбор между деревом и стеклом, между тонким, праздничным хромом и более элегантной темной вуалью. Журнальный столик, приставной столик, предмет мебели, способный сделать вашу гостиную просто уникальной.

**6281**

L 100 P 100 H 30 cm

**6282**

L 50 P 50 H 50 cm

**6284**

L 100 P 55 H 30 cm



Central 8281-6282  
Side-table & Coffee-table.  
Chromed metal structure (72);  
Statuario altissimo marble  
porcelain effect top (VO1P)

# celine

design\_Studio Tonin Creatives

Un piccolo tavolino dal piano a tre lati, poggiato su di una base treppiede in metallo verniciato. Gli equilibri si concentrano sui colori ed i materiali, in toni pacati: piano in rovere massello, naturale o castagno, su una base in nero opaco; piano in MDF laccato, bianco opaco come la sua base.

A small coffee table, with a three-sided top, put on a varnished metal trivet. We balanced colors and materials, placidly: a solid, natural or lacquered chestnut oak, on a matt black base; matt white lacquered MDF top, on a matt white base.

Небольшой столик, столешница которого опирается на треног из окрашенного металла. Равновесие сконцентрировано на цвете и материалах в спокойных тонах: столешница из массива дуба естественного цвета или под каштан и основание из матового черного. Столешница из МДФ с лакированным покрытием с белым матовым основанием.

6021

L 42 P 44 H 55 cm  
(H) L 45 P 44 H 65 cm



Celine 6021 - 6021(H)

Side tables:  
matt black varnished  
metal structure (O2);  
matt black (O2) and solid oak,  
chestnut painted (LM\_20) tops

Céline si pensa in coppia, in diverse altezze, per giocare su colori e spazi. Grazie all'utilizzo di diversi materiali, due tavolini Céline possono fondersi e divenire il compagno perfetto di qualsiasi divano, o poltrona.

Céline was thought to be used in couples, in two different sizes, playing with colors and spaces. The different materials of which they are made, make Céline coffee tables capable of melting together and becoming the perfect partners for any sofas, or armchair.

Céline воспринимается в паре. Элементы разной высоты, играющие с цветами и пространством. Благодаря использованию различных материалов оба столика Céline можно объединить и сочетать с любым диваном или креслом.



# chakra

design\_Angelo Tomaiuolo

Ispirato all'equilibrio e al gioco di forze interne che caratterizza l'anima, Chakra si sviluppa con fasce verticali in vetro, che si completano in un top, e che dal basso nel medesimo momento sorreggono la base. Un equilibrio che continua ed evolve grazie all'accostamento con il legno del piano, in noce Canaletto, o rovere scuro.

Inspired by the soul's inner balance and forces, CHAKRA is developed with glass, vertical strips, that reach completion on the top, and at the same time provide a support for the base. A balance that continues and evolves thanks to the top's material: Canaletto walnut, or dark oak.

Вдохновленный внутренним равновесием души и силами, столик CHAKRA выполнен со стеклом, вертикальными полосами, которые заканчиваются на поверхности, и в то же время обеспечивают поддержку основанию. Баланс, который продолжается и развивается благодаря материалу поверхности: грецкий орех Каналетто или темный дуб.

6875

L 85 P 80 H 38 cm

6876

L 46 P 42 H 50 cm



Chakra 6875 -6876  
Coffee table & Side table:  
extra-clear transparent  
glass structure (V\_100);  
Canaletto walnut top (14)



**Chakra 6875 -6876**  
Coffee table & Side table:  
fumé grey transparent  
glass structure (V\_85);  
Canaletto walnut top (14)

# cora

design\_Davide Bozzini

Un unico design per un tavolino o un più piccolo servetto; una struttura snella e affusolata, in cromo bronzato oppure ramato; un classico piano rivestito di noce o rovere scuro termotrattato: Cora.

One unique design, for a smaller than a coffee table piece; a slim and tapered, bronzed or coppered chrome structure; a classic top, covered in Canaletto walnut, or heat-treated oak: Cora.

Уникальный дизайн журнального столика или пьедестала, обтекаемая коническая структура цвета хромированной бронзы или меди. Классическая столешница, шпонированная орехом или темным дубом. Это Cora.

## 6035

(P) Ø 40 H 48 cm  
(A) L 80 P 40 H 38 cm  
(G) L 110 P 40 H 38 cm



Cora 6035(P)  
Coffee-table & Side-table:  
coppered chrome structure (75);  
Canaletto walnut top (14)





**Cora 6035**  
Coffee-tables and Side table:  
black chrome (76) and coppered chrome  
structure (75); Canaletto walnut tops (14)



# cortes

design\_Studio28

Porta-TV orientabile in legno, dalle linee precise e geometriche. Struttura in metallo e ripiano in vetro temperato, per adattarsi agli spazi più contemporanei.

Revolving TV-stand. The metal structure and the tempered glass shelf are thought to fit in the most contemporary living-rooms.

Вращающаяся тумба под телевизор. Металлическая конструкция и полка из закаленного стекла подойдут к самым современным гостиным.

7095G

L 130 P 42 H 125 cm



Cortes 7095G  
TV Stand:  
carbon grey structure (10);  
Canaletto walnut panel (14);  
transparent fumé glass shelf (V\_85)



# CRUZ

design\_Nicola Tonin

Cruz è un tavolino, o un servetto, in cui la modernità della base si fonde con il naturale calore del piano. Una struttura tubolare in metallo si intreccia e sale a raggiungere il top in legno.

Cruz is a coffee-table, or a side-table, whose modernity melts with the natural warmth of its top. The metal tubes forming the structure cross over each other, and reach the wooden top.

Cruz — журнальный или приставной столик, чья современность тает с естественным теплом его поверхности. Металлические трубы, образующие конструкцию, перекрещиваются друг с другом и достигают деревянной поверхности.

6878

L 122 P 42 H 35 cm

6879

L 42 P 42 H 50 cm



Cruz 6878-6879

Coffee table & Side Table:  
stone bronze structure (83);  
Canaletto walnut wood top (14)





**Cruz 6878-6879**  
Coffee-table and Side table:  
coppered chrome structure (75);  
heat-treated dark oak tops (16)

# detroit

design\_Studio28

Un tavolino pensato per accompagnare un morbido divano, occupando poco spazio e creando un punto di appoggio esteticamente impeccabile, e funzionale.

This coffee-table was thought to be partners with a soft sofa, occupying as little space as possible, and creating an aesthetically impeccable and functional comfort zone.

Этот журнальный столик предполагался для дополнения мягкого дивана, занимая по возможности минимум места, и создавая эстетически безупречную и функциональную зону комфорта.

8156

L 50 P 50 H 50 cm  
(H) L 50 P 50 H 61 cm



**Detroit 8156**  
Coffee-table:  
black chrome structure (76);  
Canaletto walnut top (14)

# dubai

design\_Studio28

Lo splendore di Dubai riportato in un tavolino contemporaneo, particolare e lussuoso: la base in agglomerato di marmo, con la sua forma che unisce rotondità di linee e gioco di spazi, sorregge uno splendido piano in vetro temperato.

DUBAI's magnificence was brought to this contemporary peculiar, luxurious coffee-table; the cultured marble base, shaped in a round and smooth pattern, holds a wonderful, tempered glass top.

Великолепие DUBAI было доведено до этого современного своеобразного, роскошного журнального столика; основание из искусственного мрамора, сформированное в круглой и гладкой модели, имеет прекрасную поверхность из закаленного стекла.

6608

L 120 P 70 H 38 cm



Dubai 6608  
Coffee-table:  
cultured marble base - turquoise blue RAL finishing;  
extra-clear transparent glass top (V\_100)

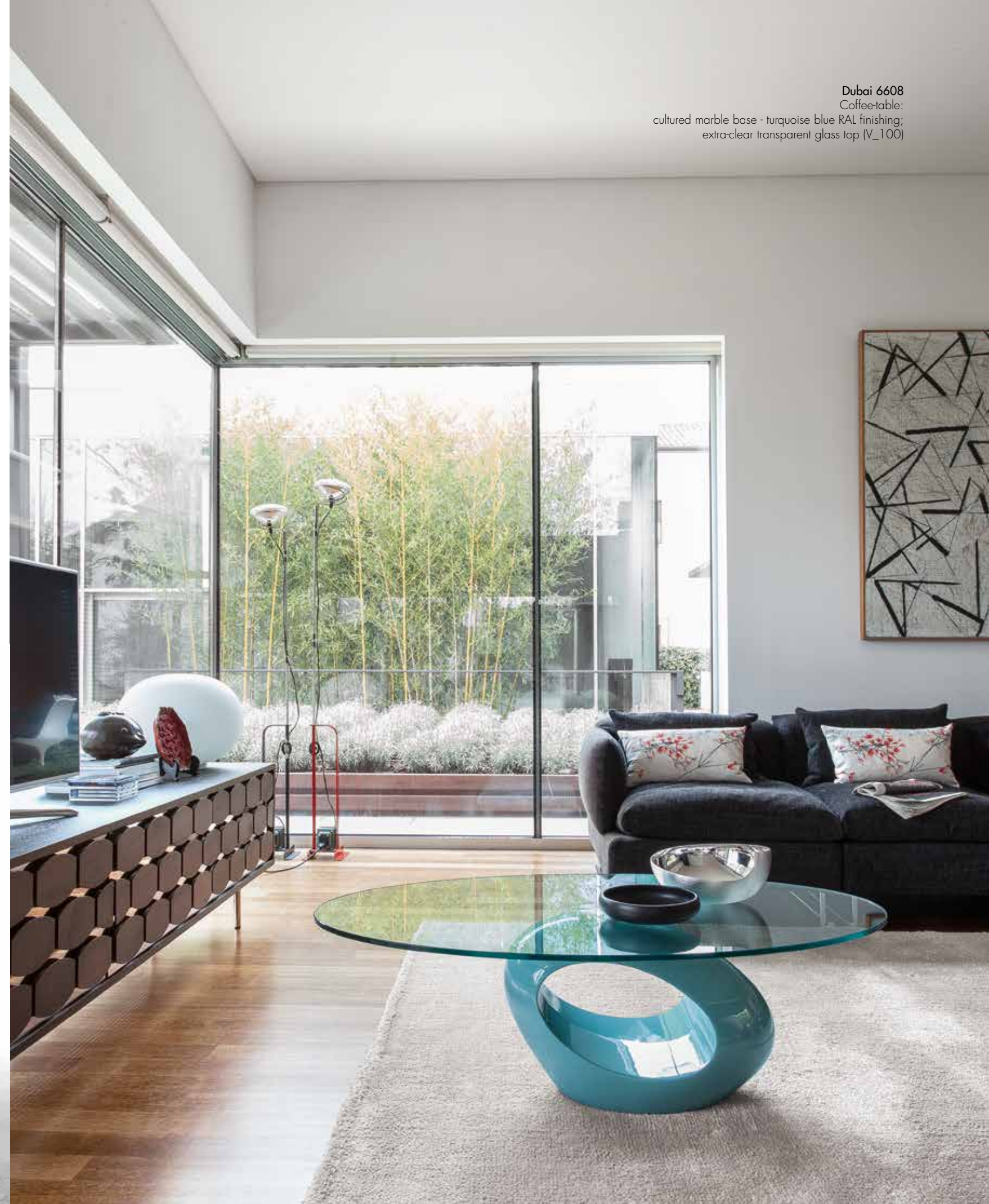

Dubai 6608  
Coffee-table:  
glossy black cultured  
marble base (502);  
black serigraphy glass top (V\_2)



# fly

design\_Angelo Tomaiuolo

Pratico, elegante, e dalla linea morbida: Fly è un portariviste che si arricchisce di un rivestimento in eco-pelle, e che permette moltissime variazioni di colore.

Practical, elegant and smooth: FLY is a magazine rack, enriched by an eco-leather covering that allows many different color variations.

Практичная, элегантная и гладкая: FLY — это журнальная стойка, дополненная покрытием из эко-кожи, обеспечивающая множество различных цветовых вариаций.

7491

L 65 P 38 H 28 cm



Fly 7491  
Magazine Rack:  
aubergine purple eco-leather [S\_77]

# ios

design\_Nicola Tonin

Innovativo tanto nel design che nell'uso del polietilene, lo vive delle sue varianti di colore, nella struttura, nel piano in plexiglass o legno, e nella versione con vano porta-bottiglie. Un'ulteriore possibilità viene offerta dalla versione con luce interna, che lo rende un oggetto ancor più vivo e futuristico.

Innovative in both design and manufacture (the polyethylene mould), IOS comes to life in its own color variations, in the structure, in the perspex, or wooden top, and in the bottle-holder version. A further chance is given by the version with built-in light, which makes it an even more alive and futuristic object.

Инновации как в проектировании, так и в производстве (полиэтиленовая форма): IOS оживает в своих собственных цветовых вариациях, в конструкции, в плексигласе, деревянной поверхности и в версии с бутылкодержателем. Еще один шанс дается версией со встроенным светом, что делает его еще более живым и футуристическим объектом.

8191

L 47 P 51 H 50 cm  
(PB) L 47 P 51 H 50 cm  
(PF) L 47 P 51 H 55 cm Q  
(PL) L 47 P 51 H 50 cm Q  
(BL) L 47 P 51 H 50 cm



ios 8191 - Kos 8190  
Side-table - Coffee-table:  
matt white polyethylene (01);  
transparent grey fumé plexiglass top (X\_85)



**los 8191 (PF)**  
Side tables:  
matt white polyethylene (01) &  
matt anthracite (64) structure;  
Fabric covered cushion: mud Ninfea  
fabric (TO\_51) & turquoise blue (TO\_40)



**los 8191 (PB)**  
Side table:  
matt white polyethylene structure (01)  
with storage; bottle holder,  
transparent plexiglass top (X\_81)



ivy

design\_Davide Bozzini

Discreti, funzionali ed eleganti: gli appendiabiti Ivy possono decorare una parete esattamente nella misura da voi desiderata.

Discreet, functional and elegant: IVY coathangers can decor a wall, precisely as much as you need.

Сдержанные, функциональные и элегантные: вешалки для пальто IVY могут украсить стену, точно так, как вам нужно.

7418

L 14 P 8 H 18 cm  
L 12 P 7 H 14 cm

Ivy 7418  
Coathangers:  
2-tone methacrylate,  
glossy white (501)



# kos

design\_Nicola Tonin

Innovativo tanto nel design che nell'uso del polietilene, Kos vive delle sue varianti di colore, nella struttura, nel piano in plexiglass o legno, e nella versione con vano contenitore. Un'ulteriore possibilità viene offerta dalla versione con luce interna, che lo rende un oggetto ancor più vivo e futuristico.

Innovative in both design and manufacture (the polyethylene mould), KOS comes to life in its own color variations, in the structure, in the perspex, or wooden top, and in the bottle-holder version. A further chance is given by the version with built-in light, which makes it an even more alive and futuristic object.

Инновации как в проектировании, так и в производстве (полиэтиленовая форма): KOS оживает в своих собственных цветовых вариациях, в конструкции, в плексигласе, деревянной поверхности и в версии с бутылкодержателем. Еще один шанс дается версией со встроенным светом, что делает его еще более живым и футуристическим объектом.

8190

L 112 P 95 H 33 cm ◊  
(l) L 112 P 95 H 33 cm



Kos 8190

Coffee-tables:  
matt white (01), matt beige (36),  
matt anthracite (64) & matt tortola (60)  
polyethylene structure.

Plexiglass tops:  
transparent (X\_81), transparent grey tinté (X\_85),  
black (X\_02) & opaline white (X\_62)



Kos 8190  
Coffee-tables:  
matt white polyethylene (01);  
transparent grey fumé plexiglass top (X\_85);  
opaline white top (X\_62)



**Kos 8190 - los 8191**  
Coffee-table and Side tables:  
Bronze, Corten effect (54) and dove grey polyethylene; (60)  
Canaletto walnut tops (14)

# log

design\_Daniel Rode

Tre ellissi si intrecciano, su tre piani diversi, a formare un tavolino dalla linea innovativa ed elegante. Le combinazioni di materiali e colori, offerte dai marmi e dai laccati, lo rende un punto focale perfetto della zona living.

Three ellipses revolve on three different levels, composing the innovative and elegant line of this coffee-table. The combinations of colors and materials, offered by marble, and lacquered wood tops, make it the perfect focal point of your living-room.

Три эллипса вращаются на трех различных уровнях, образуя инновационную и элегантную линию этого журнального столика. Комбинации цветов и материалов, предлагаемых мрамором и поверхностями из лакированного дерева, делают его идеальным центром внимания вашей гостиной.

6019

L 105 P 100 H 40 cm



Log 6019  
Coffee-table:  
stone bronze metal structure (83);  
tops: Emperador marble,  
Agata pink and Canaletto walnut (A)

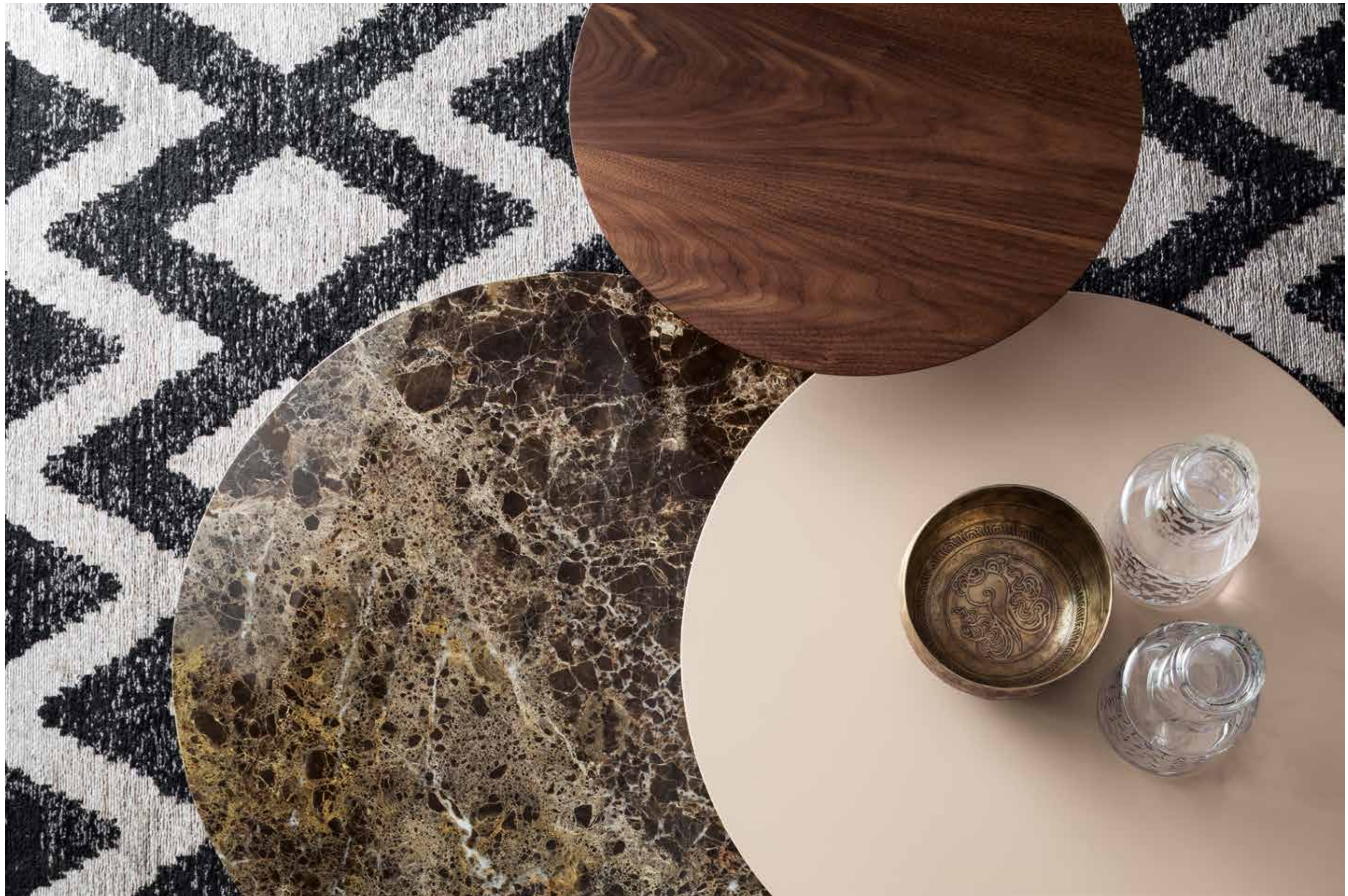

**Log 6019**  
Coffee-table:  
stone bronze metal structure (83);  
tops: Emperor marble,  
Agata pink and Canaletto walnut (A)

# logos

design\_Andrea Lucatello

Pensato per avere la funzionalità di un luogo di lavoro, e la bellezza di un oggetto di design, Logos unisce una struttura metallica, fresca e moderna, con un piano in legno ed un inserto in pelle, dal richiamo più classicamente elegante.

LOGOS was thought to unify a workplace functionality, and a design-product's beauty. It combines a metal, fresh and modern structure, with a wooden top and a leather insert - which are more classic and elegant.

Предназначение LOGOS — унифицировать функциональность рабочего места и красоту дизайнерского продукта. Он сочетает в себе металл, свежую и современную конструкцию с деревянной поверхностью и кожаной вставкой — самыми классическими и элегантными деталями.

7005

L 135 P 53 H 72 cm



Logos 7005  
Writing desk:  
stone bronze metal structure (83);  
Canaletto walnut top (14)



# maki

design\_Angelo Tomaiuolo

Un servetto dalla forma particolare, che si apre compatto verso l'alto, nel punto in cui il polietilene della struttura si unisce al legno del top. Maki è anche un contenitore, e un oggetto per illuminare la vostra stanza, nella versione con luce.

A peculiar shape forms this side-table: it opens, thick, on the upper part, in the junction between the polyethylene structure and the wooden top. MAKI is also a container, or an object to light your room.

Этому приставному столику присуща своеобразная форма: он демонстрирует массивную часть сверху, на стыке между полиэтиленовой структурой и деревянной поверхностью. MAKI — это также контейнер или объект для освещения вашей комнаты.

6234

Ø 42/27 H 51 cm  
(l) Ø 42/27 H 51 cm



**Maki 6234**  
Side tables.  
Structures: white polyethylene (01);  
Tops: natural oak (17)  
and Canaletto walnut (14)



Maki 6234 - 6234L  
Side tables.  
Structures: opaline white (48)  
with internal light,  
and pastel light blue (07);  
Tops: transparent top (X\_81)  
and Canaletto walnut (14)



Maki 6234L  
Side table:  
opaline white polyethylene structure (48)  
with internal light;  
transparent top (X\_81)

# matrioska

design\_Nicola Tonin

Elegante e raffinato, il tavolino Matrioska gioca su linee geometriche ed incontri di metallo color bronzo pietra, e varie essenze legno. La linea centrale in ferro svolge inoltre la funzione di divisorio, tra i due vani contenitori laterali.

Elegant and refined, MATRIOSKA coffee-table is based on geometric lines and marriages of stone bronze metal, and different wood species. The central, metal line serves as a divider between the two storage units.

Элегантный и изысканный журнальный столик MATRIOSKA демонстрирует геометрические линии и объединение камня, бронзы, металла и различных пород древесины. Центральная, металлическая линия служит разделителем между двумя блоками хранения.

6278

L 120 P 71 H 36 cm



Matrioska 6278

Coffee-table:  
stone bronze metal structure (83);  
heat-treated dark oak container (16)

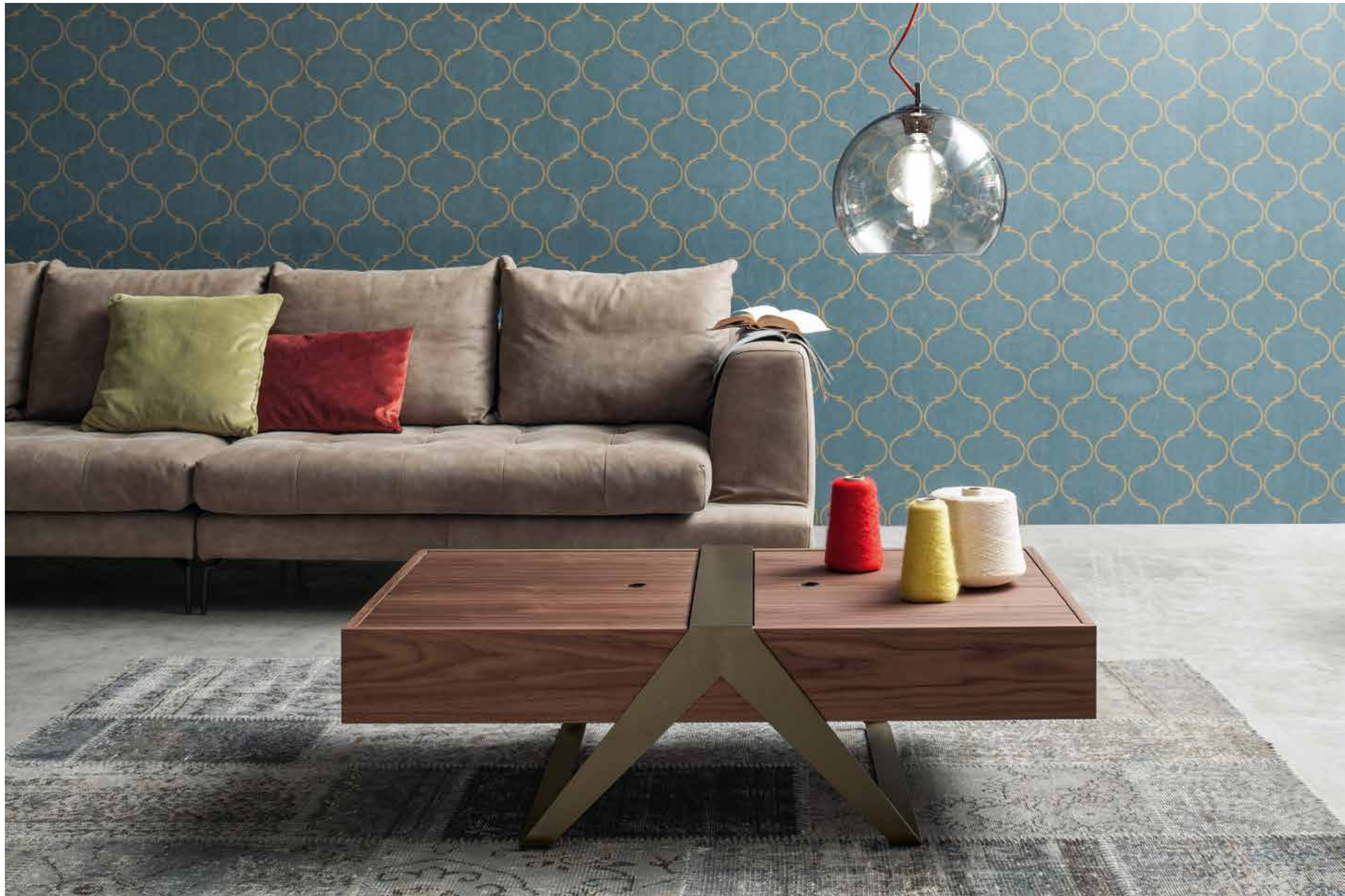

**Matrioska 6278**  
Coffee-table:  
stone bronze metal structure (83);  
Canaletto walnut container (14)

# narciso

design\_Davide Bozzini

Il metallo curvato prende per Narciso la forma di un petalo, che dolcemente si avvolge su se stesso. Un portaombrelli elegante e facilmente adattabile ad ogni contesto, anche soprattutto alla varietà di colori disponibili.

Curved metal takes the shape of a petal, with Narciso, softly twisting around on itself. An elegant, easily adaptable umbrella stand, perfect for every room, and available in tens of different colors.

Гнутый металл Narciso принимает форму лепестка, мягко изгибаясь вокруг. Элегантная, легко адаптируемая подставка для зонтов, идеально подходит для каждого помещения, а также доступна в десятках разных цветов.

7490

L 44 P 34 H 72 cm



Narciso 7490  
Umbrella stands:  
matt white (01) and matt beige (36)  
cast aluminum

**Narciso 7490**  
Umbrella stands:  
stone bronze (83) and Agata pink (68)  
cast aluminum



# pandora

design\_Nicola Tonin

Pandora esprime un lusso estremamente raffinato e curato in ogni minimo dettaglio. Pandora rappresenta l'unione di più elementi in un singolo prodotto. Inizia con una base in marmo, e sale in un variegarsi di elementi in legno massiccio, vetro in fusione, particolari in finitura oro, e splendidi piani in legno.

Pandora expresses an extremely refined and studied in great detail. Pandora represents the marriage of several different elements in one single product. It starts with a marble base, and goes up in a variety of components, made of solid wood, glass, gold and wonderful wooden tops.

Pandora выражает чрезвычайно изысканный и изученный в мельчайших подробностях характер. Pandora представляет собой объединение нескольких различных элементов в одном продукте. Начинается с мраморного основания и демонстрирует сверху различные компоненты, изготовленные из массива дерева, стекла и золота с прекрасными деревянными поверхностями.

6011

Ø 60 H 41 cm

6012

Ø 45 H 47 cm



**Pandora 6011- 6012**  
Coffee-table and Side table:  
glossy white Carrara marble base,  
solid natural oak, transparent glass,  
platinum and solid natural oak top (A)

Pandora 6011 - 6012  
Coffee-table and Side table:  
glossy Port Saint Laurent marble,  
solid Canaletto walnut, amber glass,  
gold, and solid Canaletto walnut top (C)

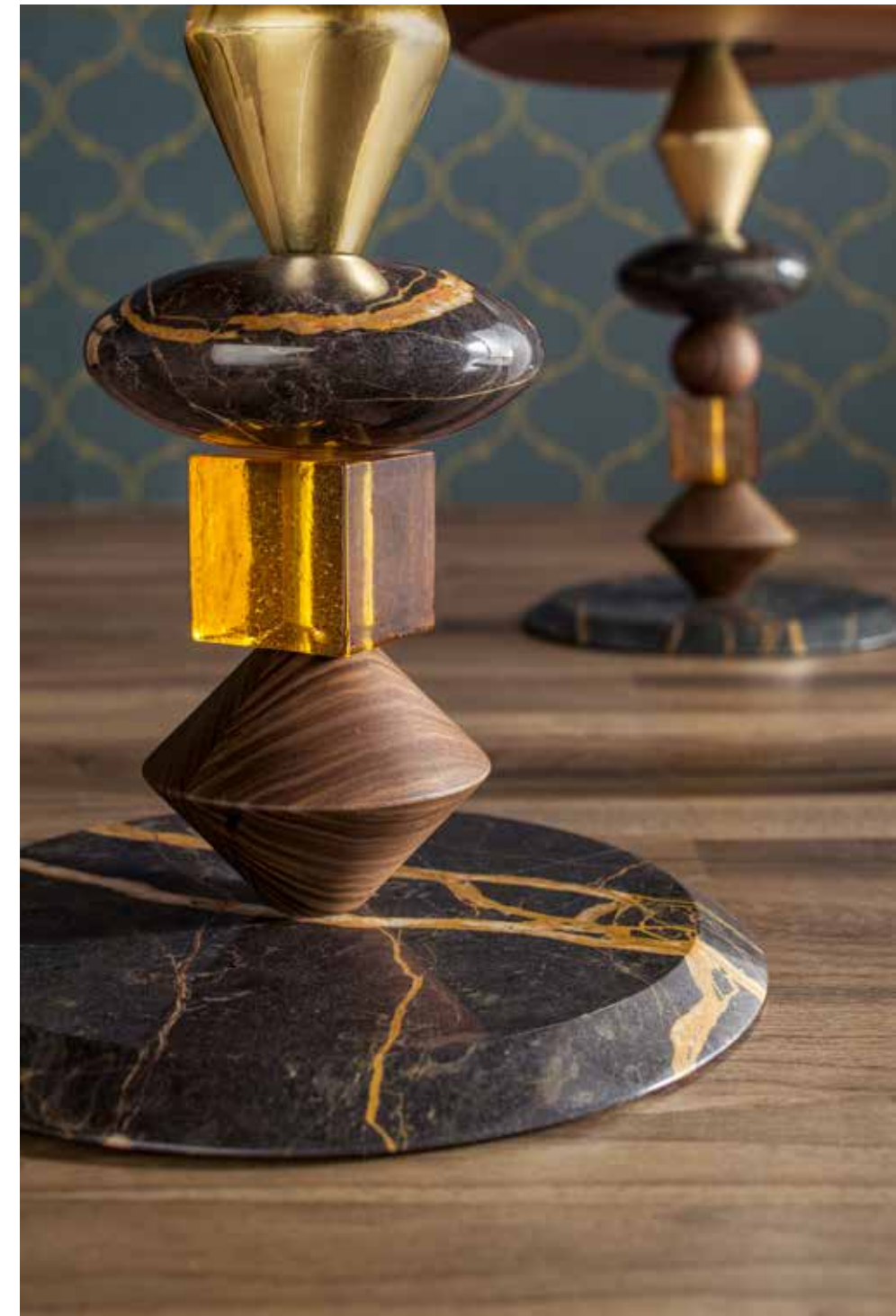
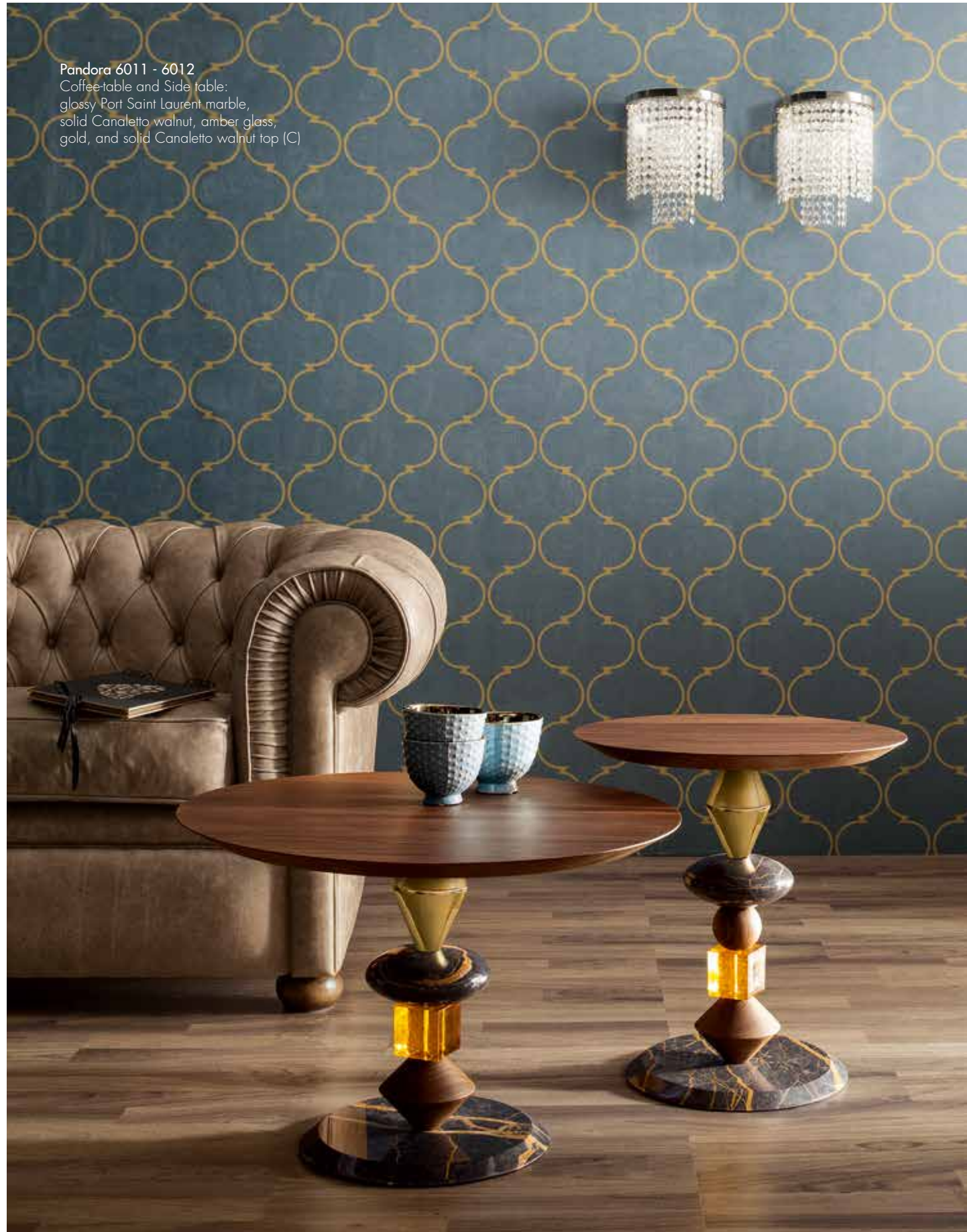



# parioli

design\_Studio28

Esteso in lunghezza, Parioli si concede lati corti smussati nel piano e perfettamente equilibrati nella base in metallo cromato. Il perfetto complemento per la zona living.

Parioli was given short, smooth sides, perfectly balanced with the chromed metal base. The perfect furniture for your living-room.

Parioli имеет короткие гладкие стороны, прекрасно сбалансированные основанием из хромированного металла. Идеальная мебель для вашей гостиной.

7315

L 160 P 60 H 30 cm  
(P) L 130 P 60 H 30 cm

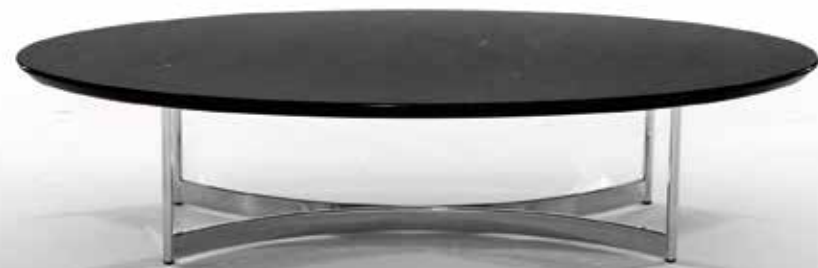

**Parioli 7315**  
Coffee-table:  
chromed metal structure (72);  
glossy white Carrara marble top (M\_101)

# pavones

design\_Nicola Tonin

Una linea zigzagante perfettamente marcata, snella ed elegante come il vetro di cui è composta. Una struttura semplice, fresca e scintillante, in metallo cromato. Un oggetto dalle possibilità incredibilmente variegate.

A zig-zagging, perfectly marked line, both thin and elegant, like the glass composing it. A simple, fresh and shiny structure, made of chromed metal. An object that gives ou plenty of options.

Зигзагообразная, идеально отмеченная линия — и тонкая, и элегантная, как стекло, образующее его. Простая, свежая и блестящая структура, выполненная из хромированного металла. Объект, который предоставляет множество вариантов.

8105

L 120 P 60 H 39 cm



Pavones 8105  
Coffee-table:  
chromed metal structure (72);  
extra-clear white curved glass top (V\_101)

# plissé

design\_Nicola Tonin

Plissé può offrire sia le funzioni di un tavolino con piano in vetro temperato, sia quelle di un comodo pouf contenitore. Disponibile in due versioni, si caratterizza per la plissettatura effettuata a mano su eco-pelle. La scelta di un tessuto ecologico si fa ancora più interessante grazie al vastissimo numero di colorazioni disponibili.

Plissé offers both the function of a coffee table – with a tempered glass top, and those of a comfortable pouf – with a storage unit. This piece is available in two versions, and is characterized by the hand-made pleating. We only use eco-leather, which makes Plissé even more interesting, since actually plenty of colors are available.

Plissé может стать как практичным столиком столика со стеклянной столешницей, так и удобным пуфиком с емкостью для хранения. В наличии две модели. Складки из искусственной кожи ручной работы. Выбор экологически чистого материала становится еще более предпочтительным благодаря широкому выбору доступных цветовых решений.

## 7335

(P) Ø 69 H 35 cm  
(A) Ø 84 H 36 cm  
(G) Ø 114 H 38 cm

## 7336

(P) Ø 69 H 30 cm  
(A) Ø 84 H 30 cm  
(G) Ø 114 H 30 cm



**Plissé 7335**  
Pouf with internal storage:  
blue (S\_34) and beige eco-leather (S\_36)



Plissé 7336  
Coffee-table:  
beige eco-leather (S\_36);  
extra-clear beige,  
tempered glass top (V\_136)



Plissé vive dei propri dettagli, si esprime osservandolo da vicino, vicinissimo, lì dove ogni piega è stata minuziosamente creata. Al centro di un ambiente, il vetro e la luce; per mantenere l'ordine, accomodarsi, creare un punto di appoggio elegante e pacato.

Plissé is all about its details: the best way to enjoy it, is to look extremely closely, there where each pleat was folded. Centrally, glass and light; an object to keep everything in order, or just to sit comfortably.

Plissé живет своими деталями, которыми можно наслаждаться, внимательно рассматривая каждую умело выделанную складку. Центральный элемент интерьера, стекло и свет. Блюститель порядка, залог комфорта, элегантная стабильная точка опоры.



# quiet

design\_Nicola Tonin

Ispirato ad uno stato di calma ed equilibrio, Quiet trova il suo fulcro nelle morbide linee del vetro del top. Curvature, queste, che si uniscono a quelle del legno curvato, la base perfetta per completarne la forma piacevolmente arcuata.

QUIET was inspired by a need for calm and balance, and it found its core in its top's soft lines. Such curves combine with the wooden one, and create a marriage of shapes that completes QUIET's smoothly arched shape.

QUIET был вдохновлен необходимостью спокойствия и равновесия, и он нашел свою сущность в мягких линиях его поверхности. Его изгибы сочетаются с изгибами деревянной поверхности и объединяют формы, завершающие плавную дугобразную форму QUIET.

8194

L 106 P 106 H 33 cm



**Quiet 8194**  
Curved MDF coffee-table;  
Canaletto walnut base (14);  
extra-clear transparent  
glass top (V\_100)



Quiet 8194  
Coffee-table:  
matt white lacquered curved MDF base (01)  
extra-clear transparent glass top (V\_100)



# raffaello

design\_Angelo Tomaiuolo

Raffaello rappresenta il risultato di una tecnica elaborata, che permette di creare una base in vetro curvato conica, solida e compatta. Due ripiani in legno, rovere scuro o noce canaletto, marcano la volontà di Tonin Casa di sperimentare sempre e comunque attraverso combinazioni di materiali ed effetti.

Raffaello is the result of an elaborate technique, that allows us to shape a curved glass base, and make it solid and compact. Two walnut, or dark oak shelves are the proof Tonin Casa is always looking for experimenting new styles through effects and materials' combinations.

Raffaello является результатом сложного технологического процесса, который позволяет создать основание из гнутого стекла конической формы, делая его прочным и компактным. Две деревянные полки из темного дуба или ореха словно напоминают о любви Tonin Casa к экспериментам через сочетание материалов и зрительных эффектов.

6208

L 92 P 88 H 35 cm



Raffaello 6208

Coffee-table:  
transparent curved glass structure (V\_81);  
Canaletto walnut shelf and top (14)





Si apre ampio e termina restringendosi, un cono di vetro su cui poggiare gli oggetti di ogni giorno, ma che possiede un'anima pratica, unita alla qualità estetica: l'apertura centrale infatti, oltre a valorizzare la curvatura e la linea del vetro, permette di raggiungere un comodo ripiano concepito come portariviste. Tutto visibile, in ogni dettaglio, per mostrare la qualità di ogni singolo pezzo.

It opens wide and it ends narrow, a glass cone on which to put every day's objects, but that still owns a strong practical soul: the central break, in fact, allows both to magnify the glass's curve, and to comfortably reach the magazine rack. Everything is visible, to show every single part's quality.

Столик расширяется кверху словно стеклянный конус, на котором можно располагать предметы повседневного обихода. Тем не менее душа у него практическая и не только эстетически прекрасная: открытое пространство в центре подчеркивает плавность линий и открывает доступ к нижней полке для журналов и газет. Все здесь на виду, чтобы подчеркнуть качество каждой детали.



# rea

design\_Nicola Tonin

Rea, disegnato prendendo ad esempio gli elementi naturali di un bosco, gioca su una serie di livelli, di diverse dimensioni, che si accostano l'uno all'altro, a formare un tutto unico e indivisibile. Un tavolino, o un servetto, i cui piani in legno catturano gli occhi quasi fossero in movimento.

REA, drawn after a wood's natural elements, plays on different levels, different dimensions that pair one with the other, composing a whole. A coffee-table, or a side-table, whose wooden tops capture your attention, as if they were moving.

REA, срисованный с натуральных элементов, играет на разных уровнях, в разных измерениях, что объединяет одно с другим, составляя единое целое. Кофейный или приставной столик, чьи деревянные поверхности привлекают ваше внимание из-за иллюзии движения.

6300

L 60 P 60 H 46 cm

6303

L 88 P 88 H 34 cm



Rea 6300 - 6303  
Multi-layered Coffee-table and Side-table.  
Canaletto walnut covering (14)

# rimini

design\_Angelo Tomaiuolo

Un servetto in grado di colpire e stupire tanto quanto un ampio tavolo: Rimini spicca dovunque grazie al particolare design della struttura in metallo, alla ricchezza della base in marmo italiano, ed al piano superiore in vetro verniciato e acidato. Tre diversi materiali su di un unico pezzo, da combinare in moltissime varianti: metallo bianco, nero o bronzo; marmo bianco di Carrara, nero Marquinia e bronzo Emperador; vetro fumé trasparente, acidato nero, bianco o beige.

A coffee table, capable of moving and amaze just like a dining table: Rimini stands out everywhere, thanks to its metal structure's peculiar design, to its base's Italian marble richness, and to the varnished and acid-etched glass top. Three different materials on just one object offer you a huge range of combinations: white, black or bronze metal; white Carrara, black Marquinio, Emperador bronze marbles; transparent grey, black, white and beige acid-etched glass.

Низкий столик, который способен удивить не меньше чем классический просторный стол: Rimini выделится в любом месте благодаря особенному дизайну металлической структуры, богатству мраморного основания и столешнице из травленого окрашенного стекла. Три различных материала в одном. Множество сочетаний: металл белого, черного или бронзового цвета, белый мрамор Каррары, черный мрамор Маркина или бронзовый Эмперадор, прозрачное дымчатое, травленое черное, белое или бежевое стекло.

6232

Ø 84 H 39 cm

6233

Ø 39 H 50 cm



**Rimini 6233**  
Side tables:  
matt black (02) and matt white metal structure (01);  
Marquinia glossy black marble (M\_102)  
and Carrara glossy white marble (M\_101);  
transparent fumé glass tops (V\_85)





**Rimini 6232**  
Coffee-table:  
Stone bronze structure (83);  
Emperador glossy bronze marble  
(M\_183);  
frosted beige glass top (V\_636)

Abbinare tutti questi materiali è stata una piacevole sfida: marmo nero e bronzo pietra, perfettamente uniti, si illuminano con la luce che filtra attraverso il vetro fumé. Giocare con tanta bellezza, sapendo di poter contare su di un materiale di pregio e su lavorazioni accurate: un'arte tutta italiana che Tonin Casa tenta sempre di rispettare al meglio.

Matching all these different materials was a pleasing challenge: black marble and stone bronze, perfectly combined, shine with the light filtering through the transparent grey glass. To be able to play with such beauty, knowing that you can also rely on precious materials and an accurate manufacture: a completely Italian art Tonin Casa is always doing its best to respect.

Мы с готовностью приняли вызов объединить все материалы: черный мрамор и бронзу "натуральный камень", которые освещает нежный свет, льющийся сквозь дымчатое стекло. Играть с такой красотой, зная, что можно полностью положиться на качество материалов и умелые руки: истинное итальянское мастерство, которому всегда соответствуют творения Tonin Casa.



# space

design\_Diego Barbieri

Due piani che si muovono come anelli attorno ad un'orbita, ad altezze diverse e leggermente spaiati, per creare un effetto di movimento e leggerezza. A sorreggerli, una struttura in metallo verniciato, semplice ed elegante.

Two tops move like rings around an orbit, slightly mismatched, to create movement and lightness. To hold them, a painted metal structure, simple and elegant.

Две поверхности передвигаются как кольца вокруг орбиты, слегка несочетающиеся, чтобы создать движение и легкость. Для их фиксирования служит окрашенная металлическая конструкция — простая и элегантная.

6296

L 40 P 52 H 55 cm

6297

L 110 P 85 H 33 cm



Space 6296 - 6297  
Coffee-table - Side-table.  
Bicolor-version: 2 matt black lacquered tops (02) &  
1 Canaletto walnut top (14);  
Monocolor-version: 3 matt white lacquered tops (01)

Space 6297  
Coffee-table:  
monochrome version,  
3 lacquered matt white tops (01)



# spiga

design\_Angelo Tomaiuolo

Spiga è un perfetto ed estremo esperimento di design: la naturalezza della spiga di grano incontra la raffinata lavorazione di un materiale plastico. Linee morbide si creano per raggiungere una linea delicata e sviluppata verso l'alto, dove si snodano i petali appendiabiti. Un'ulteriore livello di complessità viene dato dalla luce interna, presente in una delle moltissime versioni disponibili.

Spiga is a perfect and extreme design experiment: the naturalness of an ear of corn meets the refined manufacture of a plastic material. Soft lines were created to reach a delicate line, ending up with the coathanger petals. A further level of complexity was given by the version with the internal light.

Spiga является идеальным и экстремальным экспериментом с дизайном: естественность початка кукурузы сочетается с изысканным производством пластикового материала. Мягкие линии были созданы для получения изысканной линии, заканчивающейся лепестками вешалки для пальто. Дальнейший уровень сложности был создан в версии с внутренним освещением.

## 7415

(P) Ø 35 H 172 cm  
(G) Ø 35 H 186 cm

## 7415L

(P) Ø 35 H 172 cm Q  
(G) Ø 35 H 186 cm Q



Spiga 7415  
Free-standing Coathanger:  
polyethylene structure, dove grey (60)  
and bronze, Corten effect (54)



Spiga 7415 - 7415L  
Free-standing Coathanger:  
polyethylene, opaline white (48)  
with internal light, and matt red (03)



# tree

design\_Diego Barbieri

Come nella stilizzazione di un albero, le linee della base di Tree si accostano geometriche le une alle altre, e terminano d'un tratto nell'orizzontalità del piano. Metallo e legno si fondono per creare separazione e levità.

Similarly to a simplified arboreal shape, TREE's lines pair geometrically, and suddenly end with the top's horizontality. Metal and wood melt to create separation and lightness.

Аналогично упрощенной форме дерева, линии TREE геометрически соединяются и внезапно оканчиваются верхним горизонтальным положением поверхности. Металл и дерево незаметно переходят друг в друга, создавая разделение и легкость.

6298

Ø 85 H 32 cm

6299

Ø 40 H 56 cm



Tree 6298 - 6299  
Coffee table and Side table.  
matt white varnished metal structure (01);  
natural oak covered top (17)



Tree 6298 - 6299  
Coffee-table and Side table:  
black metal structure (02);  
Canaletto walnut top (14)

# tudor

design\_Studio28

Un tavolino, Tudor, che si lascia ispirare dalla forza e dalla preziosità della famiglia da cui prende il nome. Come una grande dinastia, possiede una base forte ed elegante, e culmina in un perfetto sostegno, il piano in vetro curvato.

TUDOR, a coffee-table that was inspired by the strength and the preciousness of the family after which it takes its name. Just like a great dynasty, it owns a strong and elegant base, and ends in a perfect support: the curved metal top.

TUDOR, журнальный столик, который был вдохновлен силой и ценностью семьи, чье имя он позаимствовал. Так же, как и великая династия, он обладает сильным и прекрасным основанием, завершаясь идеальной поддержкой: поверхностью из гнутого металла.

6630

(EFCV) L 117 P 78 H 34 cm  
(CSV) L 120 P 65 H 36 cm



Tudor 6630  
Coffee table:  
glossy mud cultured marble base (551);  
elliptical transparent glass top (V\_81)



# truly

design\_Studio Tonin Creatives

I pouf Truly disegnati da Studio Tonin Creatives sono ormai un must della collezione: il design squadrato e l'imbottitura in perle di polistirene espanso li rendono sia comodi che funzionali. Realizzati in due diverse dimensioni, vengono da sempre rivestiti con eco-pelle. Oggi, tuttavia, due nuovi tessuti si rendono disponibili: gessato e pied-de-poule.

Studio Tonin Creatives designed these poufs, which, at this point are a must-have piece in our collection: the square design and the padding made of expanded polystyrene pearls, make them both comfortable and functional. There are two different sizes, both covered in eco-leather. Starting from this year, another two new fabrics are available: a pinstriped fabric, and a pied-de-poule.

Пуфы Truly от Studio Tonin Creatives превратились в обязательный атрибут коллекции: квадратная форма и набивка из пенополистирола делают их одновременно практичными и удобными. В наличии модели двух размеров с обивкой из искусственной кожи. На сегодняшний день коллекция обогатилась новыми моделями с тканевой обивкой: в полоску и гусиную лапку.

**7300**

L 50 P 50 H 40 cm

**7301**

L 70 P 70 H 40 cm



Truly 7300 - 7301

Poufs:

brick red pinstripe fabric (GT\_03);

brick red pied-de-poule fabric (TP\_03)

Due nuovi tessuti per creare il fascino dell'alta moda, innovativo, bello, raffinato: Truly si copre di un nuovo abito, le cui texture e qualità avvolgono perfettamente le sue forme disegnate ad arte. Un classico che ritorna ad essere nuovo, grazie all'impegno nella ricerca di materiali di alto profilo.

Two new fabrics, to provide a high fashion charme, beautiful, innovative, refined: Truly wears a dress, whose textures and qualities perfectly envelop its art-inspired shapes. A classic piece, renewed by our research of high quality materials.

Ткани двух новых расцветок придают шарм высокой моды: модный, красивый, изысканный. Пуф Truly представлен в новом амплуа с качественной текстурой, идеально сочетающейся с умело выверенными формами. Классический предмет интерьера в новом образе, который стал результатом поиска качественных элитных материалов.



# velo

design\_Angelo Tomaiuolo

L'idea dietro a Velo, è quella di riuscire a creare un oggetto sia resistente, che leggero ed elegante: un'unica linea di vetro curvato, lavorata per fornire sia una base di appoggio, che uno spazio contenitore. Un velo, leggero e delicato; essenziale.

The idea behind Velo, is to create an object both resistant and elegant: a single, curved glass line, shaped to be a supporting base and a storage unit. A veil, light and delicate; essential.

Идея Velo состоит в том, чтобы создать качественный и в то же время элегантный объект: цельная, гнутая полоса стекла, которой придали форму для того, чтобы быть опорным основанием и блоком для хранения. Завеса, легкая и изысканная; незаменимая.

8166

L 95 P 76 H 33 cm



Velo 8166  
Coffee-table:  
extra-clear transparent curved glass (V\_100)

# volup

design\_Davide Bozzini

Una linea avviluppata su se stessa, disposta orizzontalmente per creare sia un appoggio che un vano contenitore. Il vetro curvato funge sia da struttura che da ripiano, e può colorarsi nelle varianti in fumé trasparente ed extra-chiaro trasparente.

A line twirling on itself, disposed horizontally to create both support and storage. The curved glass works both as a structure and as a top, in its fumé transparent and extra-clear transparent finishes.

Линия, вращающаяся вокруг своей оси, расположенная горизонтально, чтобы создать как поддержку, так и место для хранения. Гнутое стекло работает как структура и как вершина, покрытая ее дымчатым прозрачным и очень четким прозрачным покрытием.

8195

L 84 P 88 H 36 cm



Volup 8195  
Coffee-table:  
transparent fumé curved glass (V\_85)





# wood

design\_Plurimo Design

Wood è due oggetti in uno: un appendiabiti e una consolle in un solo elemento; un oggetto che si sviluppa in orizzontale, nel piano in legno tinto, ed anche in verticale, nelle aste appendiabiti in legno. Vario, leggero e resistente come una foresta di bambù: una forma completamente nuova, esteticamente affascinante.

WOOD is two objects in one: a coathanger and a console table; an object with an horizontal dimension - the painted wood shelf - and a vertical dimension - the coathanger poles. Vary, light and resistant, just like a bamboo forest: a completely new, fascinating shape.

WOOD — это два объекта в одном: вешалка для верхней одежды и консольный стол; объект с горизонтальной плоскостью — окрашенной деревянной полкой, и вертикальной плоскостью — стойками вешалки. Разноплановый, легкий и устойчивый, этот предмет мебели напоминает бамбуковый лес: совершенно новая, увлекательная форма.

7419

L 108 P 43 H 170 cm



## Wood 7419

Coathanger:

poles: Canaletto walnut finishing (14);  
shelf: Agata pink laquered (68)



# arpa

design\_Angelo Tomaiuolo

Lo stile del tavolo Arpa, gli intrecci della base in legno curvato e la piacevole rotondità del piano sono se possibile ancor più evidenti in questa sua versione a consolle. I classici colori del legno di Tonin Casa – noce canaletto, rovere scuro termotrattato e bianco opaco – incontrano piani in vetro nero, o bianco extra chiaro; le versioni in marmo comprendono il bianco di Carrara lucido, il Marquinia lucido ed il marmo grigio lucido.

Arpa's curved wood base and its round top's style are possibly even more evident in this console version. Tonin Casa's wood's classic colors – Canaletto walnut, dark heat-treated oak and matt white – meet black, or extra-white glass tops; there also are marble versions, with either glossy white Carrara marble, glossy black Marquinia marble and glossy grey marble.

Основание Агра из гнутого дерева и стиль его круглой поверхности, возможно, еще более заметны в этой консольной версии. Классические цвета древесины Tonin Casa — грецкий орех Каналетто, темный термообработанный дуб и матовый белый — соответствуют экстра-белым стеклянным поверхностям; также есть мраморные версии, либо с глянцевым белым мрамором Каррара, либо с глянцевым черным мрамором Маркиния.

6470

L 116 P 46 H 77 cm



Arpa 6470  
Console table:  
Canaletto walnut base (14);  
glossy bronze Emperador  
marble top (M\_183)

Marmo e legno qui si incontrano e rendono un articolo da presentarsi immediatamente, all'arrivo a casa, una sorta di preambolo che catturi l'attenzione e dimostri il proprio stile. Concedetevi di avvicinarvi il più possibile, di osservare come le venature del marmo contrastino l'uniforme colorazione del legno: Arpa dimostrerà abilmente la perfezione di ogni sua rifinitura.

Marble and wood here meet, and make what could be an object only meant to immediately greet visitors, some kind of a beforehand presentation of your home's style. Let yourselves get as close as possible, observe how marble streaks contrast wood's perfect coloring: Arpa will cleverly show its every finishing's perfection.

Мрамор и дерево делают так, что сразу же при входе в дом консоль становится преамбулой, привлекающей внимание своим собственным стилем. Подойдите к ней ближе и рассмотрите рисунок мрамора, контрастирующего прожилки дерева: Арпа – это безукоризненность каждого элемента отделки.



# albatros

design\_Plurimo Design

Due ali di metallo curvato si incontrano in un inserto in legno, creando un disegno che decora il muro cui si appoggia. Consolle e mensola Albatross si prestano a diversi ambienti, grazie alla gamma di colorazioni disponibili. Finiture in bronzo pietra, verniciato bianco, rosa cipria e grigio caldo riescono a concedere un'immagine sempre diversa a ciascun complemento.

Two curved metal wings meet in a wood joint, creating a decoration for the wall against which they stand. Albatross console table and shelf are perfect for different interiors, thanks to the range of colors available. Stone bronze, white varnished, pink powder and warm grey finishes manage to make every piece look extremely different from the other.

Два изогнутых металлических крыла встречаются в древесине, создавая рисунок, украшающий стену. Консоль и полка Albatross идеально подойдут для любого интерьера благодаря выбору цветовой отделки. Бронза "натуральный камень", белая эмаль, розовая пудра и серый придадут каждому элементу новый штрих и эффект.

6440

L 120 P 25 H 25 cm

6441

L 70 P 20 H 13 cm



Albatros 6441

Shelves:  
matt white (01)  
and matt black (02) metal structure;  
central element covered  
in natural oak (17)





**Albatros 6440**  
Console table:  
stone bronze metal structure (83);  
central element covered in  
Canaletto walnut (14)

Alle volte, concentrarsi sull'effetto finale, sul totale di un'immagine, rende possibile coglierne i dettagli: preoccuparsi di sfalsare il metallo piegato, curare il tipo di legno dell'insero, provvedere ad analizzare le ultime tendenze in fatto di colorazioni. Lavorare sul totale per poter mostrare ogni particolarità.

It is sometimes possible to catch the details by focusing on the final effect, on the resulting image: worrying about staggering two precious metal bars, caring about what kind of wood you should use, prepare an analysis of the last trends in fashion. Working on the entirety, in order to show every bit.

Иногда отдалиться во власть конечного результата, общего эффекта позволяет поймать детали, увидеть смещение гнутого металла, уход за деревом вставки, анализировать последние тенденции в мире цвета. Работая над общей целью, показать каждую деталь.



# altamura

design\_Studio Tonin Creatives

La consolle Altamura si ispira alla leggerezza del vetro, messa in mostra ed esaltata dal minimalismo delle forme. Una lavorazione complessa come quella della curvatura del vetro porta alla creazione di un oggetto lieve, elegante e raffinato. A dare spessore e varietà alla consolle, pensa un ripiano, disponibile sia in vetro temperato, che in legno.

Altamura console table takes its inspiration from glass' lightness, and tries to glorify it with its shapes' minimalism. The complex manufacture of curved glass, leads to a light, elegant and refined object. The wooden, or tempered glass shelf, was thought to thicken and vary the console table.

Консольные столы Altamura берут свое вдохновение от легкости стекла и пытаются превознести минимализм с помощью его форм. Комплексное производство гнутого стекла обеспечивает легкий, элегантный и утонченный объект. Полки из дерева или закаленного стекла предполагались для уплотнения и видоизменения консольного стола.

6460R

L 112 P 35 H 75 cm



Altamura 6460R  
Console table:  
extra-clear transparent curved glass structure (V\_100);  
Canaletto walnut shelf (14)



# sunset

design\_Nicola Tonin

Proprio come il tramonto, il cerchio perfetto formato dalla specchiera Sunset si sposta verso destra, creando un pittoresco effetto di sbilanciamento. Lo specchio è disponibile nella versione argentata e in quella bronzata, in modo da adattarsi a diversi contesti luminosi. La mensola in legno noce canaletto, o rovere scuro termotrattato taglia il "sole" a tre quarti, proprio come farebbe la linea dell'orizzonte.

Just like the sunset, the perfectly shaped circle formed by Sunset mirror moves right, creating a picturesquely unbalanced effect. The mirror is available in the silver version and in the bronze one, so to adapt to different lights. The Canaletto walnut, or dark heat-treated oak shelf "cuts" the sun just like the edge of the horizon would.

Так же, как закат, идеально сформированный круг, образованный зеркалом Sunset, перемещается вправо, создавая живописно несбалансированный эффект. Зеркало доступно в серебряной и бронзовой версии, чтобы адаптироваться к различному освещению. Полки из грецкого ореха Каналетто или темного термообработанного дуба «разрезают» солнце так же, как это делает край горизонта.

7501

L 120/160 P 36 H 120 cm

Sunset 7501  
Console table/Mirror:  
silver mirror (V\_45);  
heat-treated dark oak shelf (16)



Sunset 7501  
Console table/Mirror:  
silver mirror (V\_45);  
Canaletto walnut shelf (14);  
touch LED light



# tiffany

design\_Angelo Tomaiuolo

Tiffany è una consolle ispirata ad un lusso morbido e delicato: il legno di frassino, in finitura noce Canaletto, rovere scuro, o rovere naturale, si abbina lieve al rivestimento in pelle ed eco-pelle, in tutte le colorazioni disponibili. Trapuntata e rivestita come il migliore degli imbottiti Made in Italy, Tiffany riesce a combinare due mondi tecnicamente diversi, unendoli in un prodotto dalla grazia unica.

Tiffany console table; it got its inspiration by a soft and delicate luxury: the ash tree - with a Canaletto walnut, dark oak, or natural oak finishing - quietly marries the leather, or eco-leather covering. A quilted covering, representation of the best Made in Italy manufacture, covers Tiffany, and combines two technically different worlds, resulting in a uniquely gracious product.

Консольный стол Tiffany; он получил свое вдохновение от мягкой и нежной роскоши: ясень с отделкой из грецкого ореха Каналетто, темного дуба или натурального дуба — легко объединяется с покрытием из кожи или эко-кожи. Стеганое покрытие — пример лучшего производства «Сделано в Италии», охватывает Tiffany, и сочетает в себе два технически разных мира, создавая уникально милый продукт.

6436

L 136 P 40 H 74 cm



Tiffany 6436  
Ash wood structure: painted dark oak (16);  
covering: powder grain leather (PF\_47) with rhombus pattern



# alicante

design\_Claudio Lovadina

Con Alicante, il designer Lovadina ha deciso di unire le funzioni di oggetti diversi in un'unica opera di design. Una specchiera squadrata di solo vetro diviene ora anche un comodo appendiabiti, o si dota di un cassetto da utilizzare nei modi più svariati. L'aumentare delle funzioni va di pari passo con l'aumentare dell'effetto estetico: un sistema di illuminazione touch a led illumina Alicante, che diviene così anche una lampada a muro. Questa particolare specchiera si presenta con uno specchio argentato, uno specchio bronzato, e appendiabiti e cassette in noce canaletto o rovere scuro termotrattato.

## 7504C

L 71 P 2,5/20 H 180 cm

## 7504A

L 71 P 2,5/20 H 180 cm

In Alicante, designer Lovadina decided to reunite different objects' functions in just one piece of design. A square, full glass mirror now becomes a useful coat hanger, or is equipped with an extremely adaptable drawer. The more the functions are, the better the aesthetic: a LED lighting system with touch control makes Alicante shine, and turns it into an elegant wall lamp. This peculiar mirror is provided with a silvered, or a bronzed mirror, and Canaletto walnut, or dark heat-treated oak drawers.

В Alicante дизайнер Ловадина сочетает назначения разных предметов в едином дизайнерском произведении. Квадратное зеркало без рамы становится удобной вешалкой или оснащается выдвижным ящиком. Расширение функций идет в ногу с усилением эстетической привлекательности: сенсорное освещение превращает Alicante в настенную лампу. Это необычное зеркало может иметь отделку серебром, бронзой, оснащаться вешалкой и ящиками из черного ореха или термообработанного темного дуба.



Alicante 7504C - 7504A

Mirrors:

silver mirror (V\_45);

drawer/hangers: solid wood, Canaletto walnut finishing (14)

# callas

design\_Studio Archirivolto

Soliti ad associare il legno curvato a forme ampie e voluttuose, Callas ci stupisce per l'uso anti-conformista: le curve sono qui rapide e decise, e formano la cornice entro la quale osservare il proprio riflesso. Un'ulteriore spinta verso l'innovazione viene data dalla versione in vetro fumé trasparente, unica nella sua eleganza.

We are used to think of curved wood as a voluptuous and wide-shaped element, but CALLAS comes as a surprise: curves are here fast and neat, a frame holding your reflection. To further push towards innovation, a transparent fumé version is available, a uniquely elegant option.

Мы привыкли думать о гнущем стекле как об объемном и широком пластинчатом элементе, но CALLAS — настоящий сюрприз: его кривые линии — аккуратные и опрятные, рама удерживает ваше отражение. Толчком к дальнейшим инновациям стала прозрачная дымчатая версия — эксклюзивный элегантный вариант.

7528

(Q) L 110 P 6 H 110 cm  
(R) L 108 P 6 H 200 cm



Callas 7528R  
Mirrors:  
extra-clear transparent curved glass (V\_100);  
silver glass mirror (V\_45)

# costantia

design\_Studio28

Elegante e raffinato, Costantia è uno specchio che si esprime nella semplicità delle forme e nella qualità della lavorazione. Un unico vezzo lo caratterizza: il bisello perfettamente smussato, a concedere ulteriore grazia e un minimo movimento alla solidità della struttura.

Elegant and refined, Costantia is a mirror expressing simplicity of shapes, and quality in manufacturing. One tiny, characterizing exception: the perfectly smooth glass frame, to enhance this mirror's grace, and to add movement to the structure's solidity.

Элегантное и изысканное, Costantia — зеркало, выражающее простоту форм и качество в производстве. Одно маленькое характерное исключение: идеально гладкая рама из стекла, которая усиливает шарм этого зеркала и добавляет движение к монолитности структуры.

## 7519

(SR) L 106 H 200 cm  
(SQ) L 130 H 130 cm  
(SQP) L 106 H 106 cm

Costantia 7519SR  
Bevelled mirrors:  
silver mirror (V\_45)



# imperia

design\_Claudio Lovadina

Specchio definito tecnicamente "inclinato", Imperia è decisamente molto di più: la sua struttura particolare ottiene il duplice effetto di moltiplicare l'immagine riflessa e di ampliare la stanza in cui viene appeso lo specchio. È disponibile nella sola versione argentata proprio per esaltare la tridimensionalità della forma, oltre alla rifrazione della luce.

This mirror is technically referred to as "skewed", but it definitely is much more than this: its peculiar structure can actually duplicate the images reflected on it, and hence magnify the room in which it is hung. Only the silver mirror version is available, precisely to enhance its tridimensional shape, and to better refract light.

С технической точки зрения это наклонное зеркало. Но Imperia – это намного больше: его особенная структура обладает двойной функцией умножения отражения и визуального расширения пространства. В наличии модель с серебряной отделкой, которая подчеркивает трехмерность формы и отлично преломляет свет.

7527

L 90 P 11 H 78 cm

Imperia 7527

Mirrors:  
silver mirror (V\_45)





# marguerite

design\_Nicola Tonin

Un taglio particolare ed una forma unica che si spezza per dare spazio, oltre allo specchio, anche alla fantasia della struttura. Il legno ne risulta esaltato ed arricchito ad un tempo, e l'accoppiata con specchi argentati o bronzati rende Marguerite un pezzo unico.

A peculiar cut and a unique shape, breaking to add a new space - other than the mirror - to the structure's pattern. Wood comes out enriched, and its marriage with bronzed, or silver mirrors, makes Marguerite a one-of-a-kind piece.

Своеобразный крой и уникальная форма расширяют границы, добавляя, помимо зеркала, новое пространство в рисунок структуры. Обогащенное дерево в тандеме с бронзовыми или серебряными зеркалами превращает Marguerite в эксклюзивную работу.

6465

(P) L 40 H 80 cm  
(A) L 80 H 80 cm  
(G) L 50 H 160 cm

Marguerite 6465

Mirrors:  
natural oak structure (13);  
bronzed mirror (V\_184)



Marguerite 6465  
Mirrors:  
Canaletto walnut  
structure (14);  
bronzed mirror  
(V\_184)

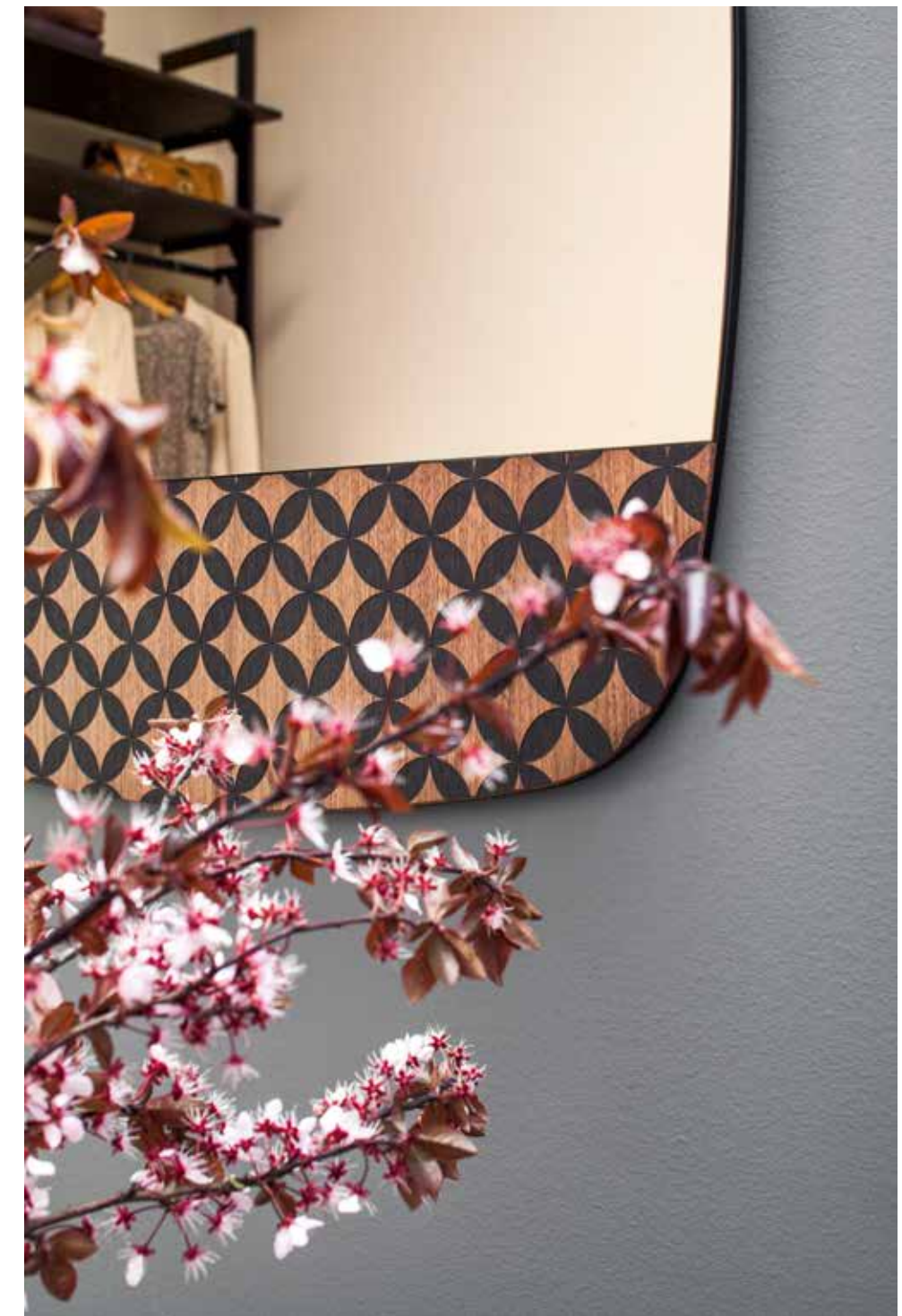

# olmi

design\_Nicola Tonin

La specchiera Olmi ricorda una coppia di ellissi, lievemente allargate verso il basso, che siano uscite l'una dall'altra. La prima, la base, serigrafata o bronzata in varie finiture, lascia spazio al suo interno allo specchio vero e proprio, anch'esso bronzato o argentato.

Olmi mirror reminds of a double ellipsis, slightly stretched at the bottom, one coming out of the other. The first one - the base with serigraphy - leaves room to the actual mirror.

Зеркало Olmi напоминает двойной эллипсис, слегка растянутые книзу, в котром один выходит из другого. Первый из них - основа с шелкографией - вмещает в себе настоящее зеркала.

7507

L 55/45 H 180/153 cm

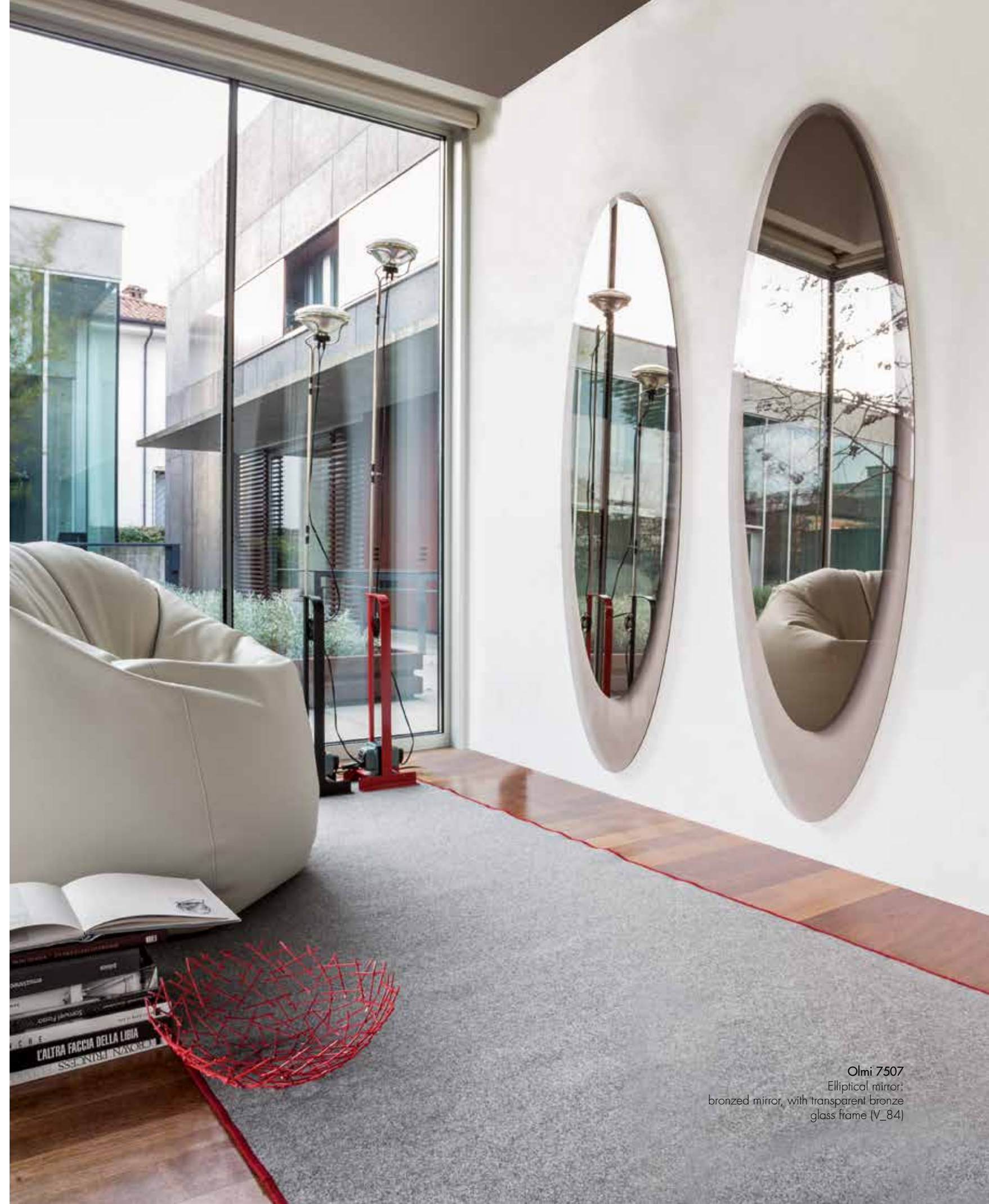

Olmi 7507  
Elliptical mirror:  
bronzed mirror, with transparent bronze  
glass frame (V\_84)

# kolonaki

design\_Studio28

Kolonaki è un'ellissi obliqua, poggata su di una base leggera e dal fascino contemporaneo, che può essere rivestita con le nostre migliori pelli ed eco-pelli. Uno specchio per far valere l'estro creativo di ogni stanza.

Kolonaki is an oblique ellipsis, standing on a light and contemporary looking base. It can be covered in our best leathers and eco-leathers. A mirror worth your room's creativity.

Kolonaki — наклонный эллипс, стоящий на светлой и современно выглядящей основе. Ее можно декорировать нашими покрытиями из лучших видов кожи и эко-кожи. Зеркало, которое достойно отобразит оригинальность вашей комнаты.

7526

Ø 31 H 170 cm

**Kolonaki 7526**  
Mirrors:  
covered in blue (S\_34)  
and aubergine purple (S\_77)  
eco-leather



# skin

design\_Nicola Tonin

Skin nasce per fare parte di un tutto che si allarghi sulle pareti: nasce perché uno specchio si unisca ad un altro, e quindi ad un terzo e così via, per creare percorsi di luce dalle potenzialità illimitate.

SKIN was born to be part of a whole, spreading through your walls. A mirror goes close, next to the other, composing, possibly unlimited light patterns.

SKIN был рожден для того, чтобы стать частью целого, распространяясь через стены. Одно зеркало расположено вблизи от другого, образуя неограниченное количество световых эффектов.

7530

L 54 P 3 H 34 cm

Skin 7530  
Mirror:  
bronze mirror (V\_184)



# stone

design\_Angelo Tomaiuolo

Il design di Stone ricorda precisamente quello di una pietra vista da un punto di zenit perfetto: come un triangolo che abbia angoli estremamente smussati, Stone sembra chiamare a sé una dimensione ulteriore, quella del riflesso che vuole portare all'interno delle vostre stanze.

STONE's design reminds precisely that of a rock as seen from above, at zenith: just like a triangle with smooth angles, STONE clearly refers to another dimension - that of the reflection, willing to bring life into your rooms.

Дизайн STONE напоминает скалу, которую видно выше, в зените: так же, как треугольник с гладкими углами, STONE явно относится к другому измерению - оно вдыхет жизнь в ваши комнаты своим отражением.

## 7529

(P) L 66 P 3 H 83 cm  
(A) L 90 P 3 H 114 cm  
(G) L 121 P 3 H 152 cm

Stone 7529  
Mirror:  
silver mirror (V\_45)



# toshima

design\_Studio Tonin Creatives

Una serigrafia a cornice, netta, geometrica e precisa, a coronare la semplice modernità della specchiera Toshima. Le finiture degli specchi, e le variazioni delle serigrafie, per concedere ad un minimalismo estremo, di cedere alle lusinghe di ogni preferenza.

**5030**

L 64 H 168 cm

**5032**

L 80 H 80 cm

A serigraphy on a frame, geometric and precise, to crown Toshima mirror's simple modernity. The mirrors' finishes, the variations of the serigraphies, allow to create an extreme minimalism, in every room.

Шелкография на раме, геометрическая и точная, довершающая простую современность зеркала Toshima. Отделка зеркал в вариациях шелкографии позволяет создать абсолютный минимализм в каждой комнате.

**Toshima 5032**  
Square mirror:  
extra-clear white frame;  
silver glass (V\_101)







Atomo 9102S  
Hanging Lamp:  
blown glass, with anthracite grey cable.  
Set A (transparent fumé glass,  
transparent glass, copper)



Rain 9100  
Hanging lamp:  
blown glass.  
Finishes: transparent fumé glass,  
transparent glass, amber.



### i colori e la pioggia the colors and the rain

---

Modellando il vetro, e allungandolo, la sensazione di gravità spinge a percepire con maggiore nitidezza le variazioni di colore. Come una pioggia leggera che cangi i punti di luce, il vetro si modifica, ruota al centro della stanza e produce effetti limpidi ed intimi. Cambiano i colori, per attivare i sensi in maniera antica e contemporanea, per colorare con toni pastello oppure con chiare luci soffuse. Un punto luce, con Rain, diventa naturalmente il focus dell'intera stanza, donando ulteriore importanza ad ogni dettaglio del proprio living.

---

By shaping glass, and stretching it, the sensation of gravity being present pushes your perception. Color variations are hence more clear. Just like a light rain falling, glass changes, it spins at the middle of the room and produces clear and intimate effects. The colors change to activate your senses in an ancient and contemporary way, to paint pastel and clear and soft lights. Only one light gets the focus of the entire room, enhancing the importance of your furniture's every detail.



questione di punti di vista  
a matter of perspectives

---

Guardi un oggetto e pensi: "è il mio". Lo metti in una stanza, in un contesto, e pensi: "è perfetto". Tonin Casa crea un design pensando ad ogni suo angolo, guardandolo da ogni direzione. Da tutte le prospettive; dal tuo punto di vista.

---

You look at an object, and think: "That's it". You put it in a room, in an environment, and think: "That's perfect". Tonin Casa's design thinks from every point of view, looking at that object from every direction. Every perspective; your point of view.

Ago & Filo 9105 00SP  
Hanging lamp:  
white lamp shade;  
red cable



### variazioni di linee diverse lines

---

Si tratta di curve, gentili e delicate, e pure presenti, visibili e di impatto. Creare un pezzo di design significa anche combinare colori e forme, in modo da giungere a combinazioni che sappiano fondere innovazione e unicità.

---

It's all about lines, gentle and delicate, yet present, visible and strong. To create a piece of design means also to combine shapes and colors, and to produce combinations that can marry innovation and uniqueness.



Santena 95004 01  
Hanging lamp:  
chrome/Asfour crystal, oval structure

Santena 95004 02  
Wall lamp:  
chrome/Asfour crystal structure



Santena 95004 03  
Table lamp:  
chrome/Asfour crystal structure



Rivalto 95002 01/02  
Free-standing lamp:  
black laquered metal structure;  
black plissé lamp shade





Rivalto 95002 03/04  
Hanging lamp:  
white plissé lamp shade



Rivalto 95002 07/08  
Table lamp:  
black lacquered metal structure;  
black plissé lamp shade



Oriani 95003  
Hanging lamp:  
bronze/brass cable







Marrakesh  
Wallpaper:  
oil blue;  
mustard yellow decoration

### il decoro, il contemporaneo decor, contemporary

---

Un'antica arte riprende vita e si tinge delle espressioni più contemporanee e vitali. Il desiderio di personalizzare ogni singolo punto del proprio living, vive e respira grazie alle carte da parati, i cui colori, le cui forme, le cui fantasie sanno concedere grazia oppure forza, levità oppure colore, ad ogni stanza. Tutto si forma in un gioco di colori e geometrie, in un caso, e disegni e luce nell'altro. Vi è, qui, la possibilità di arricchirsi di ogni variante possibile.

---

An ancient art comes back to life and gains the most contemporary and lively expressions. The wish for a completely customized realization in your own living space lives and breathes, thanks to these wallpapers. The colors, the shapes, the decorations, give grace rather than strength, lightness rather than color. In every single room. Everything takes shape in a game of colors and geometries, from one side, and drawings and light, from the other. Here, we have the chance to enrich oneself with every possible variation.



Intarsio  
Wallpaper:  
inlay,  
blue and grey



Boiserie  
Wallpaper:  
grey relief decoration,  
boiserie effect

**Villa Antica**  
Wallpaper:  
Villa Antica style;  
beige decoration



**Rombi**  
Wallpaper:  
rhombus;  
grey and avio



wonderwall  
a true wonderwall

---

Ogni stanza desidera essere deliziosa in ogni sua parte, a partire dai dettagli più minuti, e via via completandosi con gli oggetti più visibili. Le nostre carte da parati suggeriscono stupore, un desiderio di vita pensato per espandere l'universo della propria casa, e renderlo infinitamente prezioso.

---

A room should be delightful in every possible way, starting from the smallest detail, and going up to the most in-sight objects. Our wallpapers suggest a wonder, a lust for life thought to expand the universe of your own home, and to make it the most precious.





# farfa

---

Farfa è un tappeto a filato industriale con tessuto pied-de-poule e frange. Disponibile nelle versioni bianco e grigio, o ecru e rosso marsala.

Farfa is a fringed, machine woven rug, made of pied-de-poule fabric. Versions: white and grey; ecru and marsala red.

Farfa — бахромистый ковер машинного тафтинга, сделанный из ткани с узором pied-de-poule ("куриная лапка"). Версии: белый и серый; экрю и красный марсала.

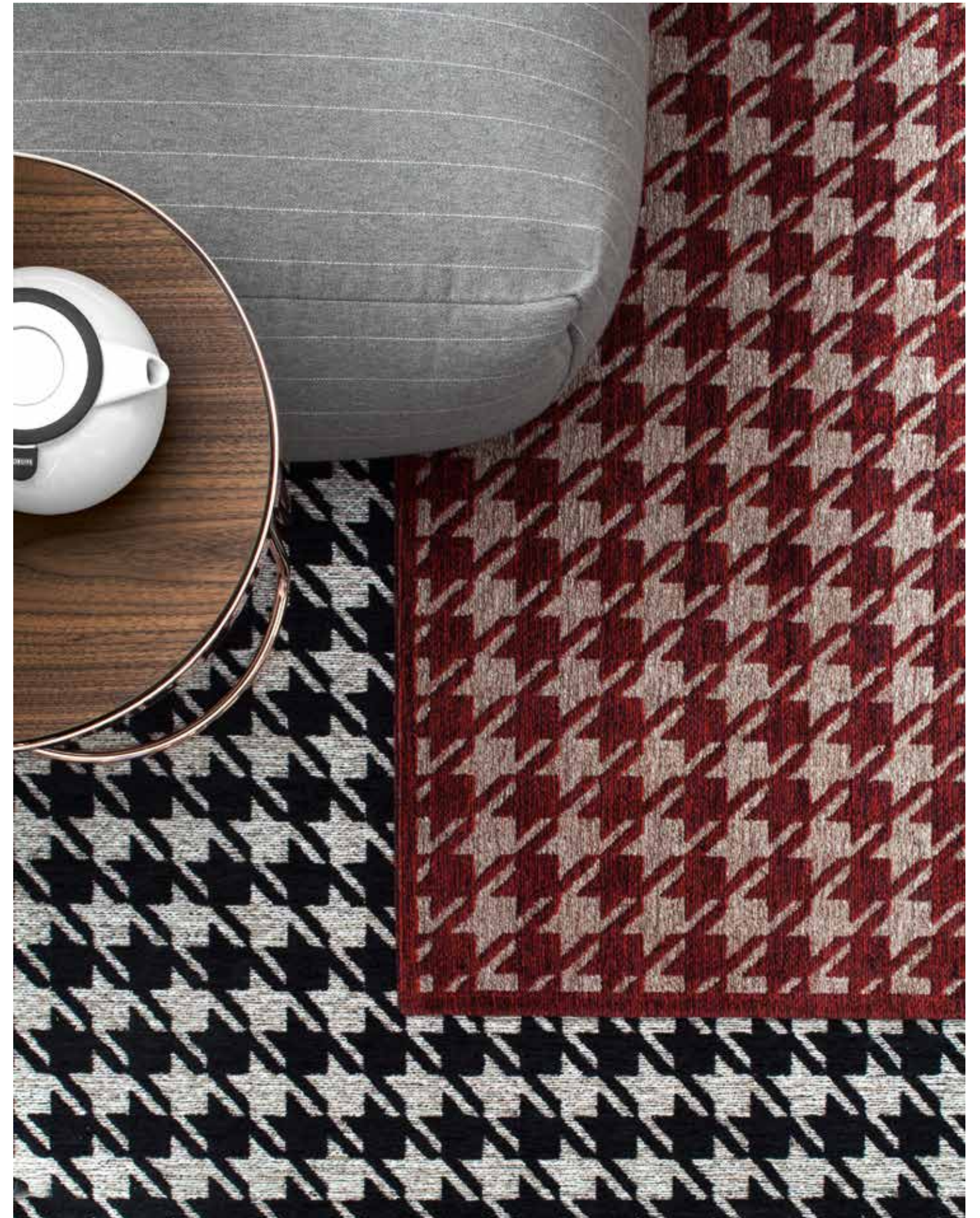



# boccioni

---

Boccioni è un tappeto a filato industriale, con un intarsio vintage nelle finiture color ecru e nero, o color marsala e testa di moro.

Boccioni is a machine woven rug with a vintage inlay. Versions: ecru and black; marsala red and dark brown.

Боссиони — это ковер машинного тафтинга с винтажной мозаикой. Расцветки: экрю и черный; марсала красный и темно-коричневый.



# volta

---

Volta è un tappeto filato a mano, con un patchwork originale, disponibile nelle varianti in color grigio Avio, color sabbia, color turchese, color rosso ossido e color giallo ocra.

Volta is a hand woven, patchwork rug. Versions: Avio grey; sand; turquoise; red oxide; ochre yellow.

Volta — ковер в стиле пэчворк ручной работы. Расцветки: Avio серый; песочный; бирюзовый; красный оксид; буровато-желтый.

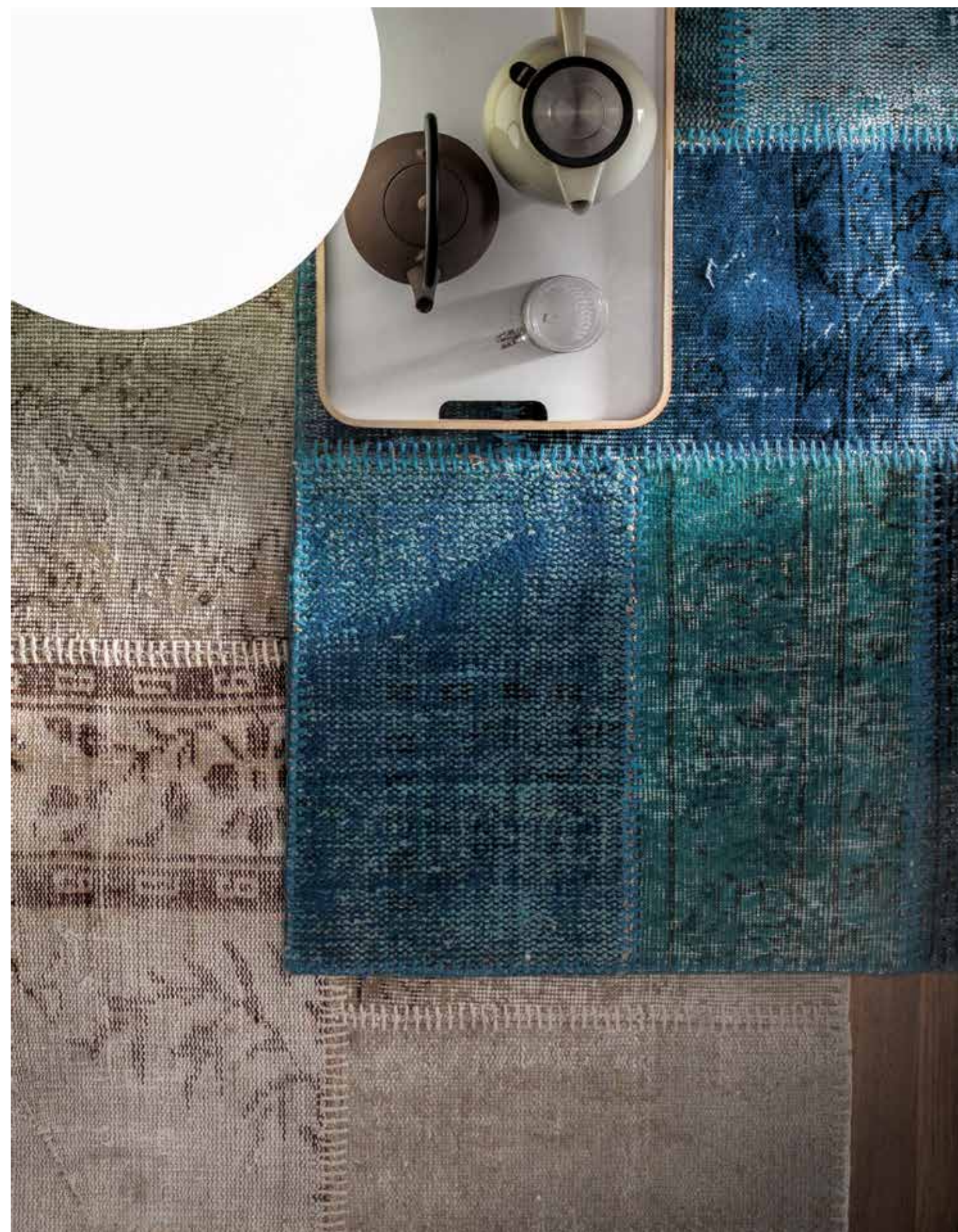

# palmanova

---

Palmanova è un tappeto a filato industriale, impreziosito da un damasco centrale e da frange. Disponibile in un melange nero e oro, o nero e argento.

Palmanova is a fringed, machine woven rug, with a precious central damask. Versions: black and gold; black and silver.

Palmanova — бахромчатый новер машинного тафтинга с дорогим центральным дамасковым узором. Модели: черный и золотой; черный и серебристый.



# giotto

---

Giotto è un tappeto a filato industriale, con una fantasia a rombi di colore bianco e nero, e impreziosito da frange.

Giotto is a black and white, fringed, rhombus patterned, machine woven rug.

Giotto — черно-белый бахромчатый ковер машинного тафтинга в ромб.





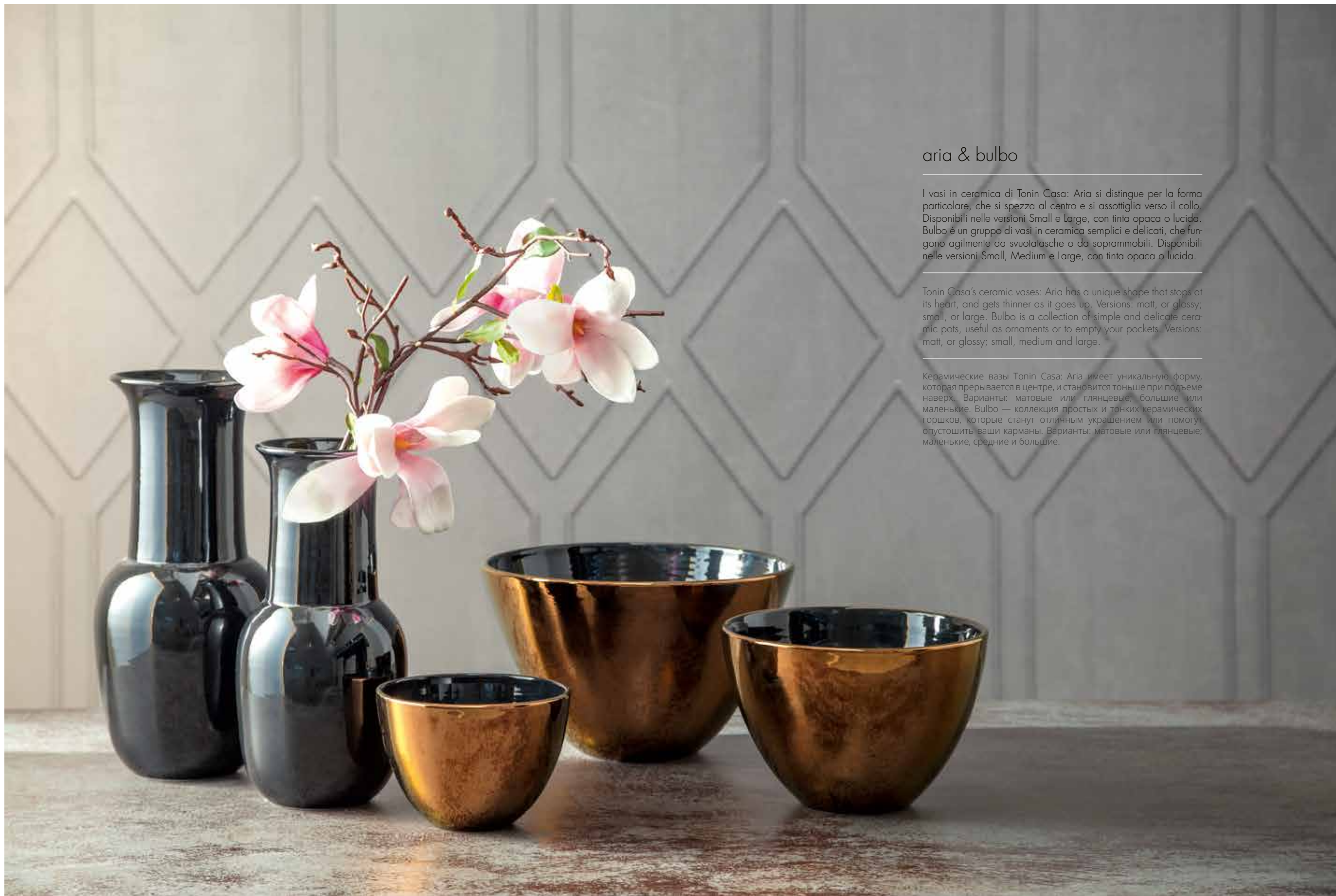

## aria & bulbo

I vasi in ceramica di Tonin Casa: Aria si distingue per la forma particolare, che si spezza al centro e si assottiglia verso il collo. Disponibili nelle versioni Small e Large, con tinta opaca o lucida. Bulbo è un gruppo di vasi in ceramica semplici e delicati, che fungono agilmente da svuotatasche o da soprammobili. Disponibili nelle versioni Small, Medium e Large, con tinta opaca o lucida.

Tonin Casa's ceramic vases: Aria has a unique shape that stops at its heart, and gets thinner as it goes up. Versions: matt, or glossy; small, or large. Bulbo is a collection of simple and delicate ceramic pots, useful as ornaments or to empty your pockets. Versions: matt, or glossy; small, medium and large.

Керамические вазы Tonin Casa: Aria имеет уникальную форму, которая прерывается в центре, и становится тоньше при подъеме вверх. Варианты: матовые или глянцевые; большие или маленькие. Bulbo — коллекция простых и тонких керамических горшков, которые станут отличным украшением или помогут опустошить ваши карманы. Варианты: матовые или глянцевые; маленькие, средние и большие.

## cin cin

---

Splendida unione di bicchieri e bottiglie in ceramica, eccellenti per rendere vivo e affascinante il vostro living. Sia le bottiglie che i bicchieri sono disponibili nelle versioni in ceramica opaca o lucida.

A marvelous marriage of ceramic glasses and bottles, the perfect ornaments to complete your living room. Versions: matt, or glossy ceramic.

Чудесное сочетание керамических стаканов и бутылок, идеальные украшения для дополнения гостиной. Варианты: матовые, глянцевые или керамические.



# vulcano

---

Vulcano: un gruppo di vasi che si ispira a forme montuose, e si divide tra il vaso Fumo, snello come un camino, e il vaso Lava, ampio e capiente. Entrambi sono disponibili nelle versioni Small e Large, con tinta opaca o lucida.

Vulcano: a collection of vases inspired by the mountains. Fumo, a thin, chimneylike vase; Lava, a wide and abundant pot. Versions: matt, or glossy; small, or large.

Vulcano: коллекция ваз, вдохновленных горами. Fumo — тонкая трубообразная ваза; Lava — широкий и вместительный горшок. Варианты: матовые или глянцевые; большие или маленькие.





## nido & adamo ed eva

---

Gruppo di vasi in ceramica dalla forma ampia e quasi ancestrale, Nido ricorda ad un primo impatto lavorazioni semplici e antiche. I vasi sono disponibili nelle versioni Small e Large, con tinta opaca o lucida. Una coppia di vasi che si completa, per altezze e forma: stretta al centro e allargata alle estremità, la forma di Adamo; femminilmente arcuata al centro quella di Eva. Disponibili nelle versioni Small e Large, con tinta opaca o lucida.

A group of ceramic pots, wide and almost ancestral: Nido reminds ancient and simple manufactures. Versions: matt, or glossy; small, or large. A couple of vases, completing each other: Adamo is wide at the bottom and the top, and thinner in the middle; Eva is feminine and arched in the middle. Versions: matt, or glossy; small, or large.

Группа керамических горшков, широких и почти исконных: Nido напоминает древних и простых производителей. Варианты: матовые или глянцевые; большие или маленькие. Пара ваз, дополняющая друг друга: Adamo широка в нижней и верхней частях, и тоньше в середине; Eva женственна и изогнута в середине. Варианты: матовые или глянцевые; большие или маленькие.



# grid

---

Una splendida gabbietta decorativa realizzata in filo metallico e disponibile in diverse finiture. La perfetta compagna della nostra libreria Tweet.

A wonderful little cage, a metal wired ornament, with several finishes available. The perfect companion, for our Tweet bookcase.

Очаровательная маленькая клетка, орнамент металлических прутьев с несколькими отделками. Идеальный компаньон для нашего книжного шкафа Tweet.





## sailon

Il complemento ultimo, il decoro finale e perfetto, capace di dare un tocco decisivo all'aspetto del vostro living. I cuscini Sailon si offrono in una vasta gamma di tessuti, che possono essere combinati nelle varianti di forma rotonda, quadrata, rettangolare e rettangolare capitonné.

The icing on the cake, the last, perfect decoration, capable of giving the final touch to your living-room. Sailon pillows are covered in several fabrics, available for each shape: round, square, rectangular and Capitonné rectangular.

Глазурь на торте, последнее, совершенное украшение, которое придаст последний штрих вашей гостиной. Подушки Sailon с несколькими разновидностями тканей, доступные в различных формах: круглые, квадратные, прямоугольные и прямоугольные Capitonné.

specifiche  
specifications

adachi

8155 Ø 50 H 63  
8155H Ø 50 H 73

piano - top ( V\_81 - V\_100 ) / base - base ( 501 - 501 - 560 )

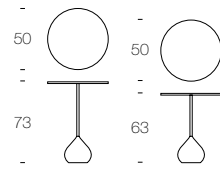

adele

6033 L 72 P 81 H 34

piano - top ( 01 - 02 - 83 ) / struttura - structure ( 14 - 16 - 17 )

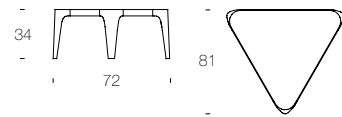

aida

6037 L 49 P 47 H 50  
6038 L 93 P 90 H 34

piano - top ( 14 - 16 ) / struttura - structure ( V\_81 - V\_100 )

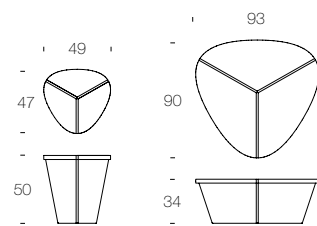

airone

6272 L 46 P 36 H 68

struttura - structure ( 01 - 02 - 14 - 16 )

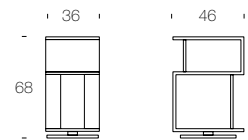

alaric

6223 L 142 P 70 H 30

struttura - structure ( V\_81 - V\_100 - V\_85 )

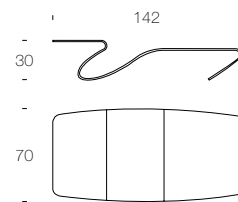

alga

7416 Ø 40 H 177

struttura - structure ( 01 - 36 - 10 - 68 - 83 )

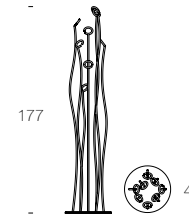

alissa

6806E L 117 P 78 H 37  
6806RM L 120 P 64 H 37

struttura - structure ( V\_81 - V\_84 - V\_85 - V\_100 )

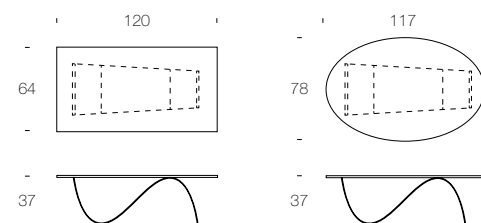

specifiche - specifications

per il campionario completo vedi le pagine finali  
for the complete samples see the final pages

amaranto

6811 L 130 P 68 H 37

piano - top ( V\_2 - V\_101 - 14 - 16 ) / struttura - structure ( V\_81 - V\_85 - V\_100 )

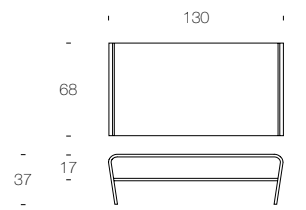

amburgo

6285 Ø 55 H 55  
6286 Ø 70 H 40  
6287 Ø 100 H 30

piano - top ( V\_2 - V\_101 - V\_136 - V\_73P - V\_01P - V85P ) /  
struttura - structure ( 72 - 76 )

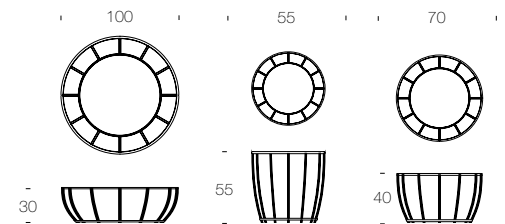

amira

6273 Ø 61 H 36  
6274 Ø 45 H 50

piano - top ( 14 - 16 - 17 ) / struttura - structure ( 300 - 301 - 305 - 304 - 303 - 302 )

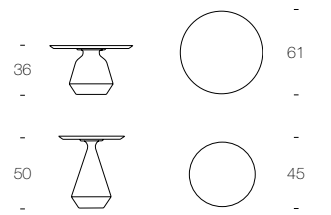

andorra

6293 Ø 40 H 52

piano - top ( V\_2 - V\_101 - 14 - 16 - 17 - V\_73P - V\_01P - V\_85P ) /  
struttura - structure ( 01 - 02 - 72 - 10 )

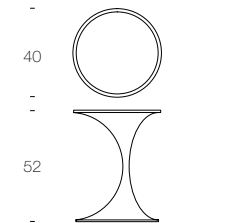

andra

6934 (A) L 90 P 60 H 30 - (G) L 120 P 86 H 30  
6936 (P) L 50 P 36 H 64

piano - top ( V\_602 - V\_601 ) / struttura - structure ( 01 - 02 )

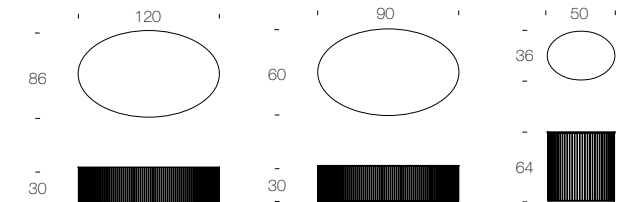

anemone

6829 L 44 P 52 H 45  
6846 L 40/48/56 P 40/44/48 H 37/41/45  
6850 L 110 P 60 H 37

6829 piano - top ( 14 - 16 ) / struttura - structure ( V\_81 - V\_85 - V\_84 - V\_100 )  
6846 struttura - structure ( V\_81 - V\_85 - V\_84 - V\_100 )  
6850 struttura - structure ( V\_85 - V\_84 - V\_100 - V\_81 )

ariel

6814 Ø 60 H 36  
6814 L 100 P 60 H 37

struttura - structure ( V\_81 - V\_100 - V\_85 )

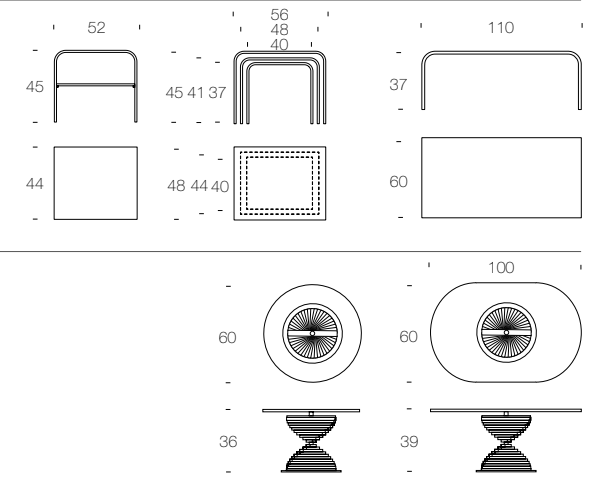

specifiche - specifications

per il campionario completo vedi le pagine finali  
for the complete samples see the final pages

arona

6212 L 145 P 65 H 30

piano - top ( V\_81 - V\_100 ) / base - base ( 14 - 16 )

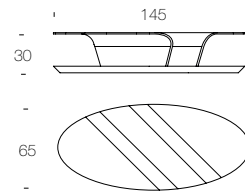

beside

8167 SX/DX L 49 P 50 H 53

struttura - structure ( V\_81 - V\_85 - V\_100 )

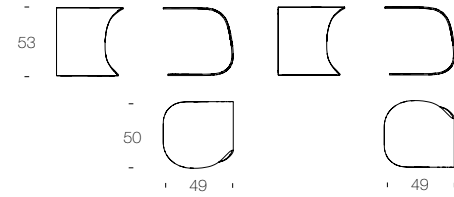

book

7492 L 54 P 35 H 30

piano - top ( 60 - 68 - 01 ) / struttura - structure ( 14 - 16 - 17 )

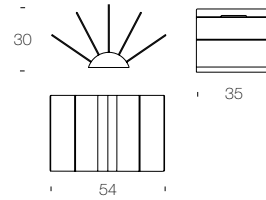

central

6281 L 100 P 100 H 30

6282 L 50 P 50 H 50

6284 L 100 P 55 H 30

piano - top ( V\_101 - 14 - 16 - V\_73P - V\_01P - V\_85P ) / struttura - structure ( 72 - 10 )

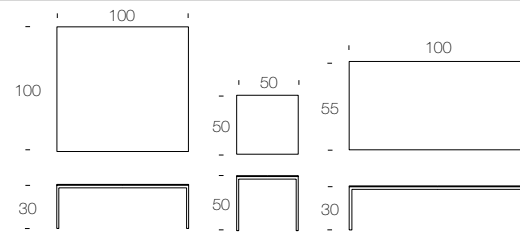

celine

6021 L 44 P 42 H 55

6021H L 44 P 45 H 65

piano - top ( 01 - 02 - 17 - 20 ) / struttura - structure ( 01 - 02 )

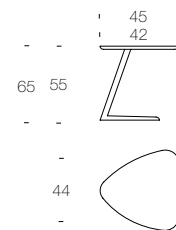

chakra

6875 L 85 P 80 H 38

6876 L 46 P 42 H 50

piano - top ( 14 - 16 ) / struttura - structure ( V\_85 - V\_100 )

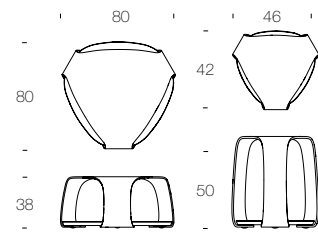

cora

6035P Ø 40 H 48

6035A L 80 P 40 H 38

6035G L 110 P 40 H 38

piano - top ( 14 - 16 - V\_73P - V\_01P - V\_85P ) / struttura - structure ( 83 - 76 - 75 )

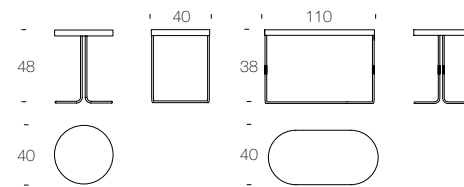

specifiche - specifications

per il campionario completo vedi le pagine finali  
for the complete samples see the final pages

cortes

7095G L 130 P 42 H 125

pannello - panel ( 01 - 14 - 16 ) / ripiano in vetro - glass shelf ( V\_85 - V\_101 ) /  
struttura - structure ( 01 - 10 )

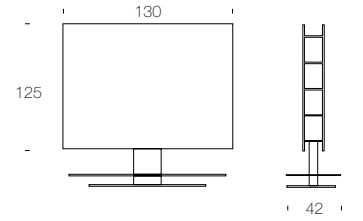

cruz

6878 L 122 P 42 H 35

6879 L 42 P 42 H 50

piano - top ( 14 - 16 ) / struttura - structure ( 83 - 76 - 75 )

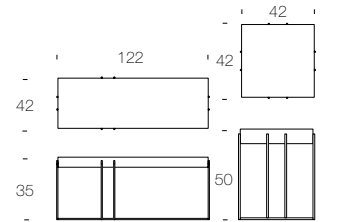

detroit

8156 L 50 P 50 H 51

8156H L 50 P 50 H 61

piano - top ( V\_101 - 14 - 16 - V\_73P - V\_01P - V\_85P ) / struttura - structure ( 72 - 10 )

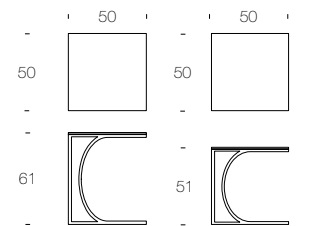

dubai

6608 L 120 P 70 H 38

piano - top ( V\_81 - V\_100 - V\_2 - V\_101 - V\_160 ) / struttura - structure ( 501 - 502 - 560 - RAL )

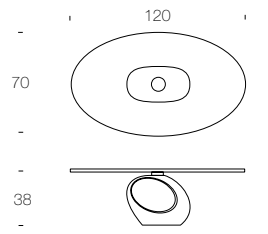

fly

7491 L 65 P 38 H 28

struttura - structure ( S\_01 - S\_40 - S\_36 - S\_51 - S\_70 - S\_59 - S\_77 - S\_02 )

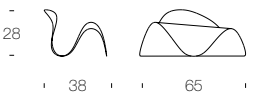

ios

8191 L 47 P 51 H 50

8191PB L 47 P 51 H 50

8191PF L 47 P 51 H 55

8191PL L 47 P 51 H 50 ♀

8191BL L 47 P 51 H 50 ♂

8191 piano - top ( X\_81 - X\_02 - X\_22 - X\_62 - X\_85 - 14 - 16 - 17 ) / struttura - structure ( 01 - 36 - 64 - 60 - 54 )

8191PB piano - top ( X\_81 - X\_85 ) / struttura - structure ( 01 - 36 - 64 - 60 - 54 )

8191PF rivestimento cuscino - cushion covering ( TO - TN ) / struttura - structure ( 01 - 36 - 64 - 60 - 54 )

8191PL piano - top ( X\_02 - X\_22 - X\_62 - X\_81 - X\_85 - 14 - 16 - 17 ) / struttura - structure ( 48 )

8191BL piano - top ( X\_81 - X\_85 ) / struttura - structure ( 48 )

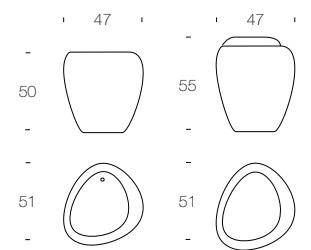

specifiche - specifications

per il campionario completo vedi le pagine finali  
for the complete samples see the final pages

ivy

7418 L 14 P 8 H 18  
L 12 P 7 H 14

struttura - structure ( 501 - 503 )

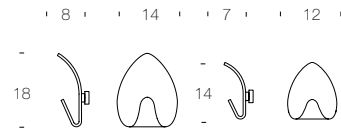

kos

8190 L 112 P 95 H 33  
8190L L 112 P 95 H 33 Q

8190 piano - top ( X\_81 - X\_02 - X\_22 - X\_62 - X\_85 - 14 - 16 - 17 ) / struttura - structure ( 01 - 36 - 64 - 60 - 54 )  
8190L piano - top ( X\_81 - X\_02 - X\_22 - X\_62 - X\_85 - 14 - 16 - 17 ) / struttura - structure ( 48 )

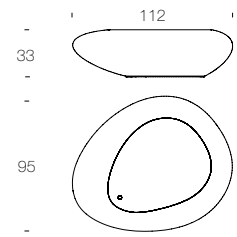

log

6019 L 105 P 100 H 40

struttura - structure ( 83 - 76 - 75 ) piani - tops

( ver1. BIG: M\_183; MED: 68; SMALL: 14 )  
( ver1. BIG: M\_101; MED: 68; SMALL: 17 )  
( ver1. BIG: M\_29; MED: 68; SMALL: 14 )  
( ver1. BIG: M\_183; MED: 68; SMALL: 16 )  
( ver1. BIG: 01; MED: 68; SMALL: 17 )

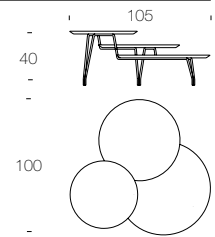

logos

7005 L 135 P 53 H 72

piano - top ( 14 - 16 ) / struttura - structure ( 83 ) / inserto in pelle - leather insert ( P\_02 )

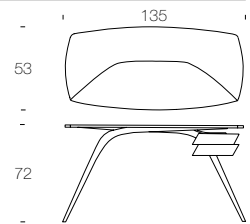

maki

6234 Ø 27/42 H 51  
6234L Ø 27/42 H 51 Q

6234 piano - top ( X\_81 - X\_85 - 14 - 17 ) / struttura - structure ( 01 - 07 - 64 - 60 - 54 )  
6234L piano - top ( X\_81 - X\_85 - 14 - 17 ) / struttura - structure ( 48 )

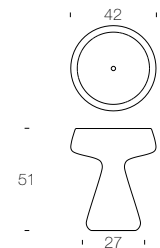

matrioska

6278 L 120 P 71 H 36

struttura legno - wooden structure ( 14 - 16 ) / struttura metallica - metal structure ( 83 )

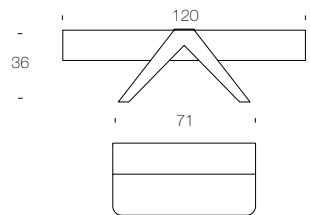

narciso

7490 L 34 P 44 H 72

struttura - structure ( 01 - 36 - 10 - 83 - 68 )

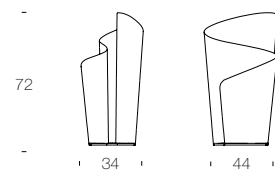

specifiche - specifications

per il campionario completo vedi le pagine finali  
for the complete samples see the final pages

pandora

6011 Ø 60 H 41  
6012 Ø 45 H 47

combinazioni - combinations

( A. BASE: M\_101 + 17 + V\_trasparente + platino + TOP: 17 )  
( B. BASE: M\_101 + 17 + V\_grey + platino + TOP: 17 )  
( C. BASE: M\_129 + 14 + V\_ambra + oro + TOP: 14 )  
( D. BASE: M\_102 + 16 + V\_rosa + platino + TOP: 16 )

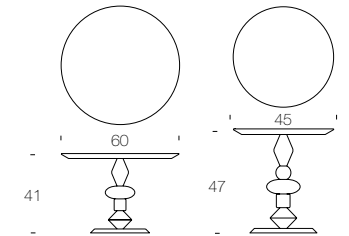

paroli

7315 L 160 P 60 H 30  
7315P L 130 P 60 H 30

piano - top ( M\_101 - M\_102 ) / struttura - structure ( 72 - 10 )

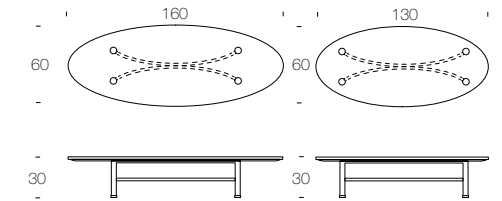

pavones

8105 L 120 P 60 H 39

piano - top ( V\_81 - V\_100 - V\_101 ) / struttura - structure ( 72 )

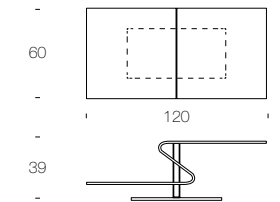

plissé - pouf/pouf

7335P Ø 69 H 35  
7335A Ø 84 H 36  
7335G Ø 114 H 38

struttura - structure ( S )

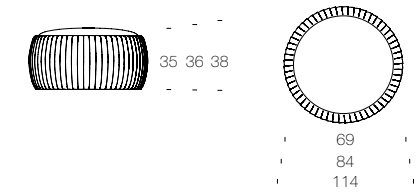

plissé - tavolino/coffee table

7336P Ø 69 H 30  
7336A Ø 84 H 30  
7336G Ø 114 H 30

piano - top ( V\_2 - V\_601 - V\_136 - V\_73P - V\_01P - V\_85P ) / struttura - structure ( S )

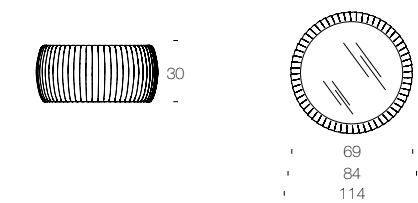

quiet

8194 L 106 P 106 H 33

piano - top ( V\_81 - V\_85 + V\_100 ) / base - base ( 01 - 14 )

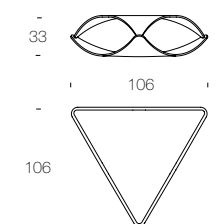

raffaello

6208 L 92 P 88 H 35

piano - top ( 14 - 16 ) / struttura - structure ( V\_81 - V\_100 - V\_85 )

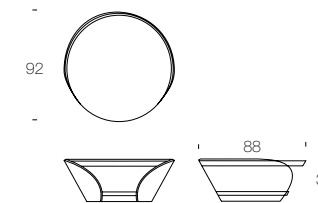

specifiche - specifications

per il campionario completo vedi le pagine finali  
for the complete samples see the final pages

rea

6300 L 60 P 60 H 46  
6303 L 60 P 88 H 34

struttura - structure ( 14 - 16 )

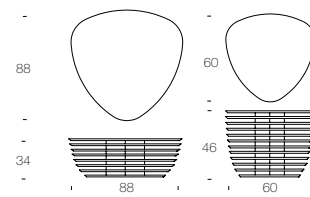

rimini

6232 Ø 84 H 39  
6233 Ø 39 H 50

piano - top ( V\_85 - V\_602 - V\_601 - V\_636 ) / struttura - structure ( 01 - 02 - 83 ) /  
base in marmo - marble base ( M\_101 - M\_102 - M\_183 )

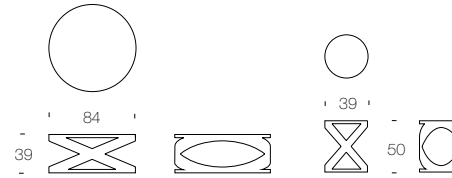

space

6296 L 52 P 40 H 55  
6297 L 110 P 85 H 33

combinazioni - combinations ( A. monocolore / monocolor: 01 - 02 )  
( B. bicolore / bicolor: 01 - Top 14 )  
( C. versione legno / wooden version: 14 )

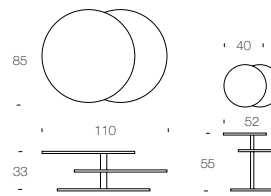

spiga

7415(P) Ø 35 H 172  
7415(G) Ø 35 H 186  
7415L(P) Ø 35 H 172 Q  
7415L(G) Ø 35 H 186 Q

7415(P) - 7415(G) struttura - structure ( 01 - 03 - 36 - 64 - 60 - 54 )  
7415L(P) - 7415L(G) struttura - structure ( 48 )

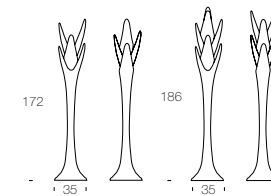

tree

6298 Ø 85 H 32  
6299 Ø 40 H 56

piano - top ( 01 - 02 - 14 - 17 ) / struttura - structure ( 01 - 02 - 83 )

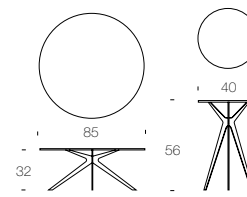

tudor

6630 L 117 P 78 H 34  
6630 L 120 P 65 H 36

piano - top ( V\_81 - V\_100 ) / struttura - structure ( 501 - 502 - 551 )

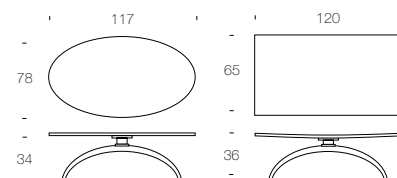

truly

7300 L 50 P 50 H 40  
7301 L 70 P 70 H 40

rivestimenti - covering ( S - GT - TP - TV - TN - SN - T\_ \_V )



specifiche - specifications

per il campionario completo vedi le pagine finali  
for the complete samples see the final pages

velo

8166 L 95 P 76 H 33

struttura - structure ( V\_81 + V\_85 o/or V\_100 )

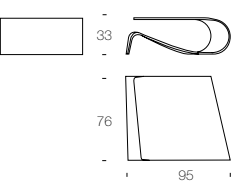

volup

8195 L 84 P 88 H 36

struttura - structure ( V\_81 + V\_85 o/or V\_100 )

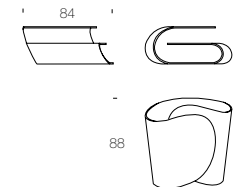

wood

7419 L 108 P 43 H 170

piano - top ( 01 - 68 - 60 ) / struttura - structure ( 14 - 16 - 17 )

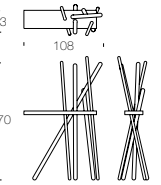

arpa

6470 L 116 P 46 H 77

piano - top ( V\_101 - V\_136 - M\_101 - M\_102 - M\_183 - V\_73P - V\_01P - V\_85P ) /  
struttura - structure ( 14 - 16 - 01 )

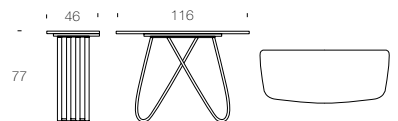

albatros

6440 L 120 P 25 H 25  
6441 L 70 P 02 H 13

piano - top ( 14 - 16 - 17 ) / struttura - structure ( 01 - 02 - 83 - 68 )

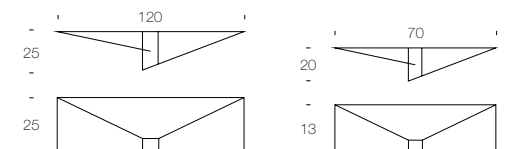

altamura

6460 L 108 P 43 H 170

piano - top ( V\_02 - V\_101 - V\_136 - 14 - 16 ) / struttura - structure ( V\_81 - V\_100 - V\_85 )

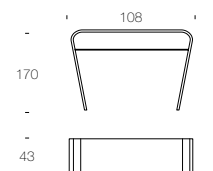

sunset

7501 L 160 P 36 H 120

mensola - shelf ( 14 - 16 ) / specchio - mirror ( V\_45 - V\_184 ) / optional - optional ( PO )

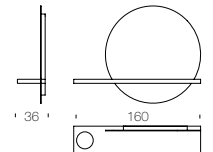

specifiche - specifications

per il campionario completo vedi le pagine finali  
for the complete samples see the final pages



tiffany

6436 L 136 P 40 H 74

rivestimento - covering ( S - P - PF - PN - SN ) / struttura - structure ( 14 - 16 - 17 )

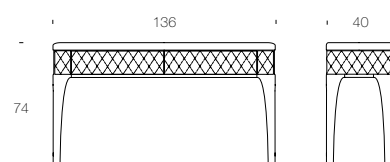

alicante

7504C L 71 P 20 H 180

7504A L 71 P 20 H 180

appendini - hangers ( 14 - 16 ) / struttura - structure ( V\_45 - V\_184 ) / optional - optional ( PO )

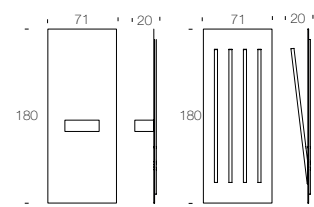

callas

7528(Q) L 110 P 6 H 110

7528(R) L 108 P 6 H 200

struttura - structure ( V\_81 - V\_85 )

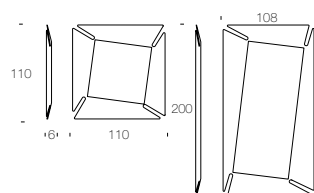

costantia

7519(SR) L 106 H 200

7519(SQ) L 130 H 130

7519(SQP) L 106 H 106

struttura - structure ( V\_45 - V\_184 )

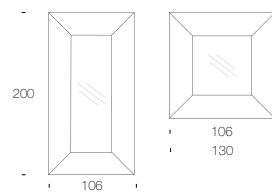

imperia

7527 L 90 P 11 H 78

struttura - structure ( V\_45 - V\_184 )

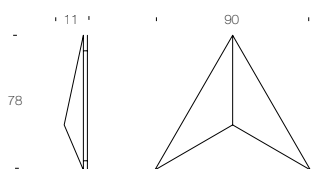

marguerite

6465 p. L 40 H 80

6465 m. L 80 H 80

6465 g. L 50 H 160

specchi - mirrors ( V\_45 - V\_184 ) / struttura - structure ( 14 - 13 )

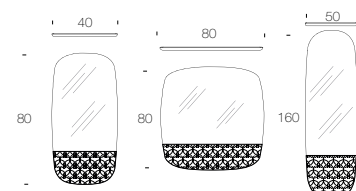

olmi

7300 L 55 H 180

rivestimenti - covering ( V\_02 - V\_84 - V\_101 - V\_160 )



specifiche - specifications

per il campionario completo vedi le pagine finali  
for the complete samples see the final pages

kolonaky

7526 L 31 P 31 H 170

struttura - structure ( S - P - PF - PN - SN )

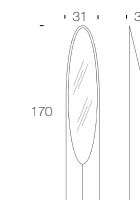

skin

7530 L 54 P 3 H 34

struttura - structure ( V\_45 - V\_184 )

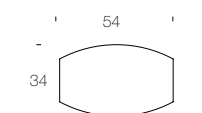

stone

7529(P) L 66 P 3 H 83

7529(A) L 90 H 114

7529(G) L 121 H 152

struttura - structure ( V\_45 - V\_184 )

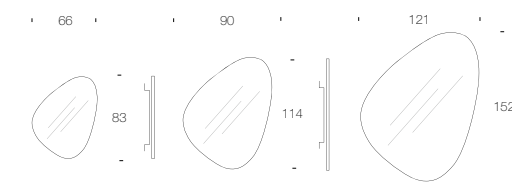

toshima

5030 L 64 H 168

5032 L 80 H 80

struttura - structure ( V\_02 - V\_84 - V\_101 - V\_160 )

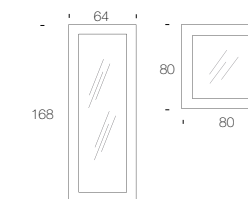

ago e filo

9105(OOSP) L 50 H 25

9105(OOP) L 120 P 50 H 185

9105(OOSP) cavo rosso con paralume cotonette - red cable; cotonette lamp shade  
9105(OOP) versione cromo, cavo rosso con paralume cotonette - chrome version: red cable; cotonette lamp shade

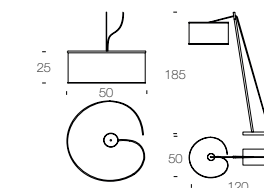

atomo

9102(A) L 40 H 50

9102(S) L 40 H 120

combinazioni - combinations ( A. Sfera A: Fumè trasp., Sfera B: Trasp. e Sfera C: Rame - A sphere: grey fumé; B sphere: copper and C sphere: transp. )  
Comprendivo di tre LED G9 ( B. Sfera A: Azzurro trasp., Sfera B: Trasp. e Sfera C: Bronzo - B sphere: light blue; B sphere: bronze and C sphere: transp. )  
3 G9 LED lamps included ( C. Sfera A: Fumè trasp., Sfera B: Trasp. e Sfera C: Bronzo - C sphere: grey fumé; B sphere: bronze and C sphere: transp. )  
( D. Sfera A: Ambra trasp., Sfera B: Trasp. e Sfera C: Bronzo - D sphere: amber; B sphere: bronze and C sphere: transp. )  
( E. Sfera A: Fumè trasp., Sfera B: Bronzo e Sfera C: Rame - A sphere: grey fumé; B sphere: bronze and C sphere: Copper )

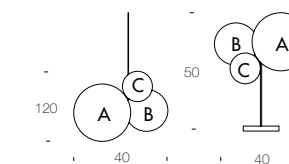

oriani

95003 Ø 13

versione 1 luce - 01 version: 1 light  
versione 2 luce - 02 version: 2 lights  
versione 3 luce - 03 version: 3 lights

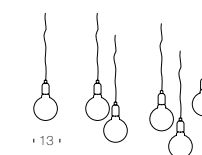

specifiche - specifications

per il campionario completo vedi le pagine finali  
for the complete samples see the final pages

rain

9100(P) P 7 H 40  
9100(G) P 7 H 60

vetro - glass ( trasparente, fumè, azzurra, ambra - transparent, fumé grey, light blue, amber )

Comprensivo di tre LED G9  
3 G9 LED lamps included

rivalto

95002(01/02) L 210 H 190  
95002(03/04) Ø 70 H 30  
95002(07/08) L 33 H 55

versione 1 bianca; plissettata - white, plissé  
versione 2 nera; plissettata - black, plissé

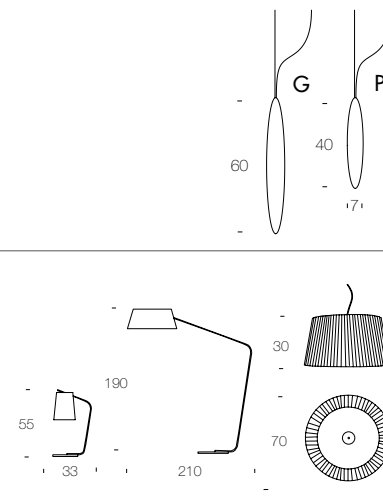

santena

95004 03 L 25 H 46  
95004 01 L 91 P 35 H 35  
95004 02 L 22 H 28

cristallo e cromo - crystal / chrome

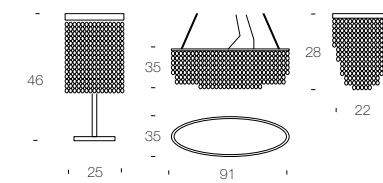

specifiche - specifications

per il campionario completo vedi le pagine finali  
for the complete samples see the final pages



finiture | finishing

strutture | structures

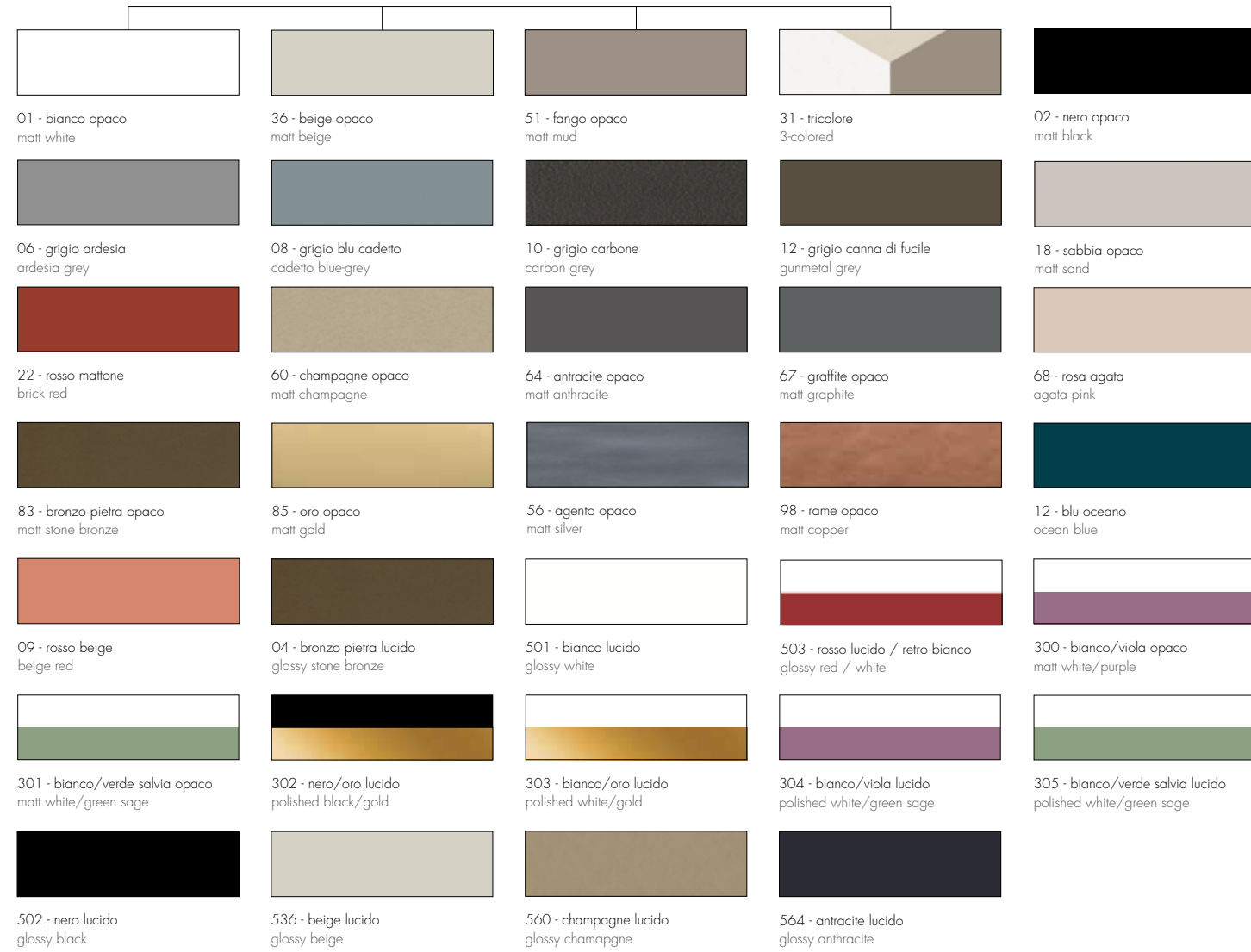

essenze | essences



finiture | finishing

laminato - L | laminated - L

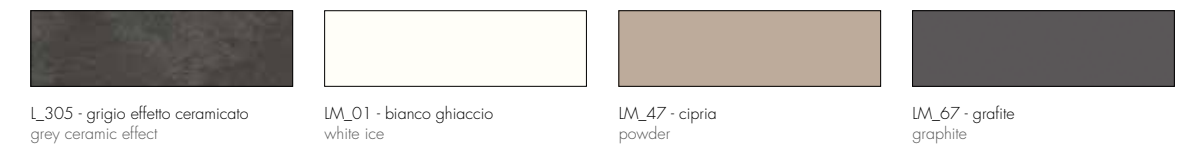

melaminico - L | melaminic - L

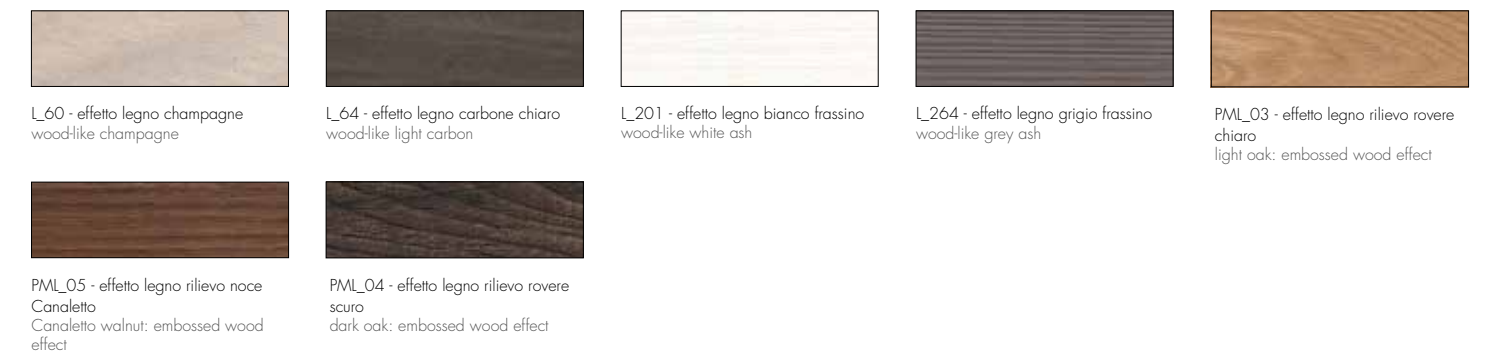

marmi - M | marbles - M



vetro ceramicato - V\_\_C | ceramic glass - V\_\_C



gres porcellanato - V\_\_P | porcelain stoneware - V\_\_P



finiture | finishing

vetri - V | glasses - V

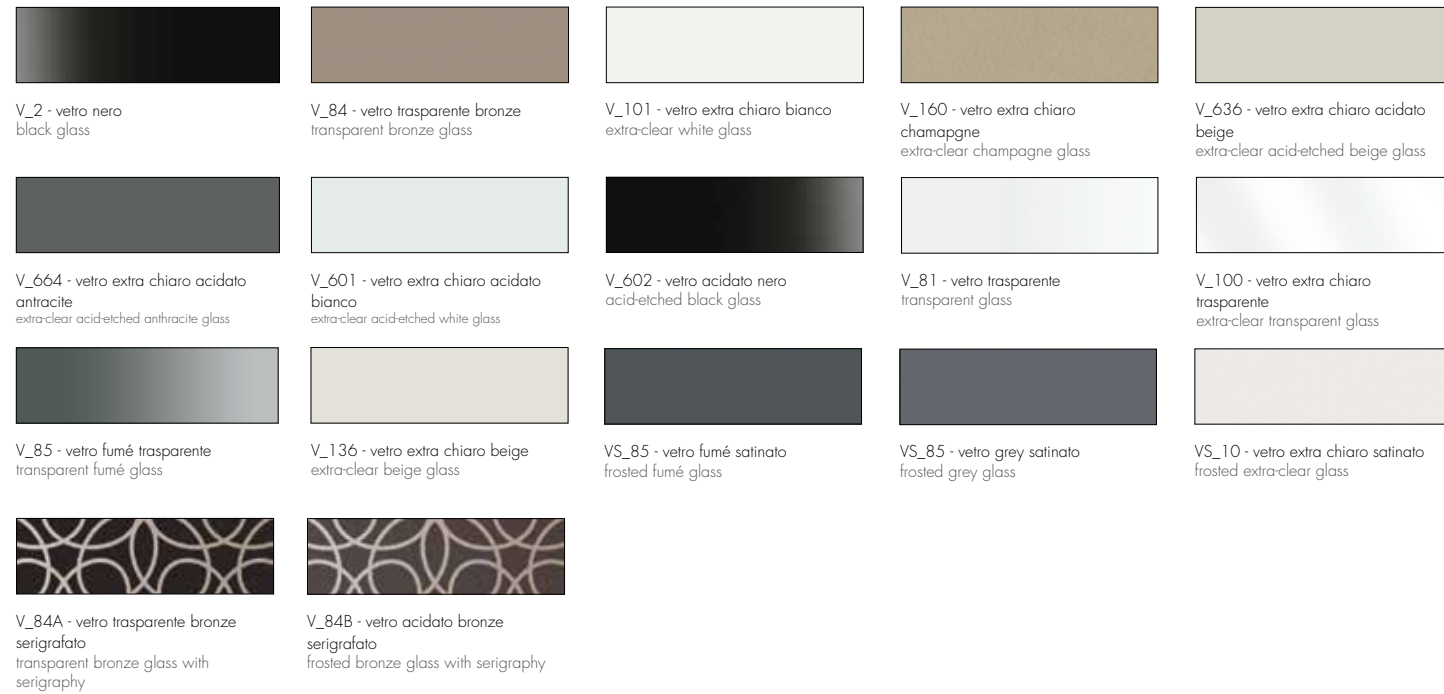

specchi - V | mirrors - V

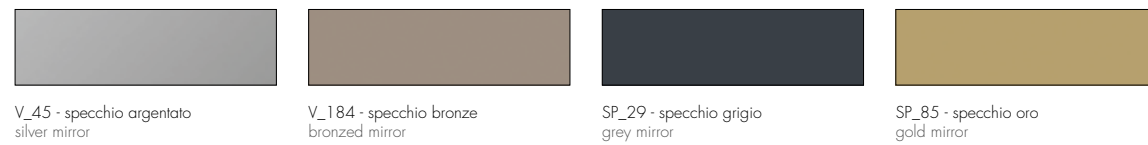

tecnoril | tecnoril



polietilene | polyethylene

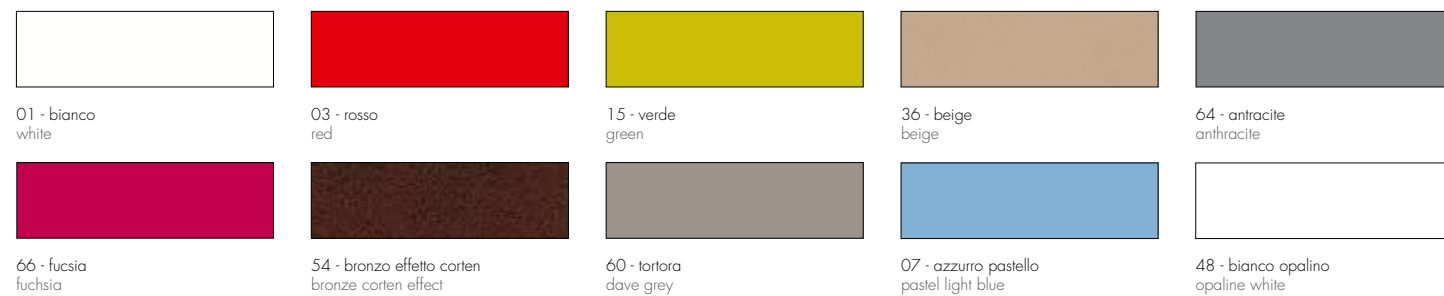

finiture | finishing

metalli | metals



cromo | chrome

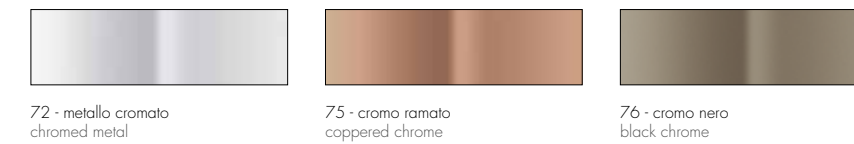

plexiglass - X | plexiglass - X

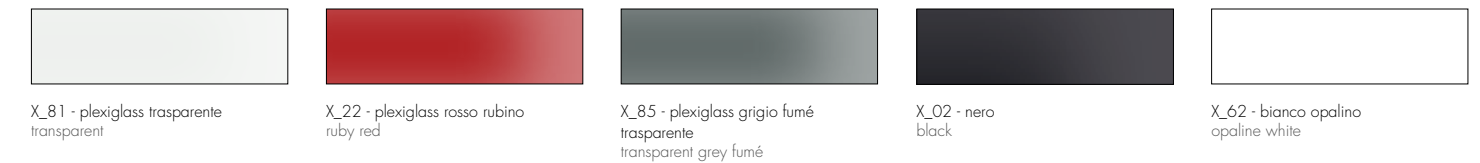

tessuti e pelli | fabrics and leathers

tessuto ninfea - TN | ninfea fabric - TN



TN\_04 - giallo cedro cedar yellow  
TN\_08 - mandorla almond  
TN\_16 - blu jeans jeans blue  
TN\_17 - verde polinesia polynesia green  
TN\_22 - tabacco tobacco  
TN\_29 - grigio gabbiano gull grey  
TN\_51 - fango mud  
TN\_65 - roccia rock

tessuto orchidea - TO | orchidea fabric - TO



TO\_01 - bianco white  
TO\_02 - nero black  
TO\_40 - blu turchese turquoise blue  
TO\_41 - rosso ciclamino cyclamen red  
TO\_51 - fango mud  
TO\_64 - grigio antracite anthracite grey  
TO\_70 - testa di moro dark brown

tessuto pied de poule - TP | pied de poule fabric - TP

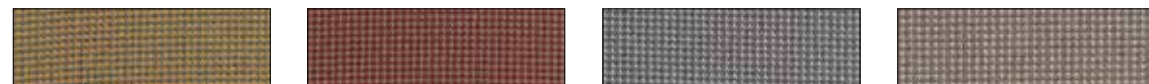

TP\_04 - giallo yellow  
TP\_03 - rosso mattone brick red  
TP\_64 - grigio grey  
TP\_60 - tortora dove grey

tessuto gessato - GT | gessato fabric - GT



GT\_04 - giallo yellow  
GT\_03 - rosso mattone brick red  
GT\_64 - grigio grey  
GT\_60 - tortora dove grey

tessuti e pelli | fabrics and leathers

tessuto mimosa - TK | mimosa fabric - TK



TK\_03 - rosso rubino ruby red  
TK\_04 - giallo yellow  
TK\_17 - verde brillante bright green  
TK\_34 - blu ottanio oil blue  
TK\_36 - beige beige  
TK\_60 - tortora dove grey

tessuto verbena - TV | verbena fabric - TV



TV\_01 - bianco white  
TV\_02 - nero black  
TV\_03 - rosso red  
TV\_04 - giallo yellow  
TV\_51 - fango mud  
TV\_64 - grigio antracite anthracite grey  
TV\_70 - testa di moro dark brown  
TV\_91 - sabbia sand

pelle nabuk - PN | nabuk leather - PN



PN\_2 - nero black  
PN\_5 - panna cream  
PN\_9 - rosso bordeaux burgundy red  
PN\_51 - fango mud  
PN\_70 - testa di moro dark brown  
PN\_73 - grigio grey  
PN\_100 - ecrù ecru

tessuti e pelli | fabrics and leathers

ecopelle - S | eco leather - S



cuoio - K | thick leather - K



tessuti e pelli | fabrics and leathers

pelle - P | leather - P

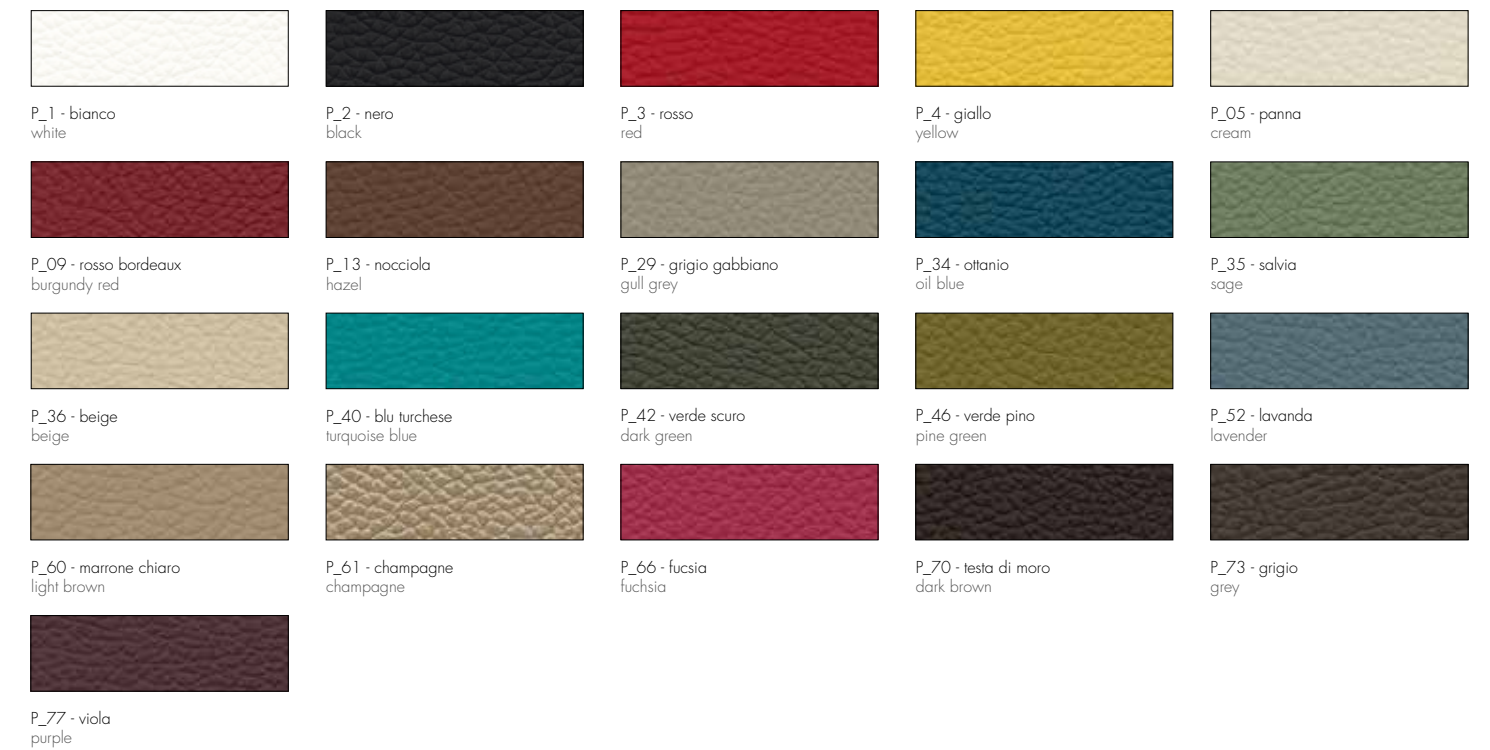

pelle fiore - PF | grain leather - PF



tessuti e pelli | fabrics and leathers

velluto vega - T\_ \_V | vega velvet - T\_ \_V

---



T02V - nero  
black



T03V - grigio marrone  
grey-brown



T04V - grigio camel  
camel grey



T05V - rosso ruggine  
rusty red



T06V - bordeaux antico  
old burgundy red



T07V - ottanio  
oil blue



T08V - verde menta  
mini green



T09V - glicine  
wisteria



T10V - blu profondo  
deep blue



T11V - seta  
silk



T12V - grigio caldo  
warm grey

cucitura a contrasto | contrast-stitching

---



0446 - blu universo  
universe blue



0410 - arancio riflesso  
reflected orange



0001 - bianco  
white



0002 - nero  
black

ecopelle nabuk - SN | nabuk eco-leather - SN

---



SN\_01 - panna  
cream



SN\_03 - ecrù  
ecrù



SN\_04 - nocciola  
hazel



SN\_05 - testa di mora  
dark brown



SN\_06 - grigio  
grey



SN\_10 - ottanio  
oil blue



SN\_13 - grigio seta  
silk grey



SN\_16 - rosso bordeaux  
burgundy red



Fondata da Gianni Tonin più di 40 anni fa, TONIN CASA è stata sin dall'inizio esempio di passione, eleganza e ricerca nel settore arredamento.

Nel 1975 la sua attività principale era il commercio di scarpiera e mobili classici, pubblicando il primo catalogo nel 1982.

Il successo e la fiducia dei clienti fecero sì che nei primi anni '90 venisse avviata la produzione di mobili moderni, accompagnati dall'edizione di cataloghi dedicati ed all'espansione dell'area commerciale oltre il Triveneto.

Tonin casa, da allora, è in costante sviluppo e crescita, impegnata nel commercio a livello mondiale e nell'esportazione dei valori del Made in Italy, con prodotti sintesi di bellezza e funzionalità. Segni e tendenze che promuovono la tradizione del Design Italiano nel mondo.

Founded by Gianni Tonin more than 40 years ago, TONIN CASA has been, since the very beginning, a perfect example of passion, elegance and research in the furniture business.

In 1975 its main activity was the production of shoe cabinets and classical furniture, publishing the first catalogue in 1982.

Due to its success and the trust from our clientele, at the beginning of the Nineties, we started our production of modern furniture, together with publishing of specific dedicated catalogues and the expansion to areas beyond Northern Italy.

Since then, TONIN CASA has been in a continuous development and growth, engaging into worldwide sales and exporting the values of Made in Italy, with products which resume beauty and functionality. Signs and trends that promote the tradition of Italian Design in the world.

Основанная Джанни Тонин более чем 40 лет назад, фабрика Tonin Casa была с самого начала примером страсти, элегантности и исследований в мебельной индустрии.

В 1975 году основным направлением его деятельности было торговля шкафчики для обуви и классической мебелью, издававши первый каталог в 1982 году.

Успех и доверие клиентов означало, что в начале 90-х было запущено производство современной мебели, сопровождаемое изданием каталогов, посвященных расширению торговой площади за пределами Тривенето.

Tonin Casa, с тех пор, находится в постоянном развитии и росте, занимается торговлей по всему миру и экспортное значения "Сделано в Италии", с продуктами синтеза красоты и функциональности. Признаки и тенденции, которые способствуют традиции итальянского дизайна в мире.

**Stampa:**

Grafiche Antiga

**Stampato in Italia Marzo 2017**

La ditta "Tonin Casa divisione della Progetto Design International s.r.l." si riserva la facoltà di modificare in qualunque momento e senza preavviso, le caratteristiche tecniche degli elementi usati nel presente catalogo.

Alcuni accessori presenti nelle immagini fotografiche non sono prodotti dalla ditta "Tonin Casa divisione della Progetto Design International s.r.l." Si prega di far riferimento al listino prezzi.

La ditta "Tonin Casa divisione della Progetto Design International s.r.l." si riserva inoltre il diritto di apportare ai propri prodotti quelle modifiche che si riterranno necessarie o utili al fine di migliorarli senza pregiudicarne le caratteristiche essenziali.

È vietata ogni riproduzione totale e parziale in Italia e all'estero.

"Tonin Casa divisione della Progetto Design International s.r.l." reserves the right to modify the technical characteristics of the elements shown in this catalogue, at any time and without notice.

Some of the accessories shown in the photos are not produced by "Tonin Casa divisione della Progetto Design International s.r.l.". Please refer to price-list.

"Tonin Casa divisione della Progetto Design International s.r.l." also reserves the right to make any modifications to its products, deemed necessary or useful in order to improve them without impairing their basic characteristics.

Total or partial reproduction of the products is prohibited in Italy and abroad.

Компания "Tonin Casa divisione della Progetto Design International s.r.l." оставляет за собой право изменять в любое время и без предварительного уведомления, технические характеристики элементов, используемых в этом каталоге.

Некоторые аксессуары, представленные на фотографиях, не производятся фирмой "Tonin Casa divisione della Progetto Design International s.r.l." Пожалуйста, обратитесь к прайс-листу.

Компания "Tonin Casa divisione della Progetto Design International s.r.l." также оставляет за собой право вносить в наши собственные продукты те изменения, которые вы считаете необходимым или полезным для того, чтобы улучшить их без ущерба для их основные характеристики.

Запрещается полное или предвзятое воспроизводство в Италии и за рубежом.

progetto  
design



**Tonin Casa**  
divisione della  
Progetto Design International srl

via Palladio, 43  
35010, San Giorgio in Bosco (PD), Italy

t +39 049 9453300  
f +39 049 9450725

info@tonincasa.it  
c.f. P.iva IT03817150240