

SPXDBTC

Bluetooth Dynamic RGB Controller

Once the whip or LED strip lights are installed as per the **SPXDW4 / SPXD5** instructions, install the app.

GET THE APP

Scan the QR Code, or visit Google Play or iTunes to download the *Stinger Lighting* app. Once the app is installed, power up the RGB Module and open the app. The module should auto-connect and be listed in the device list. And Jon says Let There Be Light.



SCAN for Apple iOS and Android App

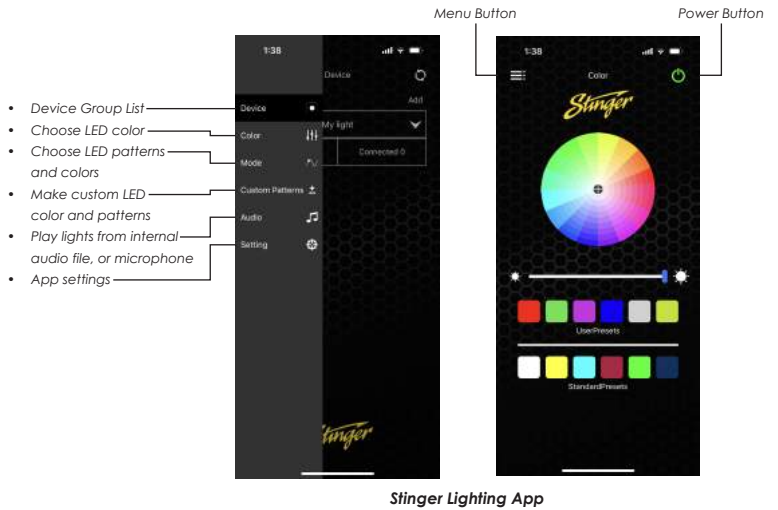

RF Dynamic RGB Controller

Once the whip is installed as per the SPXDW4 / SPXD5 instructions, remove the clear plastic battery shield from the remote.

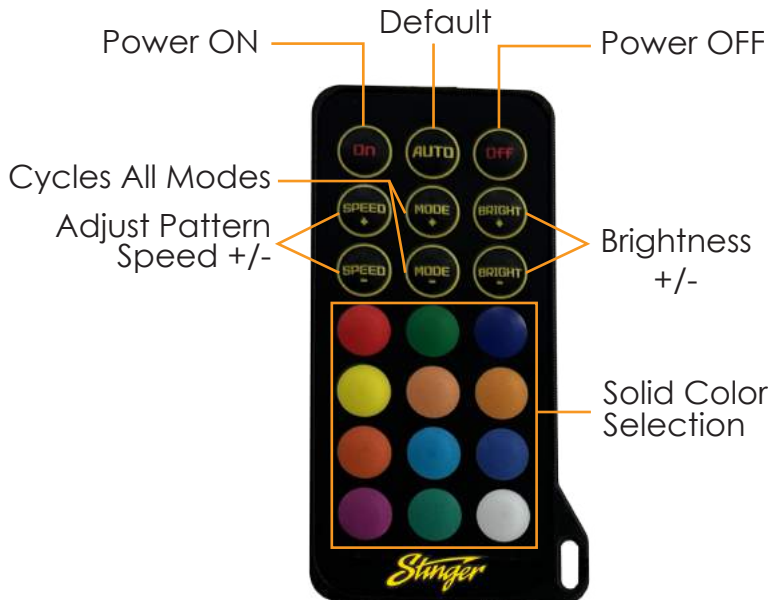

WIRING DIAGRAMS

Diagram 1: Wiring direct to power and using an App to turn on/off. Must add 3 AMP fuse on RED 12V+ wire.

Diagram 2: Wiring with a switch. You can add a new dedicated switch or use an existing light switch that outputs 12V+ when ON. You will need to add a 3 AMP fuse on the RED 12V+ wire and also requires a 12V relay. Note: When wired to a switch, the RGB controller will default to last mode/color used. No need to access the app.

HEIGH10 connection: Connect the Sirius XM harness to the HEIGH10 Radio Module, then connect the 4 pin male connector of the LED module to the female connector of the HEIGH10 Sirius XM harness.

If your HEIGH10 is missing the harness or has the wrong connector you will need to purchase the optional harness (**SE-SXMHAR**)

NOTE: Lighting module will still need separate power and ground when connecting SE-SXMHAR

SPXDUBKIT

Diagram 1

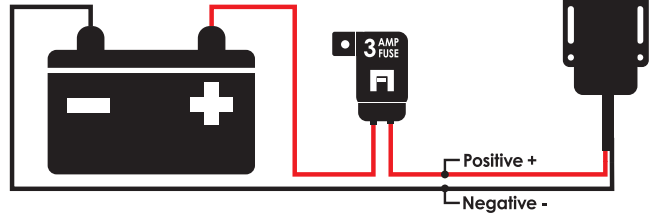
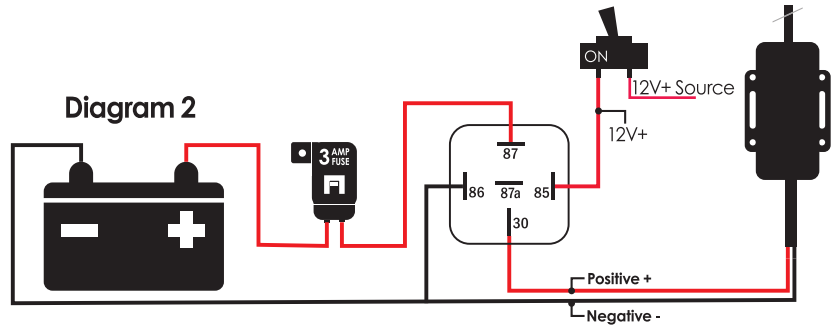
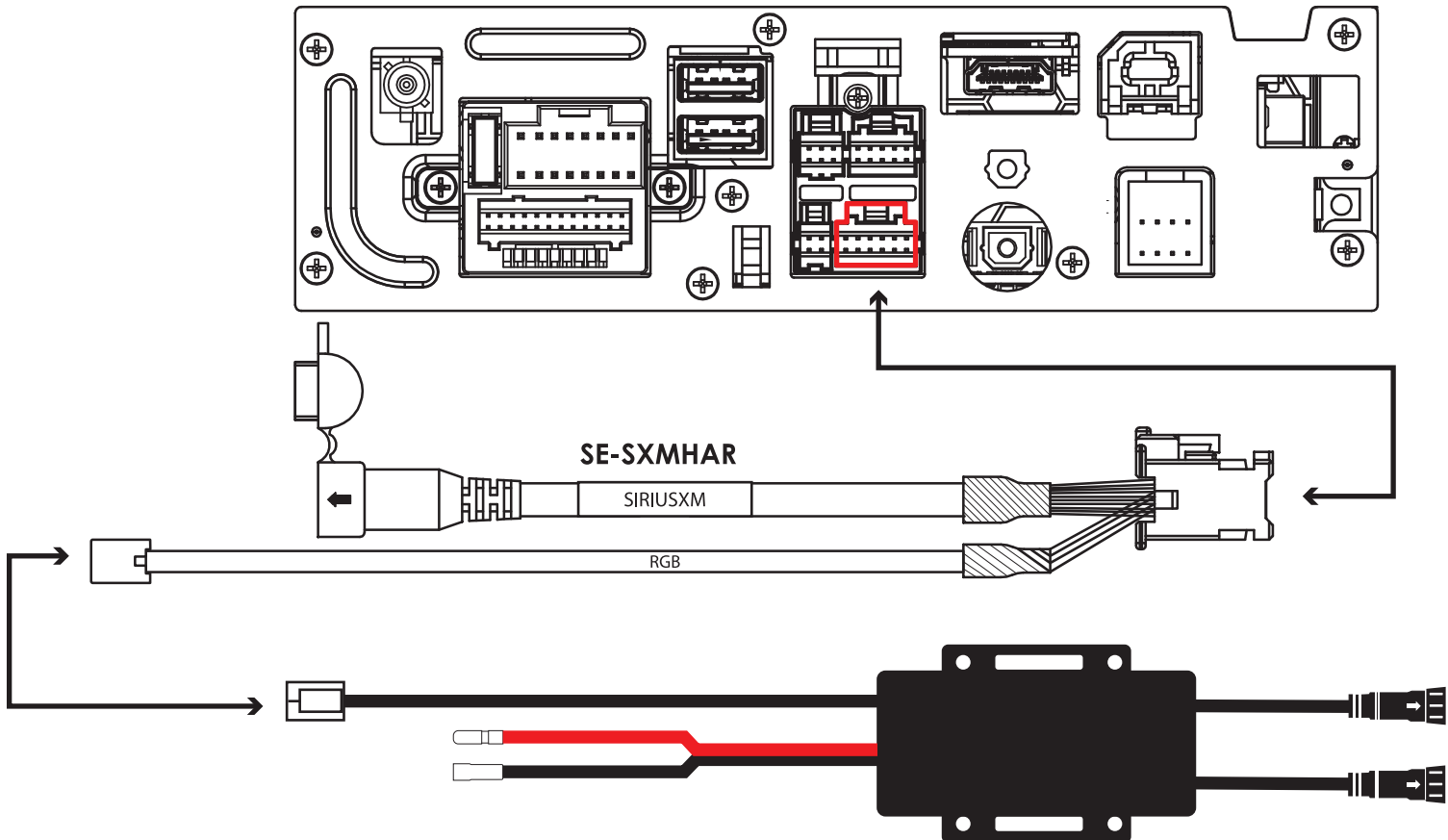

Diagram 2



Radio Module



When adding multiple light kits together you will need to adjust the pixel count using the enLIGHT10 phone app.

Below are the pixel count for each part and on page 2 you will find the Steps and the Pixel Calculator.

Each SPXDBTC has a pixel count min and max

Minimum 30

Maximum 1024

Rock Lights = 4 pixels per Rock Light

For example:

1 SPXDK4 (4 Rock Lights) = 16 pixels. **(App supports min 30 pixels)**

1 SPXDK8 (8 Rock Lights) = 32 pixels.

Whips and Light Strips are treated as left/right pairs so pixel count is for two units.

For example:

2 SPXDW4 (Whips) = 108 Pixels total.

2 SPXD5 (Light Strips) = 100 pixels total.

If you were to have three or four Whips you would enter $108 \times 2 = 216$ pixels.

If you were to have three or four Light Strips you would enter $100 \times 2 = 200$ pixels.

Product Pixel Count:

SPXDK4

4 Rock Light Kit = 16 pixels

App is preset to 30 pixels



SPXDK8

8 Rock Light Kit = 32 pixels

App is preset to 32 pixels



SPXDE4

4 Add on Rock Lights = 16 pixels

Add 16 pixels for each kit



SPXD5

5 Meter LED Strip = 100 pixels

Add 100 pixels for one or two strips



SPXDUBKIT

6 LED Light Strip Kit = 50 pixels

App is preset to 50 pixels



SPXDW4

4ft Whip = 108 pixels

Set App to 108 pixels for one or two Whips



Step 1.

Open the enLIGHT10 app on your phone.

Step 2.

Open the **Settings** menu.

Step 3.

Click on **Chasing Setting**.

Step 4.

Click on **the device**.

The device should now be highlighted in blue.

If you have a kit the device name will have a preset pixel count (SPXDK4 = 30, SPXDK8 =32, SPXDUBKIT = 50).

Step 5.

Enter the number of pixels you want and press enter.

Step 6.

Go to the Mode page and turn the connected device off then on by pressing the Green icon.

Pixel Calculator

Rock Light = 4 pixels each

LED strip per 2 inches = 1 pixel

For example:

12 Inch strip = 6 pixels

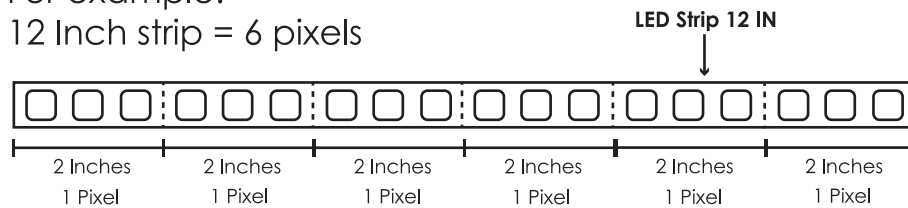

2

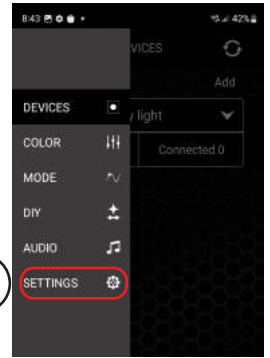

3



4

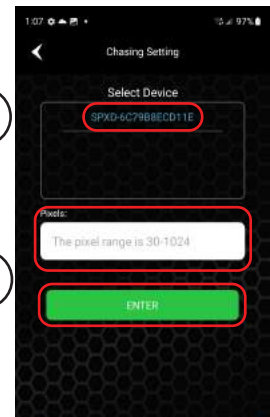

5

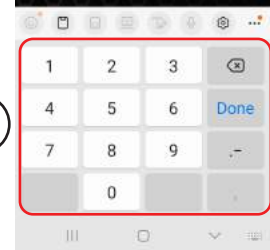

5

6

