



MADE IN THE USA

INSTALLATION MANUAL

BRONCO STEP SLIDER 4 DOOR

2021-PRESENT

BD-SS-300-BR4

BD-SS-300-BR2



Step Sliders for the New Ford Bronco

Description	Quantity
Electric Step Slider (Pair)	2
Wiring harness	1
Double sided adhesive strips	4
Door sensor	4
Magnets	4
Magnet Mount	2 - 2 Door 4 - 4 Door
Thin VHB - Magnet Kit	2 - 2 Door 4 - 4 Door
Thick VHB - Sensor & Magnet Kit	6 - 2 Door 12 - 4 Door
Alcohol wipes - Sensor & Magnet Kit	5
Rocker cutoff switch	1
Black spacer plate	2
1/4" push in plug	8
M10 flange bolt	10
5/16" - 18 nylock nut (pinch seam)	8
5/16" grade 8 washer (pinch seam)	8
1/4" - 20 nylock nut (pinch seam)	4
1/4" - 20 grade 8 washer (pinch seam)	4
5/16" - 18 X 1" grade 8 hex head bolt	40
5/16" SAE yellow zinc washer	40
18-8 Button head hex drive screws	2
Front bracket (long style)	2
Second bracket (straight edge drop style)	2
Middle twin brackets (drop style)	4
Rear Bracket (straight edge drop style)	2
Rocker cutoff switch bracket	1
Floor Plug Grommet	2
Tip Tie	10
Rubber Trim	2

Front Bracket



Long Style

Second Bracket



Drop Style
Straight

Middle Twin Brackets



Drop Style

Rear Brackets



Drop Style
Straight,
Middle Bolt
Cutout

Tools Required	
10 mm socket	7/16" socket
18 mm socket	1/2" socket
8 mm socket	Wrench with 3-4" extension
Breaker bar	1/2" Box end ratcheting wrench
7/16" Box end ratcheting wrench	
**Optional for quicker install	
Impact Gun with adapters	Heavy Duty Impact Gun with 1/2" driver

Notes and Maintenance

Before you begin installation, read all instructions thoroughly.

Proper tools will improve the quality of installation and reduce the time required.

No maintenance required on waterproof harness or water-resistant motors. If mud or dirt is built up on the steps, simply spray them off and let them air dry.

Mild automotive detergent may be used to clean the product. Do not use dish detergent, abrasive cleaners, abrasive pads, wire brushes or other similar products that may damage the finish.

Periodic inspection of all wires and connections should be performed to ensure there is no visible damage or loose connections.

Refer to the last page of this manual for troubleshooting, warranty and product registration information.

Harness Diagram - 1

- A. CIRCUIT BOARD CONNECTOR
- B. MOTOR CONNECTOR
- C. LIGHT CONNECTOR
- D. REAR DOOR SENSOR CONNECTOR
- E. FRONT DOOR SENSOR CONNECTOR
- F. ROCKER SWITCH CONNECTORS
- G. ROCKER SWITCH
- H. BATTERY TERMINALS
- I. FUSE HOLDER

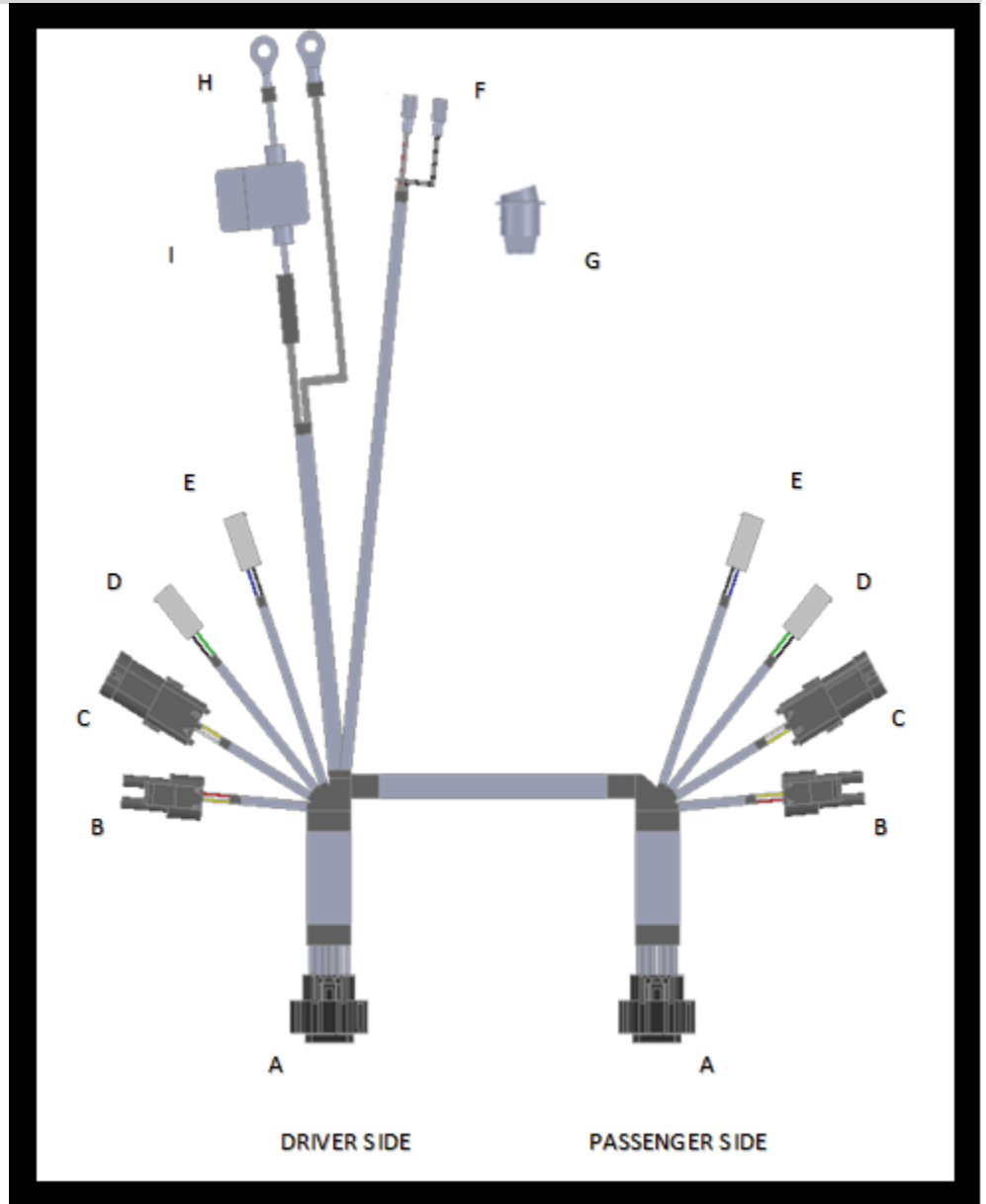
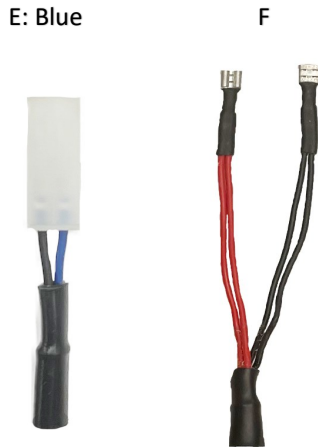
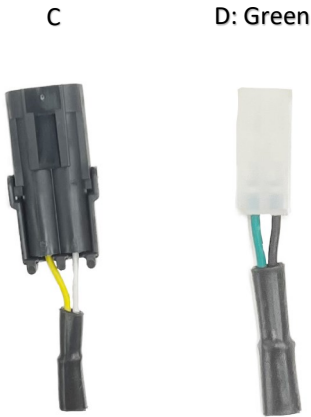

Harness Route: Driver Side

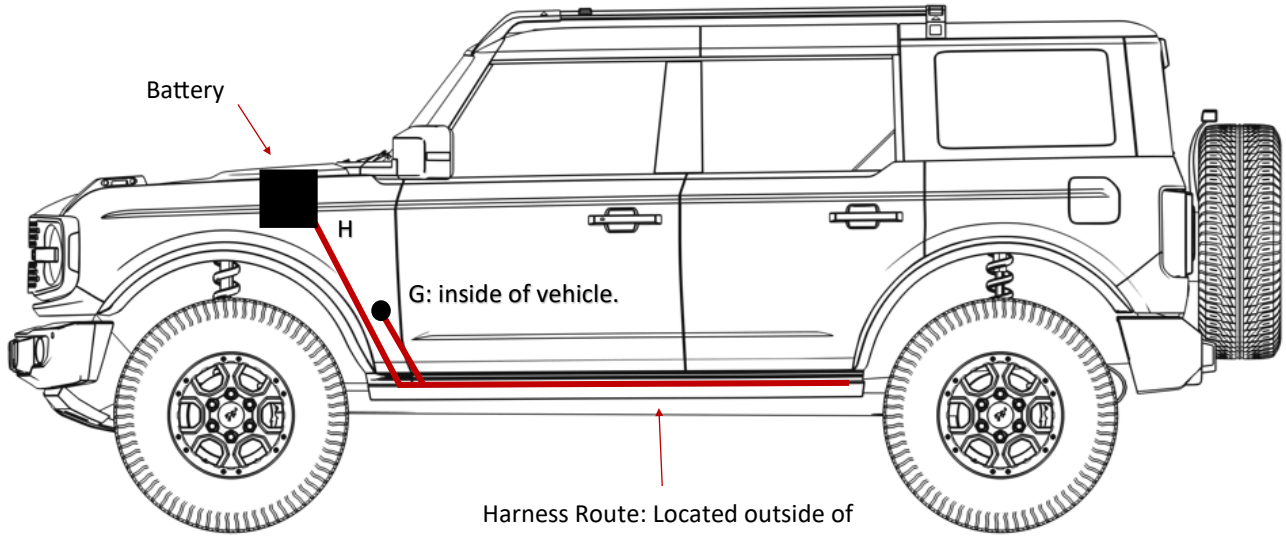

Harness Route: Located outside of the Bronco attached to the top of the frame rail.

Harness Route: Passenger Side

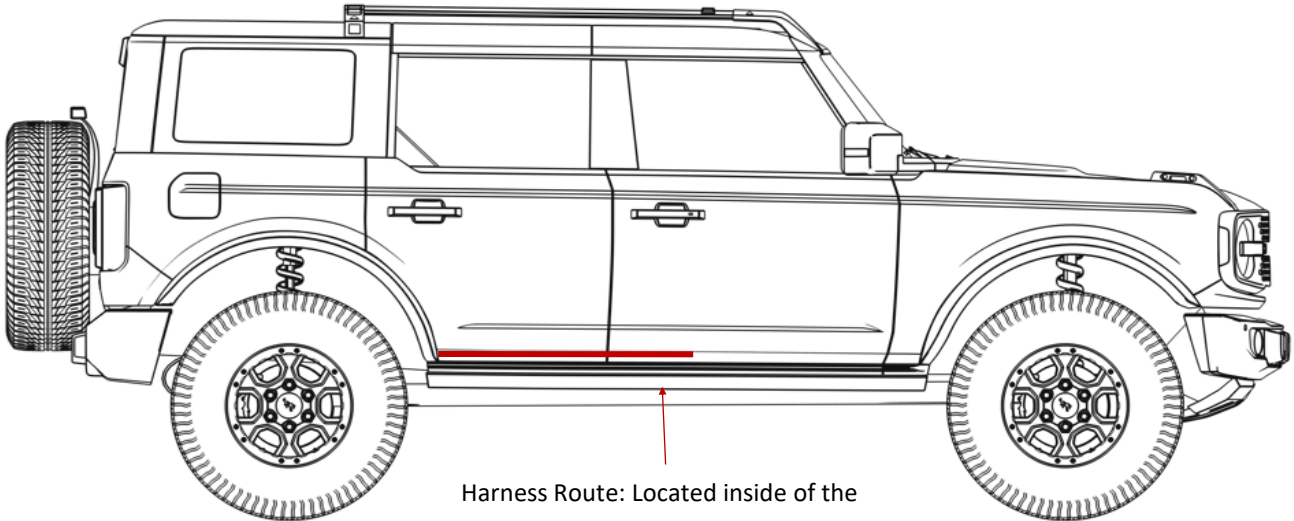

Harness Route: Located inside of the vehicle underneath the plastic rocker panels.

IMPORTANT
BRONCO SPORT: Model is not compatible with RSE Step sliders.

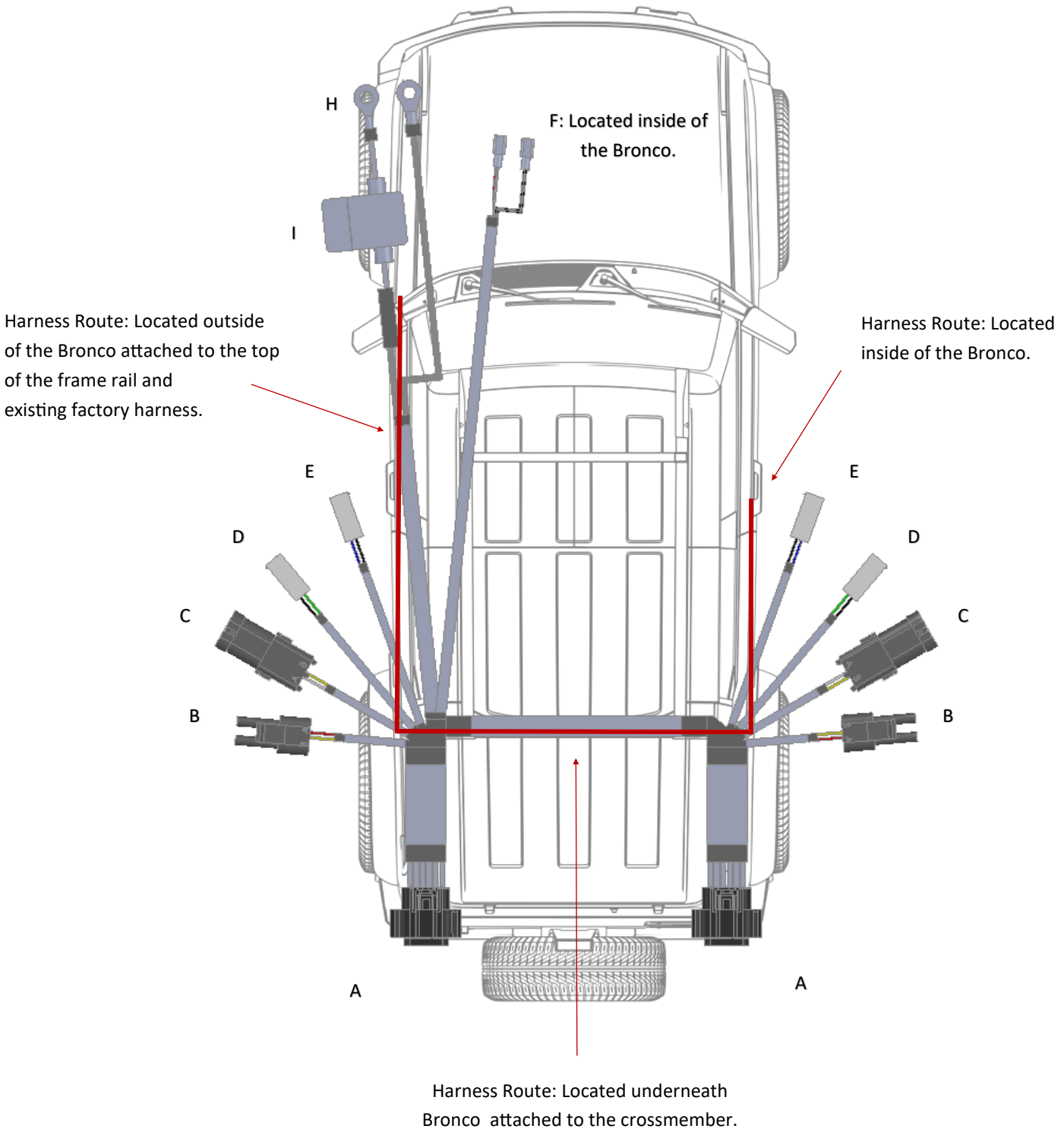

Step 1

REMOVE THE FUSE FROM THE HARNESS

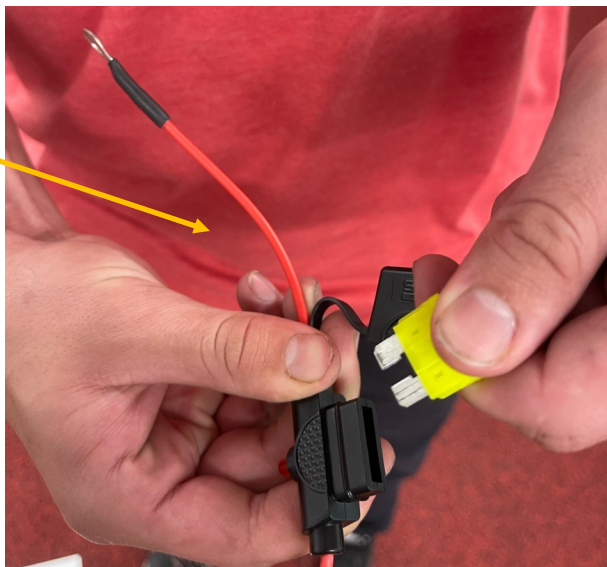

INSTALLING THE DRIVER SIDE OF THE HARNESS

Once the fuse is removed: trace the driver side of the harness with the fuse case, red wire (+) and black wire (-) from the rear driver side door along the frame rail. Fasten the first junction of wires to the existing factory harness with a zip tie. Leaving the remainder of the harness at the driver door free.

Continue to secure the harness with more zip ties. One should be located directly behind the first body bolt. Do not tighten completely until full harness is in place.

Passenger Side Harness Zip Tie Anchor Points

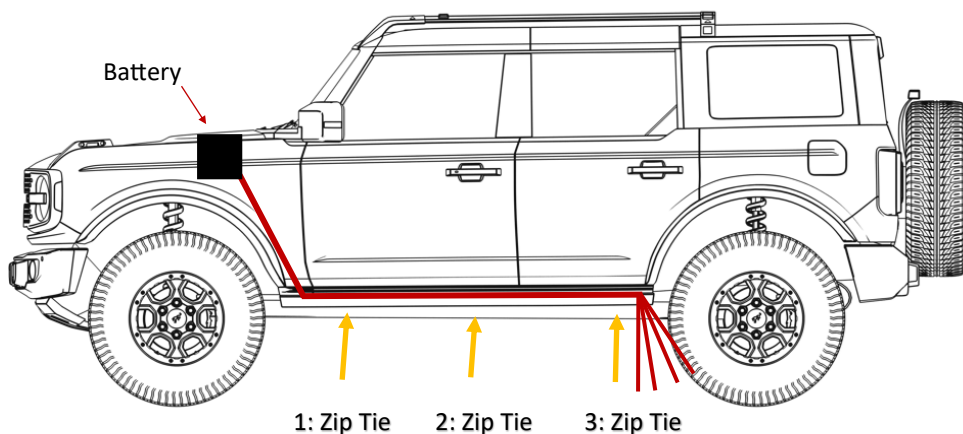

RSE Harness

Factory Harness

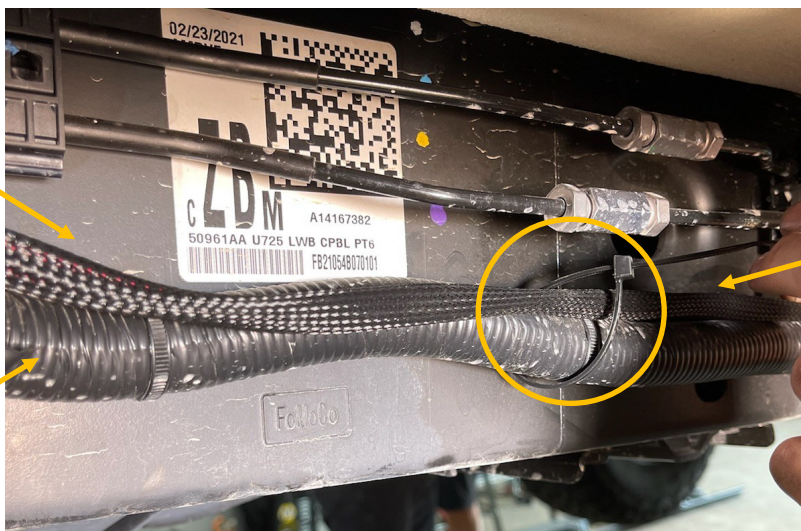

Zip Tie

Step 2

CONNECTING TO THE BATTERY TERMINAL

ENSURE THE FUSE IS PULLED FROM THE WIRING HARNESS

Run the red wire (+) and black wire (-) with the fuse case along the frame rail behind the first body bolt. Pulling it through to the wheel well.

Tucking the harness behind the fuse box. Attach the red wire (+) to the positive terminal. The black wire (-) will attach to the negative terminal.. Ensure it has good metal to metal contact to keep paint from interfering with the connection.



IMPORTANT

You must attach the ground wire to the body bolt. If you don't, you will lose 6 inches of harness length.

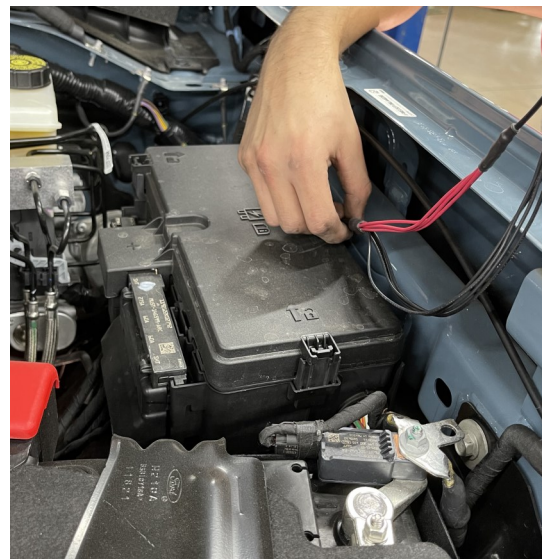
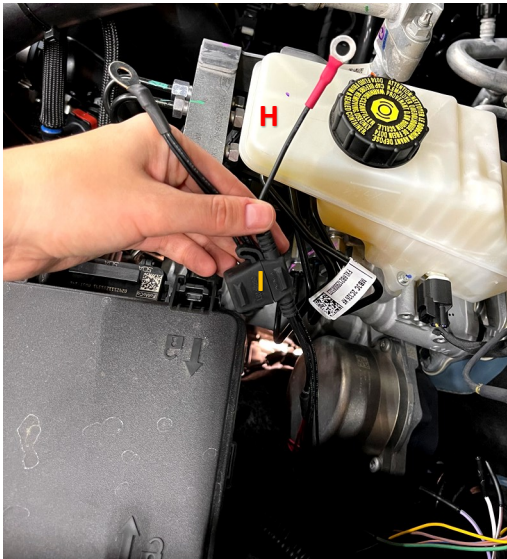

Step 3

REMOVE THE FLOOR DRAIN PLUG

Take off the middle rocker panels on the rear driver side door of your Bronco. Peel up the carpet to expose the floor drain plug and remove to continue your harness installation. Repeat this step on the passenger side.

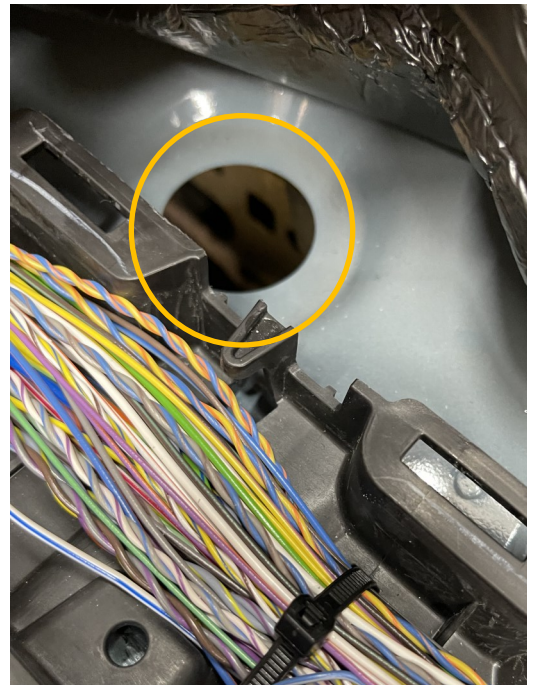

Step 4

Make a small cut on your black grommet. Thread your rocker switch connectors (F) and both door sensor connectors (D & E) through. Pull them over the frame rail and install from underneath the Bronco into the cab. Pressing the grommet into the floor plug hole. The circuit board (A), motor (B) and light (C) connectors will remain visible on the driver side.

Once your connectors are all in place, continue to run the harness from the driver side to the passenger side over the frame rail. Run it along the cross member and secure the RSE Harness with zip ties to the factory harness. Watch for foil wrapped areas and securing the harness away from anything that might expose the harness to too much heat.

Repeat this step on the passenger side of the vehicle with the other two door sensors.

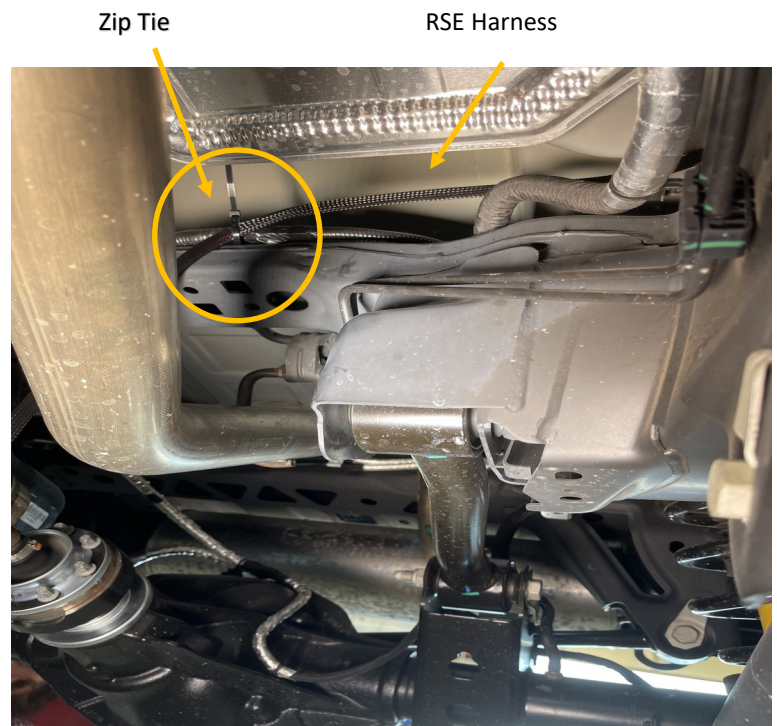
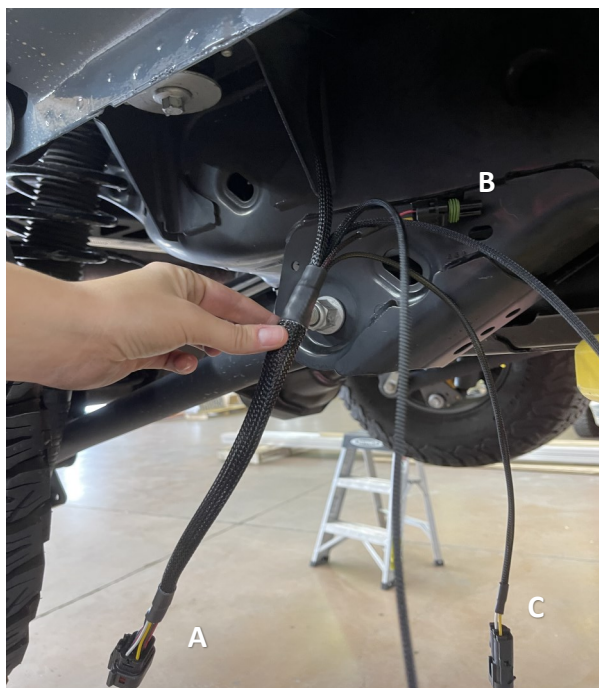
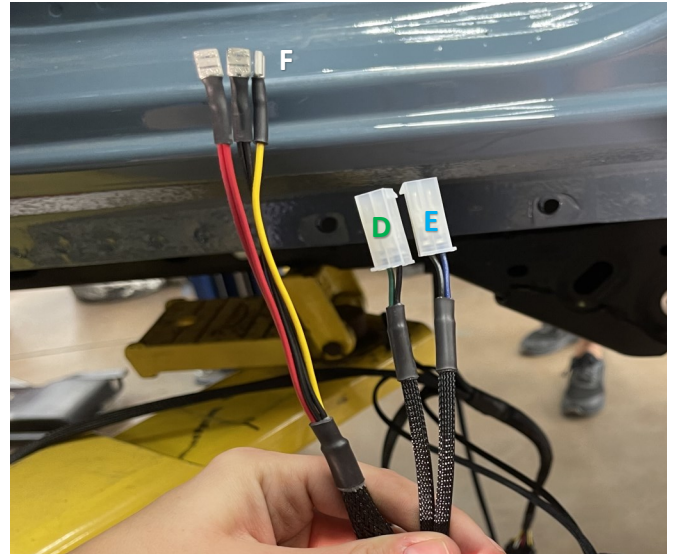

Step 5

INSTALLING THE HARNESS INSIDE OF THE BRONCO

Leave the middle rocker panels off and the green door sensor (D) in the back. Run the front blue door sensor (E) and the Rocker Switch (F) along the existing harness towards the front of the Bronco. Press the carpet down to tuck the underneath the plastic panels that are left in place.

Repeat this step on the passenger side of the vehicle with your door sensors.

In the front, you may have a foot rest. DO NOT TRY TO PULL IT OFF. Tuck the harness underneath it by pressing in the carpet. Consider using plastic pry tools to gently lift the plastic and press the carpet down. Removing all of the rocker panels is not necessary.

Rear Driver door



Front Driver door



Step 6

INSTALLING THE ROCKER SWITCH

Lower the steering column panel to expose the bolt where your rocker switch bracket will attach. Using a 10 mm socket, remove the factory bolt and re-use it to secure the bracket.

Pull the wires through the bracket.

Plug red and black wires into the two prong switch. The wires can be plugged in on either side. Push the button back into the bracket until it snaps into place.

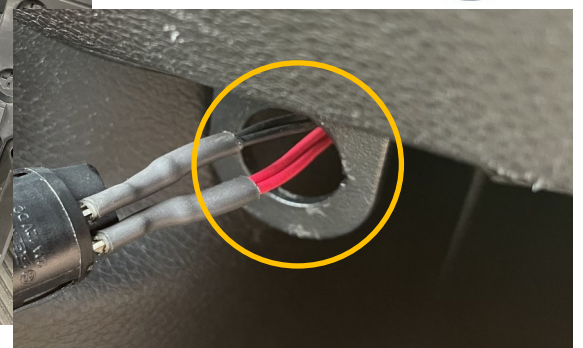

Step 7

RUBBER TRIM INSTALLATION

Before you install the step slider, you need to install the rubber trim on both sides.

Place the rubber trim at the endcap of your step. Press it to the inner edge of the step slider. The trim may stretch, cut if necessary to fit between both endcaps.



IMPORTANT

DO NOT SKIP THIS STEP.
The rubber trim protects the side of your vehicle.

Step 8

MECHANICAL INSTALLATION OF THE STEP SLIDERS

With the harness installed, tighten up your zip ties and secure the harness into place. Making sure there are no parts of the harness hanging below the body.

Remove these factory brackets on the middle and rear of the Bronco, along with these pinch seam bolts.

IMPORTANT

Keep your pinch seam bolts. You will re-use them to install the spacer plate.

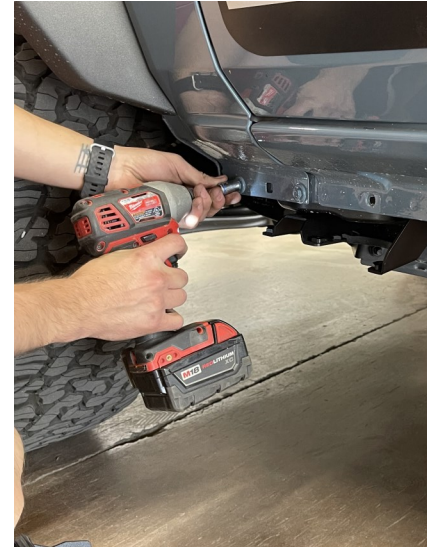

Step 9

Starting on the driver side, locate the two body bolts on the underside of the vehicle. Loosen the two body bolts about 1/4" to allow free movement of the washer up and down. It should only move enough to slide your brackets into place. Repeat this step on the passenger side.

Breaker may be required to loosen body bolts.

TIP FROM A MECHANIC

As you start loosening, as soon as you hear the bolt pop or feel it bind, reverse direction 1/8 to 1/4 turn to clear the threads. This will make it easier as you progress. Even if you do not hear it pop do the reverse direction early on to prevent body bolt damage.

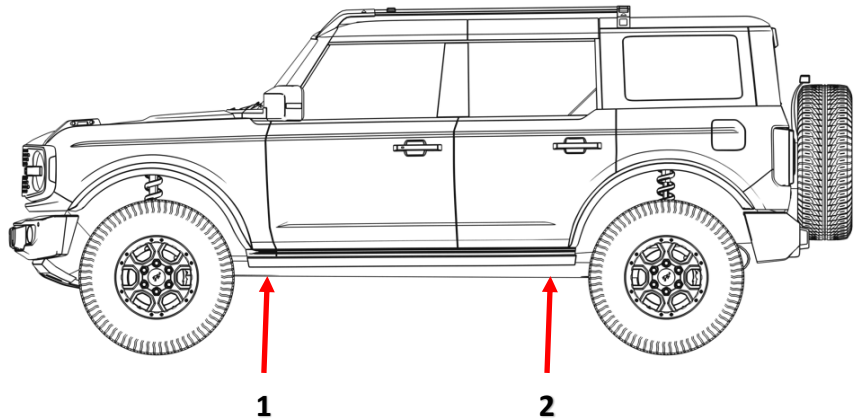

IMPORTANT

RSE is not responsible for any body bolt damage. Please visit your Ford dealership or regular mechanic for assistance.

Step 10

Install your spacer plate using one black hex screw and one of the factory seam bolts you removed from the vehicle.

The angle of the spacer plate should be closest to the engine bay.



Driver Side

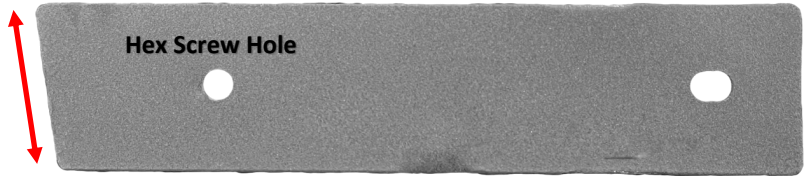

Passenger Side

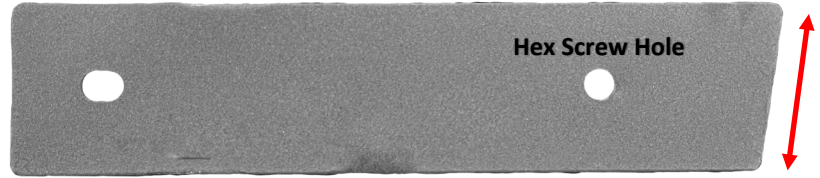

Step 11

Install each bracket:

1. Fits on the front body bolt.
2. Two seam bolts behind the front bracket.
3. Replaces the first factory bracket that was removed. Install with two 10 mm bolts.
4. Replaces the second factory bracket that was removed. Install with two 10 mm bolts.
5. Fits on the rear body bolt.

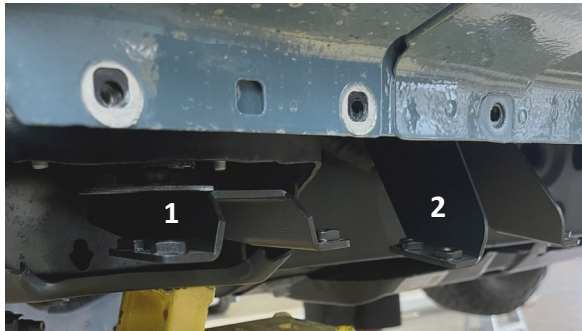

1. Front Bracket



Long Style

2. Second Bracket



Drop Style
Straight

3 & 4. Middle Twin Brackets



Drop Style

5. Rear Brackets



Step 12

STEP SLIDER INSTALLATION

Before placing your step slider on the Bronco, pull the circuit board (A) and motor connector (B) through the last cutout between the last bolt and the step slider bracket mounting hole. This will make it easy to find your wires and plug in.

When you have the bolts on the step slider inserted into the pinch seam holes, the Step Slider will stay on the Bronco by itself. Secure the Step Slider to the seam by using a 1/4 and 5/16 nyloc nut washer sets.

Plug the circuit board (A) and motor connector (B) into their ports. The additional wire on the harness is for the optional light kit connector (C). Tuck away inside of the step slider for later installation.

Now tighten the pinch seam nuts. 1/4 in. nuts torque 8 ft. lbs. 5/16 nuts torque to 18 ft. lbs.

Next, tighten the body bolts. Torque these to 80 ft. lbs.

Repeat this process on both sides.

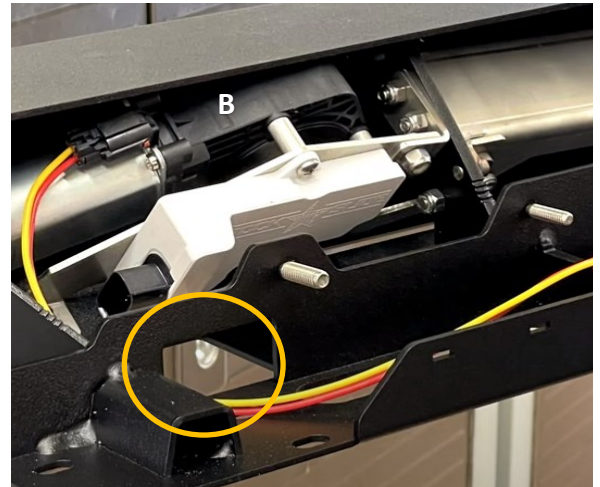
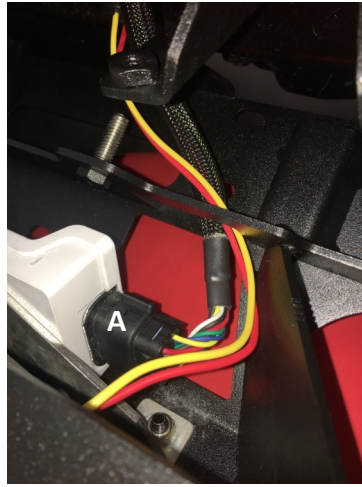

IMPORTANT

Make sure your wires are not being pinched between the brackets, Step Slider or body of the Bronco.

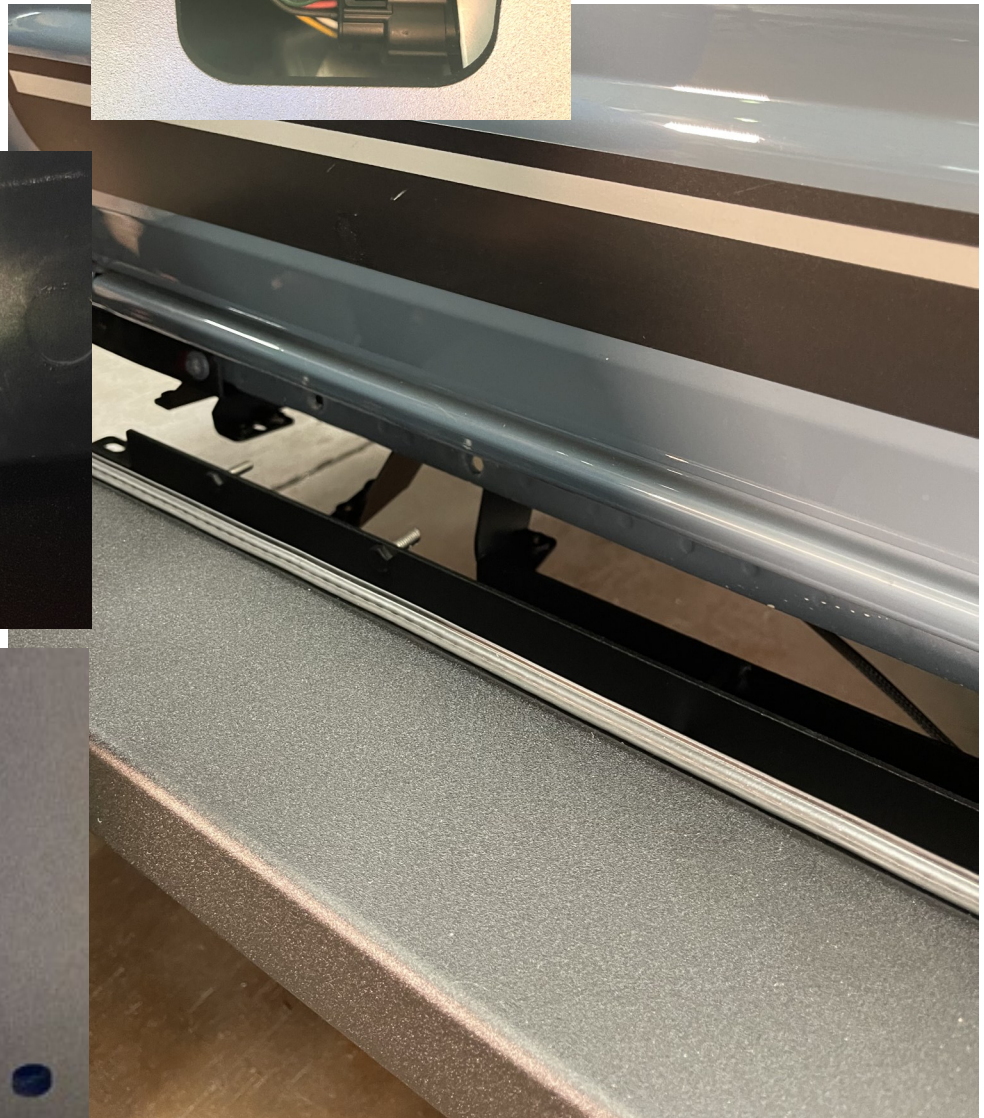

Step 13 - Pt. 1 Driver Side Front Door

FRONT DRIVER SIDE SENSOR & MAGNET INSTALLATION

Using the alcohol pad, clean the exposed pinch seam on the far right hand side and the back of your sensor. Place the adhesive backing onto the sensor and tuck the right hand corner under the rocker panel plastic. Lining up the bottom of the sensor holes with the top of the seam.

Expose the adhesive on the foam wire protector next to the sensor and wrap it along the frame metal to secure it into place. Connect the door sensor to the blue wire (E) connector. Tuck the connector inside of the rocker panel and replace the plastic. If the rocker guard won't pop back into place, move the sensor forward, further underneath the plastic.

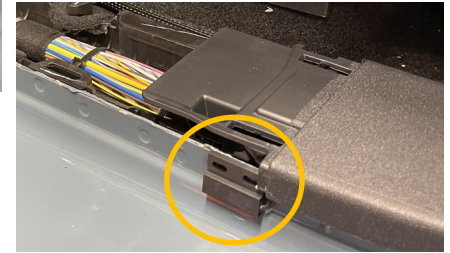
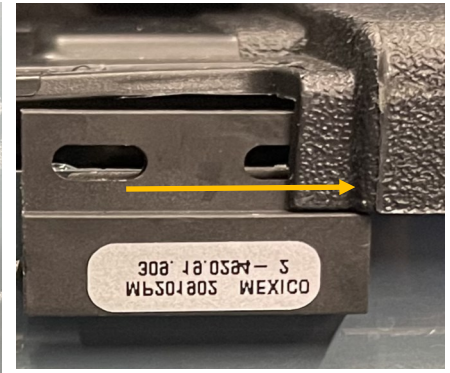

MAGNET MOUNT ASSEMBLY

1. Remove the yellow backing from the thin black VHB tape and adhere it to the front cutout of the magnet mount.
2. Clean your magnet with the alcohol pad before securing to the VHB.
3. Flip the mount to the back and use two strips of the thick VHB tape to secure your mount to the Bronco. Leave the backing in place until test fit is complete.

IMPORTANT

Do a test fit to make sure the magnet is properly aligned with the door sensor BEFORE securing the mount onto the Bronco with the VHB.

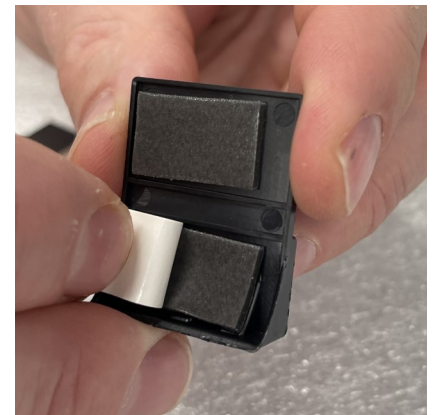
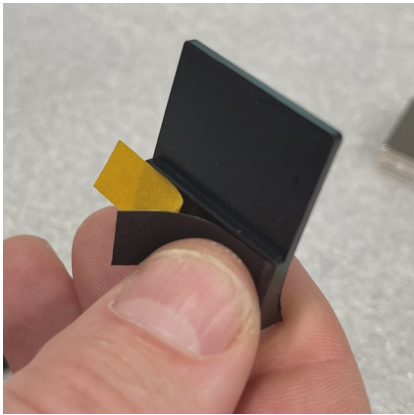

IMPORTANT

Only connect one door at a time. Plug your fuse in and make sure the magnet is in the correct location. If it is, the step will deploy when you open the door and retract when you close it. Once you know one door is working, remove the fuse and move onto the next door. If the step does not deploy, you may need to adjust the location of your magnet.

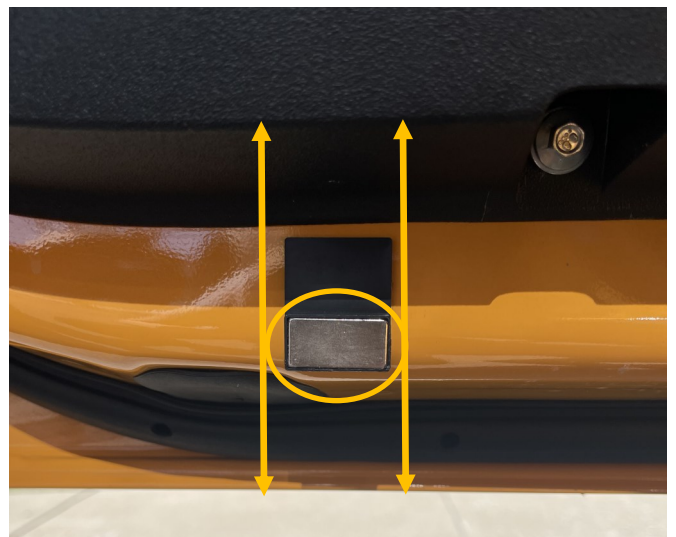

Step 13 - Pt. 2 Driver Side Rear Door

REAR DRIVER SIDE SENSOR & MAGNET INSTALLATION

Using the alcohol pad, clean the exposed pinch seam on the far left hand side and the back of your sensor. Place the adhesive backing onto the sensor and tuck the left hand corner under the rocker panel plastic. Lining up the bottom of the sensor holes with the top of the seam.

Expose the adhesive on the foam wire protector next to the sensor and wrap it along the frame metal to secure it into place. Connect the door sensor to the green wire (D) connector. Tuck the connector inside of the rocker panel and replace the plastic. If the rocker guard won't pop back into place, move the sensor forward, further underneath the plastic.

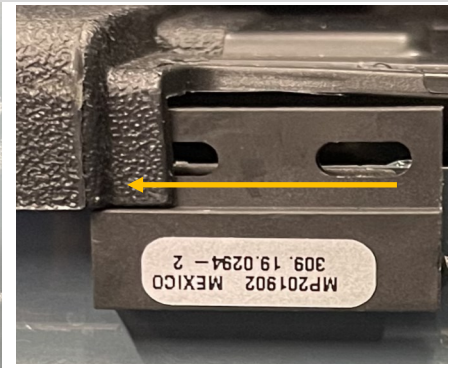

MAGNET MOUNT ASSEMBLY

1. Remove the yellow backing from the thin black VHB tape and adhere it to the front cutout of the magnet mount.
2. Clean your magnet with the alcohol pad before securing to the VHB.
3. Flip the mount to the back and use two strips of the thick VHB tape to secure your mount to the Bronco. Leave the backing in place until test fit is complete.

IMPORTANT

Do a test fit to make sure the magnet is properly aligned with the door sensor BEFORE securing the mount onto the Bronco with the VHB.

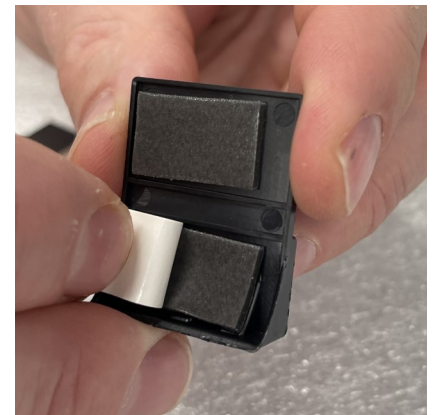
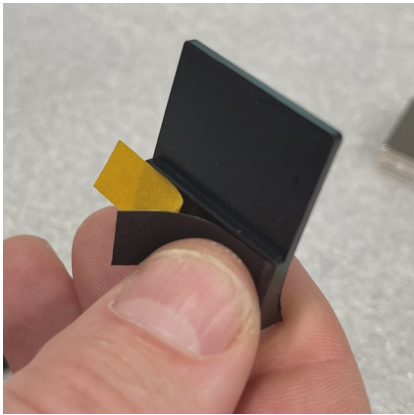

IMPORTANT

Only connect one door at a time. Plug your fuse in and make sure the magnet is in the correct location. If it is, the step will deploy when you open the door and retract when you close it. Once you know one door is working, remove the fuse and move onto the next door. If the step does not deploy, you may need to adjust the location of your magnet.

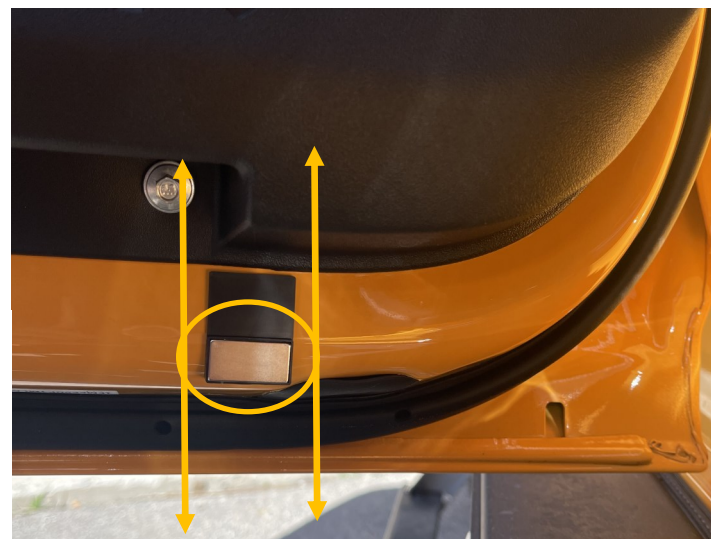

Step 13 - Pt. 3 Passenger Side Front Door

FRONT PASSENGER SIDE SENSOR & MAGNET INSTALLATION

Using the alcohol pad, clean the exposed pinch seam on the far left hand side and the back of your sensor. Place the adhesive backing onto the sensor and tuck the left hand corner under the rocker panel plastic. Lining up the bottom of the sensor holes with the top of the seam.

Expose the adhesive on the foam wire protector next to the sensor and wrap it along the frame metal to secure it into place. Connect the door sensor to the blue wire (E) connector. Tuck the connector inside of the rocker panel and replace the plastic. If the rocker guard won't pop back into place, move the sensor forward, further underneath the plastic.

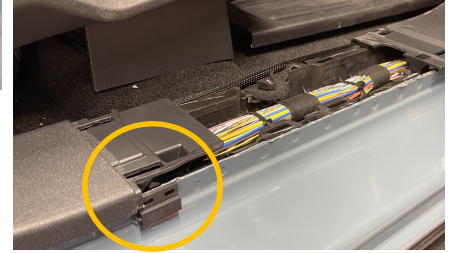
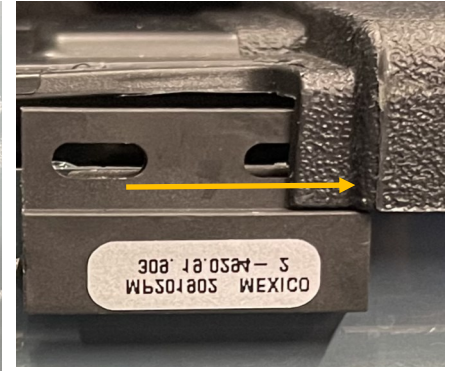

MAGNET MOUNT ASSEMBLY

1. Remove the yellow backing from the thin black VHB tape and adhere it to the front cutout of the magnet mount.
2. Clean your magnet with the alcohol pad before securing to the VHB.
3. Flip the mount to the back and use two strips of the thick VHB tape to secure your mount to the Bronco. Leave the backing in place until test fit is complete.

IMPORTANT

Do a test fit to make sure the magnet is properly aligned with the door sensor BEFORE securing the mount onto the Bronco with the VHB.

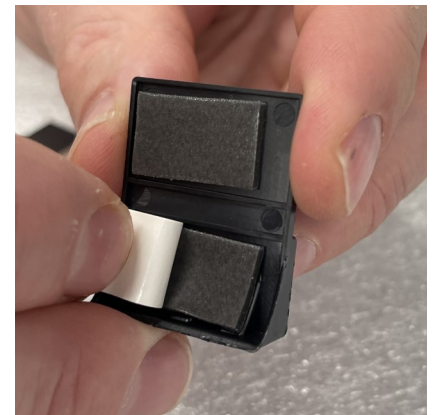
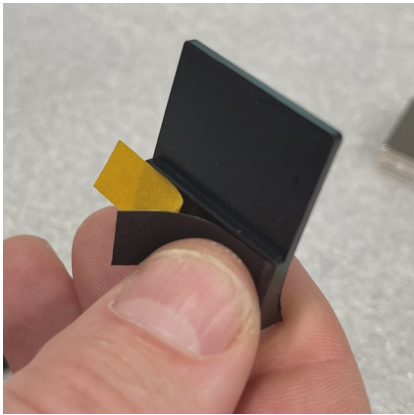

IMPORTANT

Only connect one door at a time. Plug your fuse in and make sure the magnet is in the correct location. If it is, the step will deploy when you open the door and retract when you close it. Once you know one door is working, remove the fuse and move onto the next door. If the step does not deploy, you may need to adjust the location of your magnet.

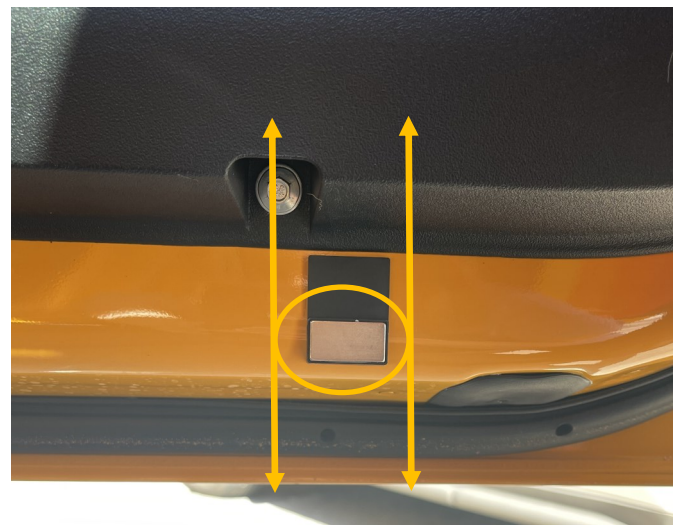

Step 13 - Pt. 4 Passenger Side Rear Door

REAR PASSENGER SIDE SENSOR & MAGNET INSTALLATION

Using the alcohol pad, clean the exposed pinch seam on the far right hand side and the back of your sensor. Place the adhesive backing onto the sensor and tuck the right hand corner under the rocker panel plastic. Lining up the bottom of the sensor holes with the top of the seam.

Expose the adhesive on the foam wire protector next to the sensor and wrap it along the frame metal to secure it into place. Connect the door sensor to the green wire (D) connector. Tuck the connector inside of the rocker panel and replace the plastic. If the rocker guard won't pop back into place, move the sensor forward, further underneath the plastic.

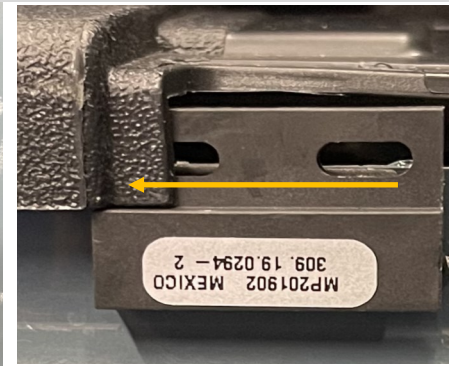

MAGNET MOUNT ASSEMBLY

1. Remove the yellow backing from the thin black VHB tape and adhere it to the front cutout of the magnet mount.
2. Clean your magnet with the alcohol pad before securing to the VHB.
3. Flip the mount to the back and use two strips of the thick VHB tape to secure your mount to the Bronco. Leave the backing in place until test fit is complete.

IMPORTANT

Do a test fit to make sure the magnet is properly aligned with the door sensor BEFORE securing the mount onto the Bronco with the VHB.

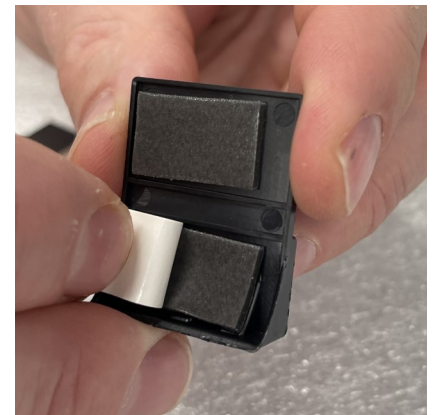
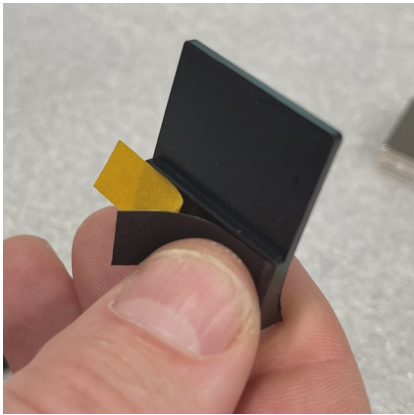

IMPORTANT

Only connect one door at a time. Plug your fuse in and make sure the magnet is in the correct location. If it is, the step will deploy when you open the door and retract when you close it. Once you know one door is working, remove the fuse and move onto the next door. If the step does not deploy, you may need to adjust the location of your magnet.

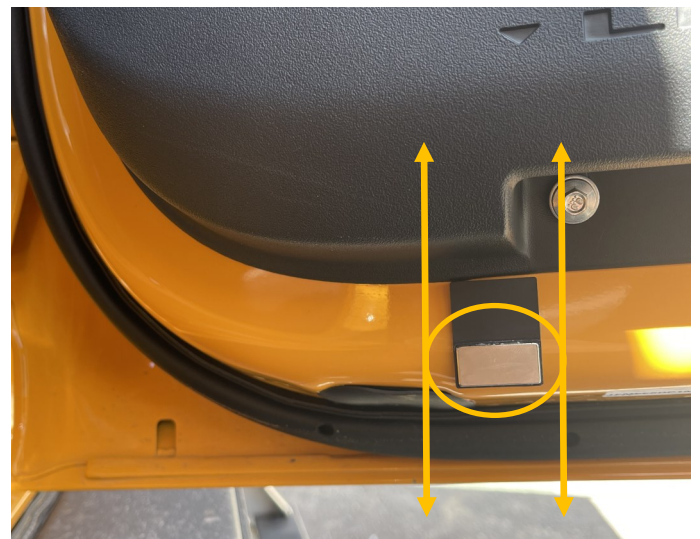

Step 14

CALIBRATION CYCLE

With both of your step sliders installed, it is time to let the circuit board calibrate.

Reinstall the fuse. When you do this, the steps will deploy and retract rapidly. This is normal.

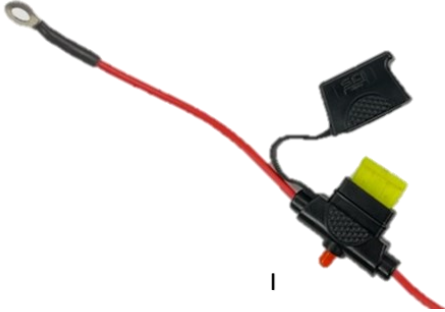

IMPORTANT

Make sure there is nothing that will stop the step from deploying and retracting fully. If something has blocked your step, remove the fuse again and re-run the calibration cycle.

Step 15

Use these plugs to cover the holes in the Step Slider.



You are done!

Scan this code to leave us a review!



See our FAQ on the next page for any troubleshooting or give us a call!



FREQUENTLY ASKED QUESTIONS:

<p>I just installed my steps and they are not coming down when I open the door.</p>	<p>Double check the connections. Check the fuse to make sure it is plugged in. Is the on / off switch getting power? Is the circuit board plugged in? Are the door sensors plugged in?</p>
<p>My rocker switch is getting power, but the light stays on in both positions.</p>	<p>The light is only supposed to be on when the system is turned on. If it is lit in both positions simply switch the red wires on the back. Will this kill my battery with the light constantly lit? This will not kill your battery unless you leave it lit for a month with no use.</p>
<p>Everything is plugged in and the switch is turning on and off, but the steps still won't deploy.</p>	<p>Check the motor first. Simply unplug it from the wiring harness and apply external 12V power to the leads. One position will make them deploy. Switch the leads again to make them retract. If this works, plug the motor back into the harness. We test each and every motor that leaves our factory by hand along with assembling your step slider by hand. These may fail, but it is extremely rare after we send them after having tested them. If you test the motor and all you hear is a clicking sound but nothing happens, there is likely internal damage.</p>
<p>I tested the motor, and it works. I checked the sensors individually, and the system still won't work. The steps don't deploy unless I do it manually with 12V power.</p>	<p>In rare circumstances, the circuit board that runs the system may be faulty. Send us an email at Warranty@rockslideengineering.com to request a new circuit board.</p>
<p>I opened my door a bunch of times and the system just shut off. What happened?</p>	<p>Our systems have built-in protection against quick cycling like this to prevent damage. Simply remove your 20 volt fuse and re-install. This will reset the system and allow it to work normally again.</p>
<p>Everything is working now. But I want to take my doors off and have the steps still work.</p>	<p>We sell a door delete kit you can replace those sensors with. Part# SL-DD-100 comes with everything you need for two doors. If you want to install a delete kit on the rear doors as well, you will need to purchase two kits.</p>
<p>The steps deployed and won't retract. What is going on?</p>	<p>Chances are your magnets are misaligned. To diagnose which door needs to be adjusted, unplug the rear sensors with the front doors closed. If your steps come up, then it was the rear doors that need to be aligned with your magnet. If the step stays down, the front door needs to be aligned. Open your door, shift the magnet in a direction, and shut it again. Repeat until the step comes up when the door is shut. Mark the magnet placement on the front door. Plug the rear door sensor in, shut the rear door and front door, and see if it comes up. If not, the rear door is misaligned (Since we just aligned the front door we know it's the rear door now). Repeat the previous process of opening your door, shifting your magnet, and shutting your door until the step comes up. It may take a few tries.</p> <p>OPTION 2</p> <p>Check the sensors. Unplug both of them from the wiring harness on the side that is not working, and plug one back in. Manually test your sensors by putting a magnet really close (but not touching) to the sensor. Does it make the step retract? When the magnet is away, the step should deploy. If the steps deploy right after installation, more than likely your magnets just need to be aligned. Do this one by one with each sensor by the method above. Install one sensor, test, align the magnet on the door, test, and then mark the position of the magnet so if for some reason they do move out of place you can easily realign them.</p>
<p>I was off-roading, left my system on, someone left the door ajar and I ripped my step off on a rock. What now?</p>	<p>We can replace these parts for you at cost. You will have to remove the step off your vehicle to replace the innards. Call us and we'll figure out what you need exactly! If you prefer us to do the repair we will do that for you! You will have to cover shipping to us and the cost of the parts, but we will ship it back to you (from our warehouse to your house) on our account.</p>

WARRANTY POLICY

LIMITED TWELVE (12) MONTH WARRANTY FOR FINISH AND ELECTRICAL COMPONENTS

Rock-Slide Engineering, LLC (“RSE”) warrants to the original purchaser that (a) the structural and mechanical components of the Step Sliders will be free of defects in material and workmanship for the lifetime of the Step Sliders (the “product”), and (b) the finish (powder coat) and the electrical components (including the motor) will be free of defects in material and workmanship for a period of twelve (12) months from the original date of purchase. This warranty applies only to the original retail purchaser. Warranty is void if product was not purchased directly from R- SE or from an authorized RSE retailer or reseller. This warranty applies only with regard to the product as originally installed to the original vehicle. This warranty does not cover removal or reinstallation of the product.

To exercise this warranty and receive any warranty service, the original purchaser must provide RSE with proof of purchase and date of purchase that is acceptable to RSE, such as a copy of the original purchaser’s purchase receipt. The original purchaser must return the defective product to RSE along with a description of the problem, a copy of the original purchase receipt, the original bill of sale and all contact information (name, address, telephone number and email address). To begin the warranty process, the original purchaser must email RSE’s warranty department. During this warranty term, and upon the original purchaser’s valid exercise of this warranty, RSE shall, at its option, repair or furnish the replacement product in the event the original product is deemed by RSE to be defective. RSE’s sole liability shall be for repairing or replacing the product, but RSE may refund the purchase price at its sole discretion and option. The original purchaser is responsible for prepayment of all shipping and/or transportation charges with respect to the exercise of this warranty. The product may change without notice. In the event of a product change, RSE has no obligation to upgrade or modify any older generation product.

THE WARRANTY SET FORTH HEREIN IS THE ONLY WARRANTY COVERING THE PRODUCT. NO OTHER WARRANTY EXISTS, EXPRESS OR IMPLIED, INCLUDING, WITHOUT LIMITATION, IMPLIED WARRANTIES OF MERCHANTABILITY AND/OR FITNESS FOR A PARTICULAR PURPOSE. No retailer, reseller, dealer, agent, or employee is authorized to make any modifications, extensions, amendments, or additions to this warranty.

This warranty shall be void in its entirety if RSE determines that the product installation was modified, changed, altered, customized or in any way used other than as instructed. Installation of the product without strictly adhering to the installation instructions shall void this warranty. Installation must be on the proper vehicle or warranty is void.

RSE SHALL NOT BE LIABLE FOR SPECIAL, INDIRECT, INCIDENTAL OR CONSEQUENTIAL DAMAGES, UNDER ANY LEGAL THEORY AND/OR UNDER ANY CIRCUMSTANCE WHATSOEVER. IN ANY EVENT, ANY DAMAGES IN ANY SITUATION SHALL BE LIQUIDATED DAMAGES AND MAY NOT EXCEED THE RETAIL PRICE OF THE PRODUCT. RSE SHALL NOT BE LIABLE FOR ANY LOSS, DAMAGE OR INJURY DIRECTLY OR INDIRECTLY ARISING FROM THE USE OF OR INABILITY TO DETERMINE THE USE OF THE PRODUCT. THE ORIGINAL PURCHASER IS RESPONSIBLE TO DETERMINE THE SUITABILITY OF THE PRODUCT FOR ITS INTENDED USE, PRIOR TO USING THE PRODUCT, AND THE ORIGINAL PURCHASER ASSUMES ALL RESPONSIBILITY AND RISK IN CONNECTION THEREWITH.

For questions or concerns: please contact our office at 435-752-4580 and ask for the warranty department or email us at warranty@rockslideengineering.com.



MADE IN THE USA

GENERAL MAINTENANCE MANUAL

To ensure your Step Sliders function properly, some maintenance is required!
Properly clean and lubricate your Step Sliders after any off-road adventure and frequently during winter months.

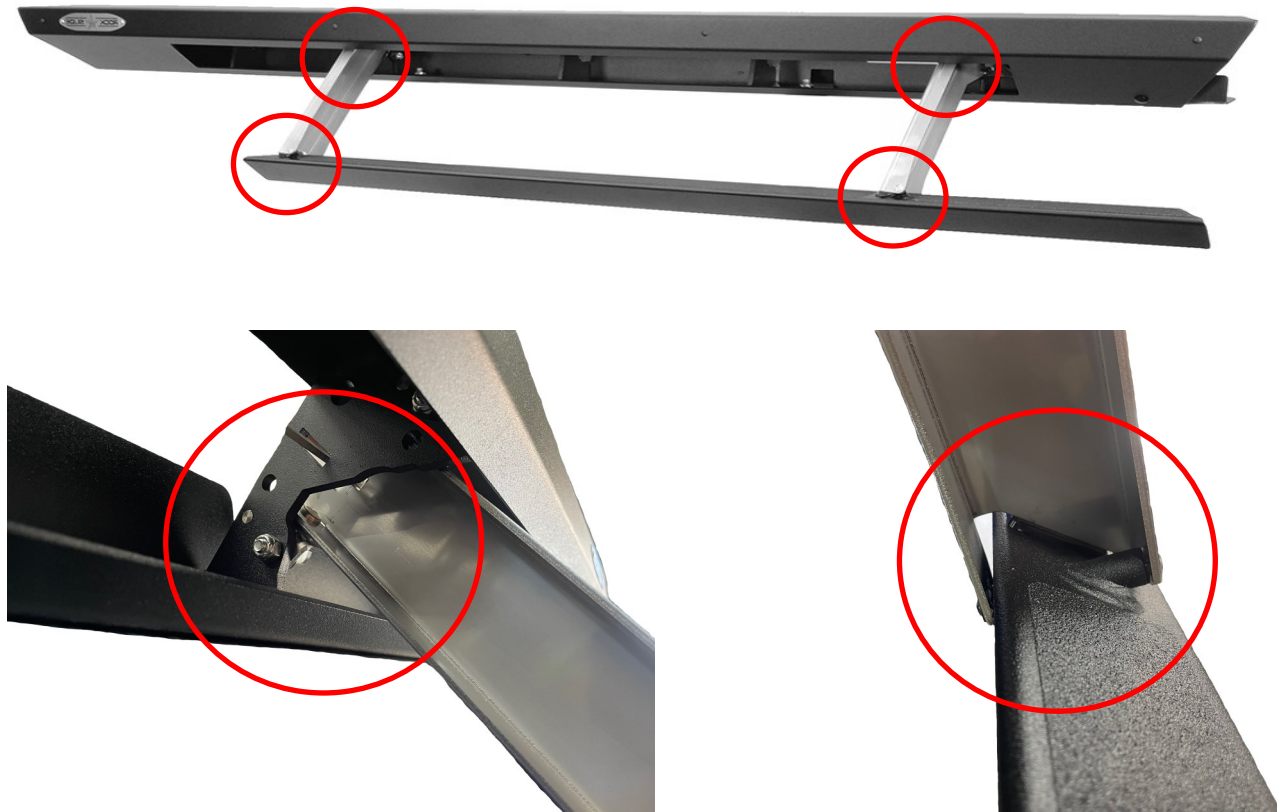

Deploy the steps to pressure wash the body of the Step Slider and the internals.
Apply a multipurpose lubricant in each of the pivot joints, and a dry Teflon lubricant spray on the spring when clean.



Here are some lubrication options you can find in your local stores!