



# INSTALLATION INSTRUCTIONS

Product: Quicker Disconnects™  
Part Number: JKS2032 - JKS2033

Applications: Jeep Wrangler JL, 2018; JT Gladiator, 2020

517-278-1226 • jks@ridefox.com • www.jksmfg.com  
491 W. Garfield Avenue, Coldwater, MI 49036

## Welcome

CONGRATULATIONS on purchasing a set of new Quicker Disconnects™ from JKS Manufacturing. We are committed to providing you with the best products available and your satisfaction is our first priority.

PLEASE READ these Installation Instructions carefully, and save them for future reference, as they contain important installation and maintenance information.

## Tools Required

- Metric/Standard Socket Wrench Set
- Torque Wrench
- #1 Philips Screwdriver or Small Punch
- 15/16" Open-End Wrench
- 18mm & 19mm Open-End Wrenches
- Grease Gun with Zerk Fitting Coupler
- Wheel Bearing Grease
- Cutoff tool

## Parts

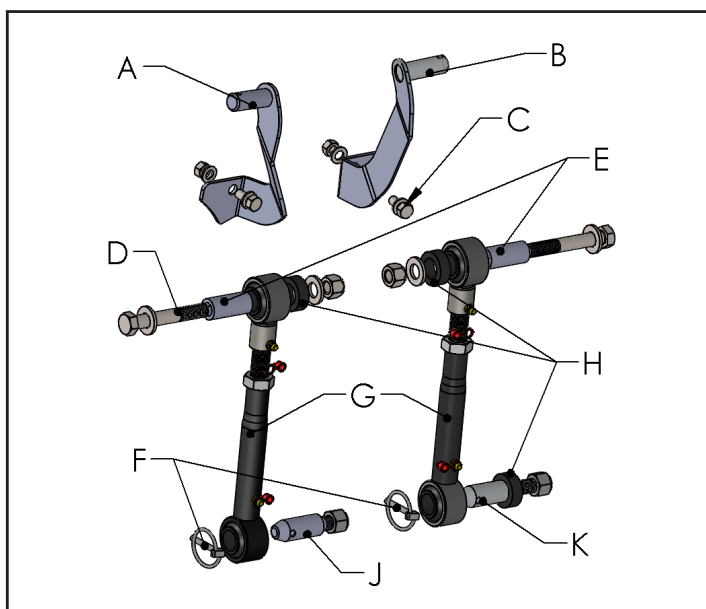

<b>A</b>	Passenger Side Retention Bracket
<b>B</b>	Driver Side Retention Bracket
<b>C</b>	5/16" Hardware (J127)
<b>D</b>	M12 x 75mm Hardware (J127)
<b>E</b>	3/4" x 1-5/8" Sleeve
<b>F</b>	Click Pin
<b>G</b>	Quicker Disconnect Assembly
<b>H</b>	Polyurethane Spacer
<b>I</b>	Lower Female Threaded End Assembly
<b>J</b>	Short Disconnect Post
<b>K</b>	Long Disconnect Post

## Important Product Safety Information

For your safety and the safety of others, please read all instructions and warnings in this pamphlet and your Jeep® owner's manual and off road driving supplement before attempting installation. Within these instructions the following signal words refer to important product safety information:

### **WARNING**

Indicates hazards or unsafe situations which could result in **severe personal injury or death**.

### **CAUTION**

Indicates hazards or unsafe situations which could result in property damage or minor to moderate personal injury.

### **NOTICE**

Careful attention is required to this operation that generally does not relate to personal injury, although damage to your JKS product or other property may result if you fail to follow instructions.

### **WARNING**

#### **Higher Rollover Risk**

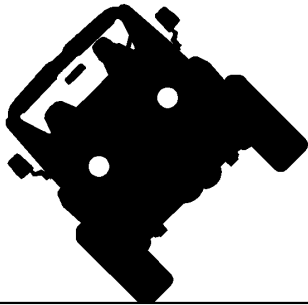

Modifying your Jeep® to improve off-road performance may result in vehicle handling different than as factory equipped, including increased ride-height and/or chassis articulation; reduced lateral stability and higher risk of roll-over or other accident. Also, owner's choice of larger tire and wheel combinations may require additional braking force or increased stopping distances.

#### **To reduce risk of serious injury and accident:**

- Choose modifications that balance your actual highway & off-road use.
- Avoid sharp turns, abrupt maneuvers or steep side-cambers.
- Avoid other maneuvering conditions which may cause the vehicle to trip, roll, lose traction or compromise your ability to safely brake in an emergency.
- Routinely inspect your vehicle components for unusual wear or off-road damage. Repair or replace any unserviceable components before use.
- Acquaint any other drivers with your vehicle modifications and handling.
- Always wear seat belts and/or appropriate off-road restraints, reduce your speed, Tread Lightly®.

### **Important**

**NOT COMPATIBLE WITH** aftermarket swaybars. Install product with Original Equipment swaybar only.

**NEVER DISCONNECT** swaybar when operating vehicle on public roads.

**WHEN DISCONNECTED**, the sway bar must be secured to the chassis in a relatively horizontal position by the retention brackets provided, lanyards, or other means. Failure to do so could cause interference with the tires or other components.

### **WARNING**

#### **Stay Connected On-Road**

On-highway safety is enhanced by controlling body roll. Never disconnect swaybar when operating on public roads.

### **WARNING**

To assure intended performance JKS® Quicker Disconnects™ are **NOT COMPATIBLE** with aftermarket Swaybars. Install **ONLY** with Jeep® factory sway bar.

On-highway safety is enhanced by controlling body roll. Never disconnect swaybar when operating on public roads.

## Installation

### ❑ 1. REMOVE ORIGINAL EQUIPMENT (OE) SWAYBAR LINKS

- Remove front swaybar links and save lower mounting hardware (18mm).

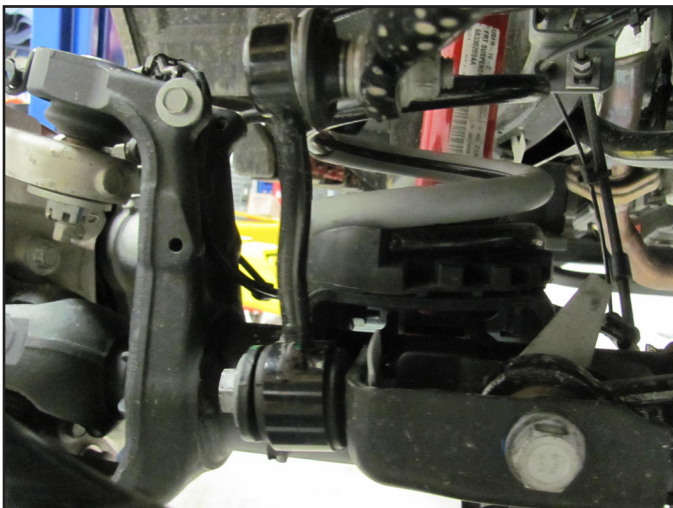
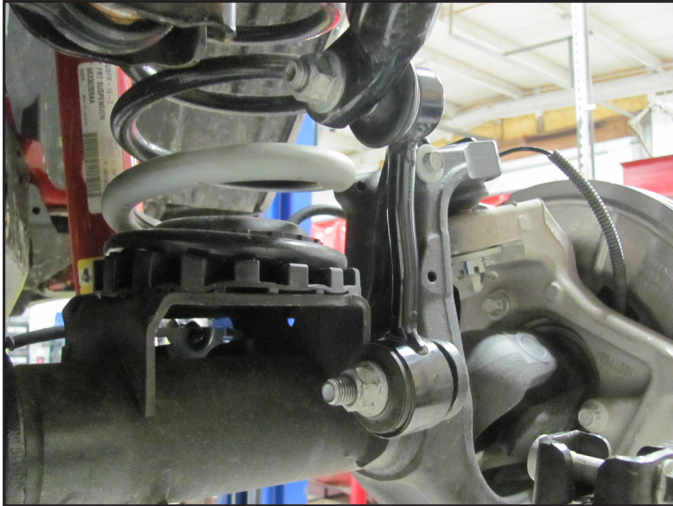

### ❑ 2. INSTALL QUICKER DISCONNECTS TO SWAY BAR

- JKS2032, adjust both of the links to 6-1/4"
- JKS2033, adjust the links to 9" for 2.5-3.5" lifts.

*These are just starting measurement and will be adjusted later in the installation.*

- Insert the longer sleeves into the upper bushing (male end) and slide the polyurethane spacer onto the upper sleeve so it will mount towards the swaybar. The links will be installed with the grease fittings forward.
- Using the provided 12mm x 75mm bolts, loosely fasten the sway bar links to the sway bar with the bolts installed from the outside towards the frame.

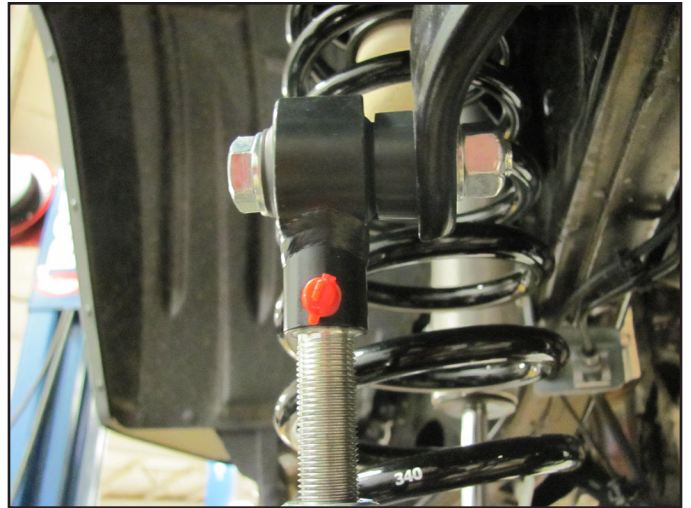

- Measure back 1-1/4" from the center of the sway bar link hole or just past the weld at the axle and make a vertical cut line. Cut off the tab at the mark and paint exposed metal.

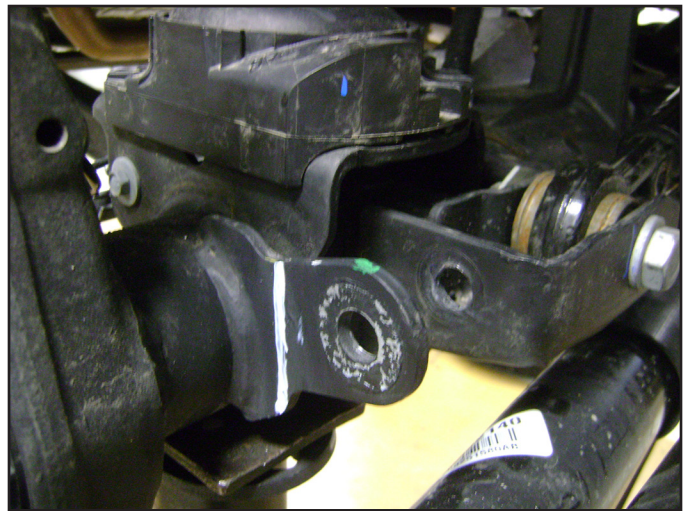

- Attach the short mounting post into the original sway bar link mount hole on the track bar bracket. Tighten the post ensuring the click pin hole is horizontal or parallel with the ground. Tighten to 65 ft-lbs.

*Note: A small screwdriver or punch inserted into the pin hole will keep the post from turning as you tighten it.*

*Note: Stud Provided in Kit JKS2032 will appear different than the one in the following photo.*



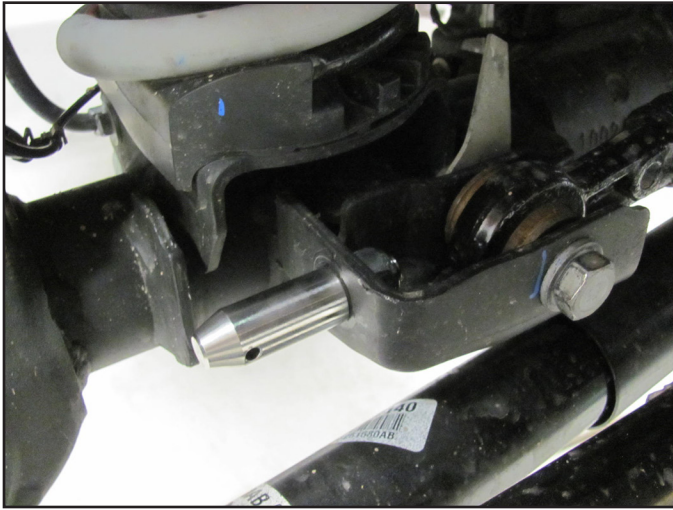

- Attach the long mounting post with polyurethane spacer into the factory sway bar link mount. The stud should point towards the center of the vehicle. Tighten the post ensuring the click pin hole is horizontal or parallel with the ground. Tighten to 65 ft-lbs.

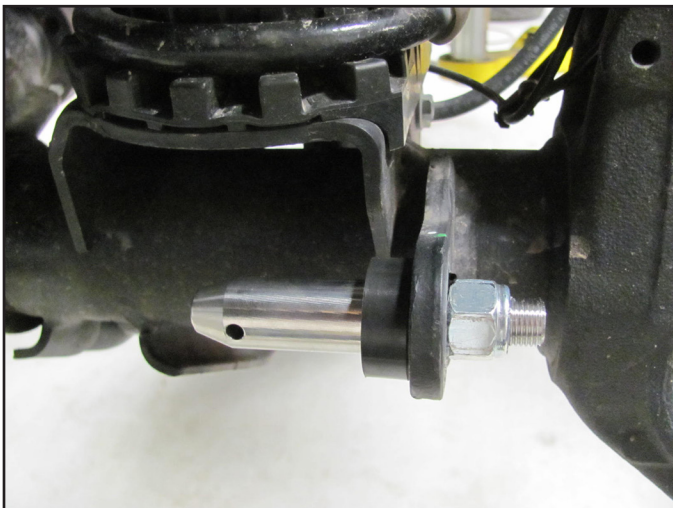

**□ 3. ADJUST QUICKER DISCONNECT LENGTH**

- At ride height the sway bar should be at approximately a 5 degree upward angle. Adjust the length of the quicker disconnects to achieve this.
- Cycle the suspension to full droop to ensure link length is adequate to prevent binding. If necessary adjust the link longer. Do not exceed the maximum lengths measured on bushings center to center:

**JKS2032 - 7-1/8" max. length**

**JKS2033 - 11-5/8" max. length**

**! CAUTION**

Max. length is based on required thread engagement. Measure & DO NOT extend Quicker Disconnects™ beyond maximum length of your part number.

- Once adjusted, tighten jam nuts firmly against the lower ends .

**IMPORTANT: Bushing cradles at both ends of quicker disconnect must remain parallel with each other when Jam Nut is tightened.**

**□ 4. INSTALL QUICKER DISCONNECTS**

- Torque the quicker disconnect to sway bar mounting bolts to 65 ft-lbs.
- Insert click pins as illustrated to secure.

**CORRECT**

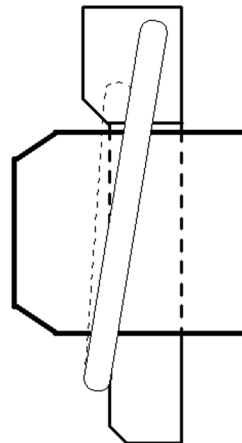

**WRONG**

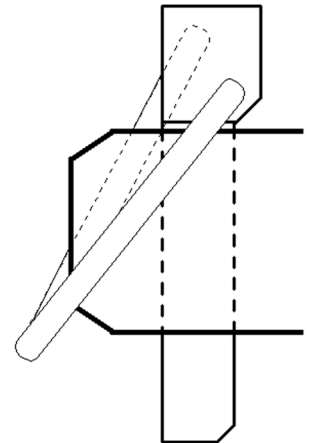

*When properly installed, the ring on the Click Pin will “snap” against the shaft of pin. When installed backwards, the ring does not fit snugly against shaft.*

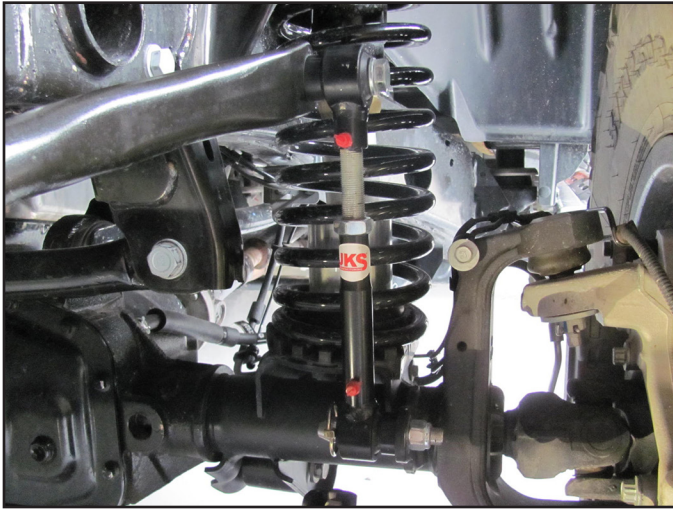

## ❑ 5. INSTALL QUICKER DISCONNECTS RETENTION BRACKETS

- Install the retention brackets using the provided 5/16" bolts into the factory hole in the front of the coil bucket as shown. These are designed to slightly form to the edge of the coil bucket to hold them in place.

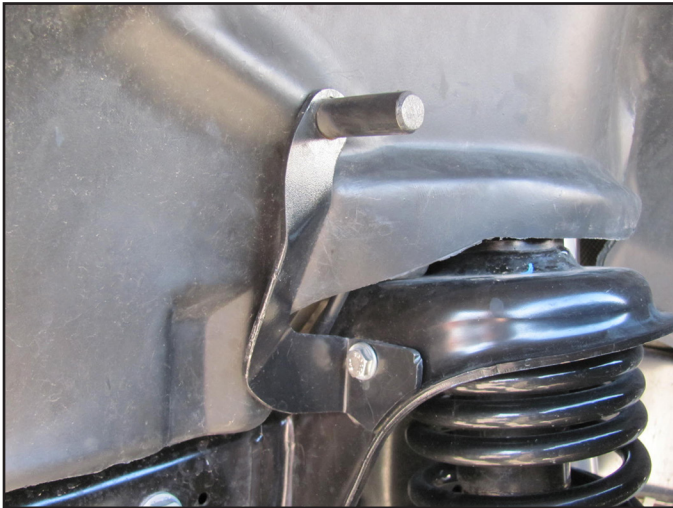

- **Mojave models only:** The reservoir hose retention bracket needs to be slightly reformed away from the frame rail. The christmas tree clip utilizing the hole in the coil bucket can be removed and will not be reused. Remove the bracket from the frame rail, then remove the hose and reinstall. form the bracket where shown below so that it is ~90 degrees to the frame. A crescent wrench works well for this task. Remove the bracket from the frame again and reinstall the hose in the same position. The bracket can now be reinstalled on to the frame rail.

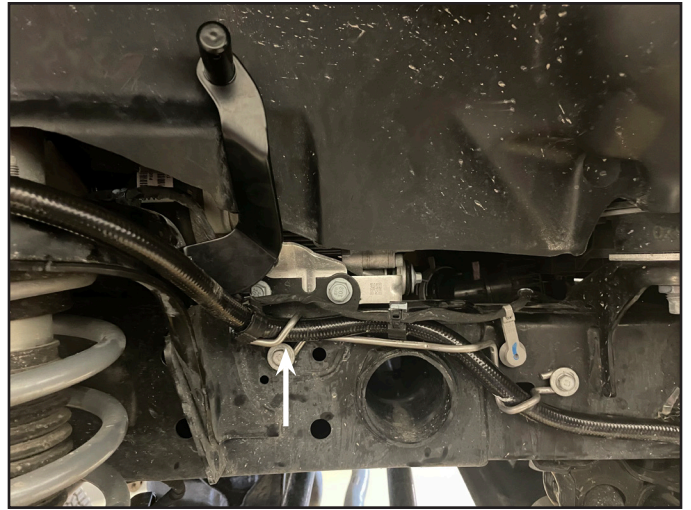

- With the vehicle at ride height, slide the ends of the disconnects on to the axle posts. Insert click pins to secure.
- Torque the quicker disconnect to sway bar mounting bolts to 65 ft-lbs.

## ⚠ CAUTION

*When disconnected with the retention brackets, adequate bump stop must be in place to prevent sway bar to steering interference under extreme conditions. In most cases the lift system should have adequate bump to ensure clearance. If adequate bump stop is not present, a lanyard kit may be required instead of the retention brackets.*

## ❑ 6. LUBRICATE QUICKER DISCONNECTS

- Lubricate all grease zerk fittings on the Quicker Disconnects immediately after installation using common wheel bearing grease or equivalent.

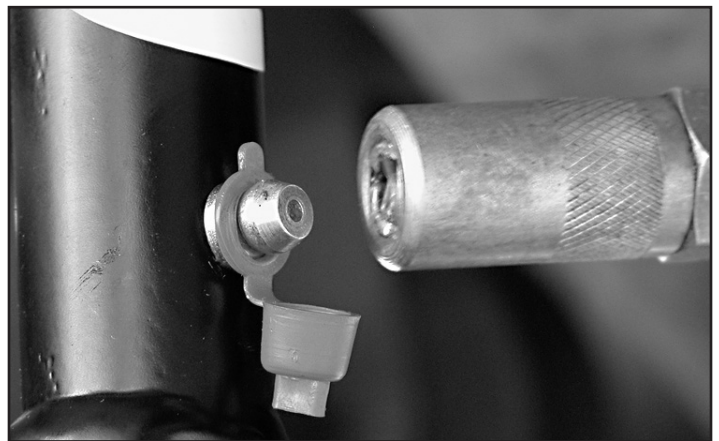

## □ 7. **CORRECT OPERATION OF QUICKER DISCONNECTS**

- Remove the click pins from the axle and slide the disconnects off of the axle posts.
- Rotate the quicker disconnect up until they fit onto the retention bracket. The sway bar may need to be rotated to get them in place.
- Reattached the click pins to the retention brackets to hold them in place.
- To reconnect, remove click pins from retention brackets and slide the links down to the axle.
- Slide quicker disconnects back onto the mounting posts and re-install click pins.

If you encounter any problems with your installation and setup, please contact JKS Manufacturing for technical assistance.

### **JKS Technical Support**

<b>Phone</b>	517-278-1226
<b>E-Mail</b>	jks@ridefox.com

## **Troubleshooting**

If swaybar does not rotate freely enough, remove from vehicle, clean and apply rubber lubricant to chassis-mounted bushings, and reinstall.

## **Maintenance**

It is important to lubricate Quicker Disconnects frequently for the first three (3) months after installation to evacuate contaminants that may build up during break-in period.

After break-in period, Quicker Disconnects should be lubricated regularly as part of vehicle maintenance schedule.

Regular cleaning with pressurized water is recommended to maximize ease of operation and reliability. Always lubricate afterwards to evacuate any moisture.

---

©2019 JKS Manufacturing  
Revision Date 9/8/21