

# Installation Guide

MRCHDDVRJW



## FULL SCREEN REAR-VIEW MIRROR MONITOR WITH DVR & SPARE TIRE MOUNTED CAMERA KIT



2007-2018 Wrangler JK/JKU  
2018 and Up Wrangler JL/JLU



## Important

Please read and follow the instructions carefully. To emphasize special information, the symbol  and the words Warning, Caution and Note have special meanings. Pay special attention to messages highlighted by these signal words.

These instructions are designed as a guide to help make the installation of this product successful. Always use caution and ask for assistance if you are not sure how to proceed.

AAMP Global & EchoMaster are not responsible for any damage that may occur during installation or any changes to the vehicle interior.

 **WARNING**

Indicates a potential hazard that could result in a death or serious injury

 **CAUTION**

Indicates a potential hazard that could result in vehicle damage

**NOTE**

Indicates special information to make installation easier or instructions clearer.

## Vehicle Preparation & Protection

 **CAUTION**

Consult your vehicle owner's manual to disconnect the battery. Do not disconnect ANY airbag connectors or indicators. Doing so may result in activating a diagnostic code. These codes will require the dealer to perform the reset procedure which may incur a reset fee. If you are unsure of any vehicle trim removal process consult the OEM service manual.

Removing vehicle trim panels in extreme hot and/or cold climate could result in damage. Use care when removing all vehicle trims. Using painter's blue tape on the vehicle trim panels can help limit any scratches and/or marring. Use a nylon trim panel removal tool whenever possible.

**NOTE**

Consult Vehicle owners guide before disconnecting negative battery cable

 **WARNING**

DO NOT TOUCH the positive terminal with any tool when removing the negative battery cable

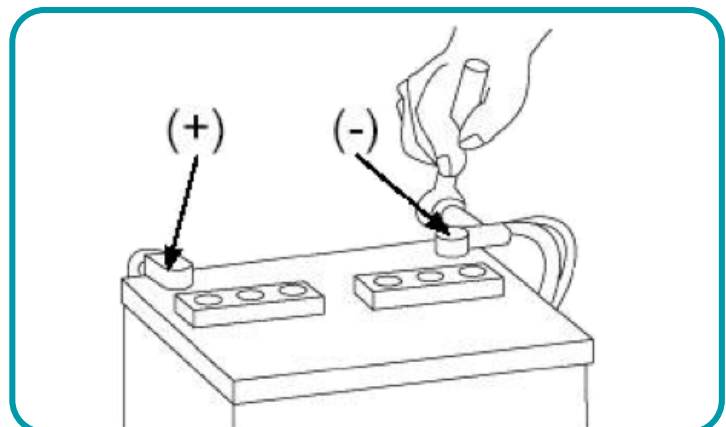

## What's in the box



Image	Description	Qty
1	Mirror Monitor / Dash Camera	1
2	Monitor Power / Video Cable	1
3	Camera Extension Cable	1
4	Spare Tire Mounting Bracket	1
5	GPS Antenna	1
6	Rear Camera	1
7	JW Camera Bracket (PMRC-BRKT)	1
8	Riser Plate	1
9	Push Nuts	3
10	JL Mirror Mounting Bracket (MRC-JLBRKT)	1

NOTE: The kit consists of three boxes (MRC-HDDVR / JP3-MOUNT / MRC-JLBRKT). There are additional parts included that will not be used.



## Recommended Tools

*Lug Wrench*

*Plastic Trim Tool*

*7mm Socket*

*8mm Socket*

*10mm Socket*

*Ratchet*

*Socket Extension*

*#1 Phillips Screwdriver*

*#2 Phillips Screwdriver*

*Diagonal Cutters*

*Wire Crimpers*

*Electrical Tape*

*Wire Feeder*

*Allen Wrench Set*

*Hammer*

*11/16" (17mm) Deep Socket*

*Small Pick Tool*

*Zip Ties*

*Utility Knife*

*Torx T-20, 25, 30, 40*

## Installation Notes

Read this installation guide thoroughly before disassembling vehicle or making wire connections. Installation of this product requires technical skill, experience, and specialized tools. If unsure, it is recommended to have it professionally installed by an authorized EchoMaster Dealer.

This guide covers both Wrangler JK and JL installations.

A video installation guide is available at:  
<https://stingerelectronics.com/installvideos>



### Questions?

Reach out to our Technical Support Team:

Phone: 727-592-5991

Email: [support@aampglobal.com](mailto:support@aampglobal.com)

Chat: [EchoMaster.com](https://www.echo-master.com)

Illustrations are typical and may not match exact vehicle detail

## Rear Camera Bracket (JK & JL)

The MRC-HDDVR Rear Camera comes with a “universal” bracket attached. For all Wrangler installations, the universal bracket will need to be removed and the JW Camera Bracket from the JP3-MOUNT will need to be installed by following the steps below.

### Step 1

Using a #1 Phillips screw driver, remove the two screws securing the universal bracket from the back of the camera and remove.

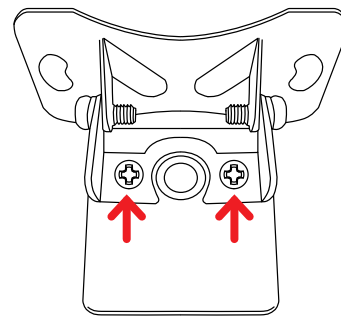

### Step 2

Attach the JW Camera Bracket using the same screws removed in Step 1.

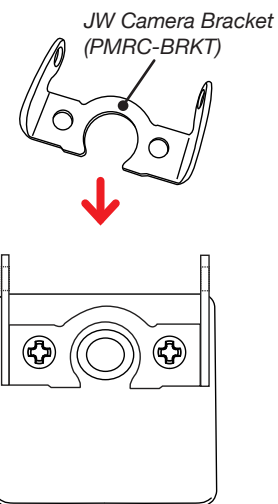

Illustrations are typical and may not match exact vehicle detail



## Spare Tire Camera Mount (JK & JL)

Using the JP3-MOUNT kit, attach the camera and assemble the mounting bracket as shown.

### Step 1

Using two M3 x .50 screws and lock washers, attach the camera to the Camera Mounting Plate.

### Step 2

Using a M6 x 1 screw and lock washer, attach the Camera Mounting Plate to the Right Angle Bracket as shown.

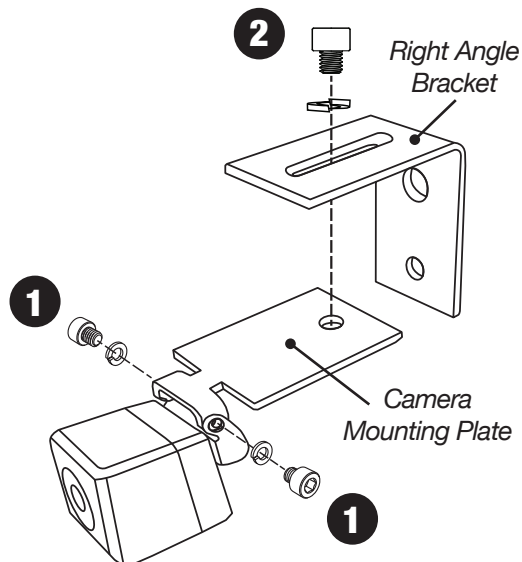

### Step 3A

For most applications with stock/standard wheels, attach the camera bracket assembly to the Wheel Bracket using a M6 x 1 screw and lock washer.

For applications with larger wheels and/or off-center wheel openings, see step 3B.

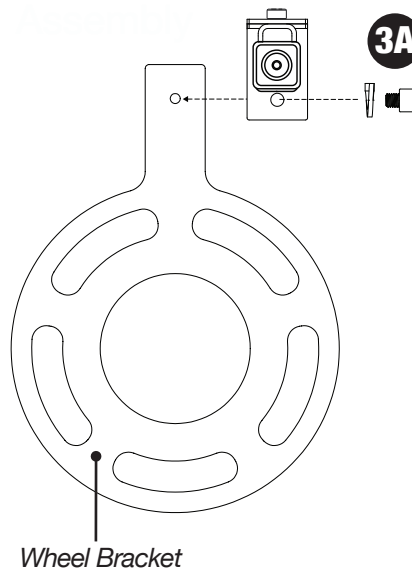

Illustrations are typical and may not match exact vehicle detail

## Spare Tire Camera Mount (cont)

### Step 3B

For larger wheels, attach the Riser Plate to the Wheel Bracket and attach the camera assembly to the Riser plate using M6 x 1 screws and lock washers.

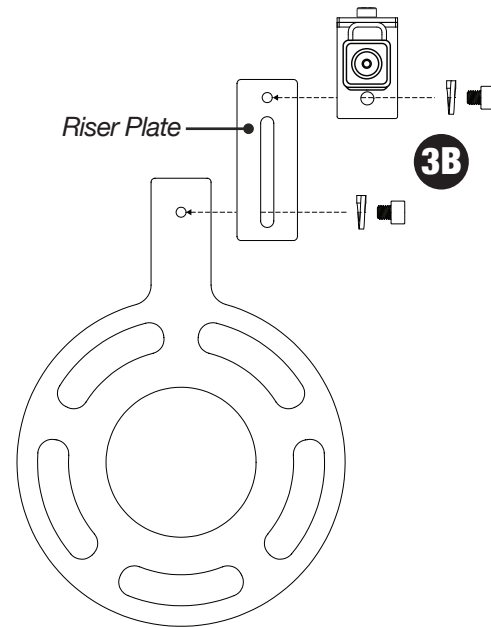

When using the riser plate, the camera height, angle and rotation can be adjusted to match the wheel.

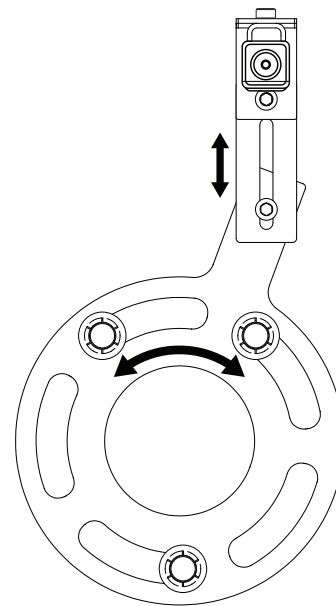

Illustrations are typical and may not match exact vehicle detail



JK Installation Instructions start here on Page 9

For JL Installation Instructions, skip ahead to Page 21

After the installation is complete, Operating Instructions start on Page 11 of the User Manual included with the MRC-HDDVR

## Mounting the Rear Camera (JK)

### Step 1

Remove the spare tire off of the tire carrier.



### Step 2

Place the Spare Tire Mounting Bracket and camera assembly on the wheel studs and secure with the three push nut retainers included in the JP3-MOUNT.

The push nut retainers are installed using a 11/16" (17mm) deep socket and a hammer.

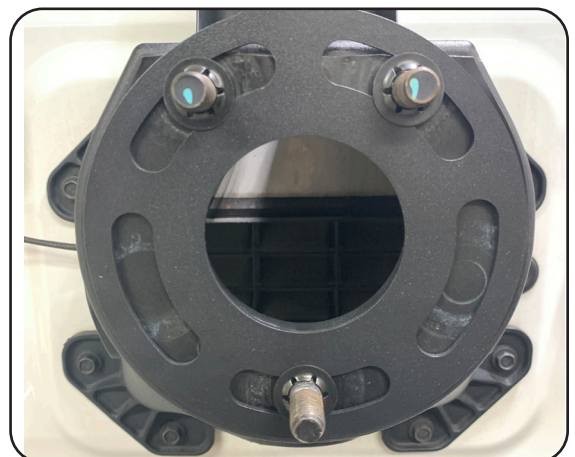

Illustrations are typical and may not match exact vehicle detail



## Mounting the Rear Camera (cont)

### Step 3

Temporarily install the spare tire. Confirm a usable opening in the wheel is located at or close to center. This may require removing and rotating the wheel until a usable opening is located. If using the Riser Plate, the camera can be adjusted up and down.

Remove the spare tire. Tighten all camera mount hardware.



## Routing the Camera Cable (JK)

### Step 1

Remove the trim panel on the inside of the tailgate by pulling it away from the tailgate along the bottom of the panel from one side to the other. Then swing the panel upward to disengage the upper tabs. A plastic trim tool may be needed for this step.



### Step 2

Remove the vent panel on the inside of the tailgate by pulling it away from the tailgate along the left side of the panel and releasing the tabs on the right side. A plastic trim tool may be needed for this step.



Illustrations are typical and may not match exact vehicle detail



## Routing the Camera Cable (cont)

### Step 3

Route the camera cable through the opening in the top of carrier and through the opening on the side.

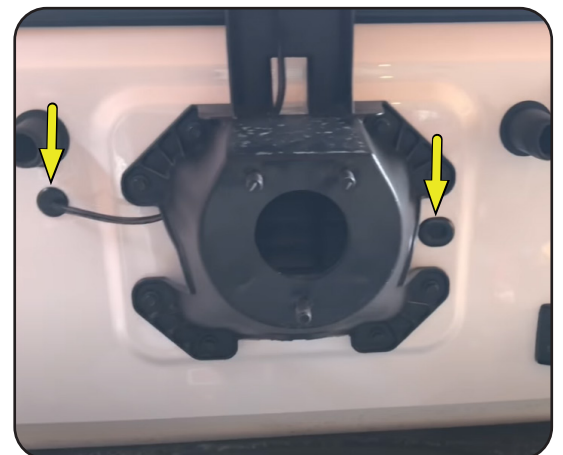

#### NOTE

There are rubber grommets on both sides of the tire carrier. Either one can be used to route the cable to the inside of the tailgate.

### Step 4

Remove one of the rubber grommets.

### Step 5A

Left Side Grommet: Rotate the grommet 180 degrees so that the side that faces down is facing up. Using a utility knife, make a cut from the outside edge to the middle paying special attention to not cut yourself or the existing wires.



Illustrations are typical and may not match exact vehicle detail

## Routing the Camera Cable (cont)

### Step 5B

Right Side Grommet: With the grommet removed, fold it in half and cut a small slit in the center using diagonal cutters or similar.



### Step 6

Feed the camera cable through the grommet and then into the inside of the tailgate.



### Step 7

Using the vent opening to access the inside of the tailgate, feed the camera cable out the access hole along with the factory wiring harness.



Illustrations are typical and may not match exact vehicle detail



## Routing the Camera Cable (cont)

### Step 8

Route and securely zip-tie the camera cable to the factory wire harness running across the tailgate.



### Step 9

Inside the cargo area, fold up the rear passenger roll bar cover and pop up the plastic seatbelt guide using a plastic trim tool. Slide it up the seat belt so that it is out of the way.



### Step 10

Using a plastic trim tool remove the back side cover from the base of the roll bar.



Illustrations are typical and may not match exact vehicle detail

## Routing the Camera Cable (cont)

### Step 11

Remove the 10mm nut that fastens the rear trim panel into place.

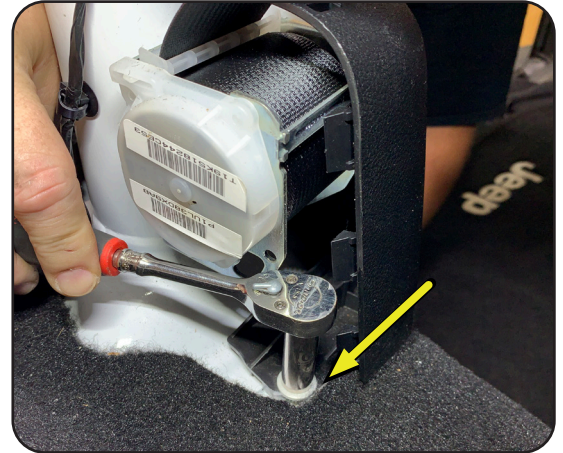

### Step 12

Remove the (2x) T30 Torx bolts that fasten the right side tie-downs and rear trim panel into place.



### Step 13

With all the nuts and bolts removed, pull the rear trim panel towards the center of the vehicle to remove it.

#### NOTE

Unplug the factory subwoofer and/or power port on the backside of the panel if equipped.



Illustrations are typical and may not match exact vehicle detail



## Routing the Camera Cable (cont)

### Step 14

Prepare the passenger side door sill for removal by removing the two plastic fasteners.

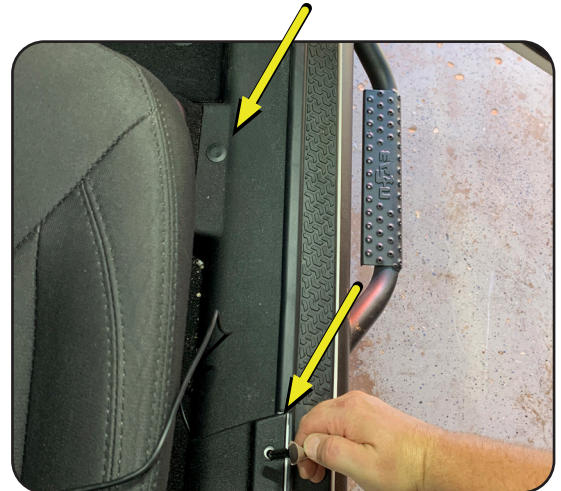

### Step 15

Grab the passenger side door sill at the front most edge and pull it towards the middle of the vehicle to release the two fasteners. Remove the sill panel and set aside.



### Step 16

Remove the glove box by squeezing the sides to release the retaining posts. Once retaining post are clear of the sub dash, tilt down and pull towards the rear of the vehicle to remove.



Illustrations are typical and may not match exact vehicle detail

## Routing the Camera Cable (cont)

### Step 17

Using a plastic trim tool remove the passenger side dash trim panel.



### Step 18

Unclip and untape the tailgate wire harness that runs into the cargo area. Using a wire feeder, route the camera cable through the fabric wire loom.

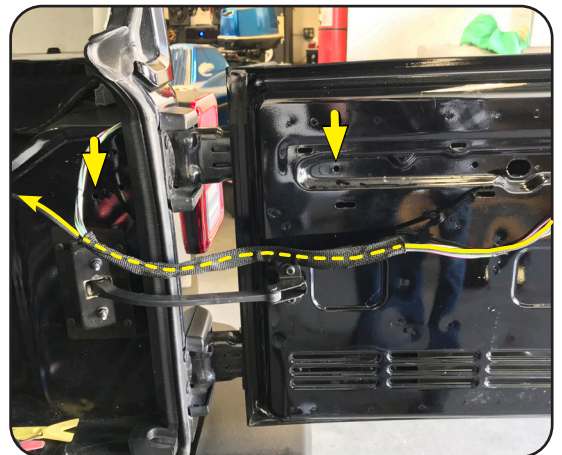

#### NOTE

The zip tie clips securing the wire harness can be removed by using a small pick tool to release the zip tie locking tab. Or the zip tie can be cut and then a new zip tie ran through the base of the clips.

### Step 19

Connect the Camera Extension Cable to the Camera Cable by lining up the arrows on the two 4-pin ends and pushing together.



Illustrations are typical and may not match exact vehicle detail



## Routing the Camera Cable (cont)

### Step 20

Locate the passenger tail light wire harness running through the rubber grommet above the tail light.



### Step 21

On most JK's, the reverse light wire color will be White with a Gray Stripe (WHT/GRY). Using a multimeter, confirm the reverse wire shows 12V when in reverse. **DO NOT START THE VEHICLE. ENGAGE THE PARKING BRAKE.** The wire can be tested with just the ignition turned on.



### Step 22

Attach the Red Reverse Trigger Wire on the cameras extension cable to the reverse wire of the vehicle.

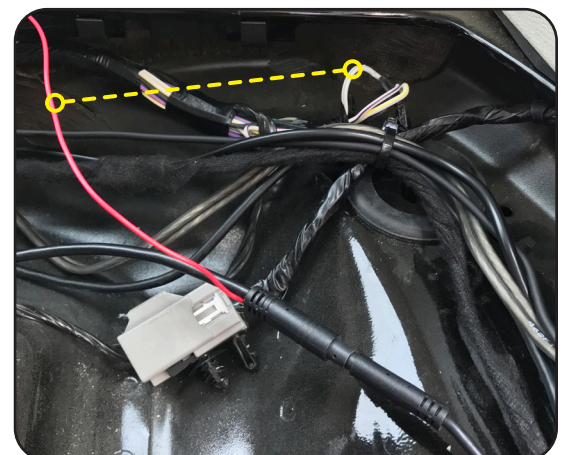

Illustrations are typical and may not match exact vehicle detail



## Routing the Camera Cable (cont)

### Step 23

Route the camera extension cable towards the front of the vehicle following the factory wire harness. Secure with zip ties.

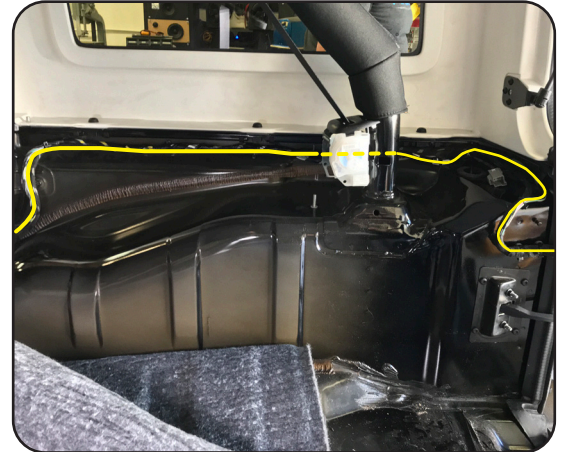

### Step 24

Continue following the factory wire harness forward, across the door sill(s), up to the glove box area. Secure with zip ties.



### Step 25

Using a wire fishing tool route the cable through the hole in the passenger side of the dash just above the speaker.

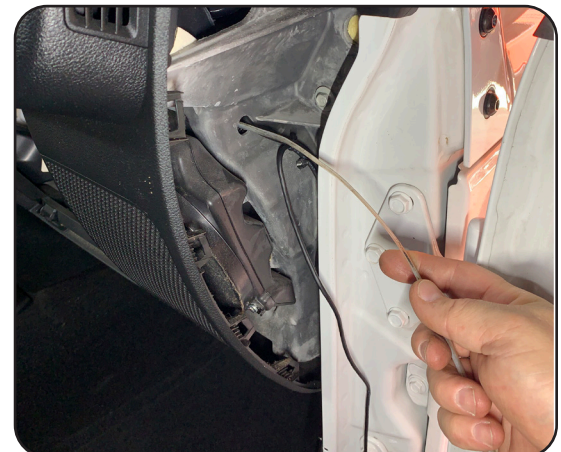

Illustrations are typical and may not match exact vehicle detail



## Routing the Camera Cable (cont)

### Step 26

Route the cable along the thick bundle of wires high in the dash and pull the remainder of the cable through the glove box opening. This will later be connected to the mirror power harness.

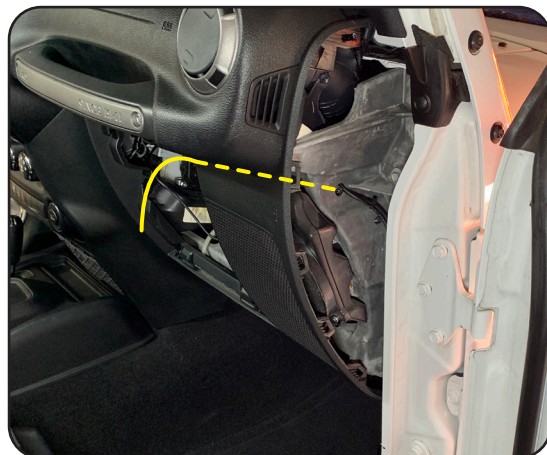

## Installing the Mirror & Harness (JK)

### Step 1

Using T20 Torx driver, loosen the set screw on the base of the factory rear view mirror. Slide the mirror upward to remove it from the windshield mounting tab.



### Step 2

If the vehicle is equipped with an auto dimming mirror, depress the clip and open the back cover. Depress the wire connector locking tab and remove the connector.



Illustrations are typical and may not match exact vehicle detail

### Step 3

Using a Phillips screwdriver, remove the push rivet from the passenger A pillar.



### Step 4

Remove the passenger sun visor by removing the two Torx T20 screws.



### Step 5

Remove the passenger A pillar trim panel by pulling to release the retaining clips.



Illustrations are typical and may not match exact vehicle detail



## Installing the Mirror & Harness (cont.)

### Step 6

Loosen the Phillips set screw on the HDDVR mounting bracket. Slide the mirror onto the windshield mounting tab. Tighten the set screw.

Attach the monitor cable to the Mirror Power/Video Harness.



### Step 7

Route the mirror cable towards the passenger A pillar, tucking the cable behind the windshield header panel.

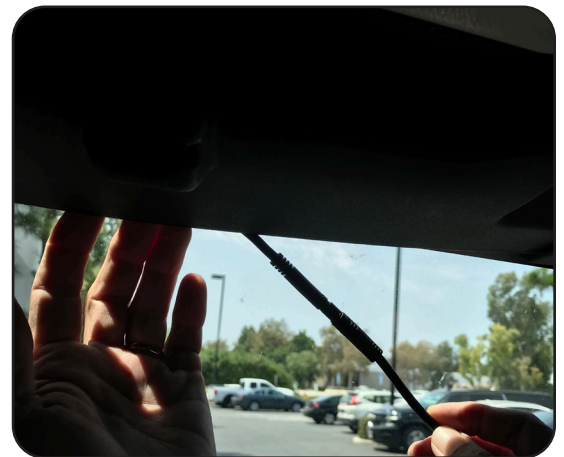

### Step 8

Route and secure the cable across the windshield frame and down the A pillar.



Illustrations are typical and may not match exact vehicle detail

## Installing the Mirror & Harness (cont.)

### Step 9

Route the harness into the dash on the passenger side and out of the glove box opening.



### Step 10

Connect the mirror monitor power and ground wires:

**BLACK** = Chassis Ground

**RED** = Switched Power

**YELLOW** = Constant Power



### Step 11

Connect the 4 pin plug on the Camera Extension harness to the matching plug on the mirror power/video harness.

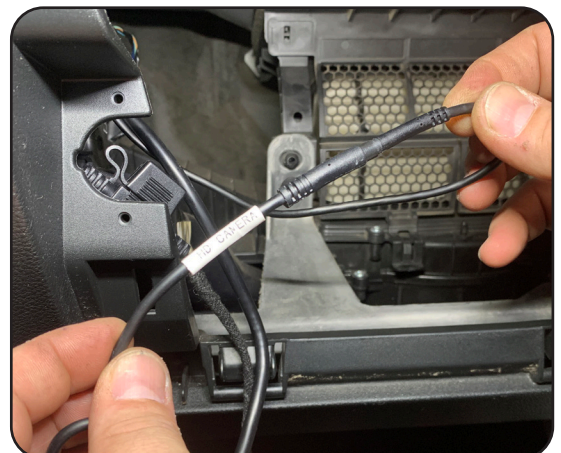

Illustrations are typical and may not match exact vehicle detail



## Test and Enjoy

After the installation is complete, Operating Instructions start on Page 11 of the User Manual included with the MRC-HDDVR

### Questions?

Reach out to our Technical Support Team:

Phone: 727-592-5991

Email: [support@aampglobal.com](mailto:support@aampglobal.com)

Chat: [EchoMaster.com](http://EchoMaster.com)

Illustrations are typical and may not match exact vehicle detail

## Mounting the Rear Camera (JL)

### Step 1

Using a T40 Torx driver, unlock the camera trim bezel and remove bezel.



### Step 2

Remove the spare tire. Place the Spare Tire Mounting Bracket and camera assembly on the wheel studs and secure with the three push nut retainers included in the JP3-MOUNT.

The push nut retainers are installed using a 11/16" (17mm) deep socket and a hammer.



### Step 3

Temporarily install the spare tire. Confirm a usable opening in the wheel is located at or close to center. This may require removing and rotating the wheel until a usable opening is located. If using the Riser Plate, the camera can be adjusted up and down.

Remove the spare tire.



Illustrations are typical and may not match exact vehicle detail



## Routing the Camera Cable (JL)

### Step 1

Route the camera cable through the factory opening in the top of carrier and through the opening towards the passenger side.



### Step 2

Remove the trim panel on the inside of the tailgate by pulling it away from the tailgate along the top of the panel and working your way from one side to the other. A plastic trim tool may be needed for this step.



### Step 3

Remove the tailgate cover on the inside of the tailgate by pulling it away from the tailgate along the top of the panel and working your way from one side to the other. A plastic trim tool may be needed for this step.



Illustrations are typical and may not match exact vehicle detail



## Routing the Camera Cable (cont)

### Step 4

Lift up the storage cover and remove the rear most trim panel that covers the jack.



### Step 5

Remove the (X3) Torx bolts securing the passenger side trim panel to the floor.



### Step 6

Using a plastic trim tool pop up the plastic seatbelt guide. Slide it up the seat belt so that it is out of the way.



Illustrations are typical and may not match exact vehicle detail



## Routing the Camera Cable (cont)

### Step 7

Remove the T20 Torx bolt that fastens the rear subwoofer trim panel into place.



### Step 8

Release the clip located by the jack compartment by pulling up on the panel.



### Step 9

Pull the whole panel assembly towards the center of the vehicle to release the clips securing it to the body of the vehicle.



Illustrations are typical and may not match exact vehicle detail

## Routing the Camera Cable (cont)

### Step 10

Pull up on the seat belt assembly trim panel and set aside.

If the vehicle is equipped with a subwoofer, disconnect the subwoofer wire harness.



### Step 11

At the front of the vehicle, release the cover panel on the passenger side kick panel. Disconnect the door check strap and the electrical connector. Remove the 10mm nut that secures the panel to the body.

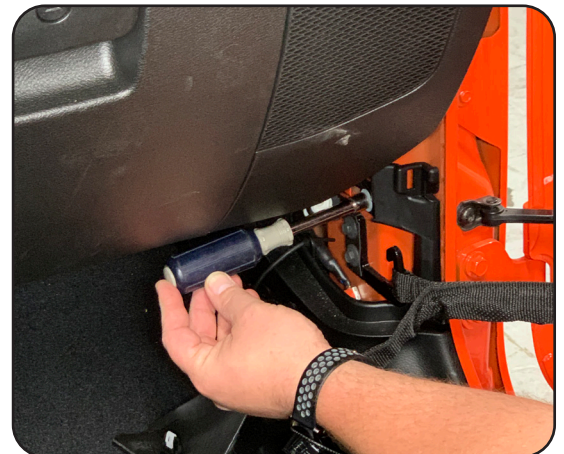

### Step 12

Lift the door sill panel at the rear, then gently pull rearward and remove.



Illustrations are typical and may not match exact vehicle detail



## Routing the Camera Cable (cont)

### Step 13

Move the front passenger seat to the full forward position. Spread the bottom of the middle B-pillar panel, then pull out to release the retaining clips and remove.



### Step 14

Using a trim stick or equivalent, release the retaining clips and loosen the lower B-pillar trim panel. Guide the seat belt through the split in the trim panel.



### Step 15

Remove the rubber grommet on the right side of the spare tire carrier.

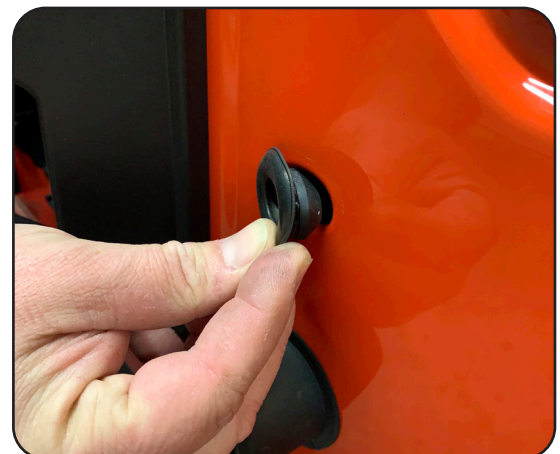

Illustrations are typical and may not match exact vehicle detail

## Routing the Camera Cable (cont)

### Step 16

Using diagonal cutters or similar, cut a slit in the grommet large enough to allow the camera cable to pass through.



### Step 17

Feed the camera cable through the rubber grommet.



### Step 18

Route a wire feeder through the grommet hole to the inside of the tailgate near the vent.



Illustrations are typical and may not match exact vehicle detail



## Routing the Camera Cable (cont)

### Step 19

Attach the end of the camera cable to the wire feeder and pull it through to the inside of the tailgate.



### Step 20

Reinsert the grommet.



### Step 18

Unclip and untape the tailgate wire harness that runs into the cargo area. Using a wire feeder, route the camera cable through the fabric wire loom.

#### NOTE

The zip tie clips securing the wire harness can be removed by using a small pick tool to release the zip tie locking tab. Or the zip tie can be cut and then a new zip tie ran through the base of the clips.

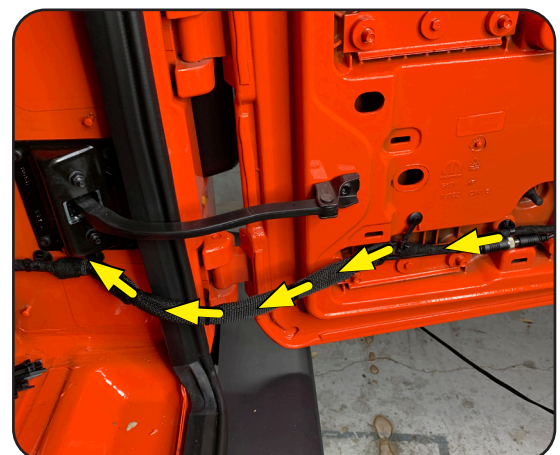

Illustrations are typical and may not match exact vehicle detail

## Routing the Camera Cable (cont)

### Step 22

Following the factory wire harness, route the camera cable up over the rear tire well. Secure with zip ties.

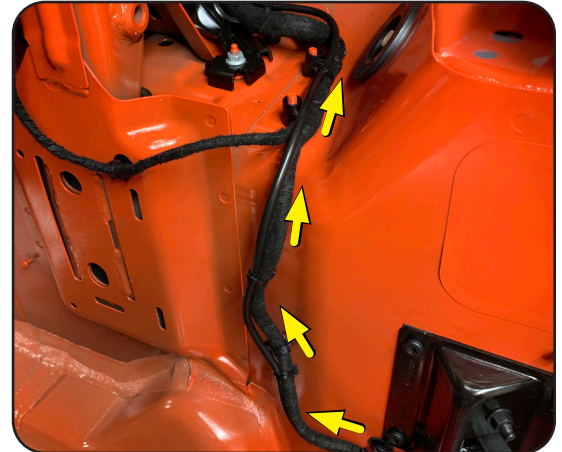

### Step 23

Connect the Camera Extension Cable to the camera cable by lining up the arrows on the two 4-pin ends and pushing together.

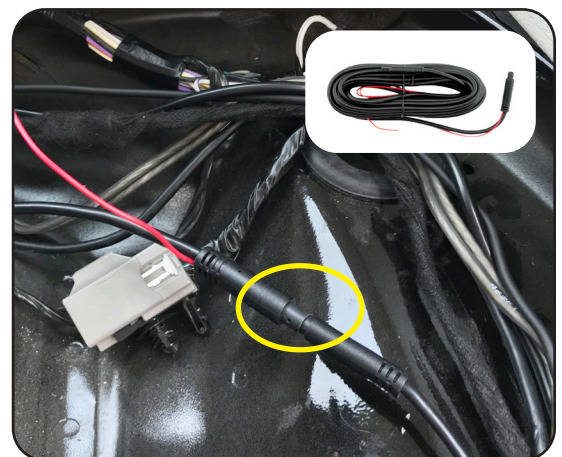

### Step 24

Locate the passenger tail light wire harness running through the rubber grommet above the passenger tail light.

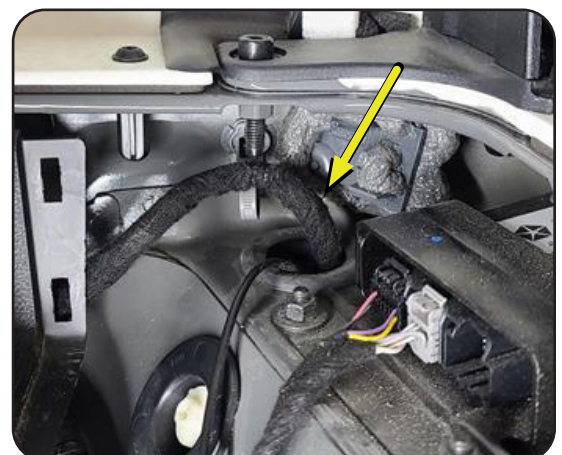

Illustrations are typical and may not match exact vehicle detail



## Routing the Camera Cable (cont)

### Step 25

Remove a portion of the wire harness cloth tape. Locate the White wire with a Purple stripe (WHT/PUR). On most JL's, this will be the reverse light wire, but it will need to be confirmed using a multimeter.



### Step 26

Using a multimeter, confirm the reverse wire shows +12V when in reverse. Testing the reverse wire will require two people. Set the parking brake before starting the vehicle and placing in reverse.



### Step 27

Attach the Red Reverse Trigger Wire on the camera's extension cable to the reverse wire of the vehicle.



Illustrations are typical and may not match exact vehicle detail



## Routing the Camera Cable (cont)

### Step 28

Continue routing the camera extension cable towards the front of the vehicle following the factory wire harness. Secure with zip ties.

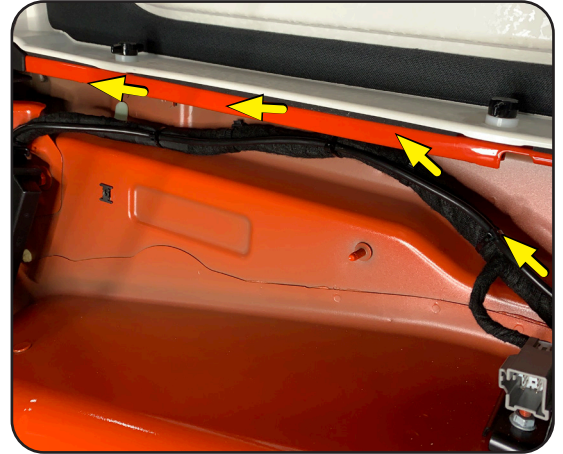

### Step 29

Route the camera extension cable through the plastic channels along the door sill(s) following the factory wire harness.

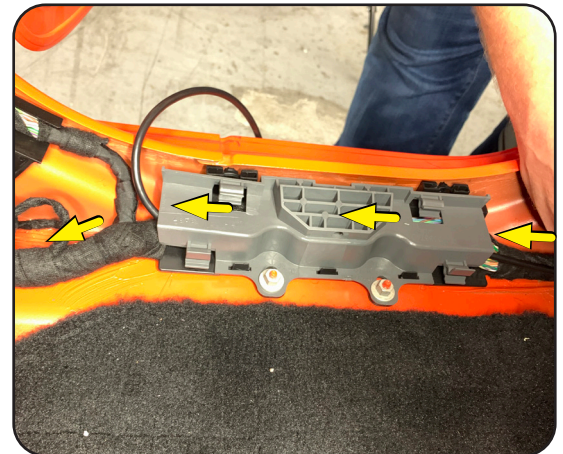

### Step 30

Finish by routing the cable up into the inner dash area behind the glove box.

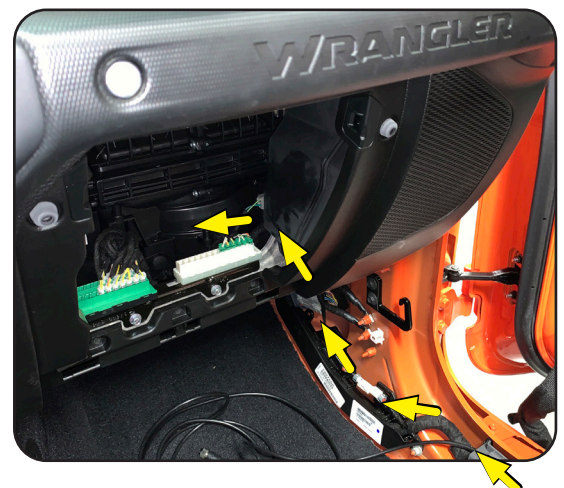

Illustrations are typical and may not match exact vehicle detail



## Installing the Mirror & Harness (JL)

### Step 1

Using a plastic trim tool remove the upper dash speaker grill.

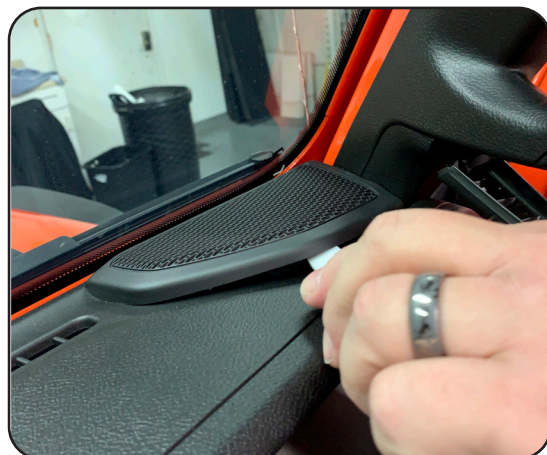

### Step 2

Using a plastic trim tool, remove the upper and lower fastener covers on the passenger A-Pillar handle.

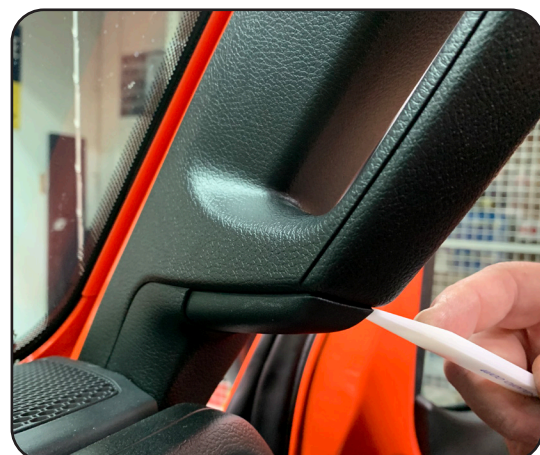
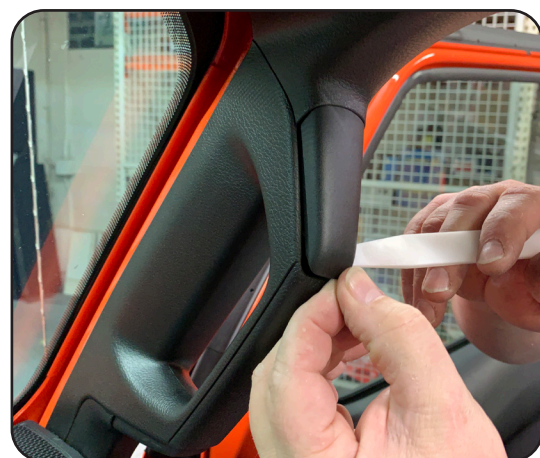

Illustrations are typical and may not match exact vehicle detail

## Installing the Mirror & Harness (cont.)

### Step 3

Remove the two 10mm bolts securing the handle.



### Step 4

Grasp the handle firmly and pull towards the center of the vehicle to release the retaining clips and remove.



### Step 5

Remove the passenger side sun visor by removing the two Torx T20 screws.



Illustrations are typical and may not match exact vehicle detail



## Installing the Mirror & Harness (cont.)

### Step 6

Remove the passenger side front roll bar trim panel by removing four Torx T20 screws and pulling the panel towards the center of the vehicle.



### Step 7

Remove the factory rear view mirror by grabbing it by the base and twisting it counter-clockwise 90 degrees.



### Step 8

If equipped with a wire harness, open the back cover plate and unplug the wire harness.



Illustrations are typical and may not match exact vehicle detail

## Installing the Mirror & Harness (cont.)

### Step 9

Pull to release the retaining clips securing the windshield header panel (1). With the header panel dropped out of the way, release the two retaining clips (2) and remove the rear view mirror base cover (3).

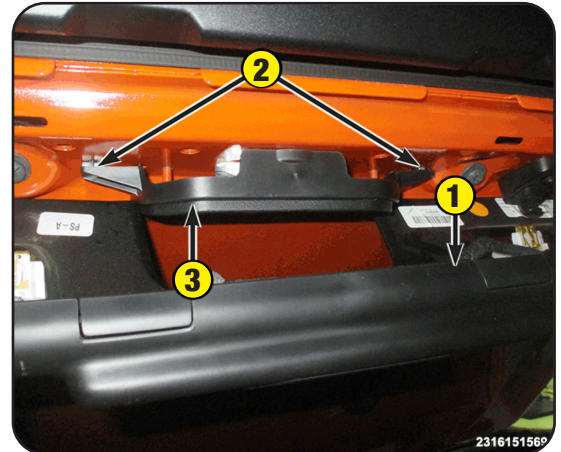

### Step 10

Remove the three Torx bolts securing the mirror mount to the windshield frame and remove the factory mirror mounting base.



The HDDVR Mirror Monitor comes with the JK mounting bracket attached. For JL installations, the JK style mount will need to be removed and the JL Mounting Bracket (PMRC-BRKT) installed by following the steps below.

### Step A

Using a Phillips screw driver, remove the screw inside the access hole on the back of the mirror bracket. Remove the JK style mount from the mirror stem.

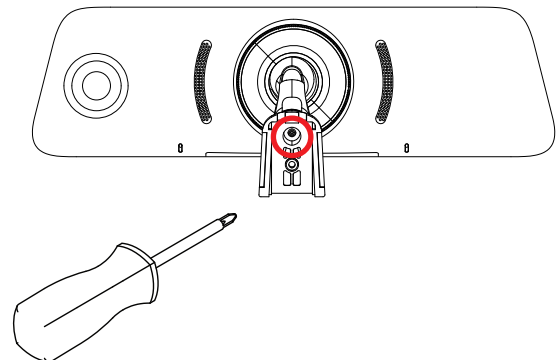



## Installing the Mirror & Harness (cont.)

### Step B

Remove the Phillips screw and washers on the JL mount and separate the two pieces.

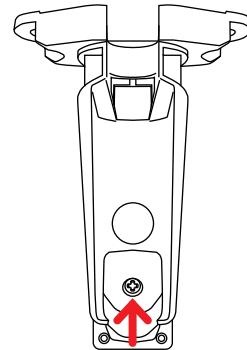

### Step C

Place the vehicles rear view mirror base cover (1) onto the mirror stem with the retaining clips facing up. Attach the JL mount to the mirror stem in the orientation shown at right. Secure with screw and washers.

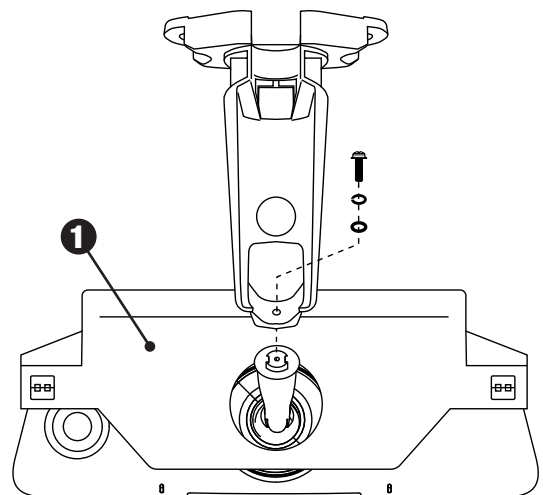

### Step 11

Secure the HDDVR mirror to the windshield frame using the three factory Torx bolts removed in Step 10. Run the mirror power harness through the hole in the middle of the mirror base trim panel and secure the trim panel back into place.



Illustrations are typical and may not match exact vehicle detail

## Installing the Mirror & Harness (cont.)

### Step 12

Align and connect the mirror wire connector to the Mirror Power/Video Cable.



### Step 13

Route the mirror cable towards the passenger side A-Pillar following the factory wiring and securing it using wire ties. Secure the windshield front upper trim panel back into place.



### Step 14

Route the mirror power harness down the passenger side A-Pillar and secure it using wire ties.



Illustrations are typical and may not match exact vehicle detail



## Installing the Mirror & Harness (cont.)

### Step 14

Route the monitor cable down into the area behind the glove box.



## Cable and Wire Connections

### Step 1

Connect the Camera Extension Cable to the mirror monitor cable.



Illustrations are typical and may not match exact vehicle detail



## Cable and Wire Connections (cont.)

### Step 2

Connect the mirror monitor power and ground wires:

**BLACK** = Chassis Ground

**RED** = Switched Power

**YELLOW** = Constant Power



## Test and Enjoy

After the installation is complete, Operating Instructions start on Page 11 of the User Manual included with the MRC-HDDVR

### Questions?

Reach out to our Technical Support Team:

Phone: 727-592-5991

Email: [support@aampglobal.com](mailto:support@aampglobal.com)

Chat: [EchoMaster.com](https://www.EchoMaster.com)

Illustrations are typical and may not match exact vehicle detail

AGREEMENT: End user agrees to use this product in compliance with the instructions and terms of use above and with all State and Federal laws. EchoMaster provides instructions and safety warnings with respect to this product and disclaims all liability for any use not in conformity with those instructions or other misuse of its product. If you do not agree, please discontinue use immediately and contact EchoMaster. This product is intended for off-road use and passenger use only.



15500 Lightwave Drive, Suite 202, Clearwater, Florida 33760

email - [support@aampglobal.com](mailto:support@aampglobal.com)  
tel - 1-800-477-2267

EchoMaster is a Power Brand of AAMP Global.  
**EchoMaster.com**

IG-MRCHDDVRJW  
REV. 082021