



# INSTALLATION MANUAL

## GEN 3 JK STEP SLIDER

2007-2018

BD-SS-300-JK4

BD-SS-300-JK2



### Newest features:

- 40% stronger with High Strength Low Alloy Steel (HSLA).
- All new Smart Motor for improved, consistent motion. Intelligent acceleration and deceleration provides quiet, smooth operation.
- Updated harness for simplified, quicker installation.
- Improved mechanical components increase reliability and reduce maintenance (warranty).

To watch a installation video on our step slider, scan the QR code with your smart phone camera!

<https://youtu.be/DSh8yatg4p8>



Description	Quantity
Electric Step Slider (Pair)	2
Bump stop plate with VHB backing	2
Wiring harness	1
Double sided adhesive strips	4
Door sensor	4
Magnets	4
Alcohol wipes	4
Rocker cutoff switch	1
1/4" push in plug	10
M10 flange bolt	1
Cable clip	1
Grommet	2
5/16" - 18 nylock nut (pinch seam)	8
5/16" grade 8 washer (pinch seam)	8
1/4" - 20 nylock nut (pinch seam)	4
1/4" - 20 grade 8 washer (pinch seam)	4
5/16" - 18 X 5/8" grade 8 hex head bolt	24
5/16" SAE yellow zinc washer	24
Front bracket (drop style)	2
Middle bracket (short style)	2
Rear brackets (long style)	2
Rocker cutoff switch bracket	1
Floor Plug Grommet	2
Zip Tie	10

Tools Required	
10 mm socket	7/16" socket
18 mm socket	1/2" socket
8 mm socket	Wrench with 3-4" extension
Breaker bar	1/2" Box end ratcheting wrench
7/16" Box end ratcheting wrench	

\*\*Optional for quicker install

Impact Gun with adapters	Heavy Duty Impact Gun with 1/2" driver
--------------------------	--

### Notes and Maintenance

Before you begin installation, read all instructions thoroughly.

Proper tools will improve the quality of installation and reduce the time required.

No maintenance required on waterproof harness or water-resistant motors.

If mud or dirt is built up on the steps, simply spray them off and let them air dry.

Mild automotive detergent may be used to clean the product. Do not use dish detergent, abrasive cleaners, abrasive pads, wire brushes or other similar products that may damage the finish.

Periodic inspection of all wires and connections should be performed to ensure there is no visible damage or loose connections.

Refer to the last page of this manual for troubleshooting, warranty and product registration information.

## Front Bracket



3 3/8 in.  
Drop Style

## Middle Bracket



4 5/8 in.  
Long Style

## Rear Bracket



5 3/8 in.  
Long Style

## Harness Diagram - 1

- A. CIRCUIT BOARD CONNECTOR
- B. MOTOR CONNECTOR
- C. LIGHT CONNECTOR
- D. REAR DOOR SENSOR CONNECTOR
- E. FRONT DOOR SENSOR CONNECTOR
- F. ROCKER SWITCH CONNECTORS
- G. ROCKER SWITCH
- H. BATTERY TERMINALS
- I. FUSE HOLDER

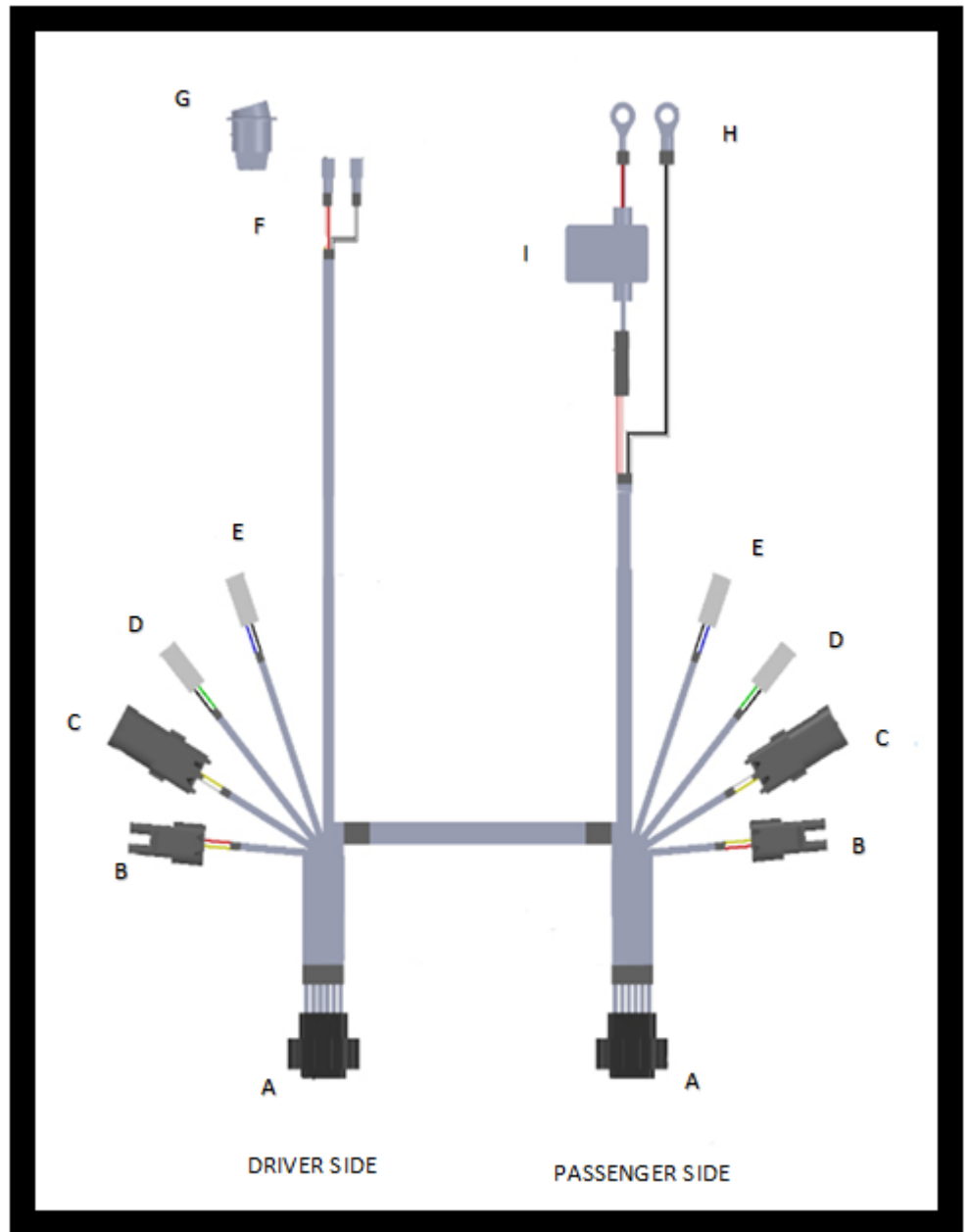
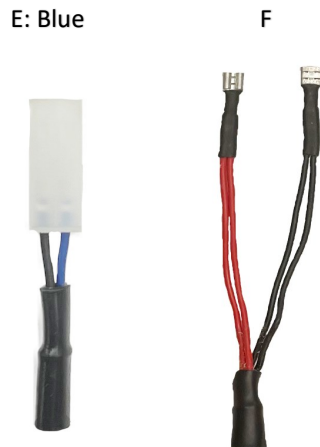
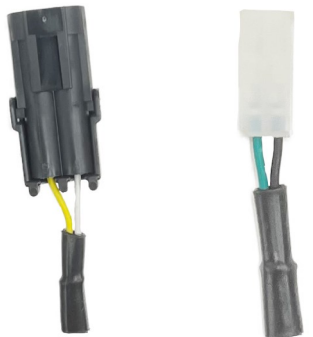

Harness Route: Passenger Side

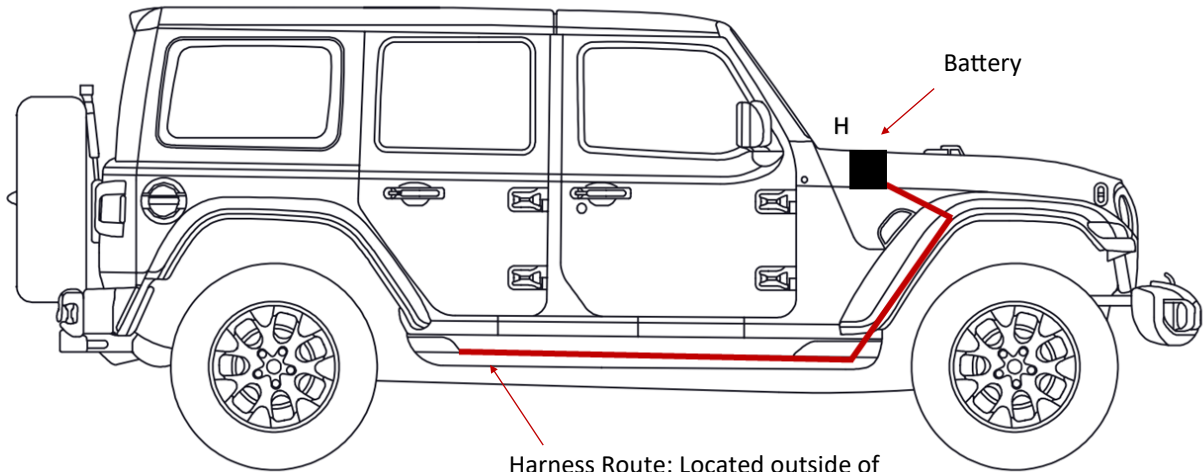

Harness Route: Located outside of the Jeep attached to the top of the frame rail.

Harness Route: Driver Side

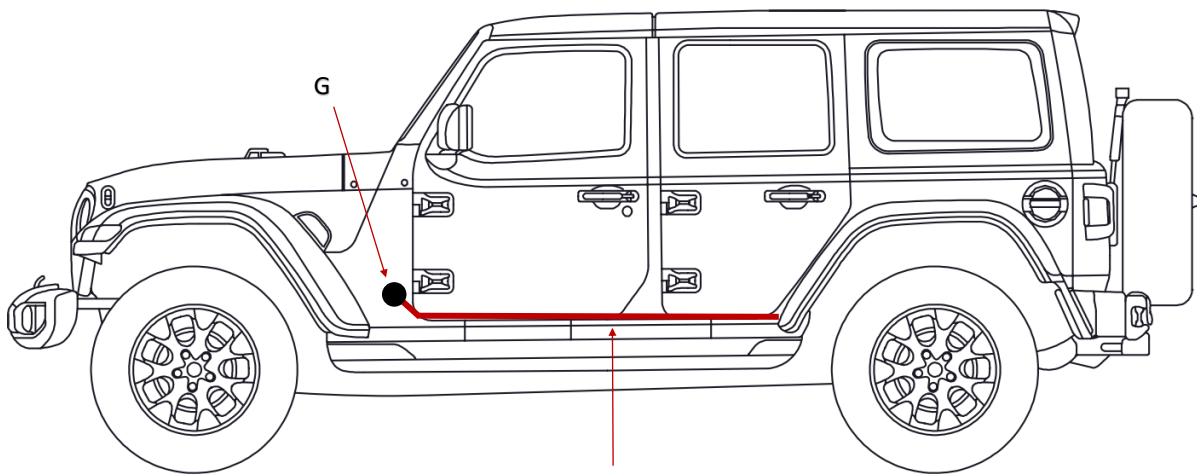

Harness Route: Located inside of the underneath the rocker panels.

Harness on 2 Door Models: You will have access harness length with a two door. Secure extra length with zip ties and follow front door sensor and magnet instructions.



**IMPORTANT**

**JK MODELS:** Option of connecting the red (+) and black wires (-) directly to the battery terminals, or connect the ground wire to an existing body bolt on the Jeep. Step 2. Pg. 7

**JL MODELS:** Must connect ground wire to an existing body bolt. If you try to attach both wires to battery terminals, you will lose 6 in. of harness length.

Harness Route: Located inside of the Jeep underneath the rocker panels.

Harness Route: Located outside of the Jeep attached to the top of the frame rail.

Harness Route: Located underneath Jeep attached to the crossmember.

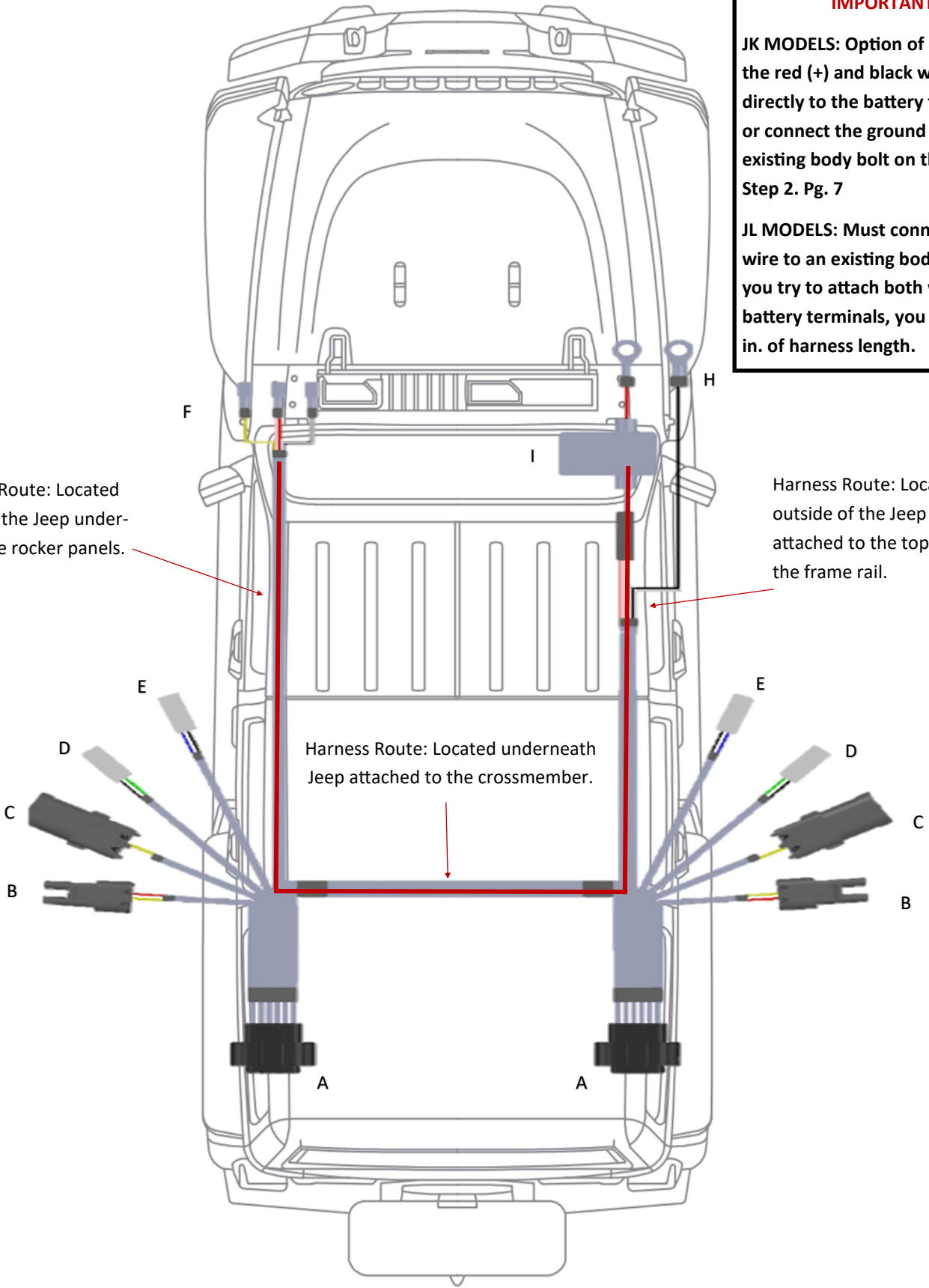

**Step 1**

**REMOVE THE FUSE FROM THE HARNESS**

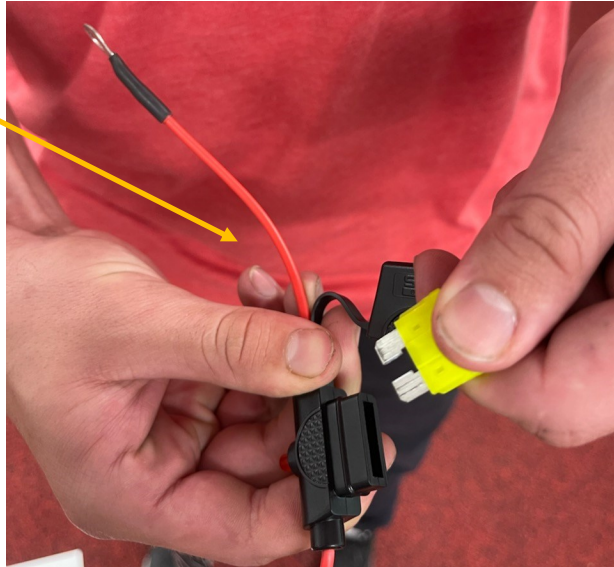
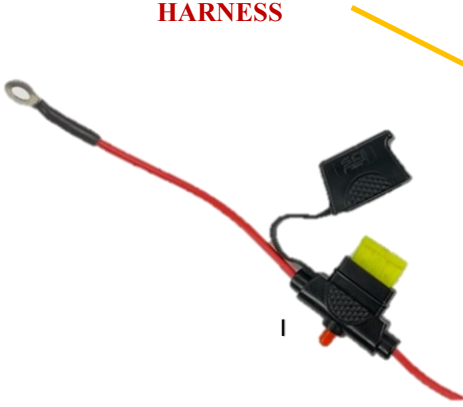

**INSTALLING THE PASSENGER SIDE OF THE HARNESS**

Once the fuse is removed: trace the passenger side of the harness with the fuse case, red wire (+) and black wire (-) from the rear passenger door along the frame rail. Fasten the first junction of wires to the existing factory harness with a zip tie behind the middle body bolt. Leaving the remainder of the harness at the passenger door free.

Passenger Side Harness Zip Tie Anchor Points

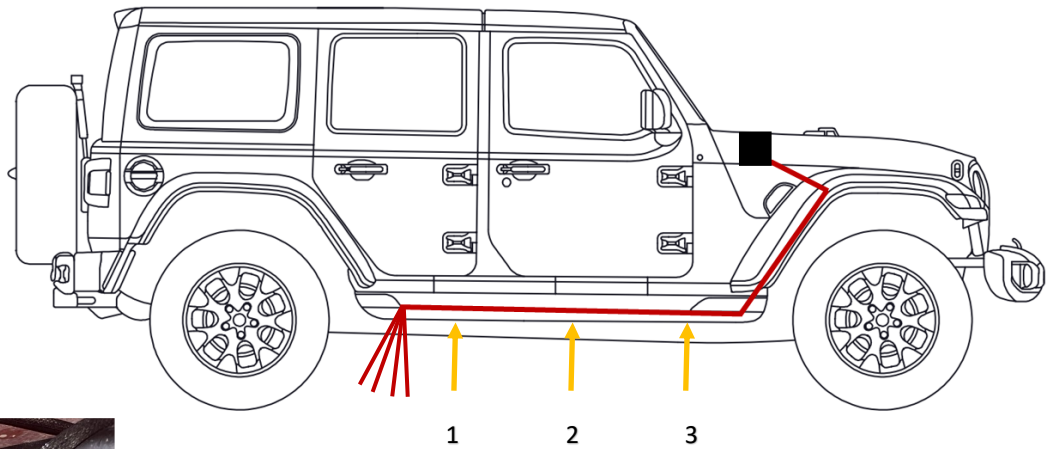

RSE Harness

Factory Harness





## Step 2

### FOR EASE OF ACCESS

It is recommended that you remove inner fenders if they are installed. This will give you easy access to the harness from the wheel well to access the lower battery area through the engine bay.

### CONNECTING TO THE BATTERY TERMINALS

#### ENSURE THE FUSE IS PULLED FROM THE WIRING HARNESS

Continue to run the red wire (+) and black wire (-) with the fuse case through the wheel well area. Use this factory access hole below the front passenger wheel well.

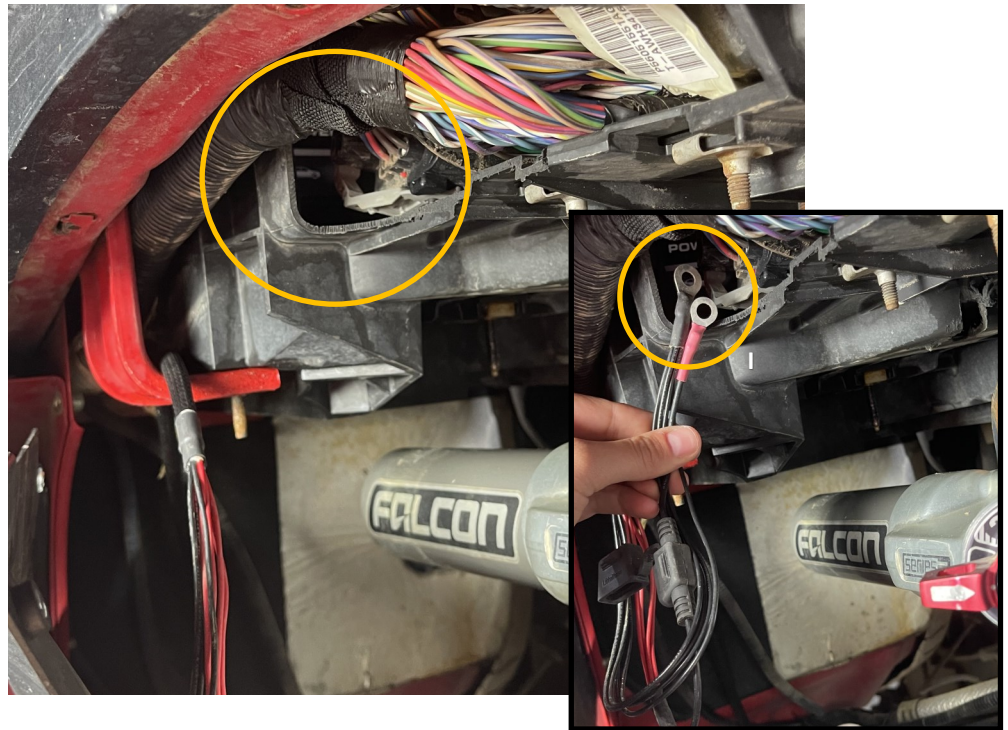

With the wires in place, attach the red wire (+) to the positive terminal and black wire (-) to the negative.

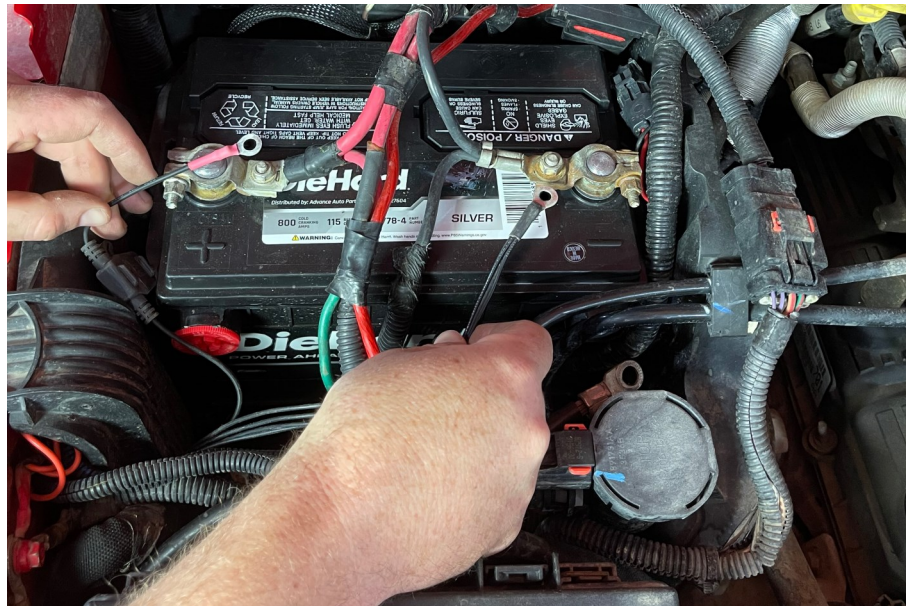

When connecting these wires, you have the option of running the black ground wire to an existing body bolt on the Jeep. Ensure it has good metal to metal contact to keep paint from interfering with the connection.

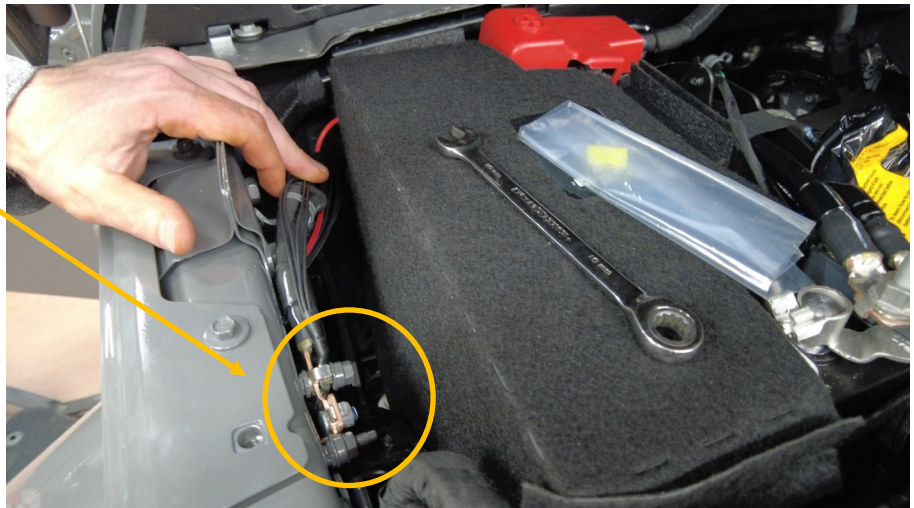



### Step 3

Pop the rocker panels on the front and rear of the passenger side to allow access to the floor plug and wiring access to the front and rear of the jeep. Place the black grommet into the floor plug . It will bend to shape.



### Step 4

Thread the green door sensor (D) and blue door sensor (E) connectors up through the floor plug on the passenger side. The circuit board (A), Motor (B) and light (C) connectors will remain visible on the passenger side.

Pull the remainder of the harness from the passenger side to the driver side over the frame rail. Run it along the cross member and secure the RSE Harness with zip ties.





## Step 5

### INSTALLING THE DRIVER SIDE OF THE HARNESS

Pop the panels on the driver side and remove the carpet to expose the floor plug. Thread the green door sensor (D), blue door sensor (E) and rocker switch (F) connectors through the floor plug and into the cab.

Leave the rear green door sensor (D) in the back. Run the front blue door sensor (E) and the Rocker Switch (F) along the existing harness towards the front of the Jeep.

The drivers side circuit board (A) and motor (B) connectors remain outside of the jeep. This should look exactly like the passenger side without a light connector (C).

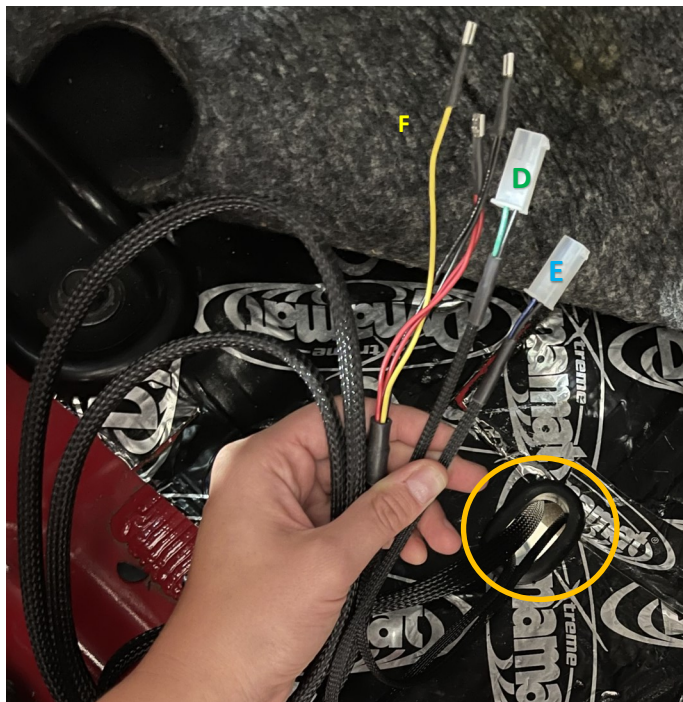

## Step 6 - Part 1

### INSTALLING REAR DOOR SENSORS

Starting on the rear doors, remove the trim panel on the B pillar. Run the rear door sensor (D) along the existing factory harness.

Using the alcohol wipes, clean this area above the rear door hinge. Making sure the surface area is clean and ready for the door sensor adhesives.

With the door sensor in hand, use the double sided adhesive and attach it to the back of the sensor. Press the sensor firmly. Expose the adhesive on the foam wire protector next to the sensor and wrap the foam around the frame metal. Connect the door sensor to the green wire (D) connector.

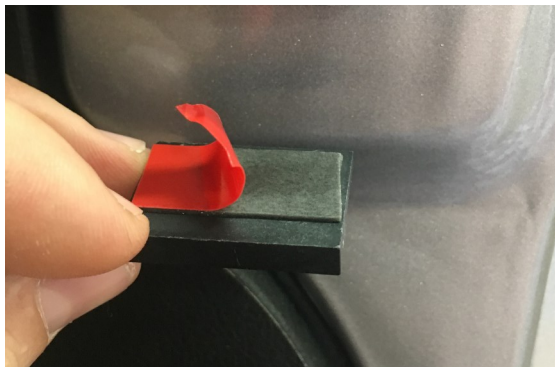

### IMPORTANT

After installing sensors and magnets, only connect one door at a time. Plug your fuse in and make sure the magnet is in the correct location. If it is, the step will deploy when you open the door and retract when you close it. Once you know the door is working, remove the fuse and move onto the next door. If the step does not deploy, you may need to adjust the location of your magnet.



### IMPORTANT

Rear door sensors are located on the INNER portion of the door on the B Pillar.

## Step 6 - Part 2

### INSTALLING FRONT DOOR SENSORS

Remove the trim panel on the front door. Run the front door sensor (E) along the existing factory harness. Use the alcohol wipes to clean directly below the door latch Striker. Making sure the surface area is clean and ready for the door sensor adhesives.

With the door sensor in hand, use the double sided adhesive and attach it to the back of the sensor. Press the sensor firmly below the door striker.

Expose the adhesive on the foam wire protector next to the sensor and wrap the foam around the frame metal. Connect the door sensor to the blue wire (E) connector.

When you are finished, you can tuck all of the carpeting back in and reinstall the plastic rocker trim. Snapping right into place.



### IMPORTANT

After installing sensors and magnets, only connect one door at a time. Plug your fuse in and make sure the magnet is in the correct location. If it is, the step will deploy when you open the door and retract when you close it. Once you know the door is working, remove the fuse and move onto the next door. If the step does not deploy, you may need to adjust the location of your magnet.

## Step 7

### DOOR MAGNET INSTALLATION

Using the alcohol pad, clean the metal on the inside of the door. Peel off the backing to secure the magnet to the adhesive pad and firmly press the magnet into place.

**REAR DOORS:** Magnet location is on the inner side of the door. Opposite where the sensor was placed on the B Pillar. Remove the clear plastic from the magnet adhesive pad. Adhere it to the magnet by removing the brown paper. Press the sticky sides together. Test fit your location by keeping the blue plastic cover over the adhesive tab. Mark your magnet location and place.

**FRONT DOORS:** Magnet location is on the outer part of the door. Opposite where the sensor was placed below the door striker. Roughly 1/4 in. down from the bottom screw below the door latch.

Rear Door Magnet Placement



Front Door Magnet Placement

### IMPORTANT

Do a test fit to make sure the magnet is properly aligned with the door sensors.

SEE STEP 6 PART 1 & 2





## Step 8

### ROCKER SWITCH INSTALLATION

Follow your driver side door strap to the bracket. Install master switch cutoff bracket onto the JK door strap bracket by loosening the screws and sliding it in place.

Pull the wires through the bracket.

Plug red and black wires into the two prong switch. The wires can be plugged in on either side. Push the button back into the bracket until it snaps into place.

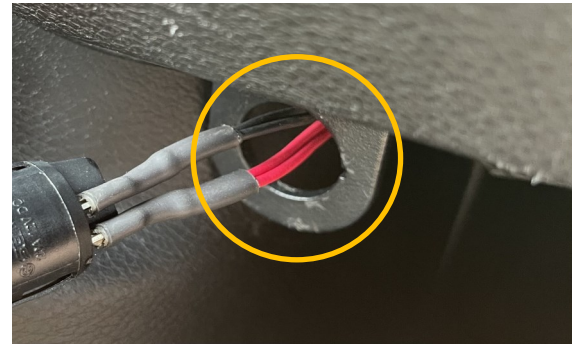

## Step 9

### MECHANICAL INSTALLATION OF THE STEP SLIDERS

Remove two front pinch seam bolts using a 10mm socket and wrench. Leave the holes open.

Keep the hardware as you will re-install it in the final step.

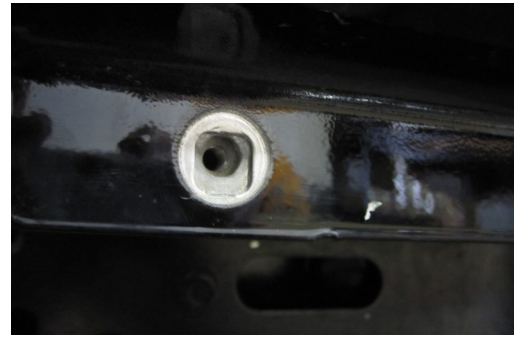

## Step 10

Starting on the passenger side, locate the three body bolts on the underside of the vehicle. Loosen the three body bolts about 1/4" to allow free movement of the washer up and down.

Breaker bar may be required to loosen the body bolts.

### TIP FROM A MECHANIC

As you start loosening, as soon as you hear the bolt pop or feel it bind, reverse direction 1/8 to 1/4 turn to clear the threads. This will make it easier as you progress. Even if you do not hear it pop do the reverse direction early on to prevent body bolt damage.

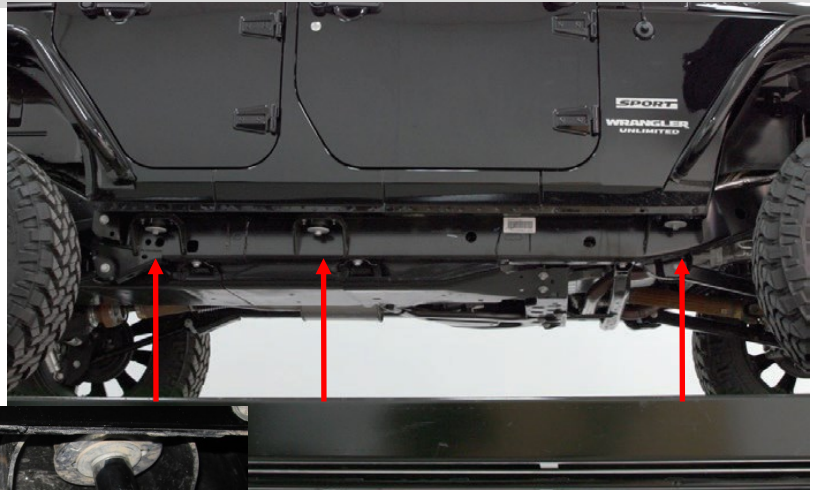

### IMPORTANT

RSE is not responsible for any body bolt damage. Please visit your Jeep dealership or regular mechanic for assistance.

## Step 10

Install each bracket between the bolt head and the washer. Leaving them loose for now.

JK Bracket Identification Mark

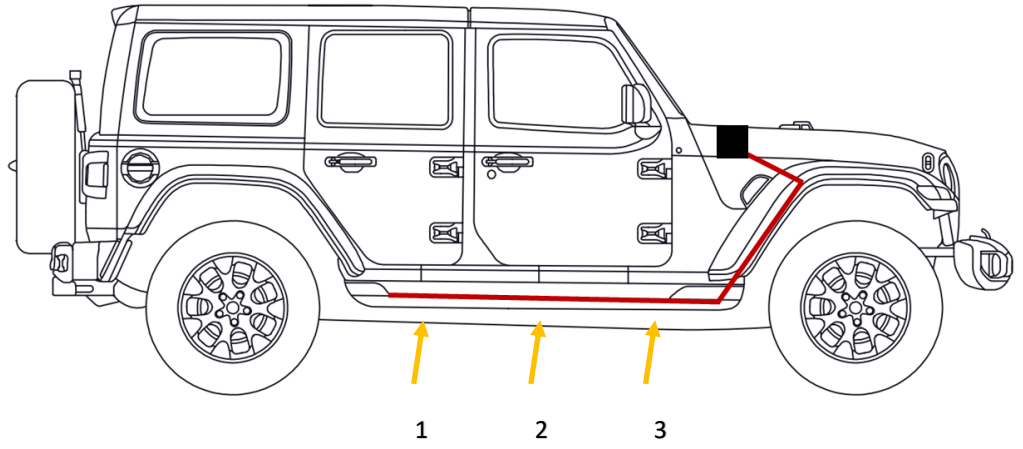
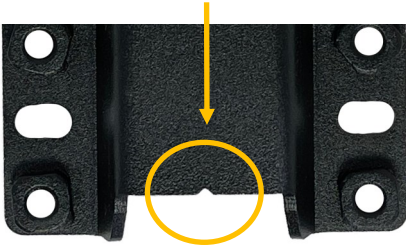

### IMPORTANT

In some cases the washer doesn't allow enough gap you will have to use a small file to remove the two -threads closest to the washer.



### 1. Rear Bracket



5 3/8 in.

### 2. Middle Bracket



4 5/8 in.

### 3. Front Bracket



3 3/8 in.



## Step 11

### BUMP STRAP INSTALLATION

In preparation for the bump straps, make sure the angled section of the Jeeps body near the pinch seam is thoroughly cleaned. Wipe it down with an alcohol pad after.



### IMPORTANT

Before placing the bump strap to the Jeep, do an alignment check. 1 3/4 in. from the bottom of the door seal to the top of the bump strap is a good location.



Take your time with the actual installation. Slowly removing the adhesive as you move along the body of the Jeep, holding the bump strap in place. Press firmly where the tape is removed.



### IMPORTANT

Once that tape adheres to the Jeep, it is designed not to come off. Protecting the Jeeps paint and filling the gap between the Jeep and Step Slider.



## Step 12 - Part 1

### STEP SLIDER INSTALLATION

Starting on the passenger side. Before placing the Step Slider on the Jeep, pull the circuit board (A) and motor connector (B) through the last cutout between the last bolt and the step slider bracket mounting hole. This will make it easy to find your wires and plug in.

When you have the bolts on the step slider inserted into the pinch seam holes, the Step Slider will stay on the Jeep by itself. Secure the Step Slider to the seam by using a 1/4 and 5/16 nyloc nut washer sets.

Plug the circuit board (A) and motor connector (B) into their ports. The additional wire on the harness is for the optional light kit connector (C). Tuck away inside of the step slider for later installation.

Now tighten the pinch seam nuts. 1/4 in. nuts torque 8 ft. lbs. 5/16 nuts torque to 18 ft. lbs.

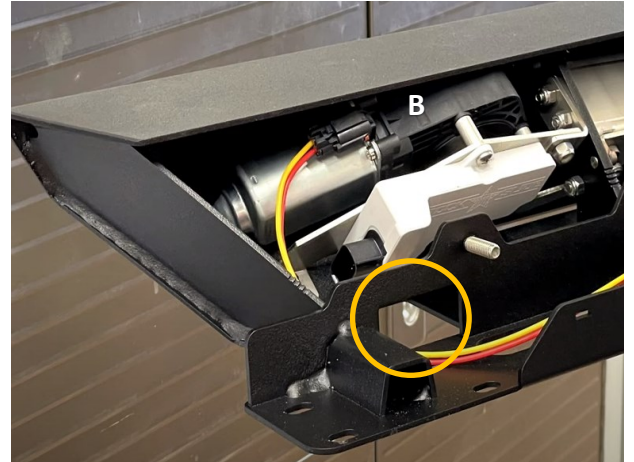
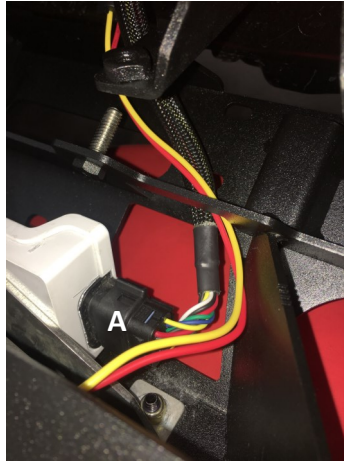

### IMPORTANT

Make sure your wires are not being pinched between the brackets, Step Slider or body of the Jeep.

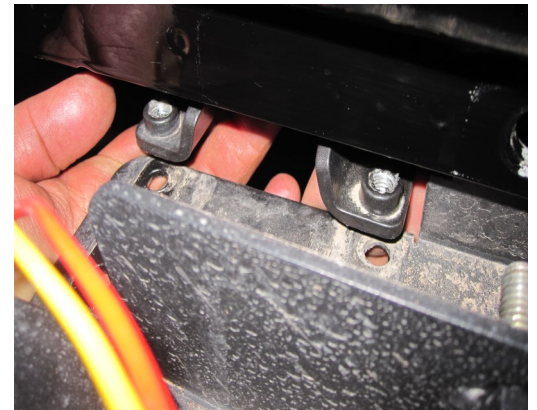

### IMPORTANT

If you are installing the optional skid plate, it mounts in this same place.





## Step 12 - Part 2

Reinstall the two 10 mm. panel pinch bolts.  
Torque these to 8 ft. lbs.



Next, tighten the body bolts. Torque these to 80 ft. lbs.



Repeat this process on the driver side.

## Step 13

### CALABRATION CYCLE

With both of your step sliders installed, it is time to let the circuit board calibrate.

Reinstall the fuse. When you do this, the steps will deploy and retract rapidly. This is normal.

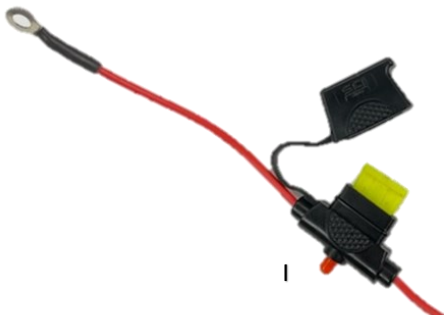

### IMPORTANT

Make sure there is nothing that will stop the step from deploying and retracting fully. If something has blocked your step, remove the fuse again and re-run the calibration cycle.

#### Step 14

Use these plugs to cover the holes in the Step Slider.



**You are done!**

**Scan this code to leave us a review!**



See our FAQ on the next page for any troubleshooting or give us a call!





## FREQUENTLY ASKED QUESTIONS:

<p><b>I just installed my steps and they are not coming down when I open the door.</b></p>	<p>Double check the connections. Check the fuse to make sure it is plugged in. Is the on / off switch getting power? Is the circuit board plugged in? Are the door sensors plugged in?</p>
<p><b>My rocker switch is getting power, but the light stays on in both positions.</b></p>	<p>The light is only supposed to be on when the system is turned on. If it is lit in both positions simply switch the red wires on the back. Will this kill my battery with the light constantly lit? This will not kill your battery unless you leave it lit for a month with no use.</p>
<p><b>Everything is plugged in and the switch is turning on and off, but the steps still won't deploy.</b></p>	<p>Check the motor first. Simply unplug it from the wiring harness and apply external 12V power to the leads. One position will make them deploy. Switch the leads again to make them retract. If this works, plug the motor back into the harness. We test each and every motor that leaves our factory by hand along with assembling your step slider by hand. These may fail, but it is extremely rare after we send them after having tested them. If you test the motor and all you hear is a clicking sound but nothing happens, there is likely internal damage.</p>
<p><b>I tested the motor, and it works. I checked the sensors individually, and the system still won't work. The steps don't deploy unless I do it manually with 12V power.</b></p>	<p>In rare circumstances, the circuit board that runs the system may be faulty.  Send us an email at <a href="mailto:Warranty@rockslideengineering.com">Warranty@rockslideengineering.com</a> to request a new circuit board.</p>
<p><b>I opened my door a bunch of times and the system just shut off. What happened?</b></p>	<p>Our systems have built-in protection against quick cycling like this to prevent damage. Simply remove your 20 volt fuse and re-install. This will reset the system and allow it to work normally again.</p>
<p><b>Everything is working now. But I want to take my doors off and have the steps still work.</b></p>	<p>We sell a door delete kit you can replace those sensors with. Part# SL-DD-100 comes with everything you need for two doors. If you want to install a delete kit on the rear doors as well, you will need to purchase two kits.</p>
<p><b>The steps deployed and won't retract. What is going on?</b></p>	<p>Chances are your magnets are misaligned. To diagnose which door needs to be adjusted, unplug the rear sensors with the front doors closed. If your steps come up, then it was the rear doors that need to be aligned with your magnet. If the step stays down, the front door needs to be aligned. Open your door, shift the magnet in a direction, and shut it again. Repeat until the step comes up when the door is shut. Mark the magnet placement on the front door. Plug the rear door sensor in, shut the rear door and front door, and see if it comes up. If not, the rear door is misaligned (Since we just aligned the front door we know it's the rear door now). Repeat the previous process of opening your door, shifting your magnet, and shutting your door until the step comes up. It may take a few tries.</p> <p>OPTION 2</p> <p>Check the sensors. Unplug both of them from the wiring harness on the side that is not working, and plug one back in. Manually test your sensors by putting a magnet really close (but not touching) to the sensor. Does it make the step retract? When the magnet is away, the step should deploy. If the steps deploy right after installation, more than likely your magnets just need to be aligned. Do this one by one with each sensor by the method above. Install one sensor, test, align the magnet on the door, test, and then mark the position of the magnet so if for some reason they do move out of place you can easily realign them.</p>
<p><b>I was off-roading, left my system on, someone left the door ajar and I ripped my step off on a rock. What now?</b></p>	<p>We can replace these parts for you at cost. You will have to remove the step off your vehicle to replace the innards. Call us and we'll figure out what you need exactly! If you prefer us to do the repair we will do that for you! You will have to cover shipping to us and the cost of the parts, but we will ship it back to you (from our warehouse to your house) on our account.</p>

# WARRANTY POLICY

## LIMITED TWELVE (12) MONTH WARRANTY FOR FINISH AND ELECTRICAL COMPONENTS

Rock-Slide Engineering, LLC (“RSE”) warrants to the original purchaser that (a) the structural and mechanical components of the Step Sliders will be free of defects in material and workmanship for the lifetime of the Step Sliders (the “product”), and (b) the finish (powder coat) and the electrical components (including the motor) will be free of defects in material and workmanship for a period of twelve (12) months from the original date of purchase. This warranty applies only to the original retail purchaser. Warranty is void if product was not purchased directly from R- SE or from an authorized RSE retailer or reseller. This warranty applies only with regard to the product as originally installed to the original vehicle. This warranty does not cover removal or reinstallation of the product.

To exercise this warranty and receive any warranty service, the original purchaser must provide RSE with proof of purchase and date of purchase that is acceptable to RSE, such as a copy of the original purchaser’s purchase receipt. The original purchaser must return the defective product to RSE along with a description of the problem, a copy of the original purchase receipt, the original bill of sale and all contact information (name, address, telephone number and email address). To begin the warranty process, the original purchaser must email RSE’s warranty department. During this warranty term, and upon the original purchaser’s valid exercise of this warranty, RSE shall, at its option, repair or furnish the replacement product in the event the original product is deemed by RSE to be defective. RSE’s sole liability shall be for repairing or replacing the product, but RSE may refund the purchase price at its sole discretion and option. The original purchaser is responsible for prepayment of all shipping and/or transportation charges with respect to the exercise of this warranty. The product may change without notice. In the event of a product change, RSE has no obligation to upgrade or modify any older generation product.

THE WARRANTY SET FORTH HEREIN IS THE ONLY WARRANTY COVERING THE PRODUCT. NO OTHER WARRANTY EXISTS, EXPRESS OR IMPLIED, INCLUDING, WITHOUT LIMITATION, IMPLIED WARRANTIES OF MERCHANTABILITY AND/OR FITNESS FOR A PARTICULAR PURPOSE. No retailer, reseller, dealer, agent, or employee is authorized to make any modifications, extensions, amendments, or additions to this warranty.

This warranty shall be void in its entirety if RSE determines that the product installation was modified, changed, altered, customized or in any way used other than as instructed. Installation of the product without strictly adhering to the installation instructions shall void this warranty. Installation must be on the proper vehicle or warranty is void.

RSE SHALL NOT BE LIABLE FOR SPECIAL, INDIRECT, INCIDENTAL OR CONSEQUENTIAL DAMAGES, UNDER ANY LEGAL THEORY AND/OR UNDER ANY CIRCUMSTANCE WHATSOEVER. IN ANY EVENT, ANY DAMAGES IN ANY SITUATION SHALL BE LIQUIDATED DAMAGES AND MAY NOT EXCEED THE RETAIL PRICE OF THE PRODUCT. RSE SHALL NOT BE LIABLE FOR ANY LOSS, DAMAGE OR INJURY DIRECTLY OR INDIRECTLY ARISING FROM THE USE OF OR INABILITY TO DETERMINE THE USE OF THE PRODUCT. THE ORIGINAL PURCHASER IS RESPONSIBLE TO DETERMINE THE SUITABILITY OF THE PRODUCT FOR ITS INTENDED USE, PRIOR TO USING THE PRODUCT, AND THE ORIGINAL PURCHASER ASSUMES ALL RESPONSIBILITY AND RISK IN CONNECTION THEREWITH.

For questions or concerns: please contact our office at 435-752-4580 and ask for the warranty department or email us at [warranty@rockslideengineering.com](mailto:warranty@rockslideengineering.com).



**MADE IN THE USA**

# GENERAL MAINTENANCE MANUAL

To ensure your Step Sliders function properly, some maintenance is required!  
Properly clean and lubricate your Step Sliders after any off-road adventure and frequently during winter months.



Deploy the steps to pressure wash the body of the Step Slider and the internals.  
Apply a multipurpose lubricant in each of the pivot joints, and a dry Teflon lubricant spray on the spring when clean.



**Here are some lubrication options you can find in your local stores!**