

**CHUBBY
GORILLA**

UNICORN BOTTLE®

SKU: CGUB1-10MLV3

LABEL SIZE SUGGESTION:

inch | 2.6" W x 1.125" H

mm | 66.04 mm W x 28.57 mm H

CAPACITY:

10 mL

0.34 oz.

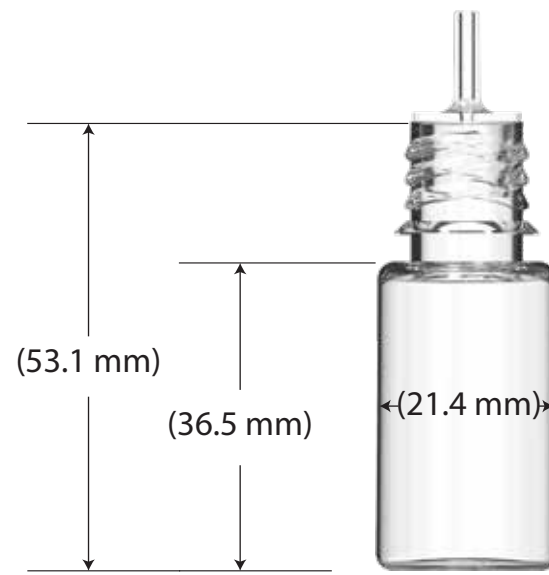

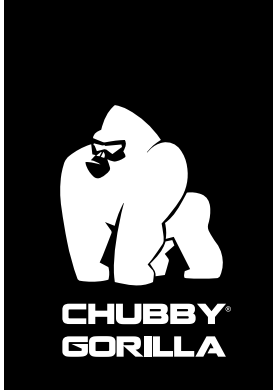

UNICORN BOTTLE®

SKU: CGUB1-10MLV3

LABEL SIZE SUGGESTION: **inch** | 2.6" W x 1.125" H **mm** | 66.04 mm W x 28.57 mm H

CAPACITY: 10 mL 0.34 oz

--- Safe area
— Trim
— Bleed

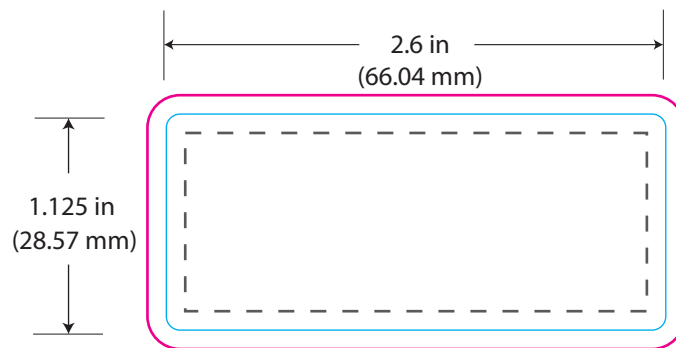

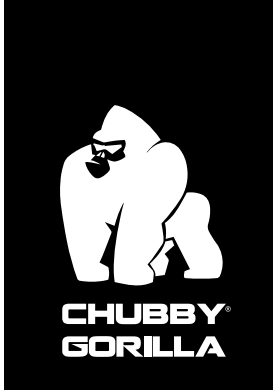

UNICORN BOTTLE®

SKU: CGUB1-15MLV3

LABEL SIZE SUGGESTION:

inch | 2.6" W x 1.8" H

mm | 66 mm W x 45.72 mm H

CAPACITY:

16.5 mL

0.56 oz.

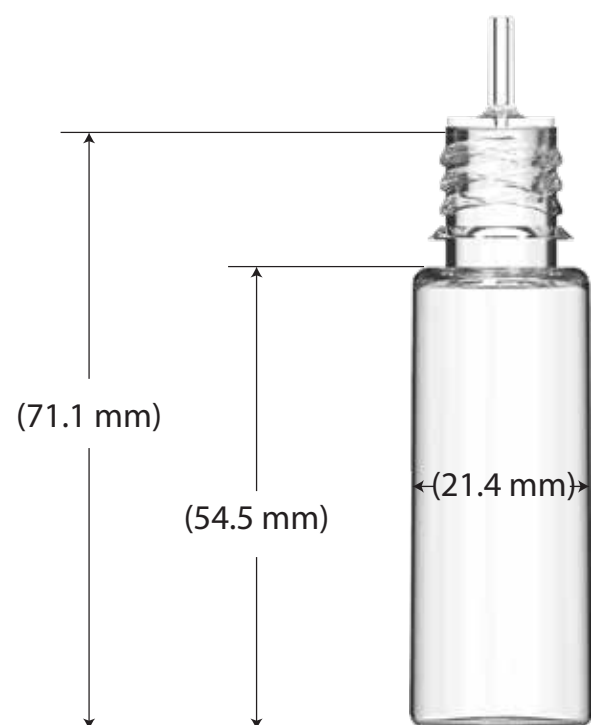

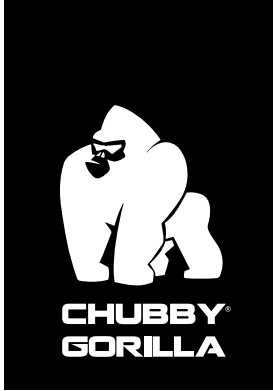

UNICORN BOTTLE®

SKU: CGUB1-15MLV3

LABEL SIZE SUGGESTION: **inch** | 2.6" W x 1.8" H **mm** | 66 mm W x 45.72 mm H

CAPACITY: 16.5 mL. 0.56 oz.

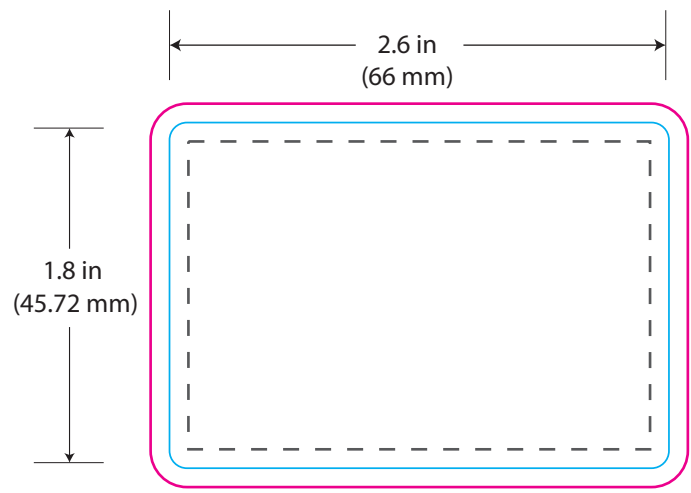
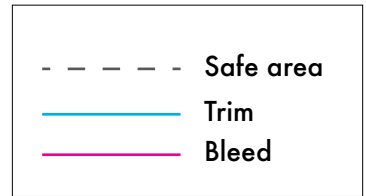



UNICORN BOTTLE®

SKU: CGUB1-20MLV3

LABEL SIZE SUGGESTION:

inch | 2.6" W x 2.1" H

mm | 66 mm W x 53.34 mm H

CAPACITY:

20 mL

0.68 oz.

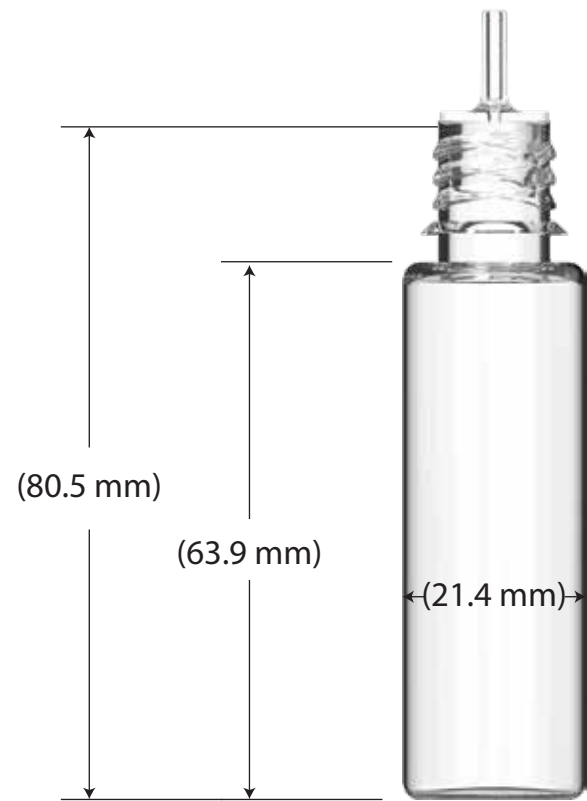

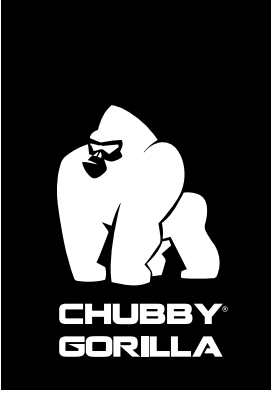

UNICORN BOTTLE®

SKU: CGUB1-20MLV3

LABEL SIZE SUGGESTION: **inch** | 2.6" W x 2.1" H **mm** | 66 mm W x 53.34 mm H

CAPACITY: 20 mL 0.68 oz

--- Safe area
— Trim
— Bleed

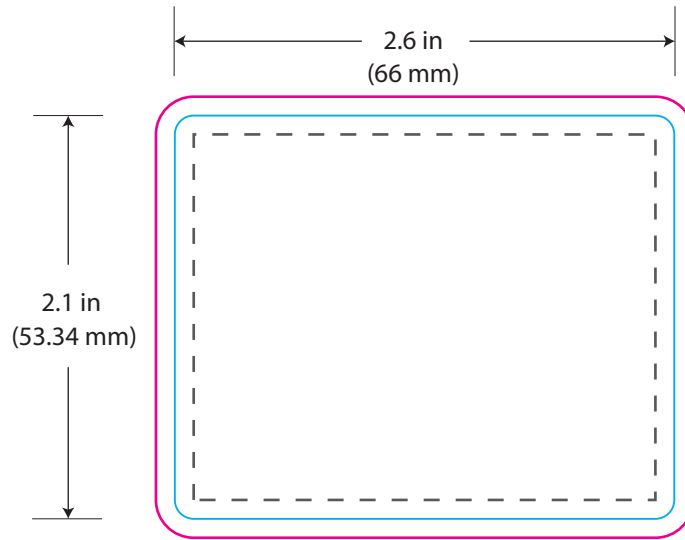

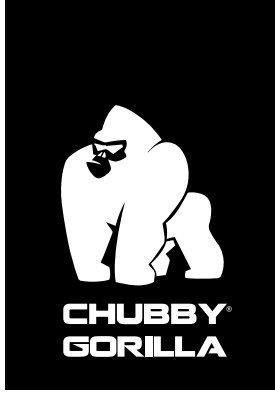

UNICORN BOTTLE®

SKU: CGUB1-20MLSC

LABEL SIZE SUGGESTION:

inch

3.62" W x 1.08" H

mm

92 mm W x 27.5 mm H

CAPACITY:

20 mL

0.68 oz.

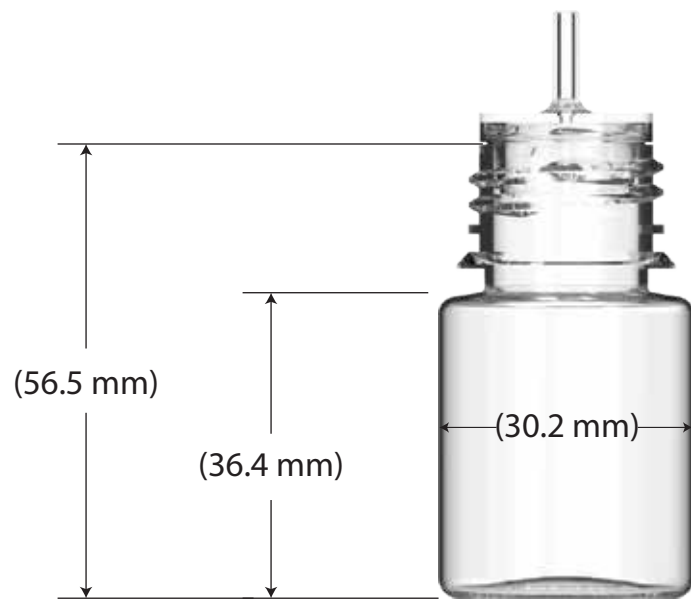

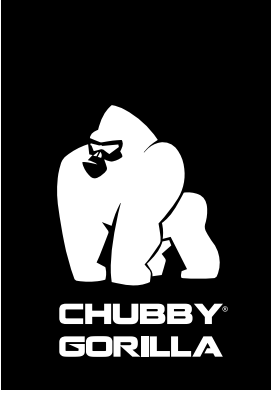

UNICORN BOTTLE®

SKU: CGUB1-20MLSC

LABEL SIZE SUGGESTION: **inch** | 3.62" W x 1.08" H **mm** | 92 mm W x 27.5 mm H

CAPACITY: 20 mL 0.68 oz.

--- Safe area
— Trim
— Bleed

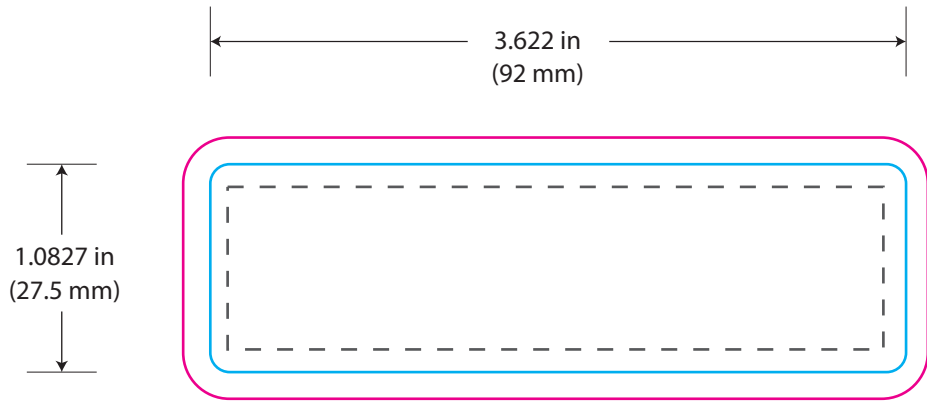

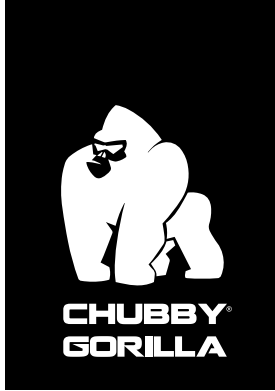

UNICORN BOTTLE®

SKU: CGUB1-30MLSC

LABEL SIZE SUGGESTION:

inch | 3.65" W x 1.6" H

mm | 92.71 mm W x 40.64 mm H

CAPACITY:

30 mL

1.01 oz.





UNICORN BOTTLE®

SKU: CGUB1-30MLSC

LABEL SIZE SUGGESTION: **inch** | 3.65" W x 1.6" H **mm** | 92.71 mm W x 40.64 mm H

CAPACITY: 30 mL 1.01 oz.

--- Safe area
— Trim
— Bleed

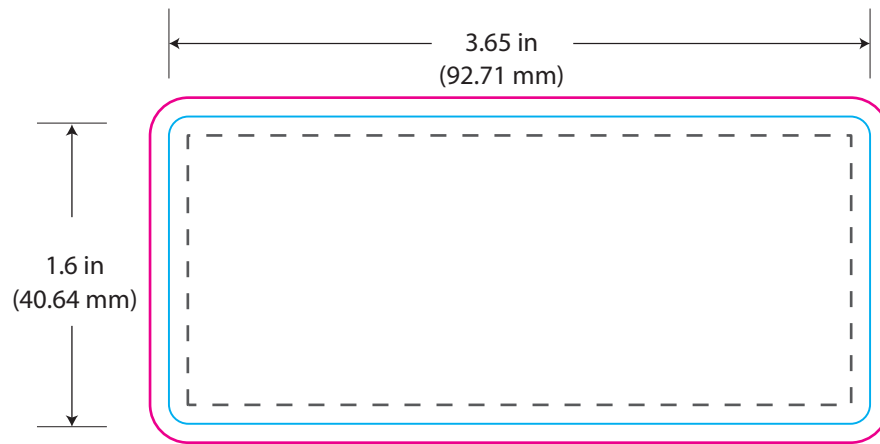

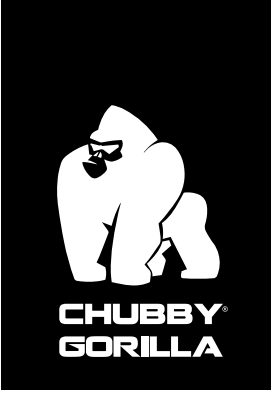

UNICORN BOTTLE®

SKU: CGUB1-30MLV3

LABEL SIZE SUGGESTION: **inch** | 2.6" W x 3.25" H **mm** | 66.04 mm W x 82.55 mm H

CAPACITY: 30 mL 1.01 oz.

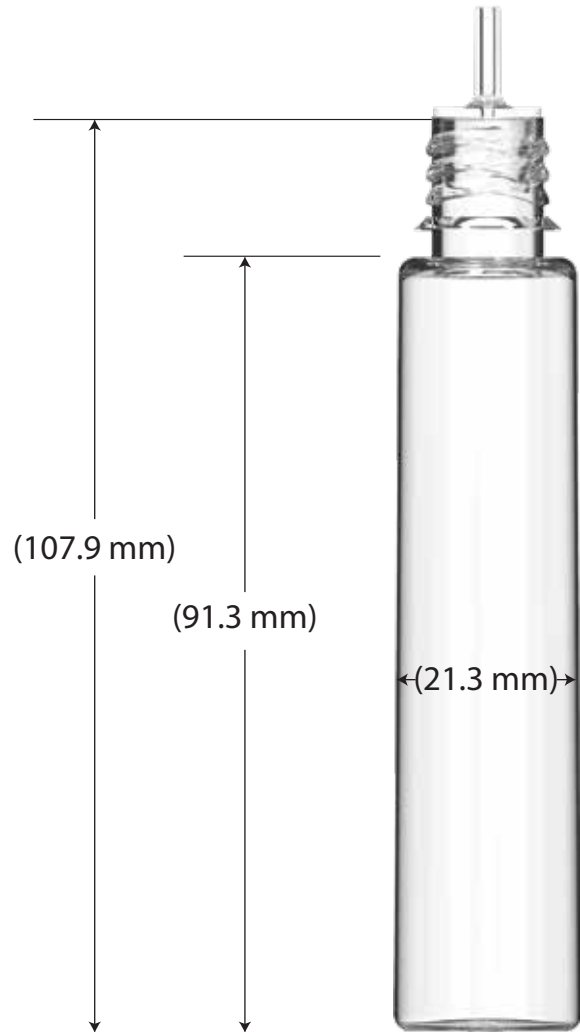
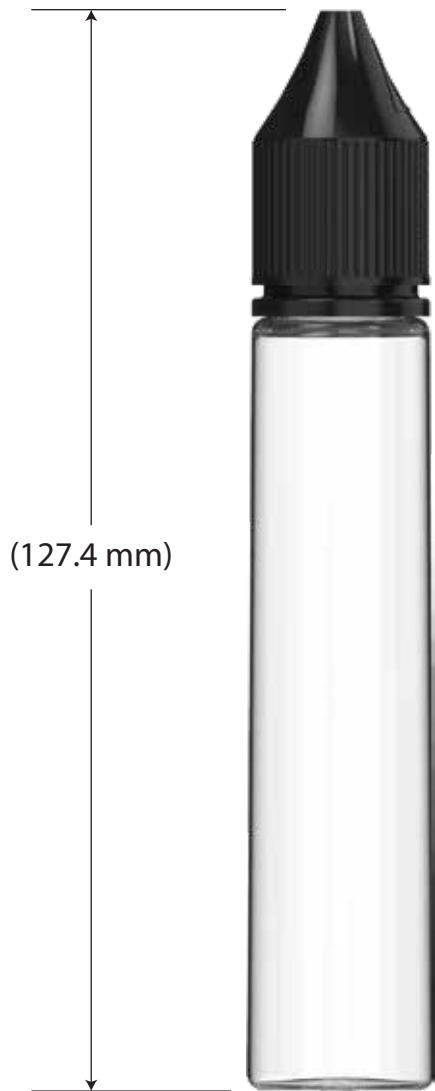



UNICORN BOTTLE®

SKU: CGUB1-30MLV3

LABEL SIZE SUGGESTION: **inch** | 2.6" W x 3.25" H **mm** | 66.04 mm W x 82.55 mm H

CAPACITY: 30 mL 1.01 oz.

- - - - -	Safe area
— (blue)	Trim
— (pink)	Bleed

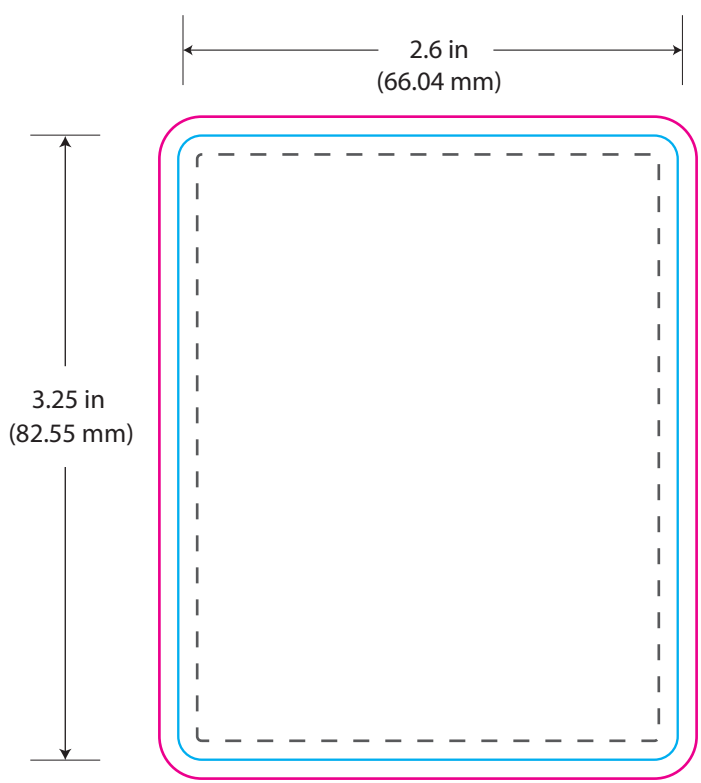

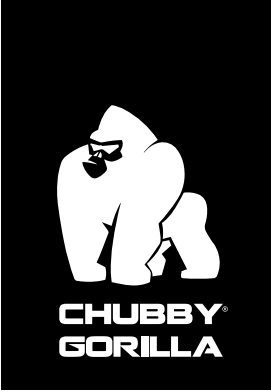

UNICORN BOTTLE®

SKU: CGUB1-50MLV3

LABEL SIZE SUGGESTION:

inch | 3.65" W x 2.75" H

mm | 92.71 mm W x 69.85 mm H

CAPACITY:

50 mL

1.69 oz.

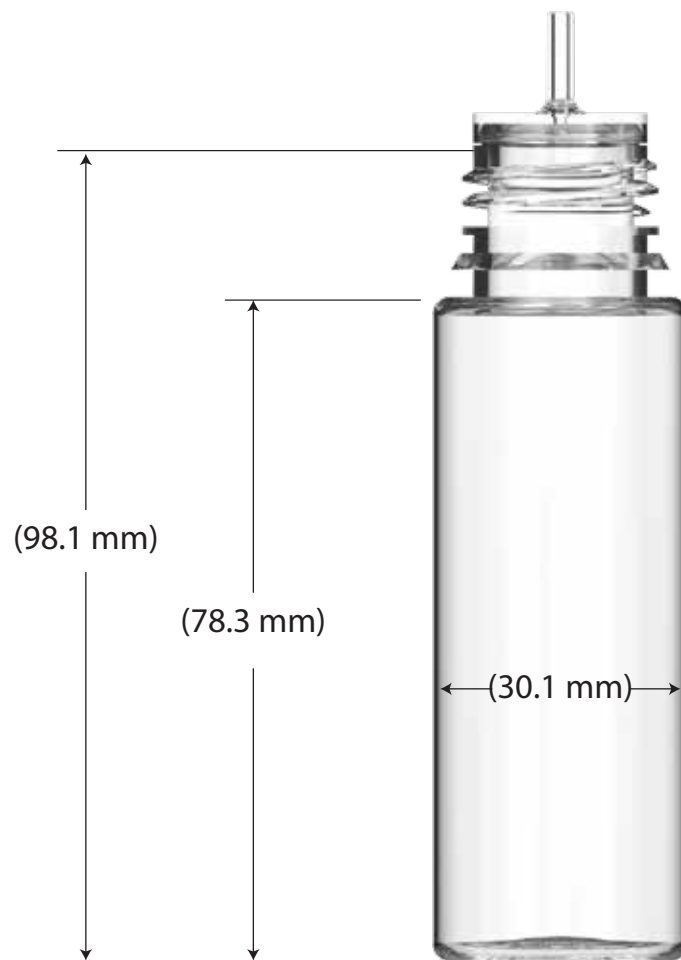

UNICORN BOTTLE®

CGUB1-50MLV3

Label guide →

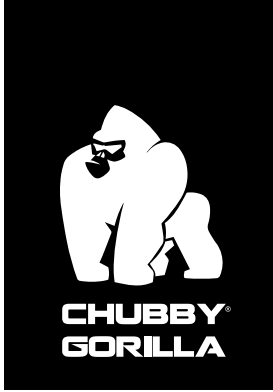

UNICORN BOTTLE®

SKU: CGUB1-50MLV3

LABEL SIZE SUGGESTION: **inch** | 3.65" W x 2.75" H **mm** | 92.71 mm W x 69.85 mm H

CAPACITY: 50 mL 1.69 oz.

--- Safe area
— Trim
— Bleed

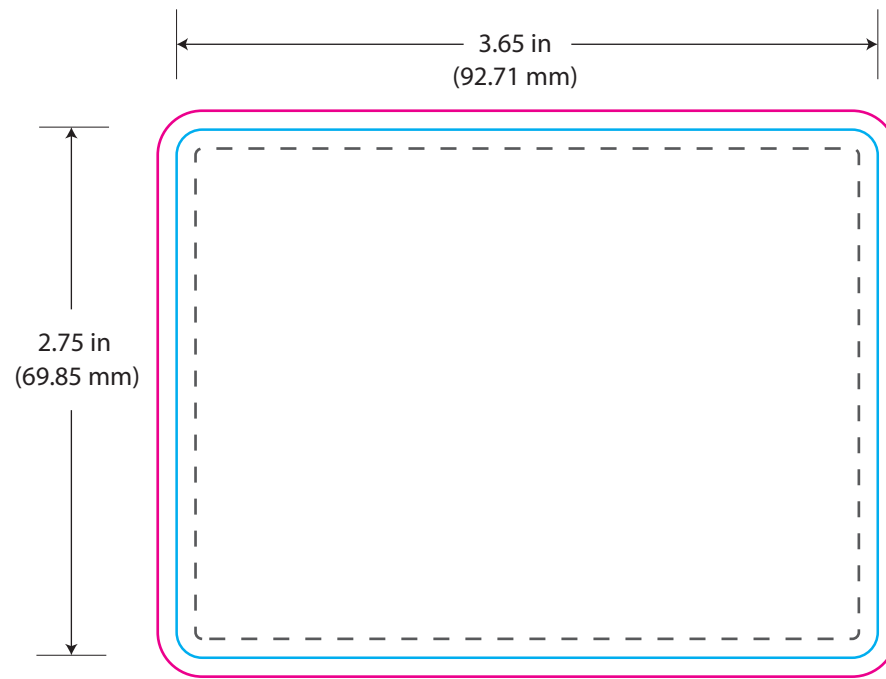

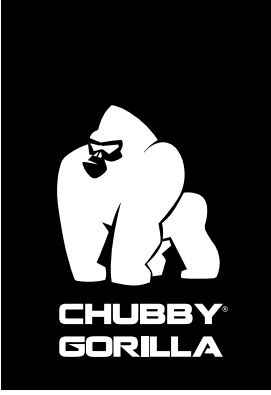

UNICORN BOTTLE®

SKU: CGUB1-60MLV3

LABEL SIZE SUGGESTION:

inch | 3.65" W x 3.25" H

mm | 92.71 mm W x 82.55 mm H

CAPACITY:

60 mL

2.03 oz.

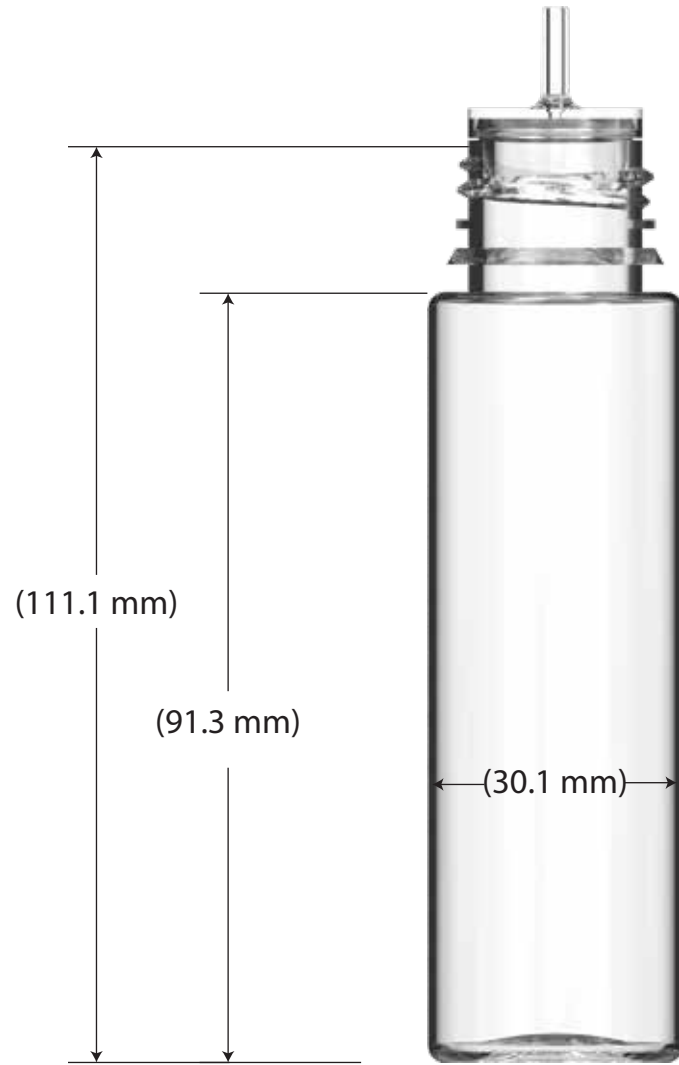

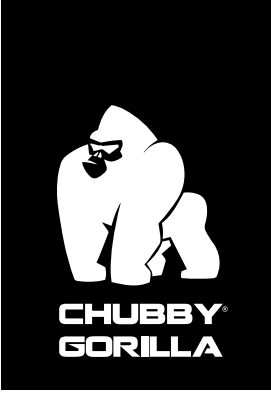

UNICORN BOTTLE®

SKU: CGUB1-60MLV3

LABEL SIZE SUGGESTION: **inch** | 3.65" W x 3.25" H **mm** | 92.71 mm W x 82.55 mm H

CAPACITY: 60 mL 2.03 oz.

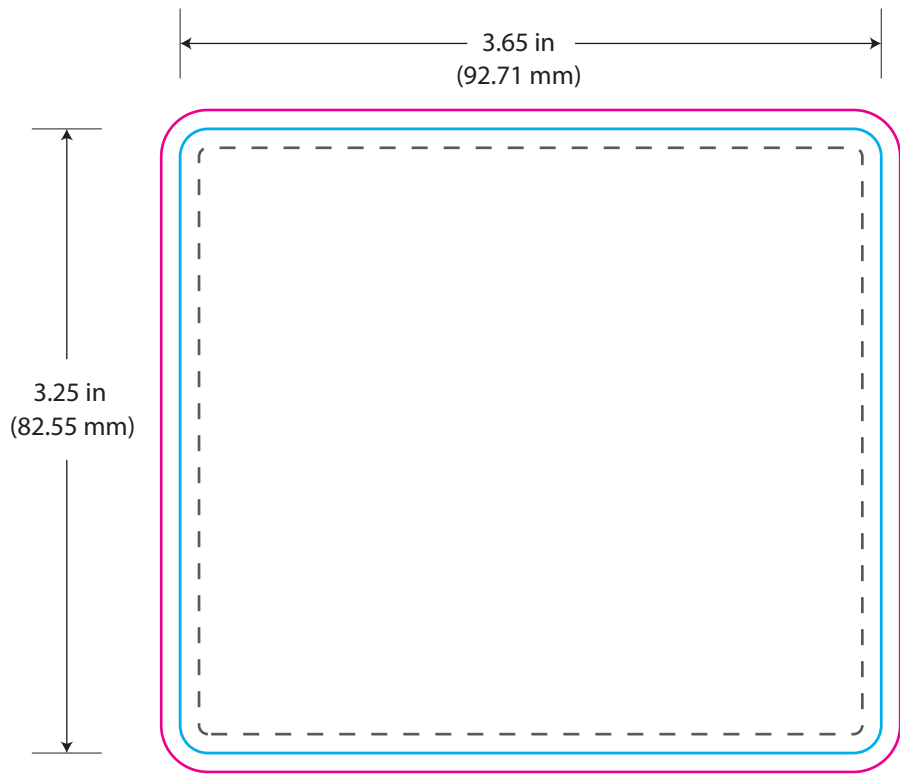
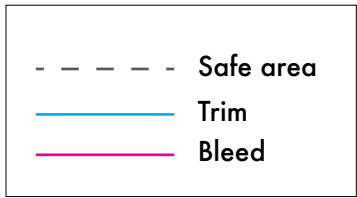

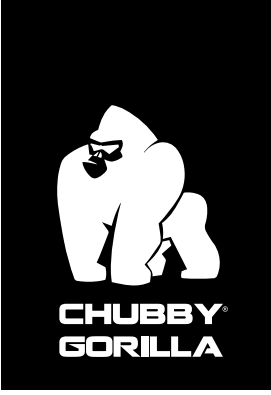

UNICORN BOTTLE®

SKU: CGUB1-60MLSC

LABEL SIZE SUGGESTION:

inch | 5" W x 1.5" H

mm | 127 mm W x 40 mm H

CAPACITY:

60 mL

2.03 oz.

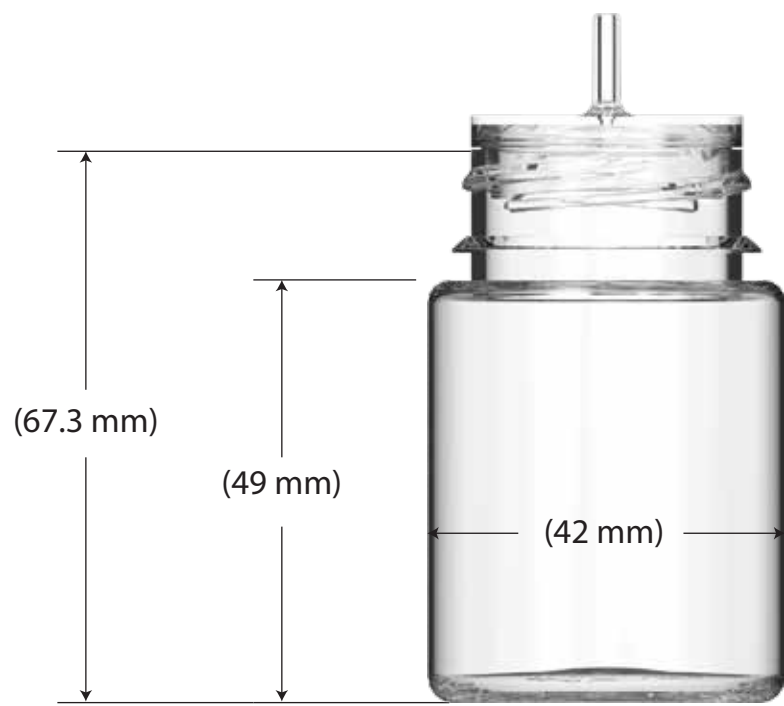

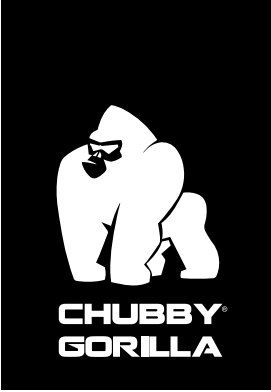

UNICORN BOTTLE®

SKU: CGUB1-60MLSC

LABEL SIZE SUGGESTION:

inch | 5" W x 1.5" H

mm | 127 mm W x 40 mm H

CAPACITY:

60 mL

2.03 oz.

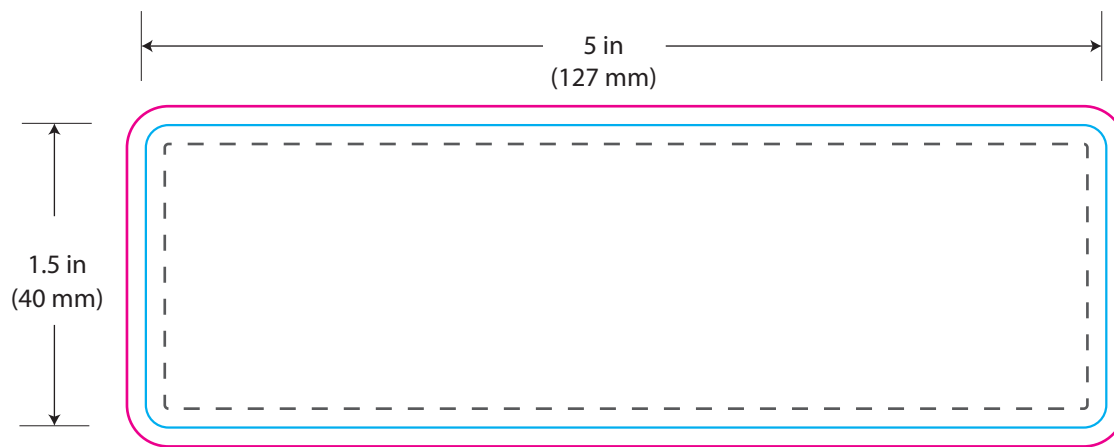
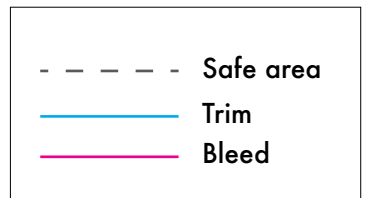



UNICORN BOTTLE®

SKU: CGUB1-60MLM

LABEL SIZE SUGGESTION:

inch | 4.4" W x 1.9" H

mm | 117 mm W x 48 mm H

CAPACITY:

60 mL

2.03 oz.

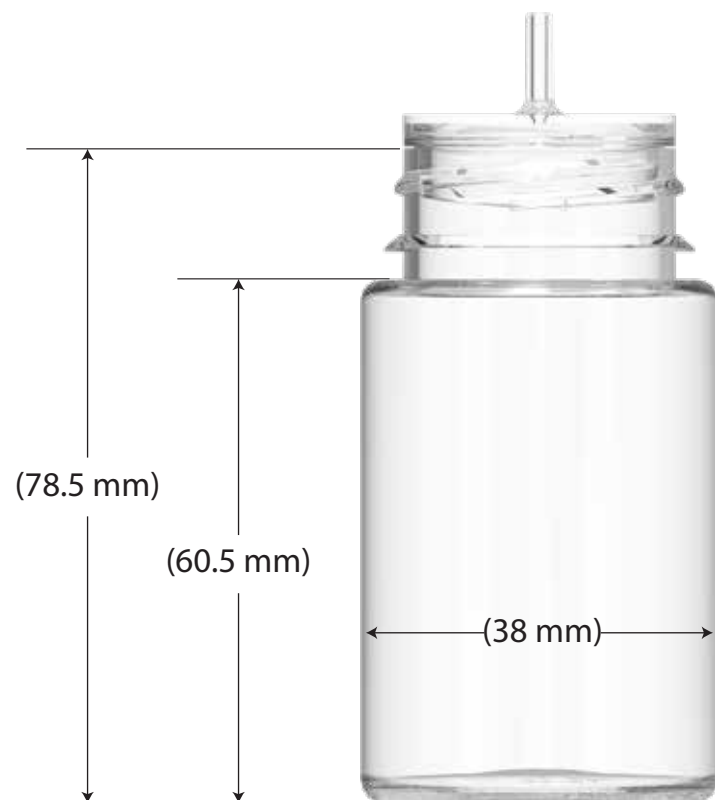



UNICORN BOTTLE®

SKU: CGUB1-60MLM

LABEL SIZE SUGGESTION: **inch** | 4.4" W x 1.9" H **mm** | 117 mm W x 48 mm H

CAPACITY: 60 mL 2.03 oz.

--- Safe area
— Trim
— Bleed

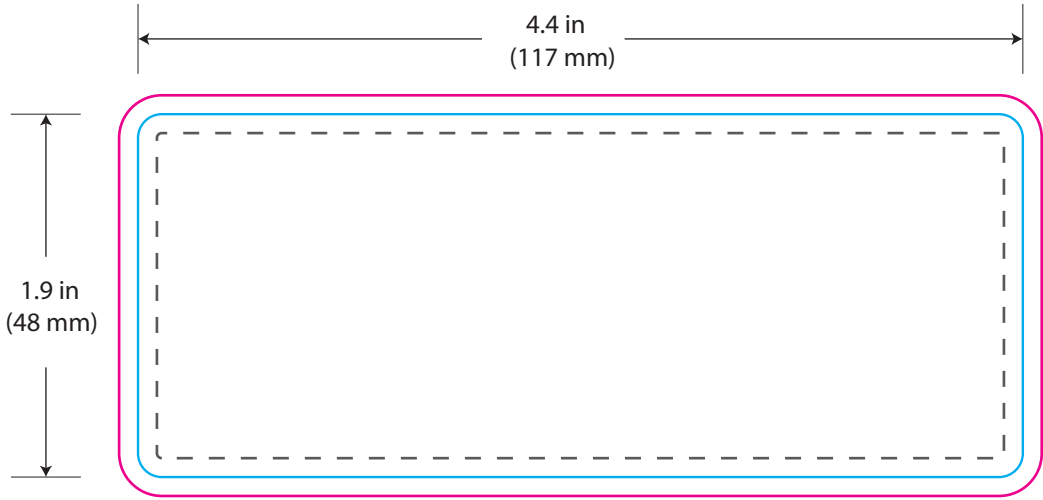



UNICORN BOTTLE®

SKU: CGUB1-75MLSC

LABEL SIZE SUGGESTION:

inch | 5" W x 2.2" H

mm | 127 mm W x 55.88 mm H

CAPACITY:

75 mL

2.54 oz.



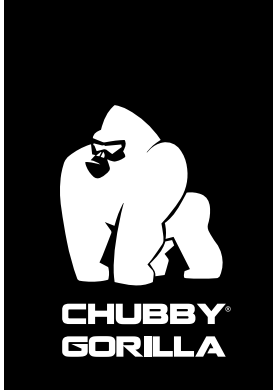

UNICORN BOTTLE®

SKU: CGUB1-75MLSC

LABEL SIZE SUGGESTION:

inch | 5" W x 2.2" H

mm | 127 mm W x 55.88 mm H

CAPACITY:

75 mL

2.54 oz.

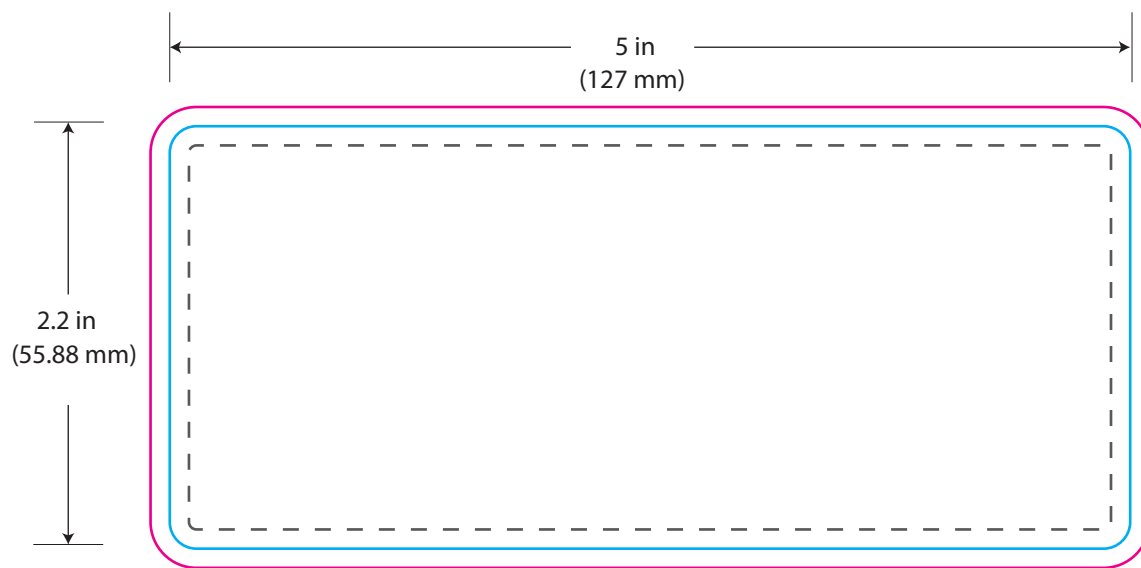
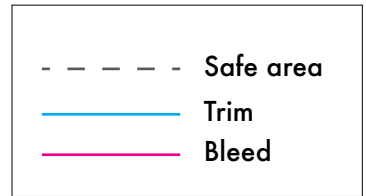

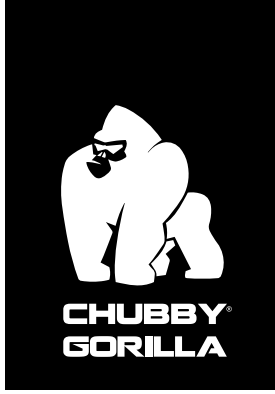

UNICORN BOTTLE®

SKU: CGUB1-75MLV3

LABEL SIZE SUGGESTION: **inch** | 3.62" W x 4.09" H **mm** | 92 mm W x 104 mm H

CAPACITY: 75 mL 2.54 oz.

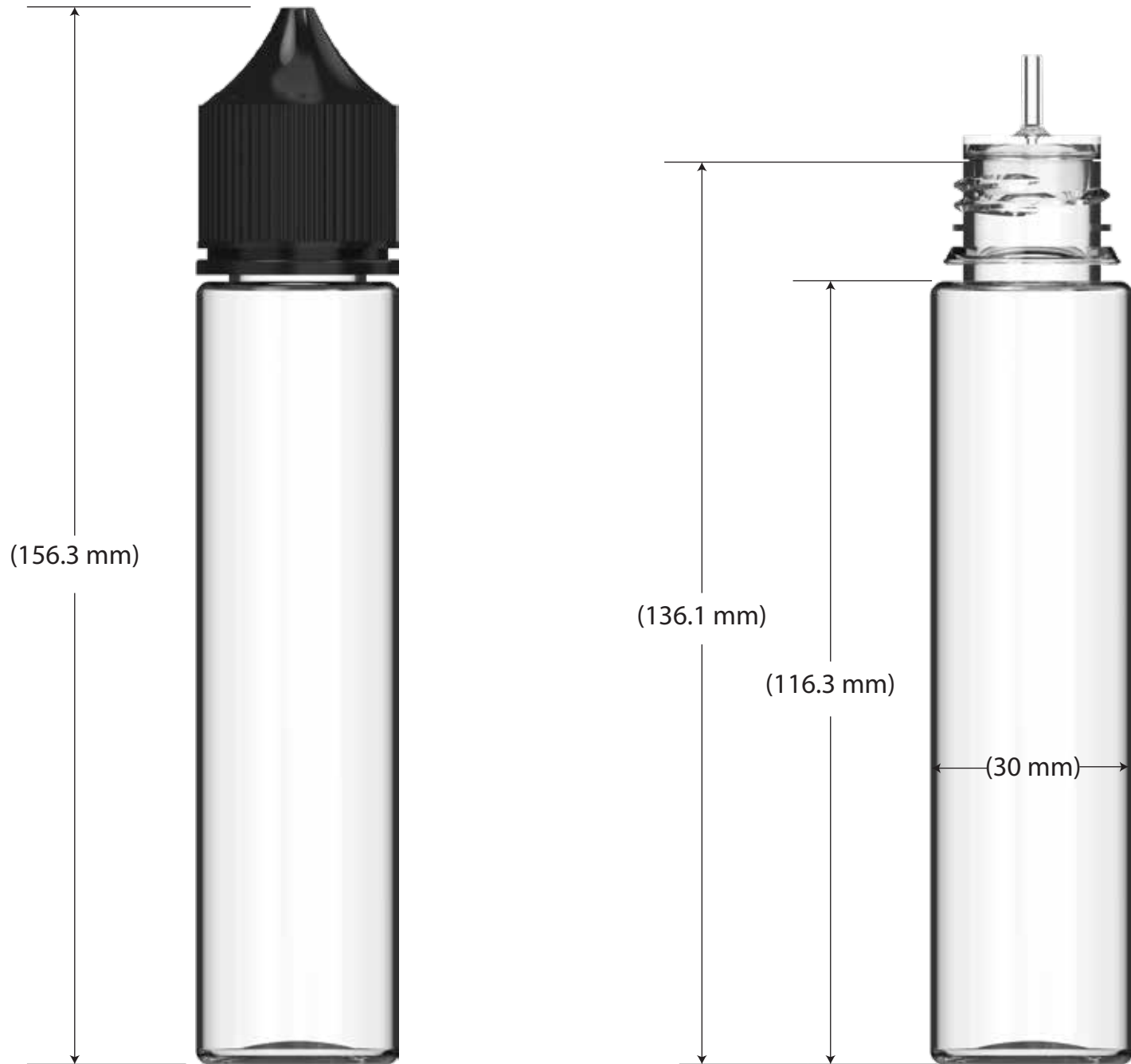

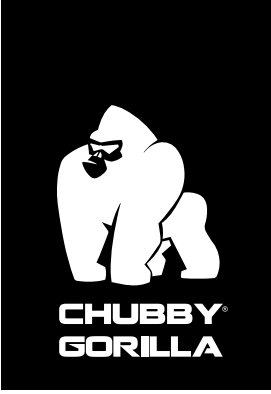

UNICORN BOTTLE®

SKU: CGUB1-75MLV3

LABEL SIZE SUGGESTION: **inch** | 3.62" W x 4.09" H **mm** | 92 mm W x 104 mm H

CAPACITY: 75 mL 2.54 oz.

--- Safe area
— Trim
— Bleed

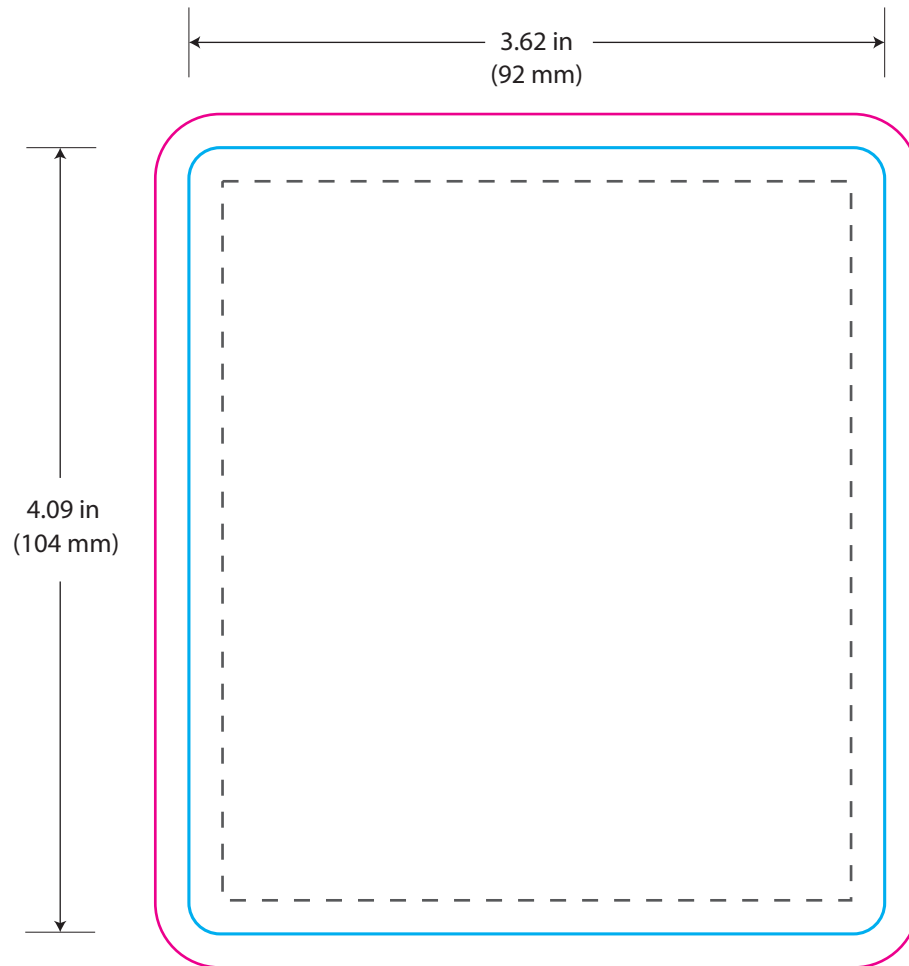



UNICORN BOTTLE®

SKU: CGUB1-75MLM

LABEL SIZE SUGGESTION:

inch | 4.4" W x 2.44" H

mm | 112 mm W x 62 mm H

CAPACITY:

75 mL

2.54 oz.



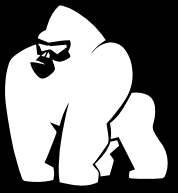

**CHUBBY
GORILLA**

UNICORN BOTTLE®

SKU: CGUB1-75MLM

LABEL SIZE SUGGESTION:

inch | 4.4" W x 2.44" H

mm | 112 mm W x 62 mm H

CAPACITY:

75 mL

2.54 oz.

- - - - - Safe area
— Trim
— Bleed

4.4 in
(112 mm)

2.44 in
(62 mm)



UNICORN BOTTLE®

CGUB1-75MLM

75 mL

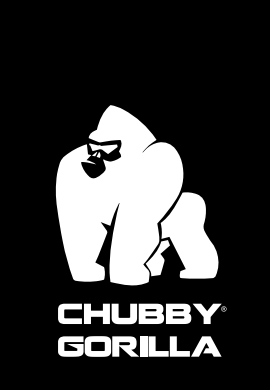

UNICORN BOTTLE®

SKU: CGUB1-100MLV3

LABEL SIZE SUGGESTION:

inch | 5" W x 2.75" H

mm | 127 mm W x 70 mm H

CAPACITY:

100 mL

3.38 oz.

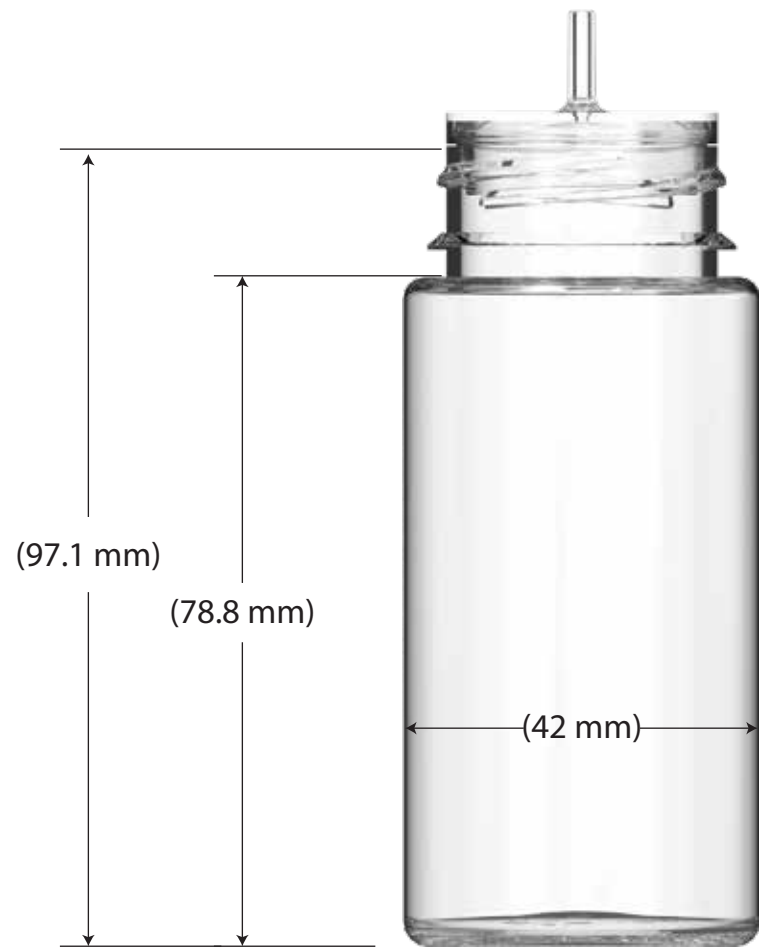



UNICORN BOTTLE®

SKU: CGUB1-100MLV3

LABEL SIZE SUGGESTION:

inch | 5" W x 2.75" H

mm | 127 mm W x 70 mm H

CAPACITY:

100 mL.

3.38 oz.

- - - - - Safe area
— Trim
— Bleed

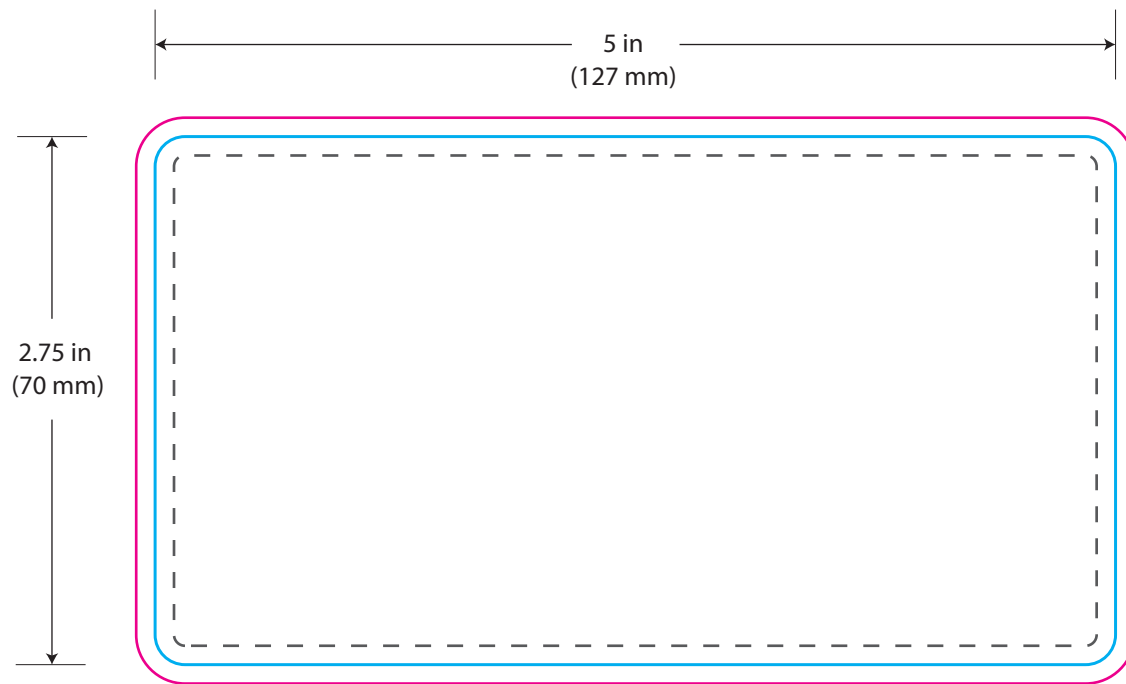



UNICORN BOTTLE®

SKU: CGUB1-120MLV3

LABEL SIZE SUGGESTION:

inch | 5" W x 3.25" H

mm | 127 mm W x 82.55 mm H

CAPACITY:

120 mL

4.06 oz.

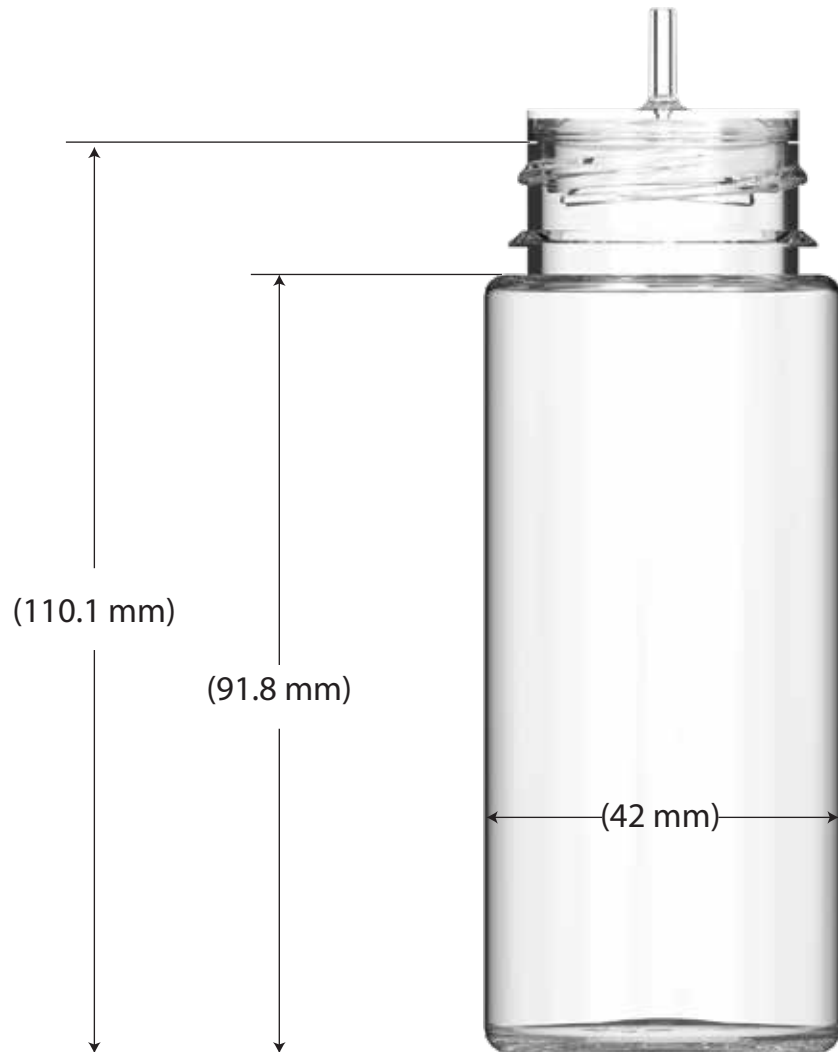

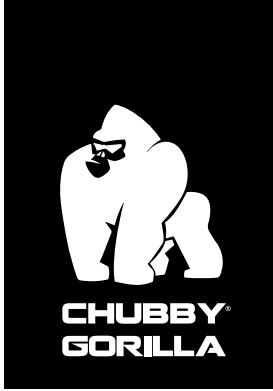

UNICORN BOTTLE®

SKU: CGUB1-120MLV3

LABEL SIZE SUGGESTION: **inch** | 5" W x 3.25" H **mm** | 127 mm W x 82.55 mm H

CAPACITY: 120 mL 4.06 oz.

--- Safe area
— Trim
— Bleed

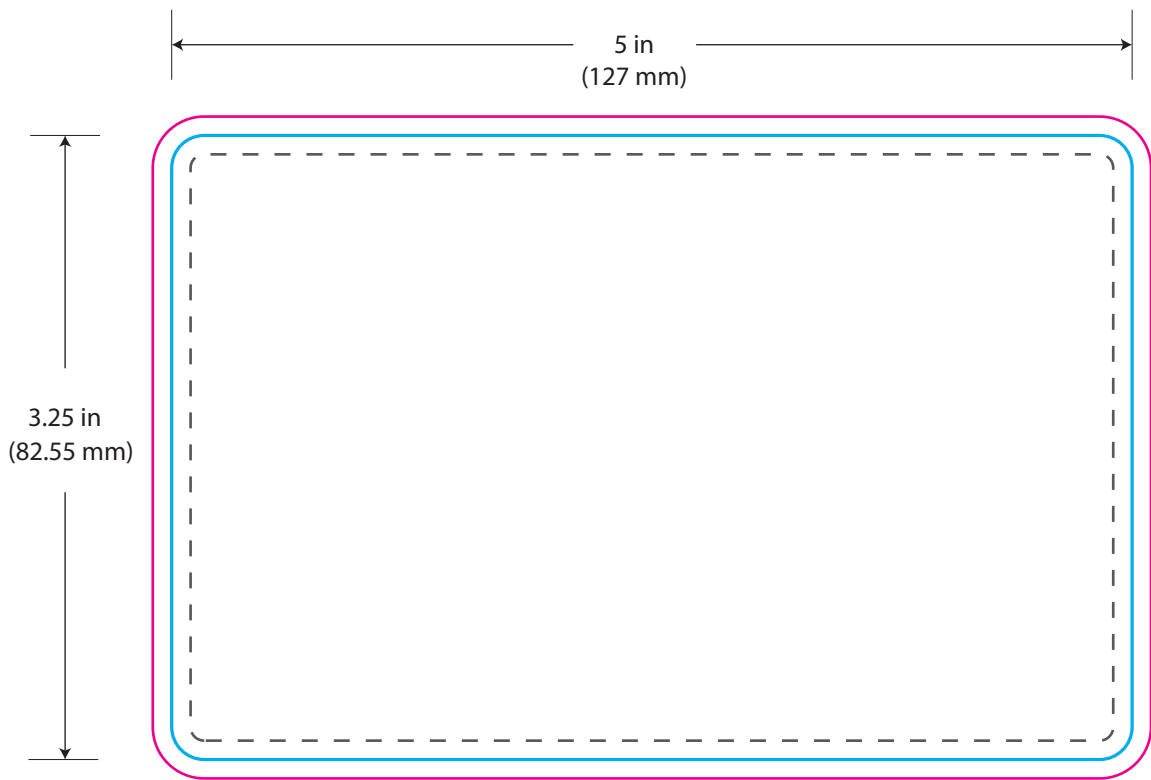

UNICORN® BOTTLE REDUCER

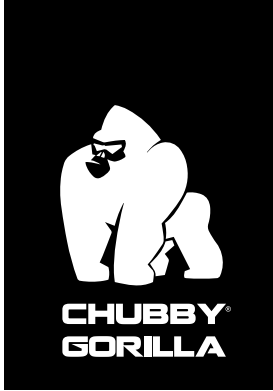

UNICORN BOTTLE® REDUCER **SKU: CGUB1-10MLR**

LABEL SIZE SUGGESTION: **inch** | 2.6" W x 1.125" H **mm** | 66.04 mm W x 28.57 mm H

CAPACITY: 10 mL 0.34 oz

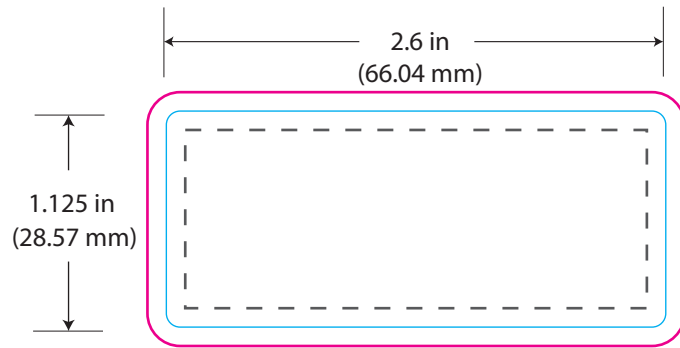
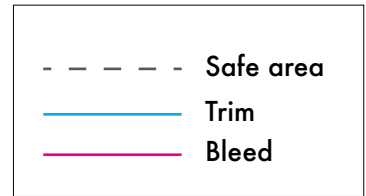

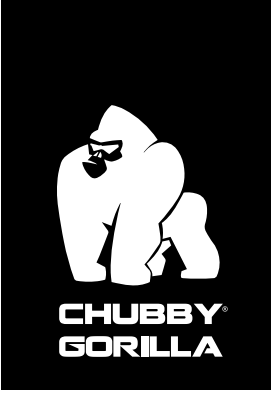

UNICORN BOTTLE® REDUCER **SKU: CGUB1-15MLR**

LABEL SIZE SUGGESTION: **inch** | 2.6" W x 1.5" H **mm** | 66 mm W x 38.57 mm H

CAPACITY: 15 mL 0.68 oz

--- Safe area
— Trim
— Bleed

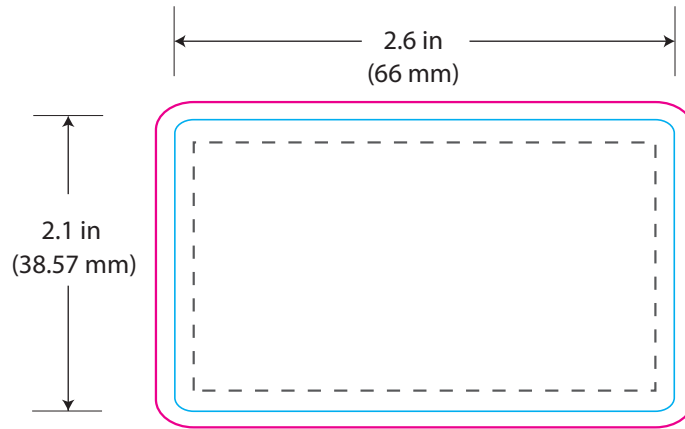

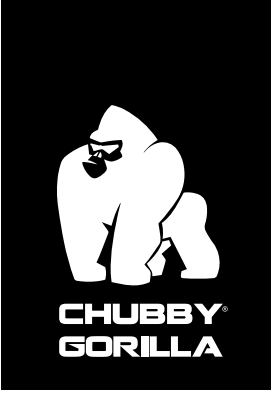

UNICORN BOTTLE® REDUCER **SKU: CGUB1-20MLR**

LABEL SIZE SUGGESTION: **inch** | 2.6" W x 2.1" H **mm** | 66 mm W x 53.34 mm H

CAPACITY: 20 mL 0.68 oz

--- Safe area
— Trim
— Bleed

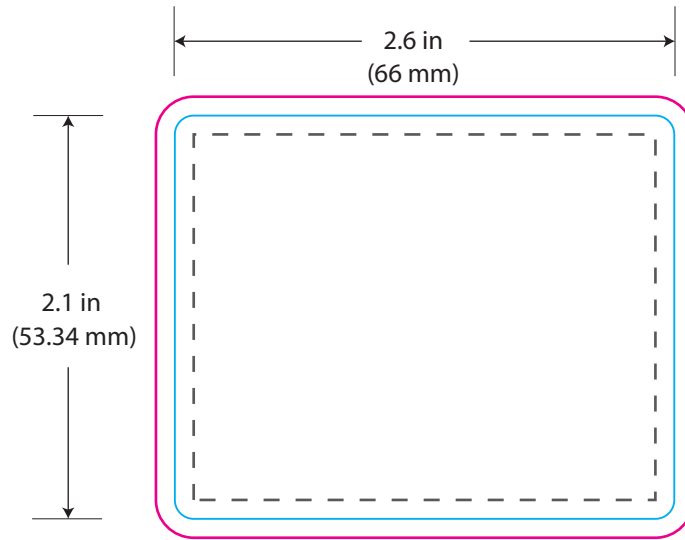

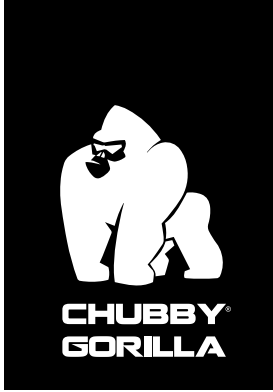

UNICORN BOTTLE® REDUCER **SKU: CGUB1-30MLR**

LABEL SIZE SUGGESTION: **inch** | 2.6" W x 3.25" H **mm** | 66.04 mm W x 82.55 mm H

CAPACITY: 30 mL 1.01 oz.

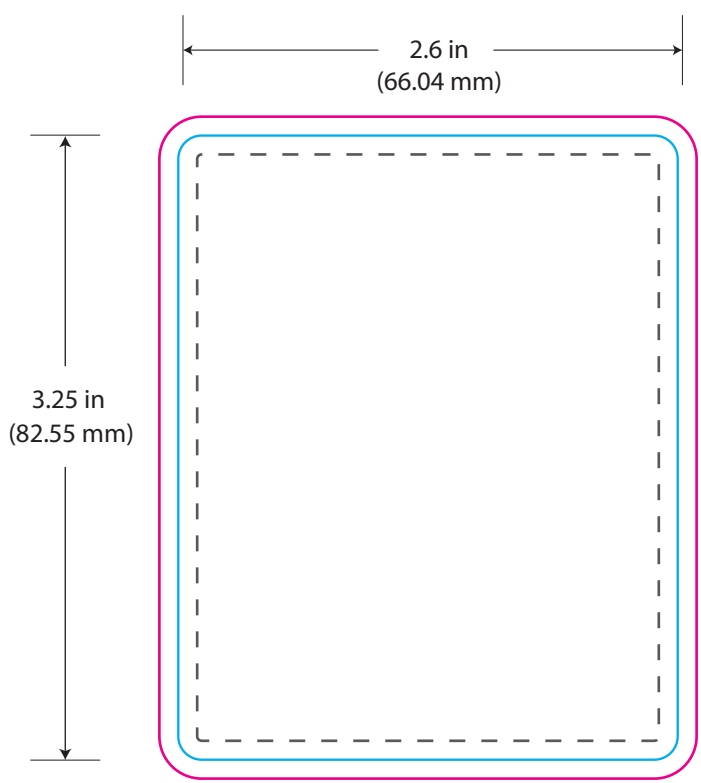
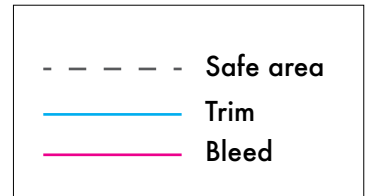

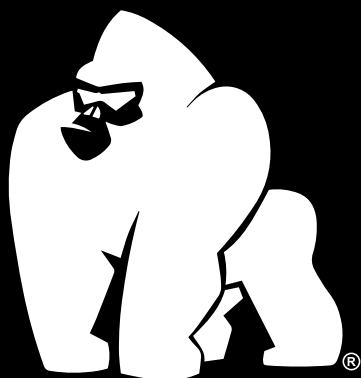

A SPECIALTY PACKAGING COMPANY

CHUBBY GORILLA® IS A SPECIALTY PACKAGING MANUFACTURER,
ENGINEERING SOLUTIONS FOR EMERGING INDUSTRIES ACROSS THE GLOBE.

GLOBAL HEADQUARTERS
CHUBBY GORILLA INC.,
4320 NORTH HARBOR BLVD,
FULLERTON, CA. 92835, USA
+1 (844) 365 - 5218 | +1 (714) 253 - 3512

CHUBBY GORILLA EUROPE BV
SMITSPOL 4A
NIJKERK, 3861 RS
NETHERLANDS
WWW.CHUBBYGORILLA.COM

DESIGNED IN ORANGE COUNTY, CALIFORNIA, U.S.A | © 2022 CHUBBY GORILLA INC. - ALL RIGHTS RESERVED

CHUBBY GORILLA, THE FIGURATIVE GORILLA LOGO AND OTHER MARKS ARE REGISTERED, PENDING OR UNREGISTERED TRADEMARKS AND/OR COPYRIGHTS OF CHUBBY GORILLA, INC. IN THE U.S. AND/OR OTHER COUNTRIES. THESE PRODUCTS MAY BE COVERED BY ONE OR MORE PATENTS OR PATENT APPLICATIONS, SEE WWW.CHUBBYGORILLA.COM/PATENTS

PRODUCT USE: MANY FACTORS BEYOND CHUBBY GORILLA'S ("CG") CONTROL AND UNIQUELY WITHIN USER'S KNOWLEDGE AND CONTROL CAN AFFECT THE USE AND PERFORMANCE OF A CG PRODUCT IN A PARTICULAR APPLICATION. GIVEN THE VARIETY OF FACTORS THAT CAN AFFECT THE USE AND PERFORMANCE OF A CG PRODUCT, USER IS SOLELY RESPONSIBLE FOR EVALUATING THE CG PRODUCT AND DETERMINING WHETHER IT IS FIT FOR A PARTICULAR PURPOSE AND SUITABLE FOR USER'S METHOD OF APPLICATION, INCLUDING BUT NOT LIMITED TO, DETERMINING WHETHER THE PRODUCT(S) PLACED WITHIN ITS PACKAGING SOLUTIONS ARE COMPATIBLE WITH EACH PARTICULAR PACKAGING SOLUTION.

WARRANTY, LIMITED REMEDY, AND DISCLAIMER: UNLESS AN ADDITIONAL WARRANTY IS SPECIFICALLY STATED ON THE APPLICABLE CG PRODUCT PACKAGING OR PRODUCT LITERATURE, CG WARRANTS THAT EACH CG PRODUCT MEETS THE APPLICABLE CG PRODUCT SPECIFICATION AT THE TIME CG SHIPS THE PRODUCT. CHUBBY GORILLA MAKES NO OTHER WARRANTIES OR CONDITIONS, EXPRESS OR IMPLIED, INCLUDING, BUT NOT LIMITED TO, ANY IMPLIED WARRANTY OR CONDITION OF MERCHANTABILITY OR FITNESS FOR A PARTICULAR PURPOSE OR ANY IMPLIED WARRANTY OR CONDITION ARISING OUT OF A COURSE OF DEALING, CUSTOM OR USAGE OF TRADE. IF THE CG PRODUCT DOES NOT CONFORM TO THIS WARRANTY, THEN THE SOLE AND EXCLUSIVE REMEDY IS, AT CG'S OPTION, REPLACEMENT OF THE CG PRODUCT OR REFUND OF THE PURCHASE PRICE.

LIMITATION OF LIABILITY: EXCEPT WHERE PROHIBITED BY LAW, CG WILL NOT BE LIABLE FOR ANY LOSS OR DAMAGE ARISING FROM THE CG PRODUCT, WHETHER DIRECT, INDIRECT, SPECIAL, INCIDENTAL OR CONSEQUENTIAL, REGARDLESS OF THE LEGAL THEORY ASSERTED, INCLUDING WARRANTY, CONTRACT, NEGLIGENCE OR STRICT LIABILITY.