

## AVIATOR®

CONTAINERS, XL CONTAINERS, BOTTLES,  
TUBES, CARTRIDGE CONTAINERS and BASE BOTTLES

**DIMENSION &  
LABEL SUGGESTION GUIDE**

# AVIATOR® CONTAINERS

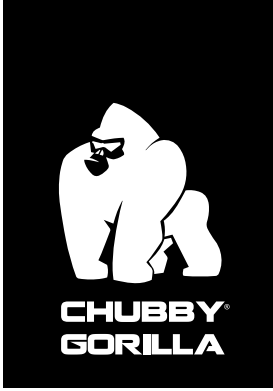

**AVIATOR® CONTAINER**

**SKU: CGAC1-1OZ**

**LABEL SIZE SUGGESTION:**

**inch** | 6.1" W x 0.47" H

**mm** | 155 mm W x 12 mm H

**CAPACITY:**

1 oz.

30 mL

30 cc

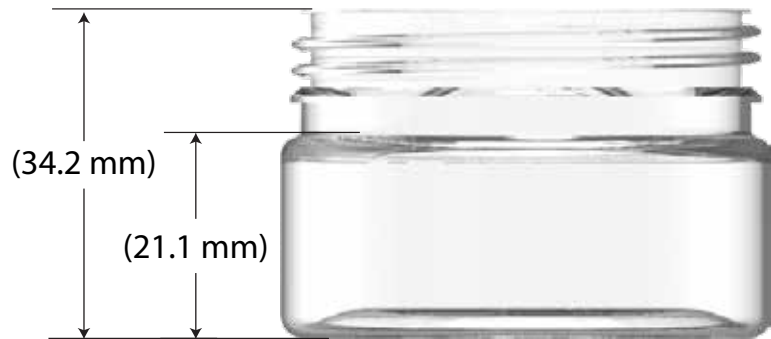
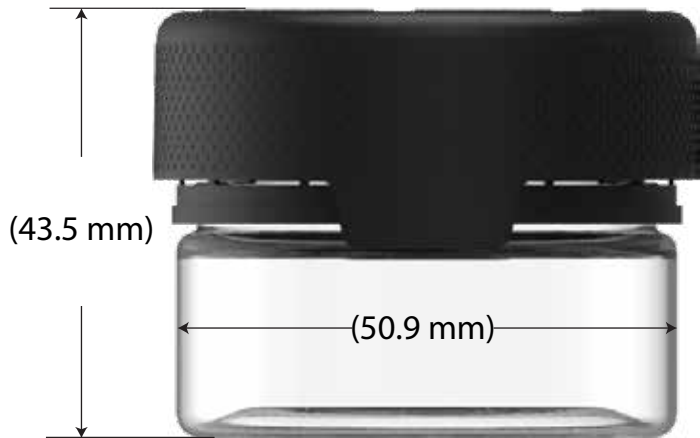

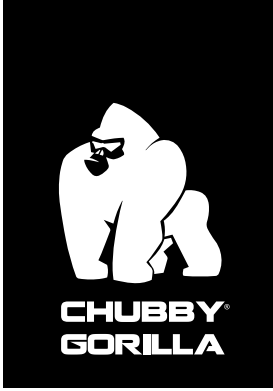

**AVIATOR® CONTAINER**

**SKU: CGAC1-1OZ**

**LABEL SIZE SUGGESTION:**

**inch** | 6.1" W x 0.47" H

**mm** | 155 mm W x 12 mm H

**CAPACITY:**

1 oz.

30 mL

30 cc

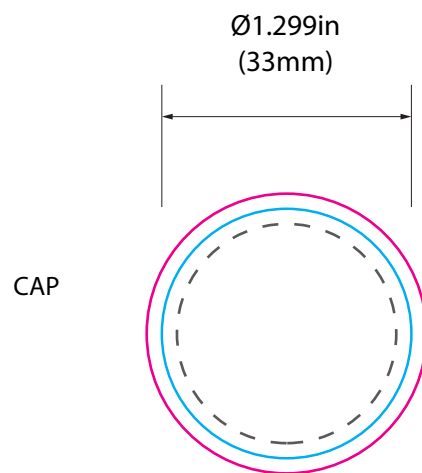
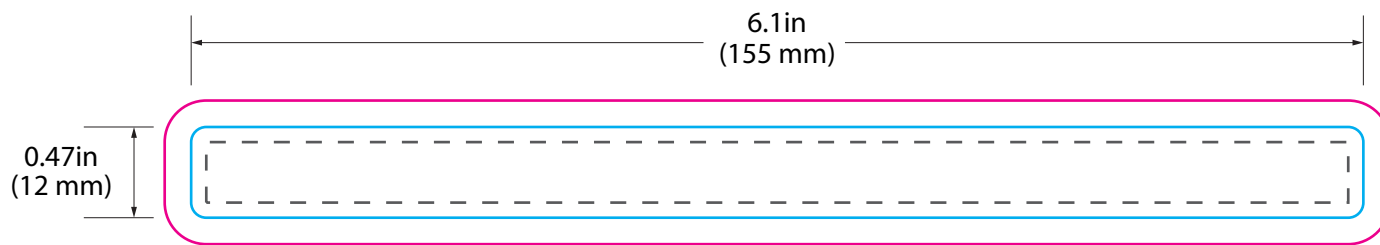
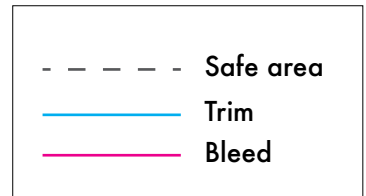

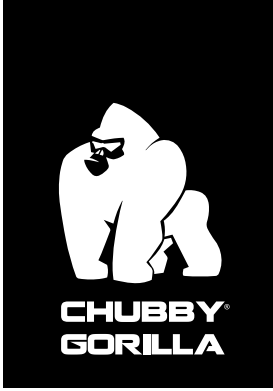

**AVIATOR® CONTAINER**

**SKU: CGAC1-2OZ**

<b>LABEL SIZE SUGGESTION:</b>	<b>inch</b>	6.1" W x 1.22" H	<b>mm</b>	155 mm W x 31 mm H
	<b>CAPACITY:</b>			
	2 oz.	60 mL	60 cc	

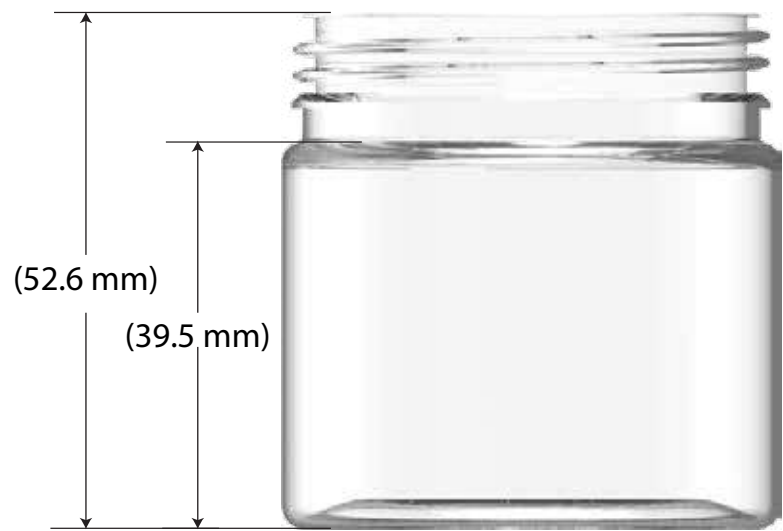
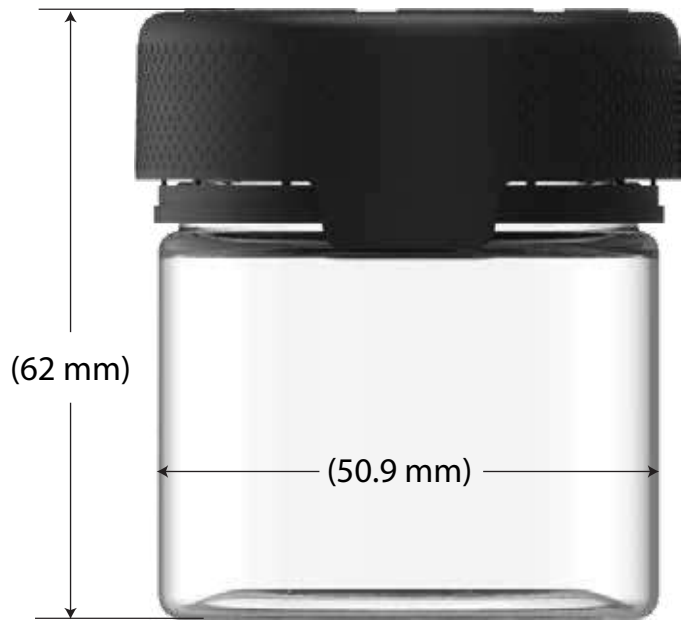
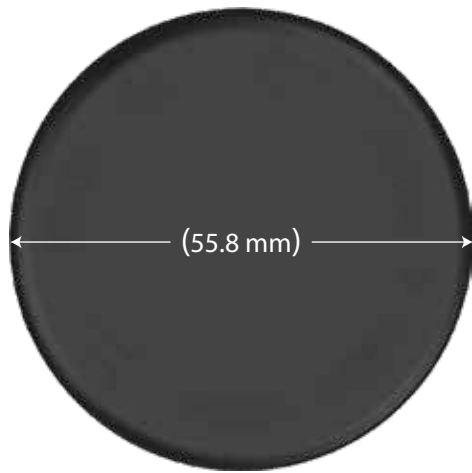

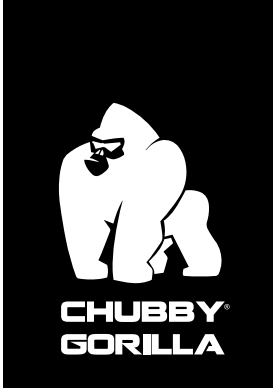

**AVIATOR® CONTAINER**

**SKU: CGAC1-2OZ**

**LABEL SIZE SUGGESTION:**    **inch** | 6.1" W x 1.22" H    **mm** | 155 mm W x 31 mm H

**CAPACITY:**                      2 oz.                      60 mL                      60 cc

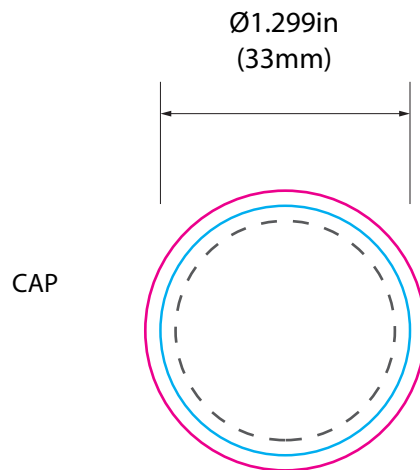
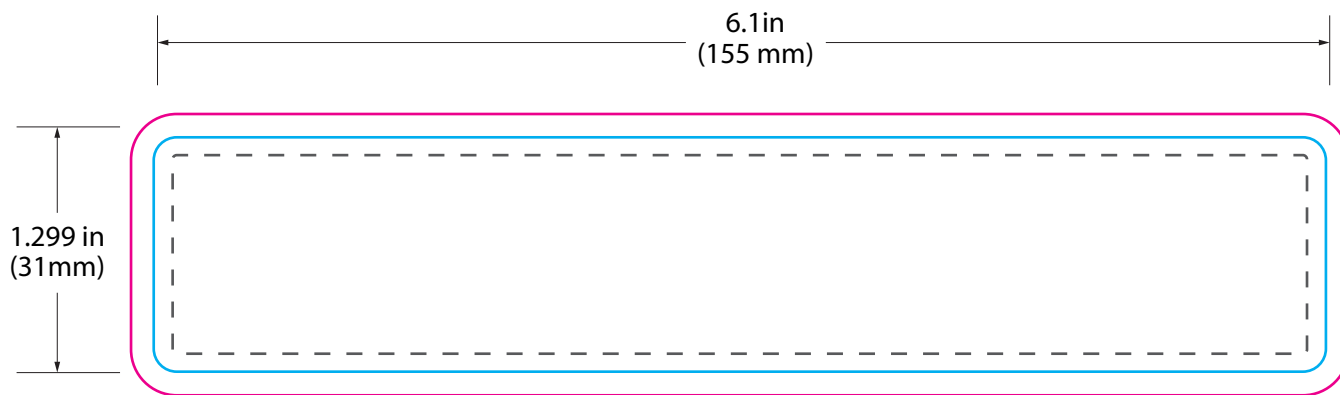
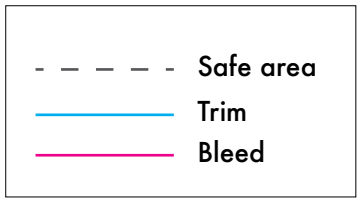

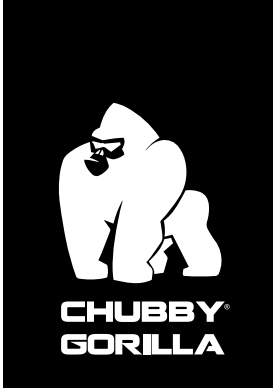

**AVIATOR® CONTAINER**

**SKU: CGAC1-3OZ**

**LABEL SIZE SUGGESTION:**

<b>inch</b>	6.1" W x 1.456" H	<b>mm</b>	155 mm W x 37 mm H
-------------	-------------------	-----------	--------------------

**CAPACITY:**

3 oz.	90 mL	90 cc
-------	-------	-------

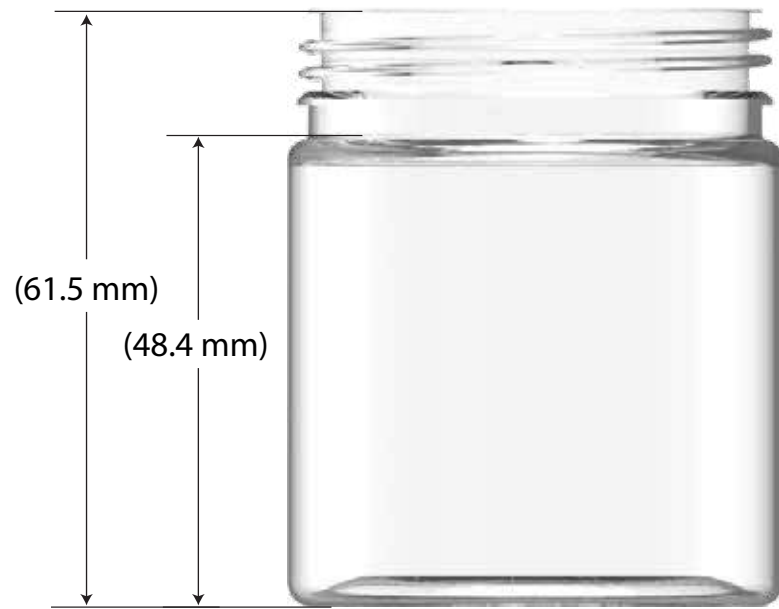
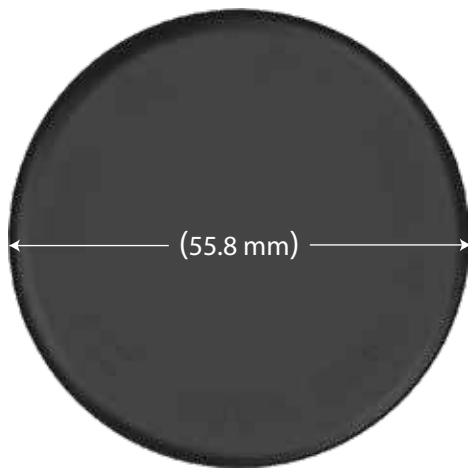

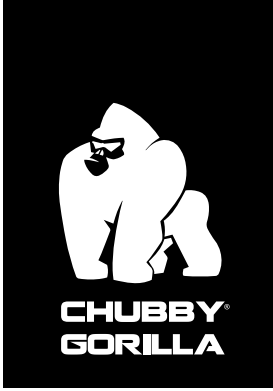

**AVIATOR® CONTAINER**

**SKU: CGAC1-3OZ**

**LABEL SIZE SUGGESTION:**

**inch** | 6.1" W x 1.456" H

**mm** | 155 mm W x 37 mm H

**CAPACITY:**

3 oz.

90 mL

90 cc

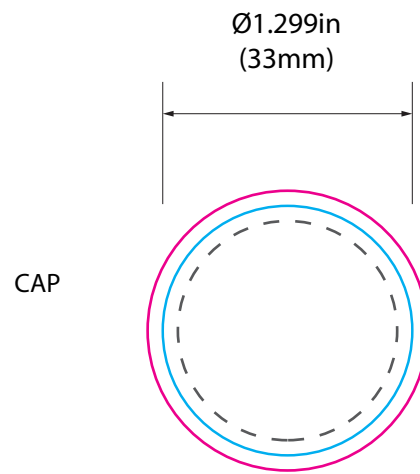
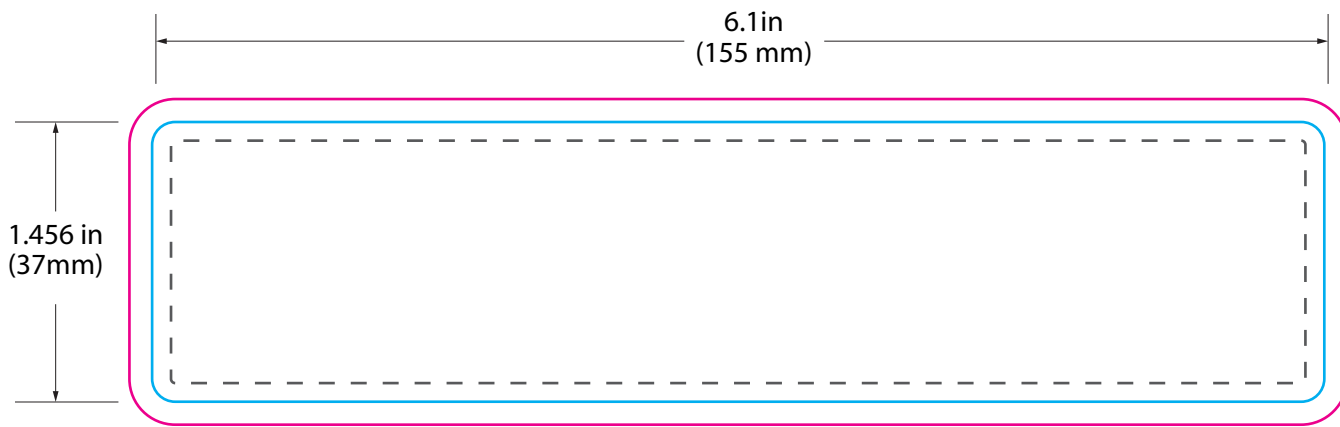
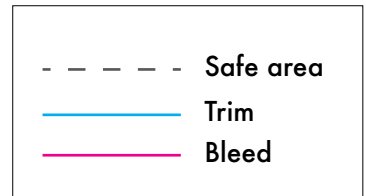



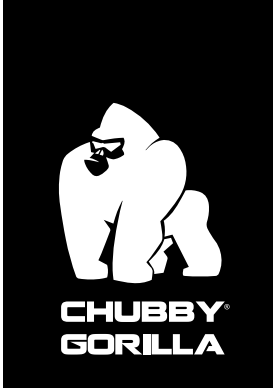

**AVIATOR® CONTAINER**

**SKU: CGAC1-4OZ**

**LABEL SIZE SUGGESTION:**

**inch** | 6.1" W x 2" H

**mm** | 155 mm W x 51 mm H

**CAPACITY:**

4 oz.

120 mL

120 cc

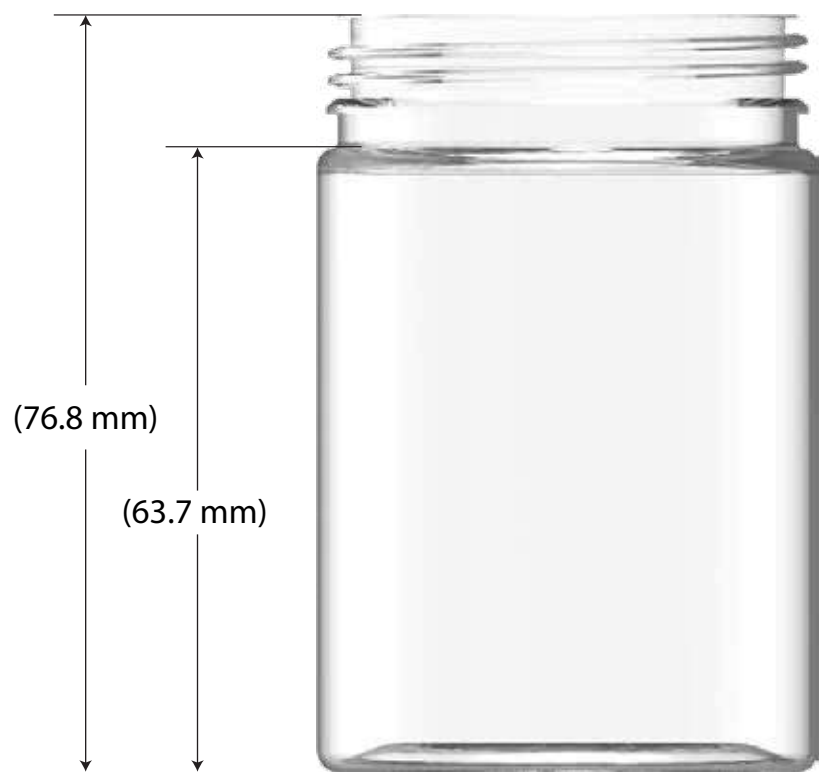
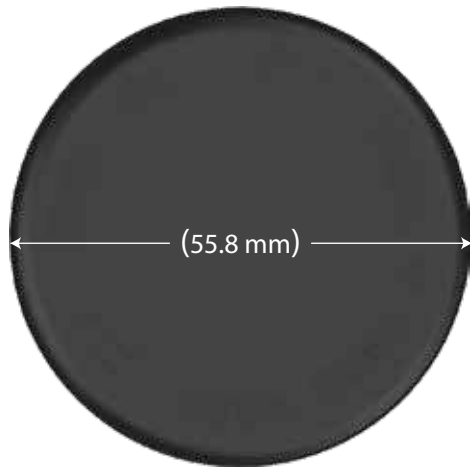

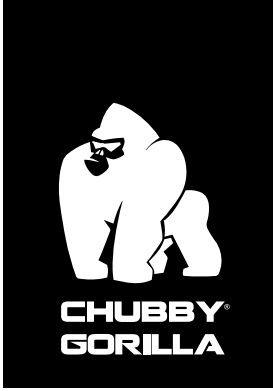

**AVIATOR® CONTAINER**

**SKU: CGAC1-4OZ**

**LABEL SIZE SUGGESTION:**

**inch** | 6.1" W x 2" H

**mm** | 155 mm W x 51 mm H

**CAPACITY:**

4 oz.

120 mL

120 cc

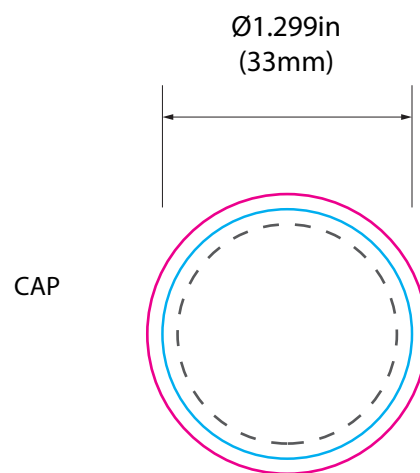
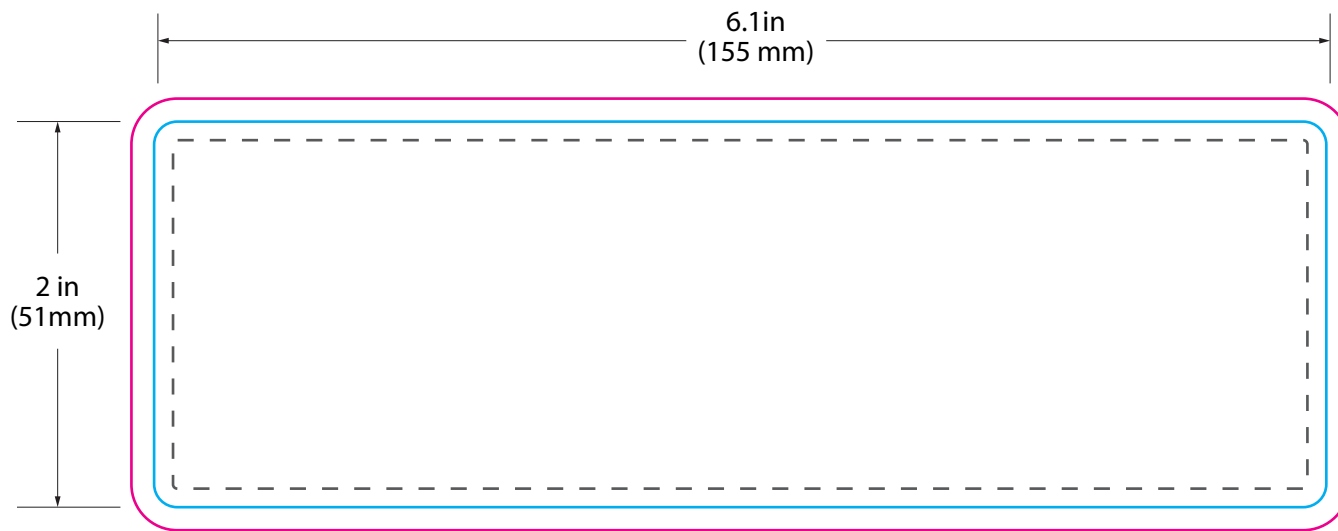
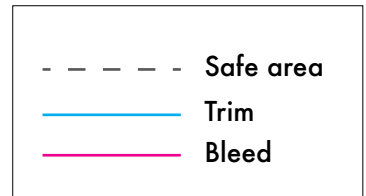

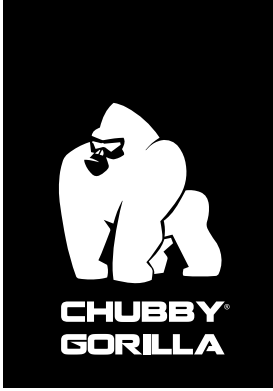

**AVIATOR® CONTAINER**

**SKU: CGAC1-5OZ**

**LABEL SIZE SUGGESTION:**

**inch** | 6.1" W x 2.59" H

**mm** | 155 mm W x 66 mm H

**CAPACITY:**

5 oz.

150 mL

150 cc

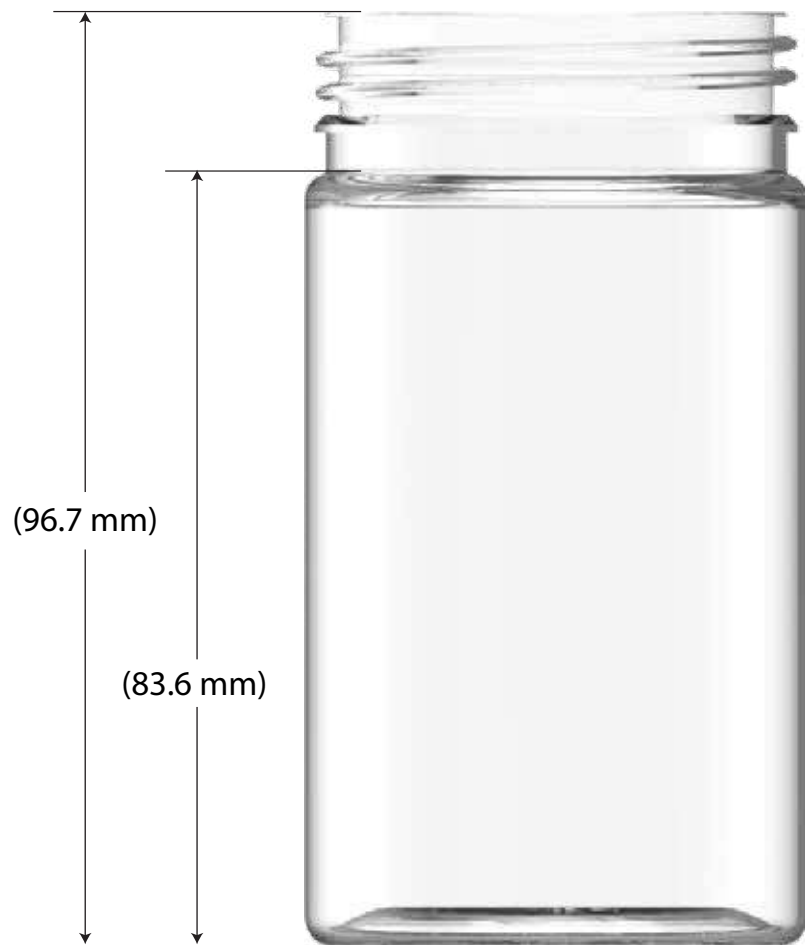
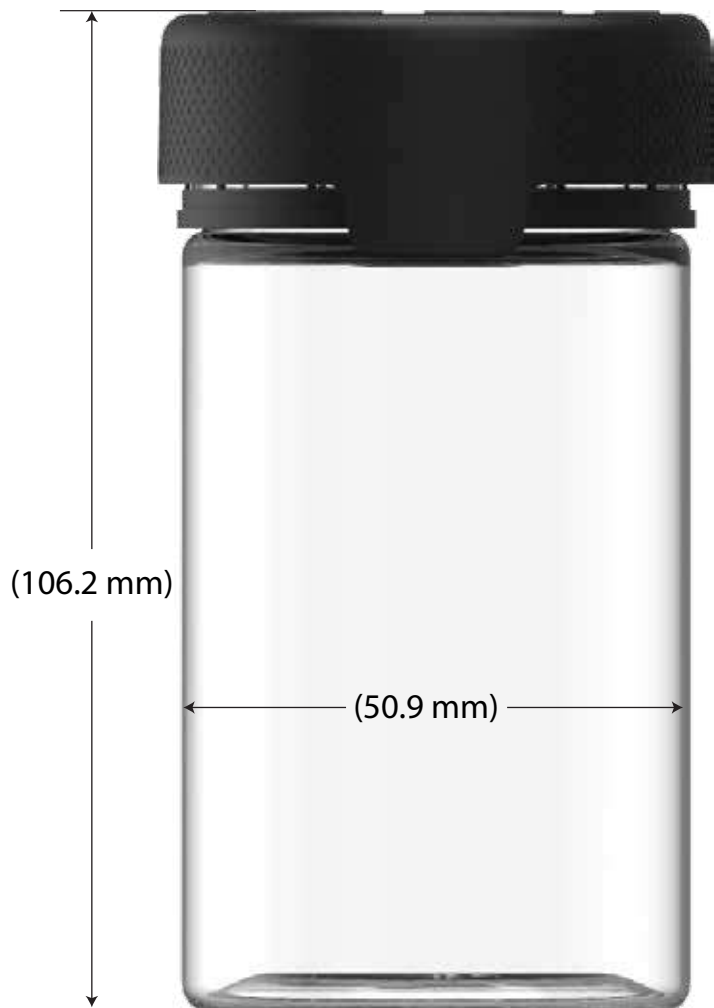
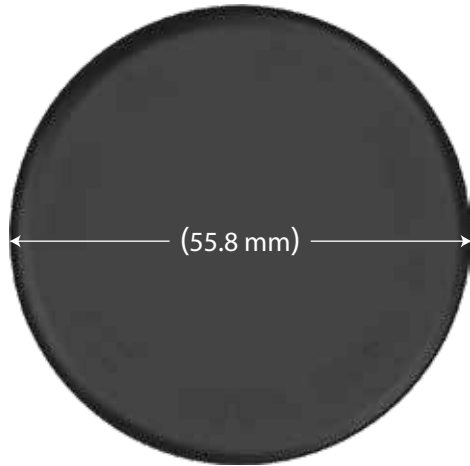

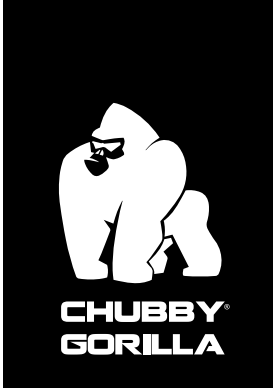

**AVIATOR® CONTAINER**

**SKU: CGAC1-5OZ**

**LABEL SIZE SUGGESTION:**

**inch** | 6.1" W x 2.59" H

**mm** | 155 mm W x 66 mm H

**CAPACITY:**

5 oz.

150 mL

150 cc

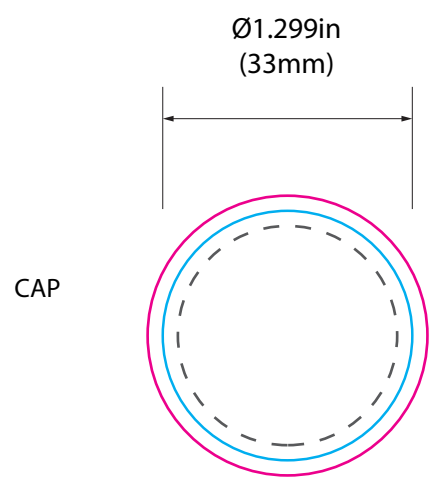
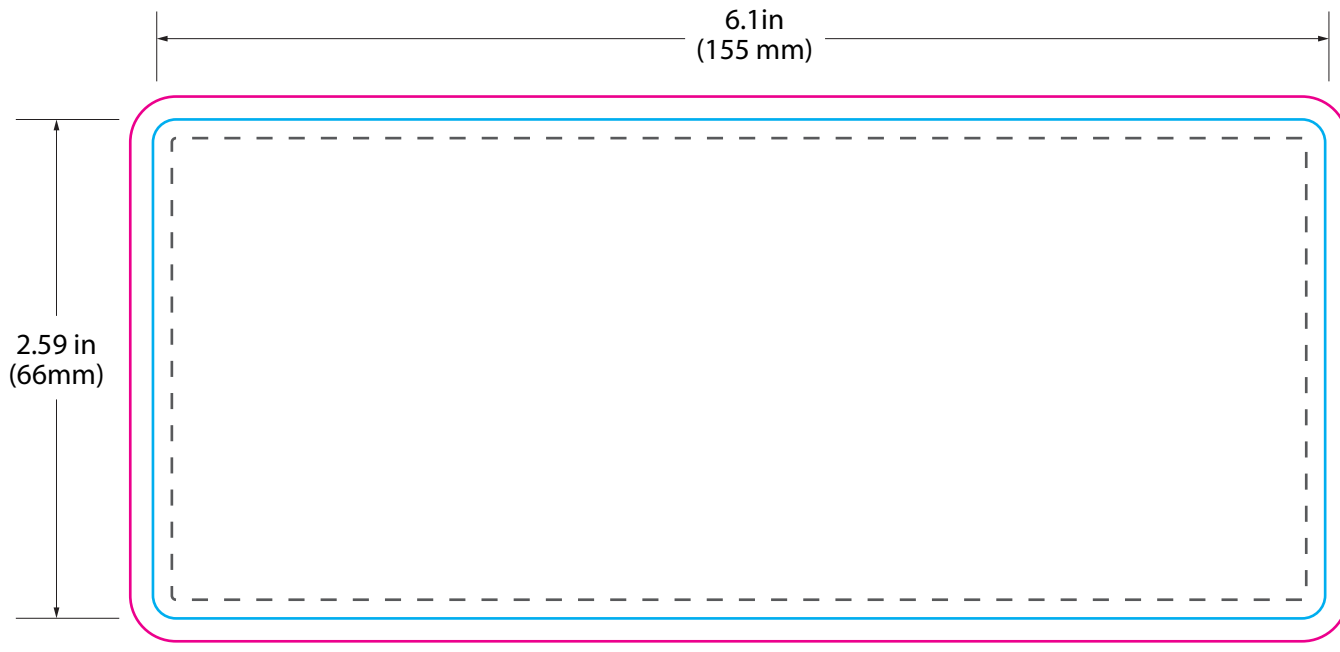
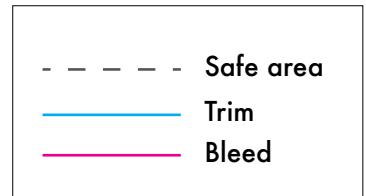

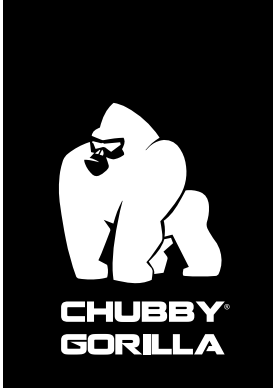

**AVIATOR® CONTAINER**

**SKU: CGAC1-6OZ**

**LABEL SIZE SUGGESTION:**

**inch** | 6.1" W x 3.385" H

**mm** | 155 mm W x 86 mm H

**CAPACITY:**

6 oz.

180 mL

180 cc

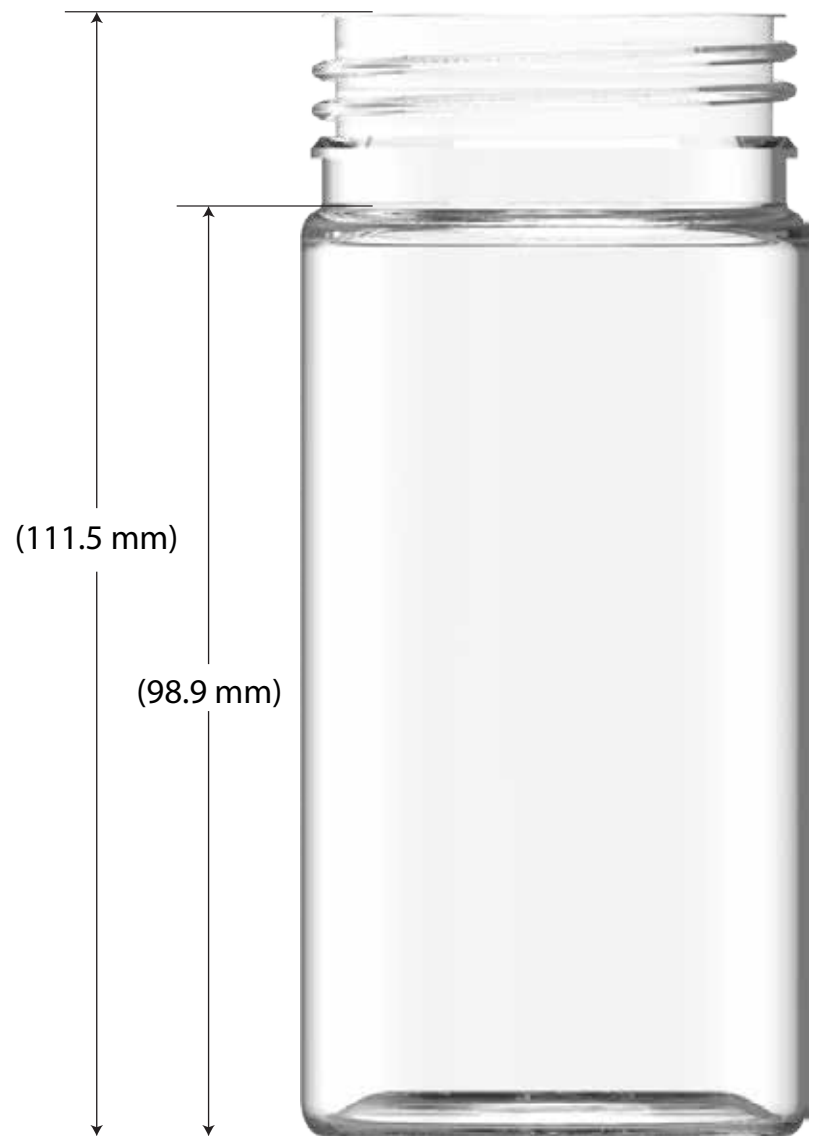
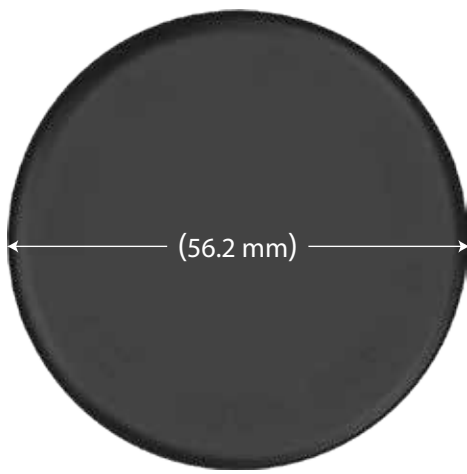

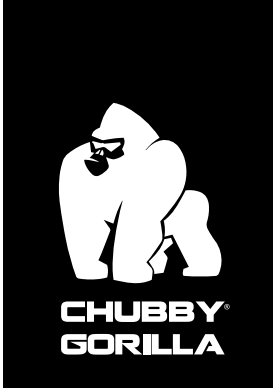

**AVIATOR® CONTAINER**

**SKU: CGAC1-6OZ**

**LABEL SIZE SUGGESTION:**    **inch** | 6.1" W x 3.385" H    **mm** | 155 mm W x 86 mm H

**CAPACITY:**                      6 oz.                                      180 mL                                      180 cc

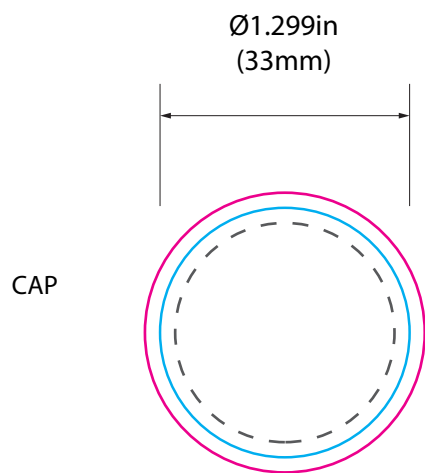
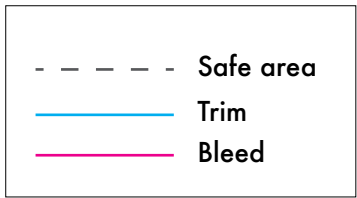

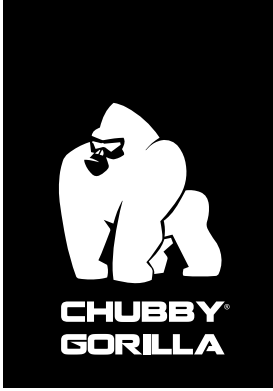

**AVIATOR® CONTAINER**

**SKU: CGAC1-8OZ**

**LABEL SIZE SUGGESTION:**

**inch** | 6.18" W x 4.33" H

**mm** | 157 mm W x 110 mm H

**CAPACITY:**

8 oz.

240 mL

240 cc

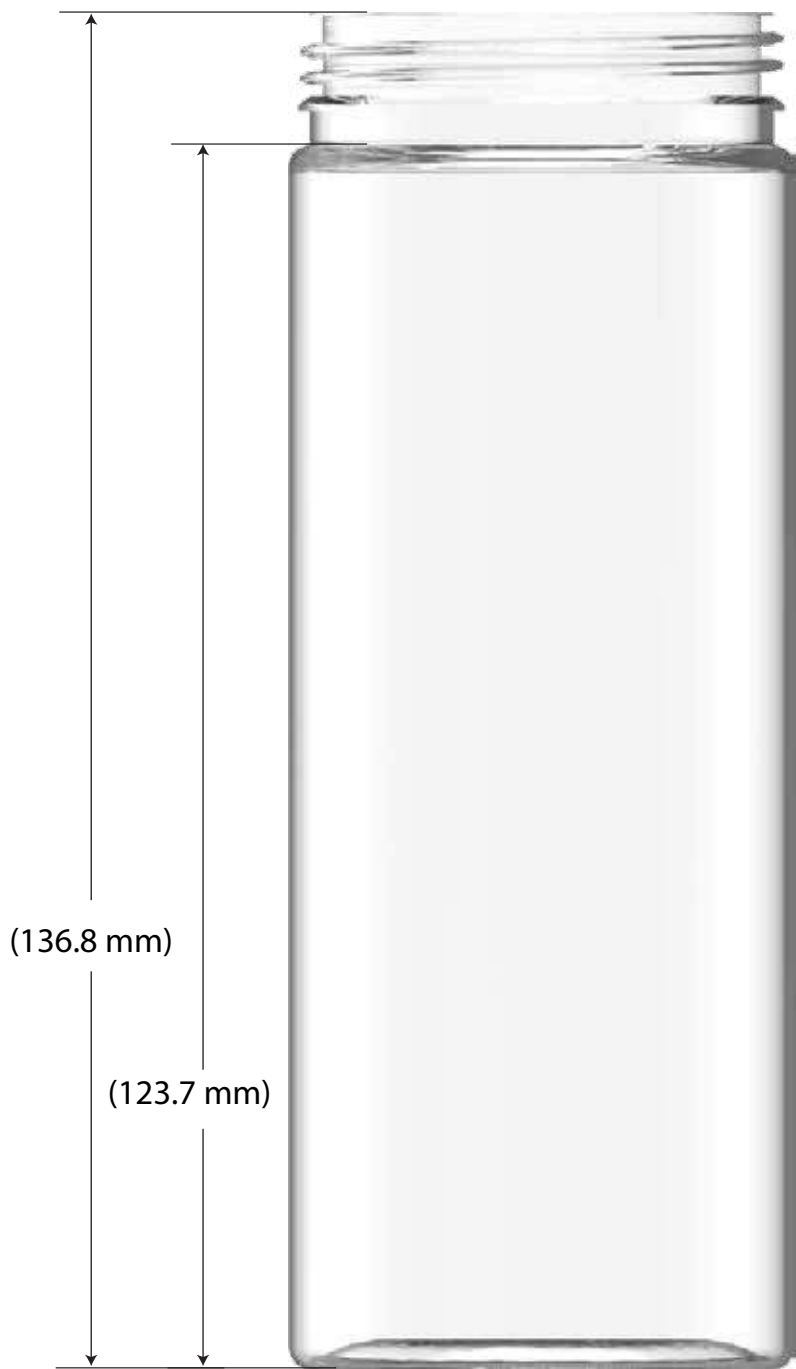
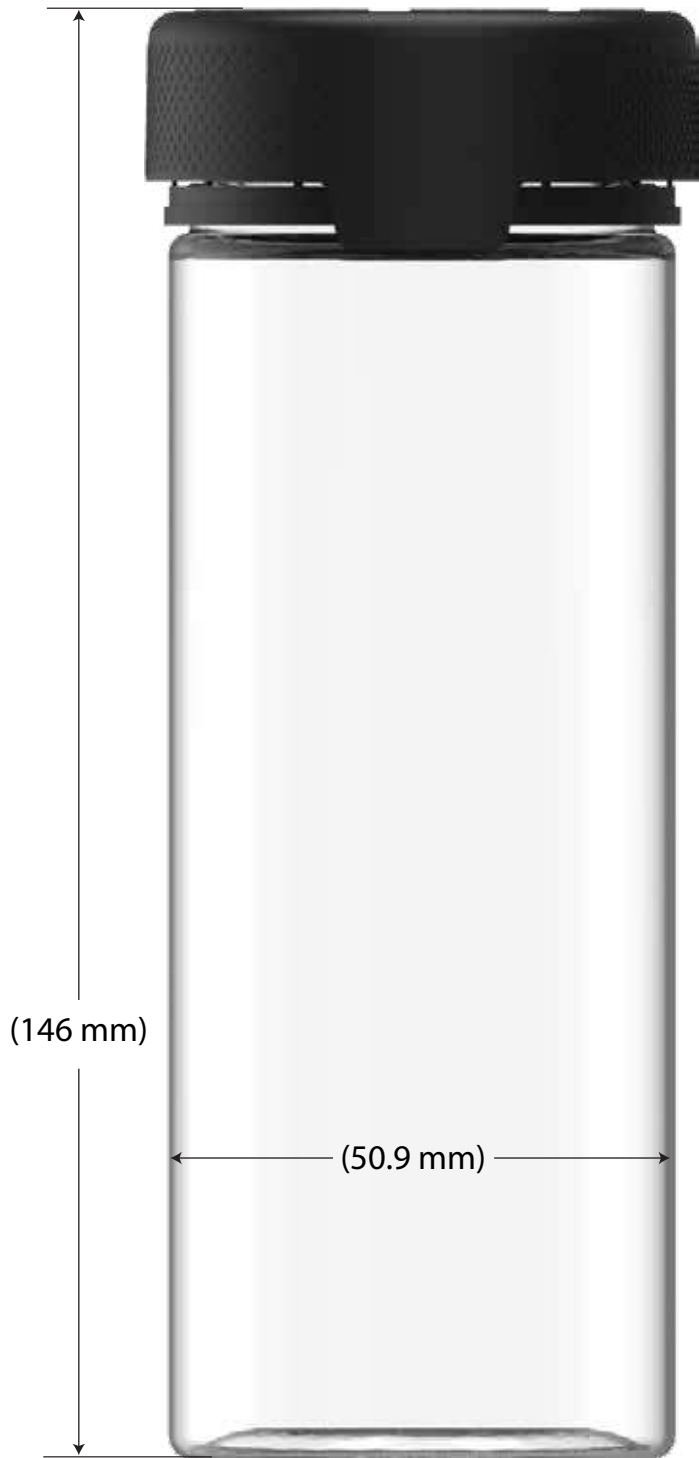
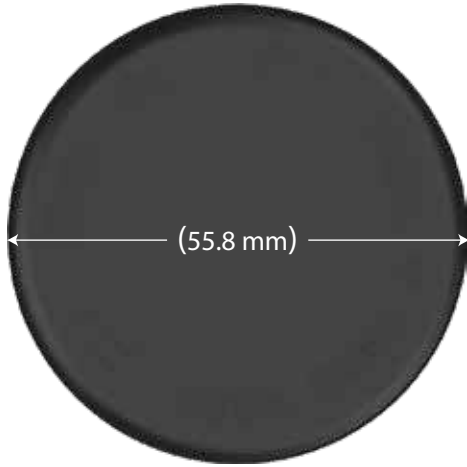

**AVIATOR® CONTAINER**

**CGAC1-8OZ**

**Label guide** →

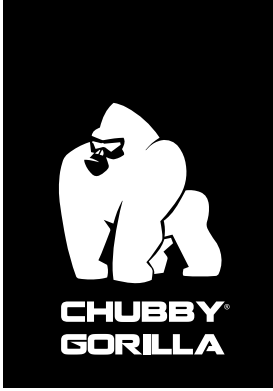

**AVIATOR® CONTAINER**

**SKU: CGAC1-8OZ**

**LABEL SIZE SUGGESTION:**

**inch** | 6.18" W x 4.33" H

**mm** | 157 mm W x 110 mm H

**CAPACITY:**

8 oz.

240 mL

240 cc

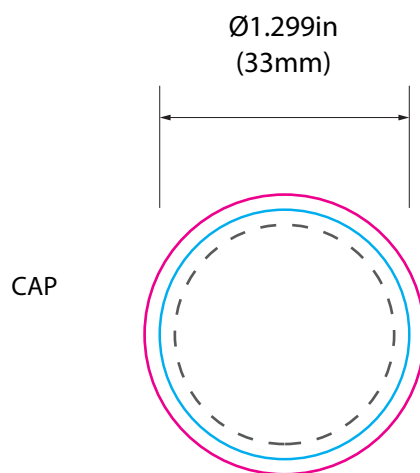
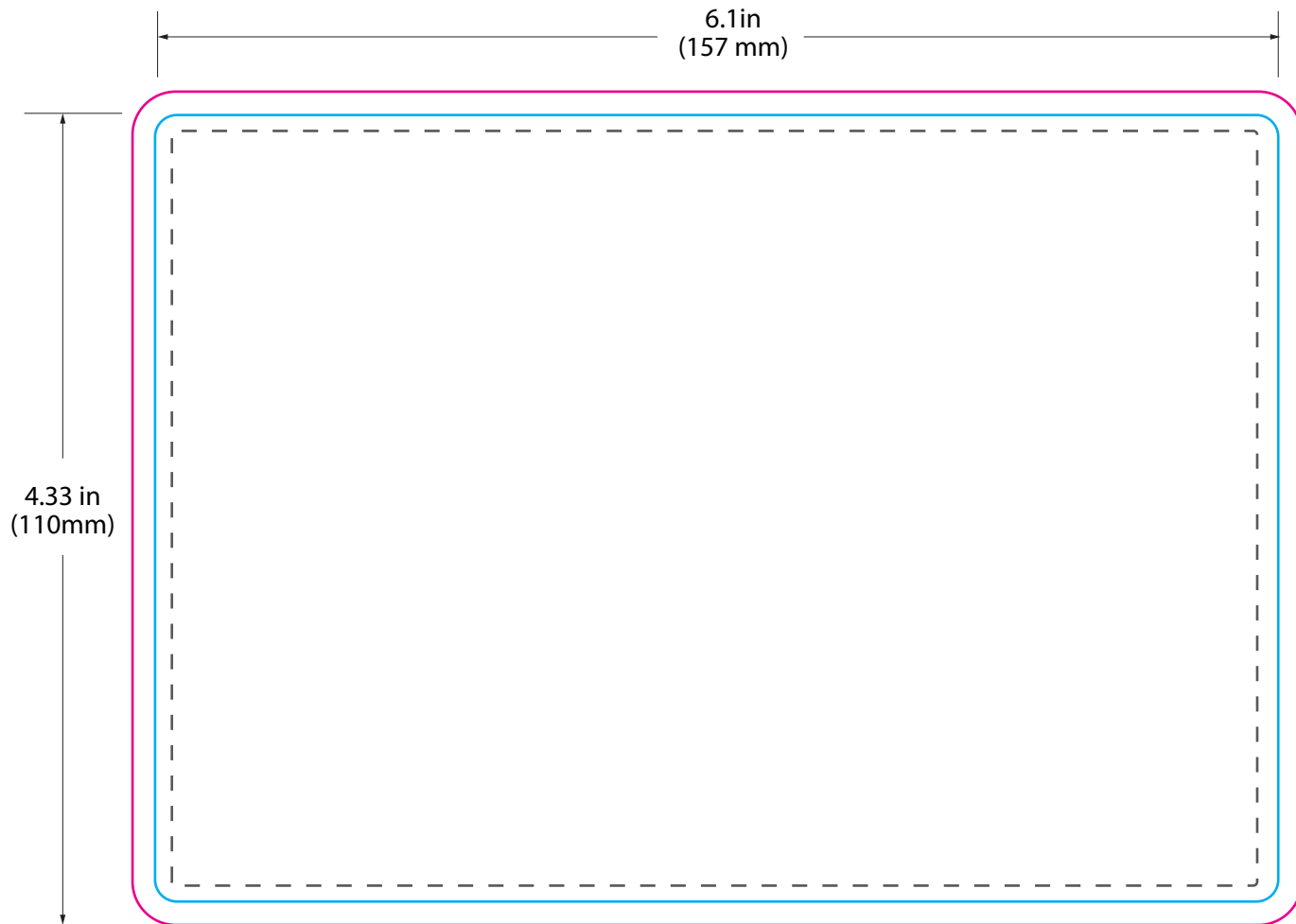
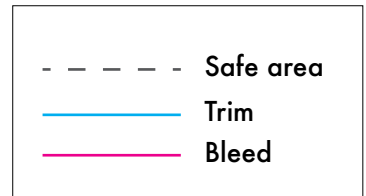



# AVIATOR® XL CONTAINERS

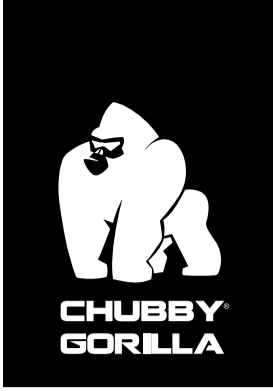

**AVIATOR® XL CONTAINER**

**SKU:** CGAC1-7.5OZXL

**LABEL SIZE SUGGESTION:**

**inch** | 10.629" W x 1.102" H

**mm** | 270 mm W x 28 mm H

**CAPACITY:**

7.5 oz.

220 mL

220 cc



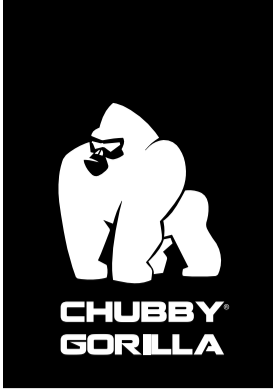

**AVIATOR® XL CONTAINER**

**SKU: CGAC1-7.5OZXL**

**LABEL SIZE SUGGESTION:**

**inch** | 11.023" W x 1.102" H

**mm** | 280 mm W x 28 mm H

**CAPACITY:**

7.5 oz.

220 mL

220 cc

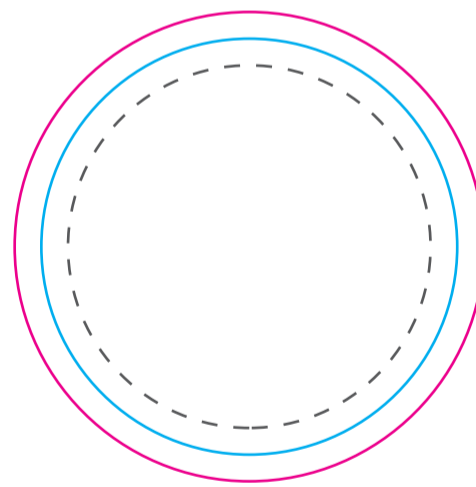
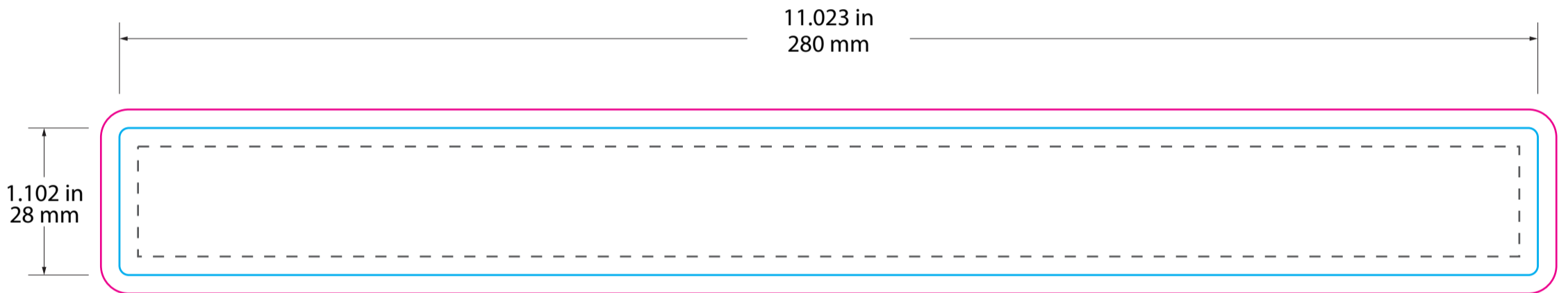
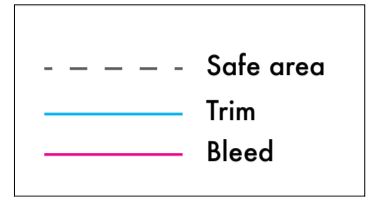

Ø2.16 in  
(55 mm)



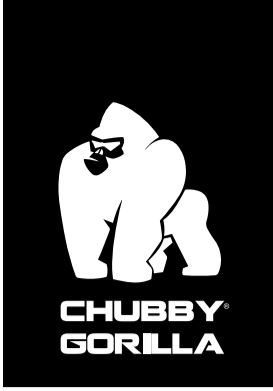

**AVIATOR® XL CONTAINER**

**SKU:** CGAC1-10OZXL

**LABEL SIZE SUGGESTION:**

**inch** | 10.629" W x 1.437" H

**mm** | 270 mm W x 36.5 mm H

**CAPACITY:**

10 oz.

300 mL

300 cc

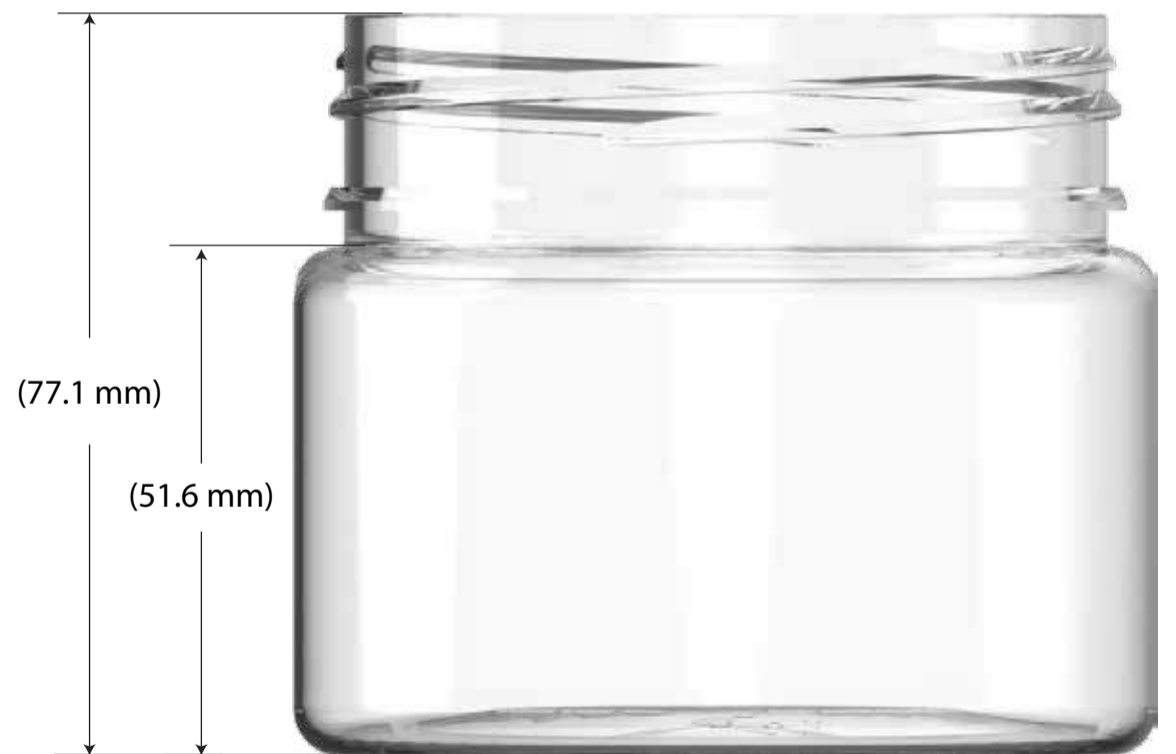
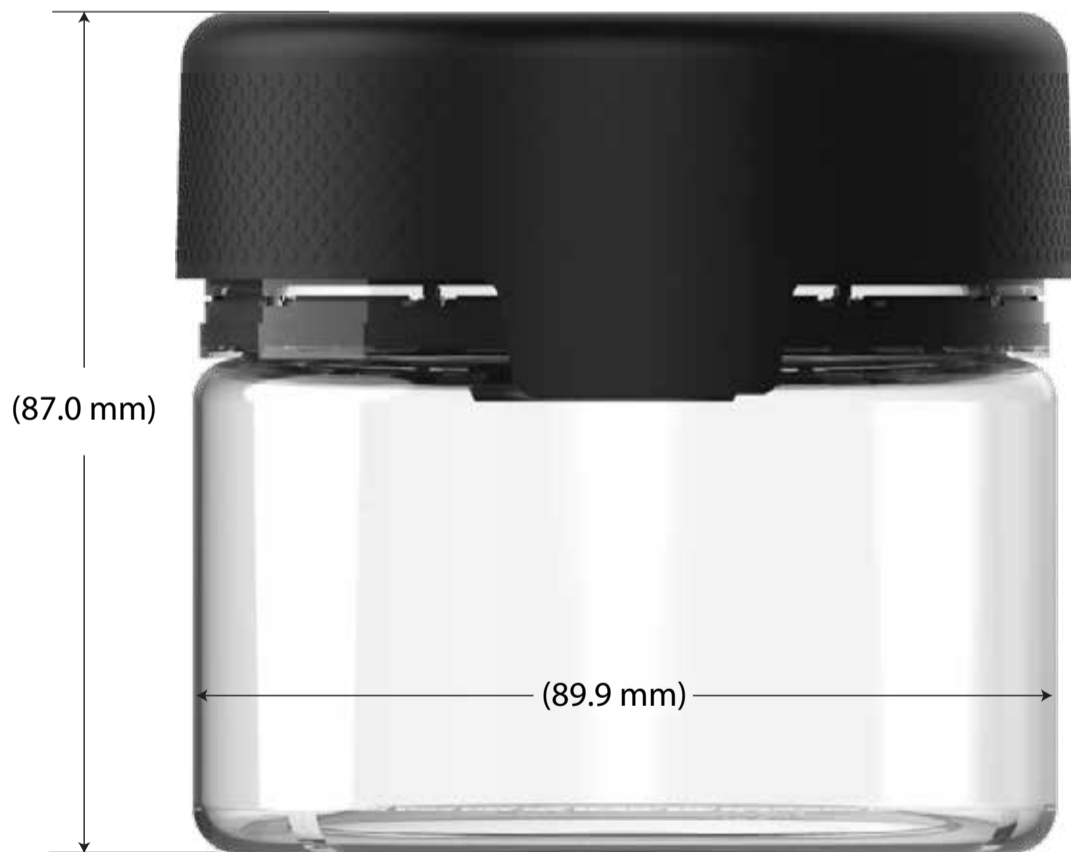

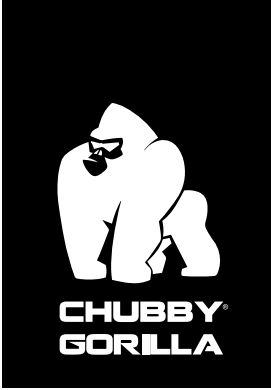

**AVIATOR® XL CONTAINER**

**SKU:** CGAC1-10OZXL

**LABEL SIZE SUGGESTION:**

**inch** | 11.023" W x 1.437" H

**mm** | 280 mm W x 36.5 mm H

**CAPACITY:**

10 oz.

220 mL

220 cc

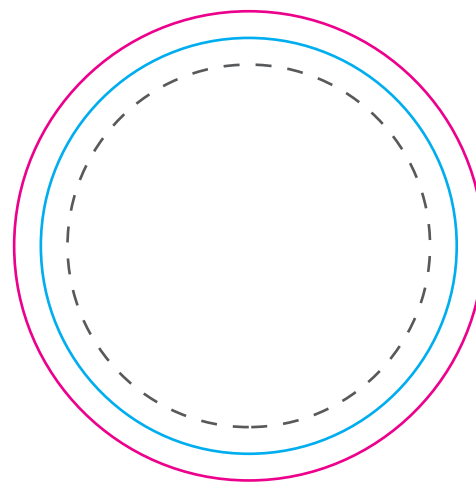
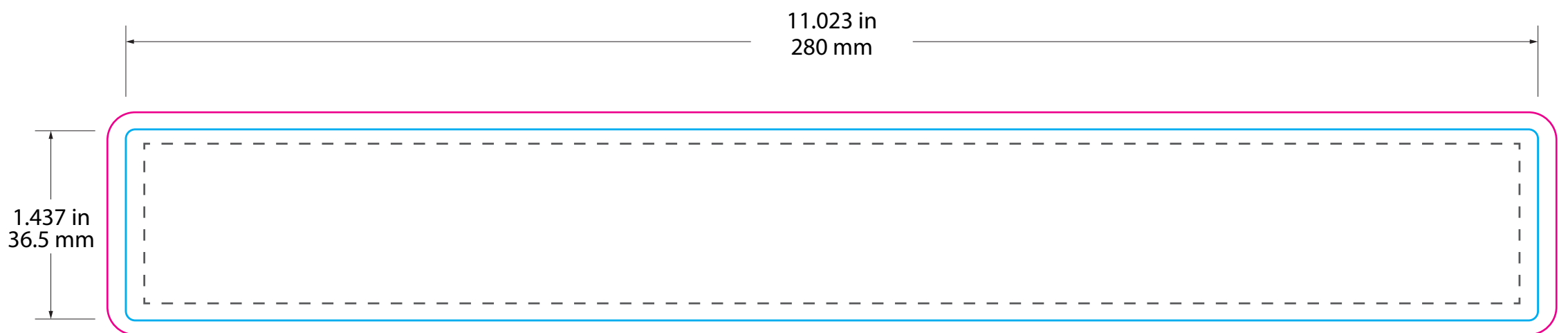
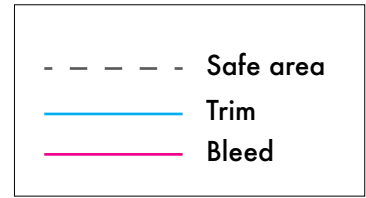

Ø2.16 in  
(55 mm)



**AVIATOR® XL CONTAINER**

CGAC1-10OZXL

10 oz.

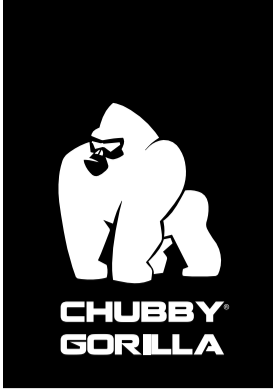

**AVIATOR® XL CONTAINER**

**SKU: CGAC1-18.5OZXL**

**LABEL SIZE SUGGESTION:**

**inch** | 11.338" W x 2.95" H

**mm** | 288 mm W x 75 mm H

**CAPACITY:**

18.5 oz.

550 mL

550 cc

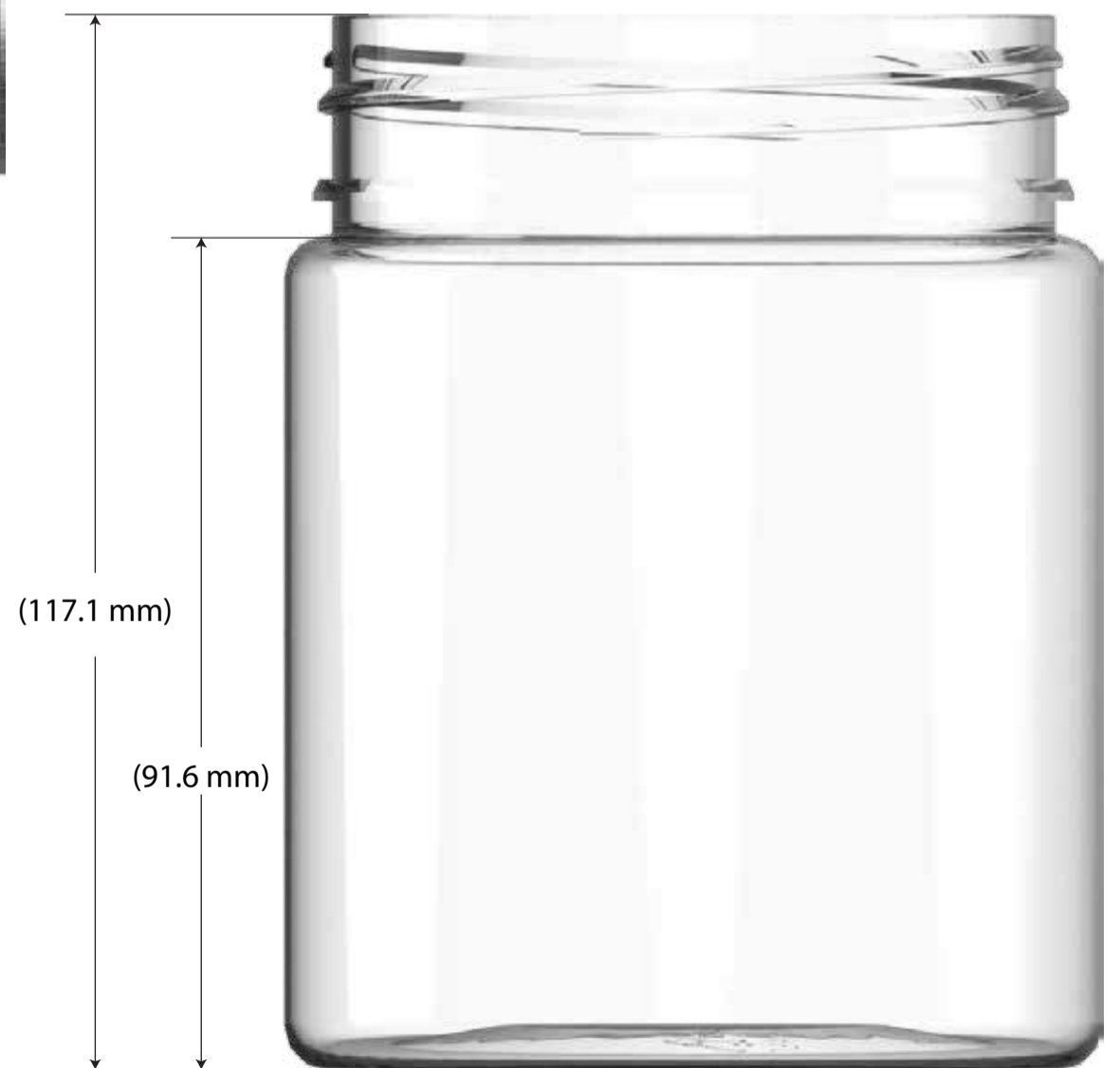

**AVIATOR® XL CONTAINER**

**CGAC1-18.5OZXL**

**Label guide** →

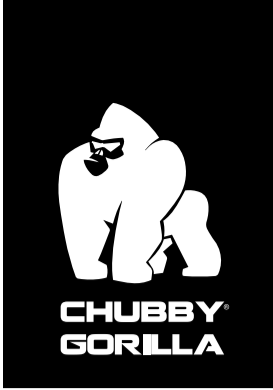

**AVIATOR® CONTAINER**

**SKU:** CGAC1-18.5OZXL

**LABEL SIZE SUGGESTION:**

**inch** | 11.023" W x 2.95" H

**mm** | 280 mm W x 75 mm H

**CAPACITY:**

18.5 oz.

550 mL

550 cc

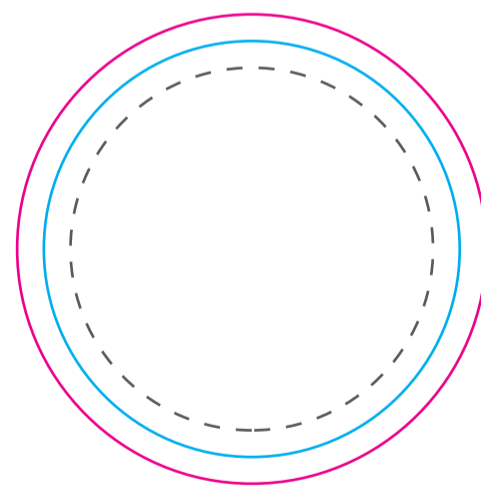
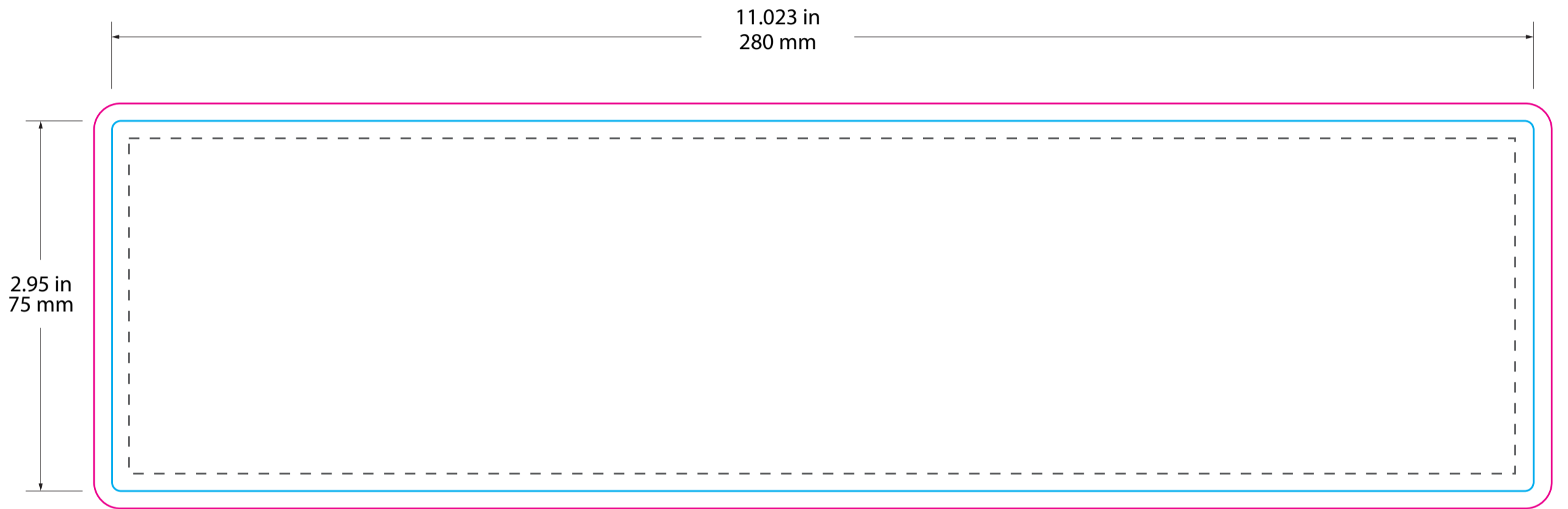
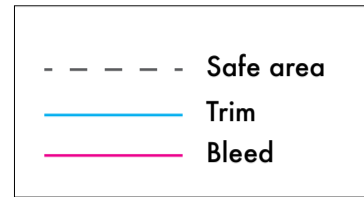

Ø2.16 in  
(55 mm)



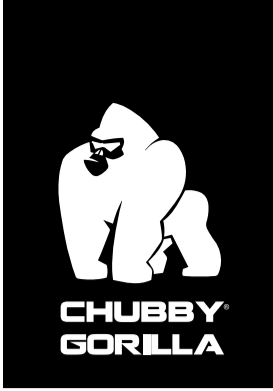

**AVIATOR® XL CONTAINER**

**SKU:** CGAC1-21.5OZXL

**LABEL SIZE SUGGESTION:**

**inch** | 11.378" W x 3.346" H

**mm** | 288 mm W x 85 mm H

**CAPACITY:**

21.5 oz.

625 mL

625 cc

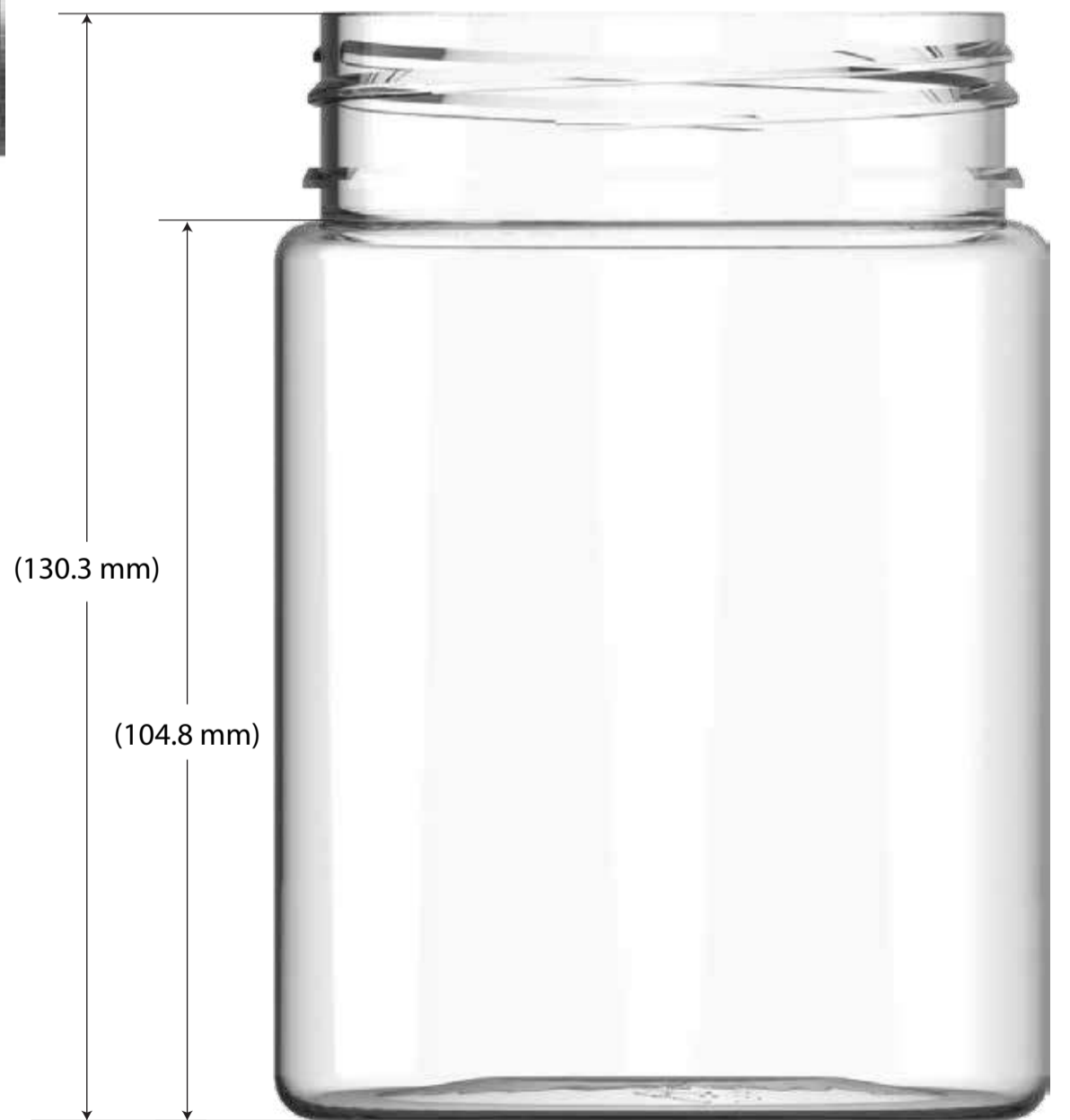

**AVIATOR® XL CONTAINER**

CGAC1-21.5OZXL

Label guide →



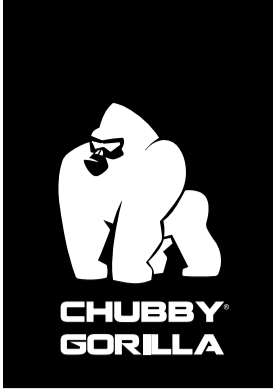

**AVIATOR® XL CONTAINER**

**SKU:** CGAC1-21.5OZXL

**LABEL SIZE SUGGESTION:**

**inch** | 11.023" W x 3.346" H

**mm** | 280 mm W x 85 mm H

**CAPACITY:**

21.5 oz.

625 mL

625 cc

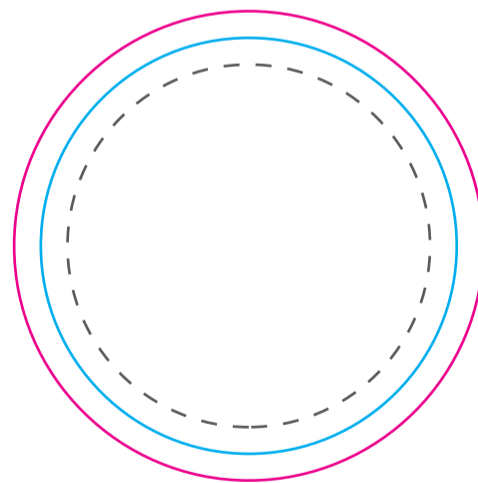
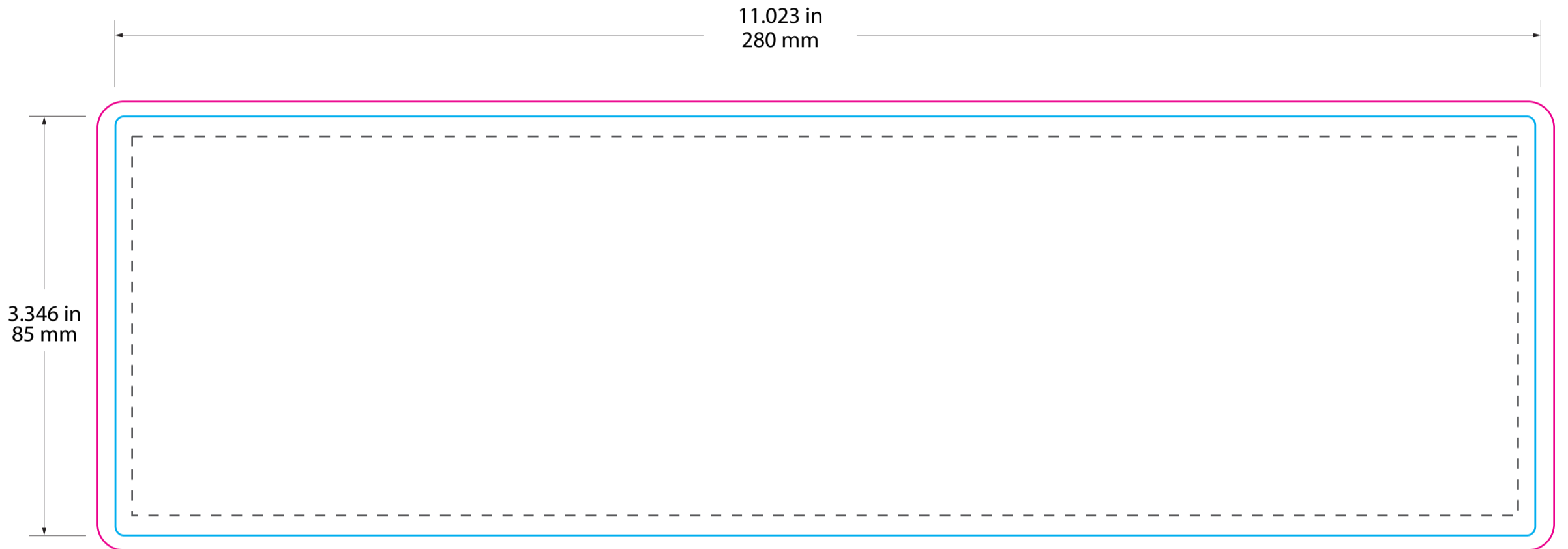
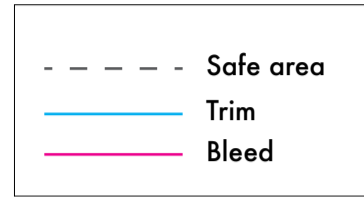

Ø2.16 in  
(55 mm)



**AVIATOR® XL CONTAINER**

CGAC1-21.5OZXL

21.5 oz.

# AVIATOR® BOTTLES

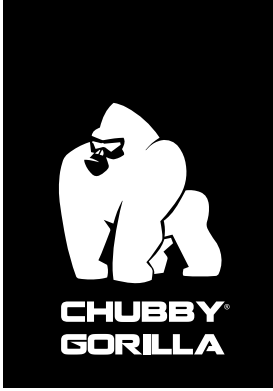

**AVIATOR® BOTTLE**

**SKU: CGAB1-10ML**

**LABEL SIZE SUGGESTION:**

**inch** | 2.6" W x 1.12" H

**mm** | 66.04 mm W x 28.47 mm H

**CAPACITY:**

10 mL

0.34 oz.

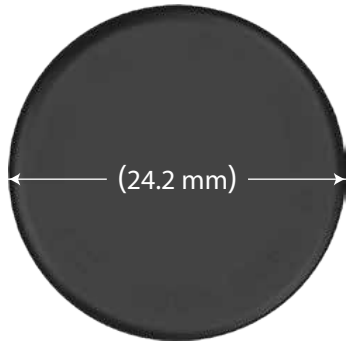



**AVIATOR® BOTTLE**

**SKU: CGAB1-10ML**

**LABEL SIZE SUGGESTION:**    **inch** | 2.6" W x 1.12" H    **mm** | 66.04 mm W x 28.57 mm H

**CAPACITY:**                      10 mL                      0.34 oz.

--- Safe area  
— Trim  
— Bleed

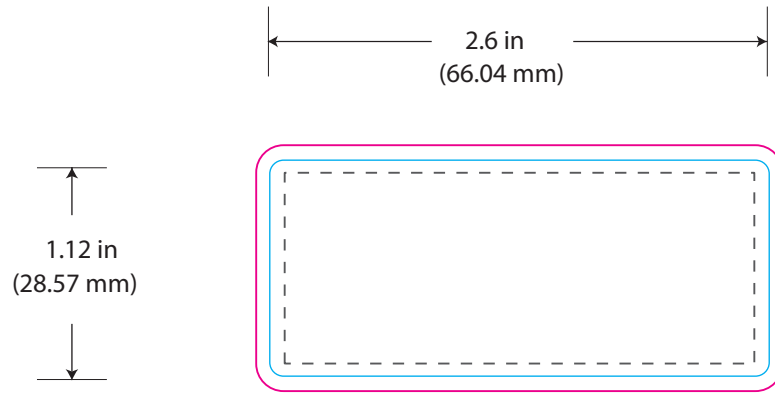

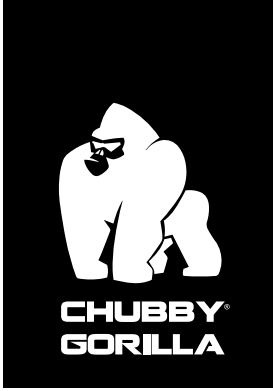

**AVIATOR® BOTTLE**

**SKU:** CGAB1-16.5ML

**LABEL SIZE SUGGESTION:**

**inch** | 2.59" W x 1.8" H

**mm** | 66 mm W x 45.72 mm H

**CAPACITY:**

16.5 mL

0.56 oz.

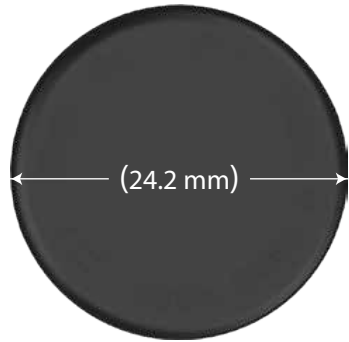

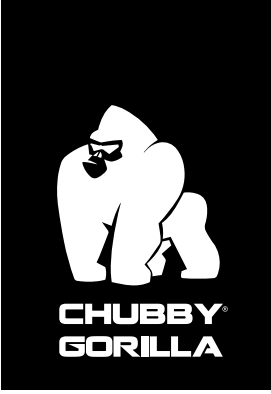

**AVIATOR® BOTTLE**

**SKU: CGAB1-16.5ML**

**LABEL SIZE SUGGESTION:**    **inch** | 2.59" W x 1.8" H    **mm** | 66 mm W x 45.72 mm H

**CAPACITY:**                      16.5 mL                      0.56 oz.

--- Safe area  
— Trim  
— Bleed

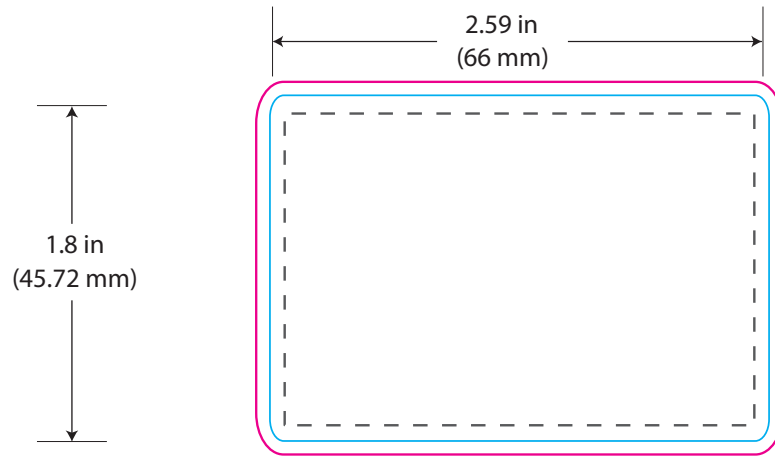

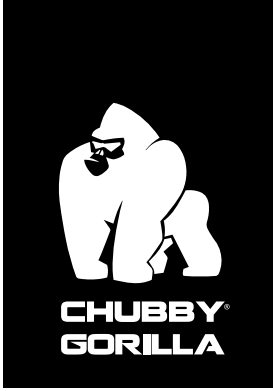

**AVIATOR® BOTTLE**

**SKU: CGAB1-20ML**

**LABEL SIZE SUGGESTION:**

**inch** | 2.59" W x 2.1" H

**mm** | 66 mm W x 53.34 mm H

**CAPACITY:**

20 mL

0.68 oz.



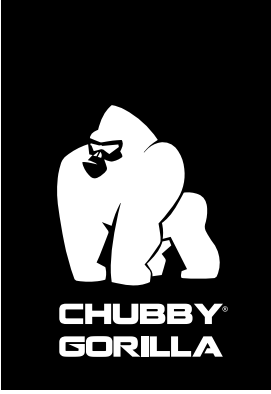

**AVIATOR® BOTTLE**

**SKU: CGAB1-20ML**

**LABEL SIZE SUGGESTION:**    **inch** | 2.59" W x 2.1" H    **mm** | 66 mm W x 53.34 mm H

**CAPACITY:**                      20 mL                              0.68 oz.

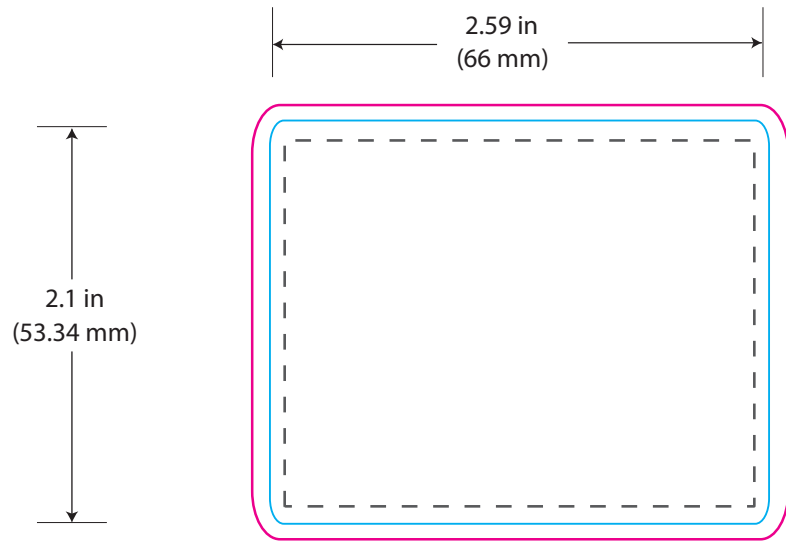
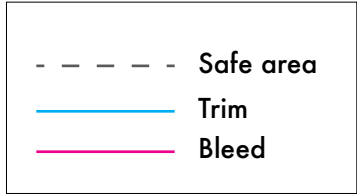



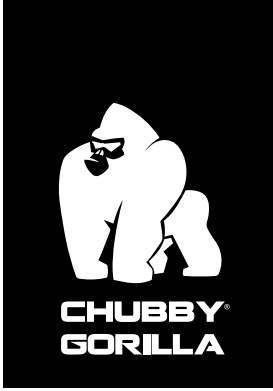

**AVIATOR® BOTTLE**

**SKU: CGAB1-30ML**

**LABEL SIZE SUGGESTION:**

**inch** | 2.6" W x 3.25" H

**mm** | 66.04 mm W x 82.55 mm H

**CAPACITY:**

30 mL

1.01 oz.

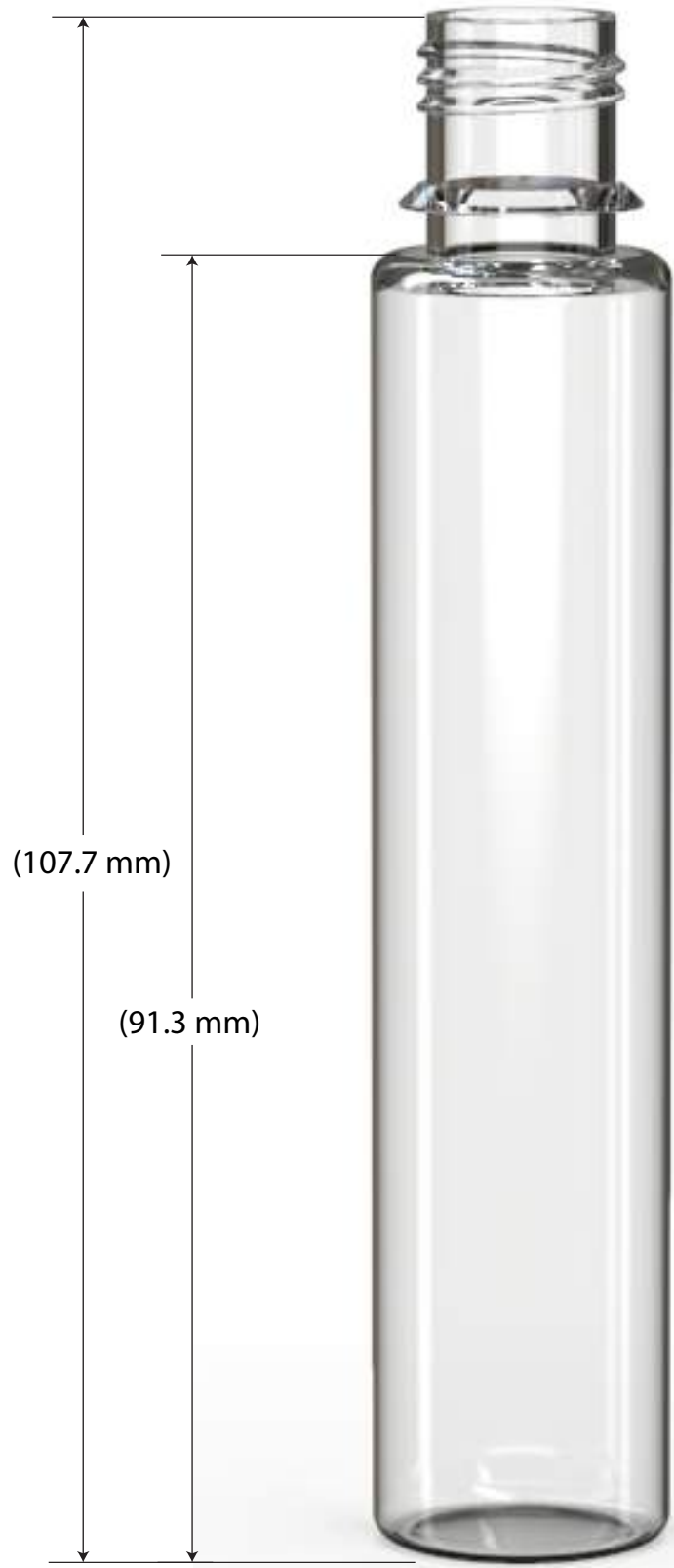
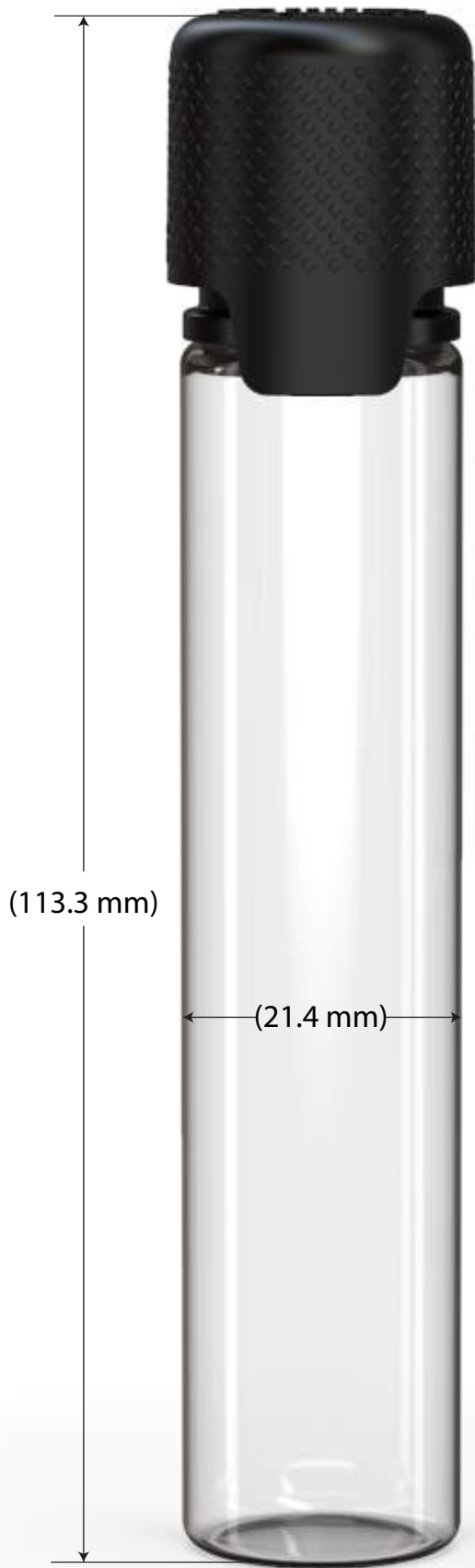
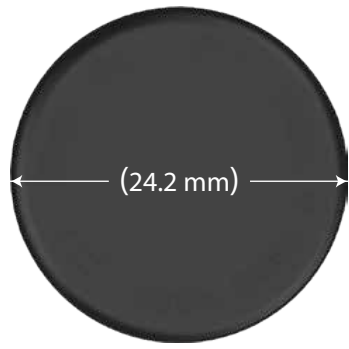

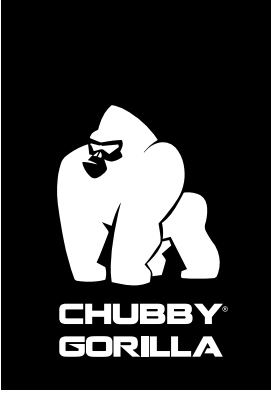

**AVIATOR® BOTTLE**

**SKU: CGAB1-30ML**

**LABEL SIZE SUGGESTION:**    **inch** | 2.6" W x 3.25" H    **mm** | 66.04 mm W x 82.55 mm H

**CAPACITY:**                      30 mL                      1.01 oz.

--- Safe area  
— Trim  
— Bleed

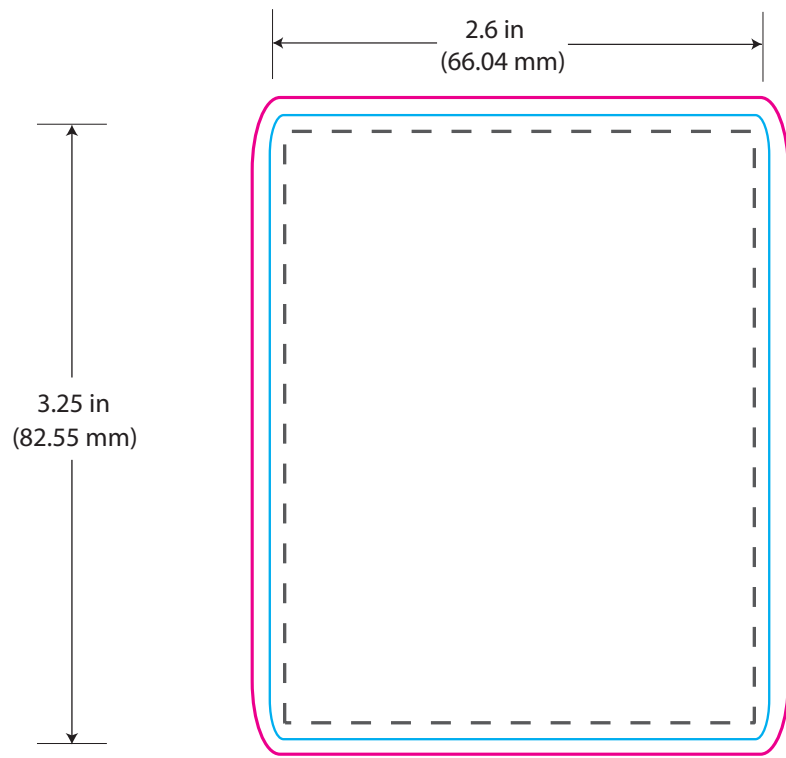

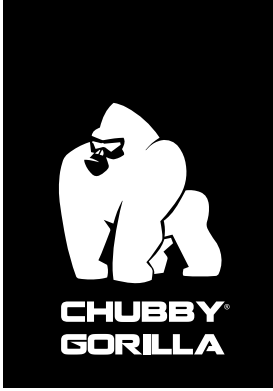

**AVIATOR® BOTTLE**

**SKU:** CGAB1-30MLSC

**LABEL SIZE SUGGESTION:**

**inch** | 3.65" W x 1.6" H

**mm** | 92.71 mm W x 40.64 mm H

**CAPACITY:**

30 mL

1.01 oz.

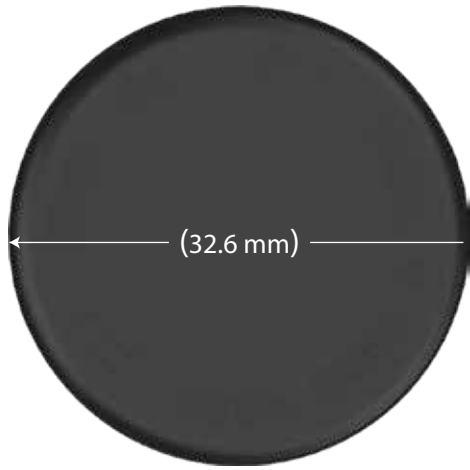



**AVIATOR® BOTTLE**

**SKU: CGAB1-30MLSC**

**LABEL SIZE SUGGESTION:**    **inch** | 3.65" W x 1.6" H    **mm** | 92.71 mm W x 40.64 mm H

**CAPACITY:**                      30 mL                      1.01 oz.

--- Safe area  
— Trim  
— Bleed

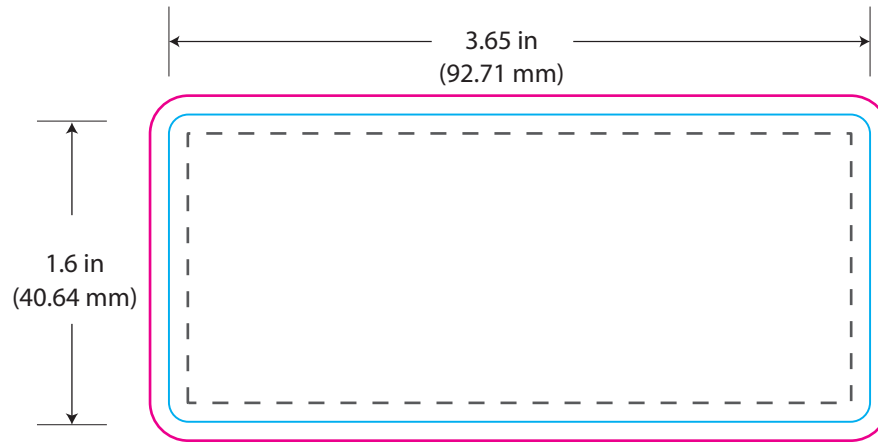

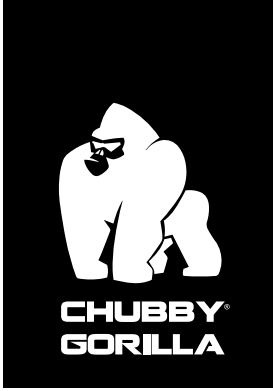

**AVIATOR® BOTTLE**

**SKU: CGAB1-50ML**

**LABEL SIZE SUGGESTION:**

**inch** | 3.65" W x 2.75" H | **mm** | 92.71 mm W x 69.85 mm H

**CAPACITY:**

50 mL

1.69 oz.

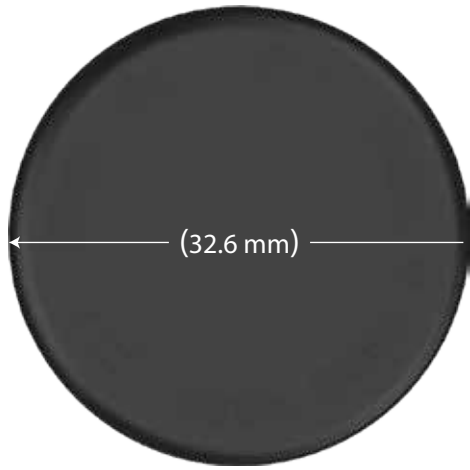

(32.6 mm)

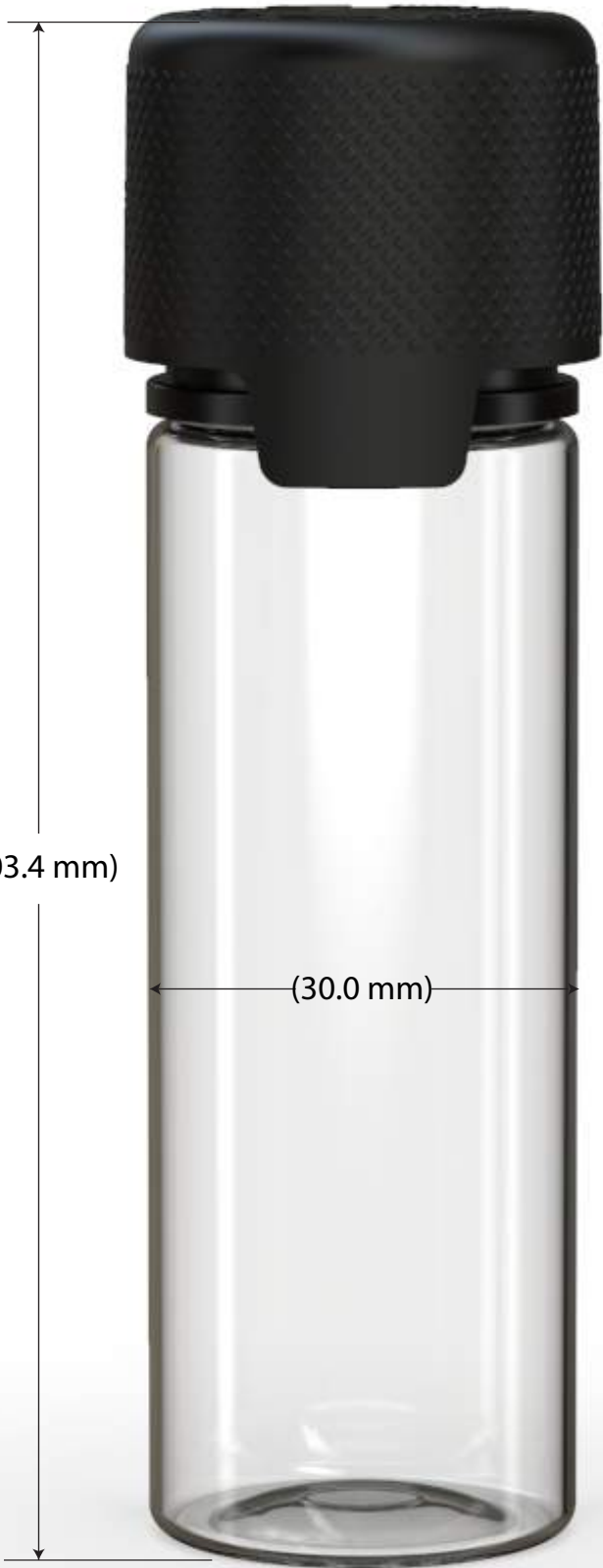

(103.4 mm)

(30.0 mm)



(96.4 mm)

(77.5 mm)



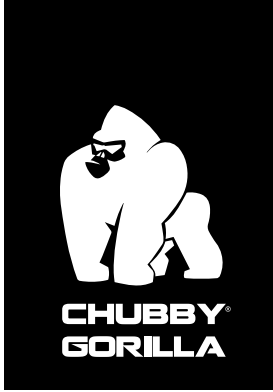

**AVIATOR® BOTTLE**

**SKU: CGAB1-50ML**

**LABEL SIZE SUGGESTION:**    **inch** | 3.65" W x 2.75" H    **mm** | 92.71 mm W x 69.85 mm H

**CAPACITY:**                      50 mL                      1.69 oz.

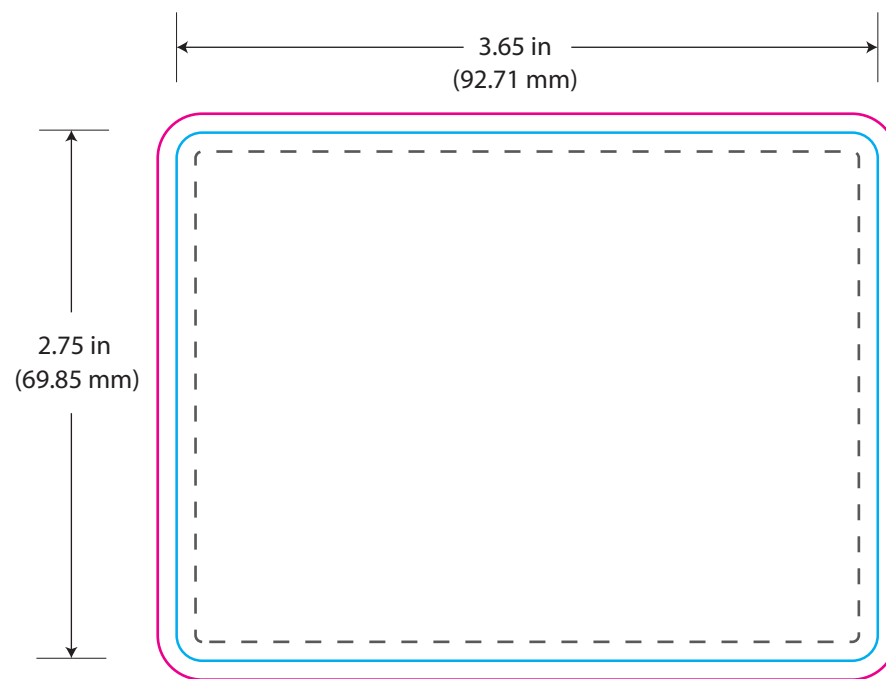
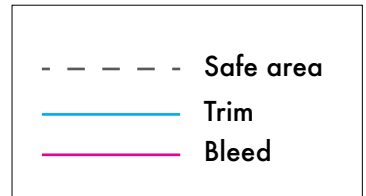

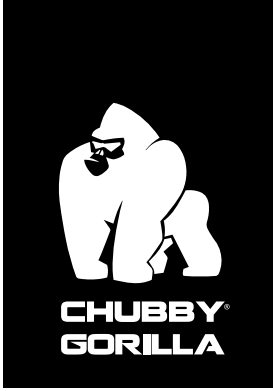

**AVIATOR® BOTTLE**

**SKU: CGAB1-60ML**

**LABEL SIZE SUGGESTION:**

**inch** | 3.65" W x 3.25" H    **mm** | 92.71 mm W x 82.55 mm H

**CAPACITY:**

60 mL

2.03 oz.



**AVIATOR® BOTTLE**

CGAB1-60ML

Label guide →

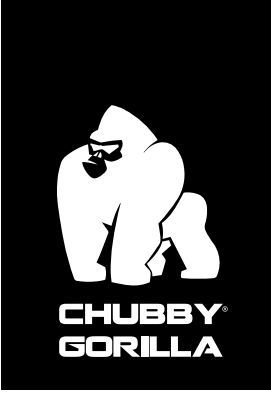

**AVIATOR® BOTTLE**

**SKU:** CGAB1-60ML

**LABEL SIZE SUGGESTION:**    **inch** | 3.65" W x 3.25" H    **mm** | 92.71 mm W x 82.55 mm H

**CAPACITY:**                      60 mL                      2.03 oz.

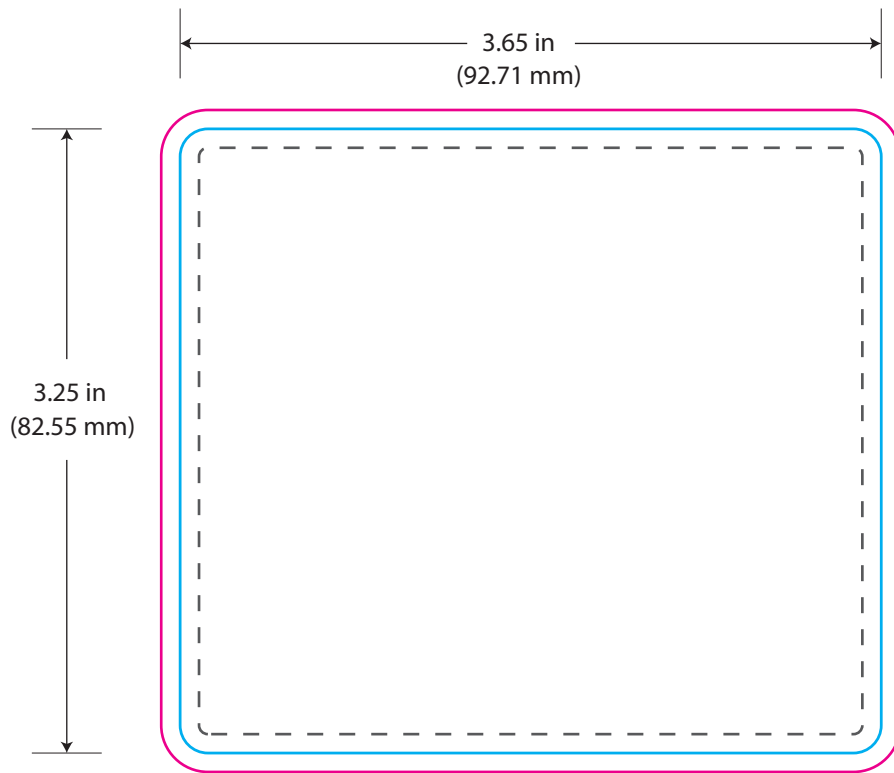
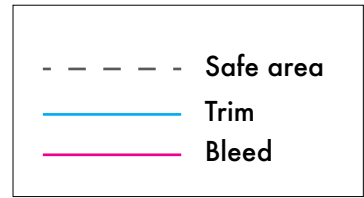



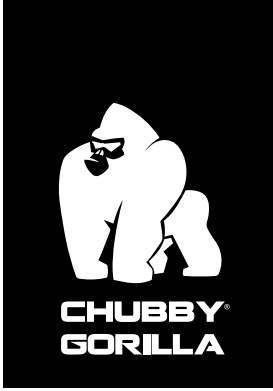

**AVIATOR® BOTTLE**

**SKU:** CGAB1-60MLM

**LABEL SIZE SUGGESTION:**

**inch** | 4.4" W x 1.9" H

**mm** | 117 mm W x 48 mm H

**CAPACITY:**

60 mL

2.03 oz.

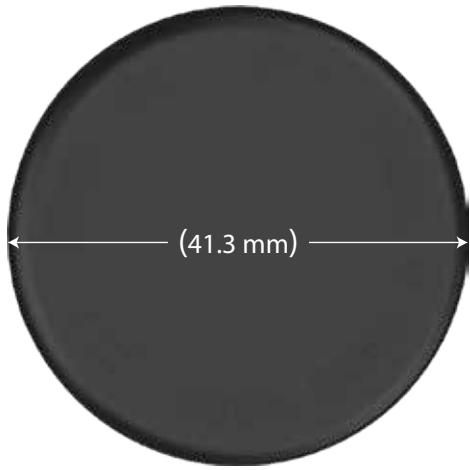



**AVIATOR® BOTTLE**

**SKU: CGAB1-60MLM**

**LABEL SIZE SUGGESTION:**    **inch** | 4.4" W x 1.9" H       **mm** | 117 mm W x 48 mm H

**CAPACITY:**                      60 mL                      2.03 oz.

--- Safe area  
— Trim  
— Bleed

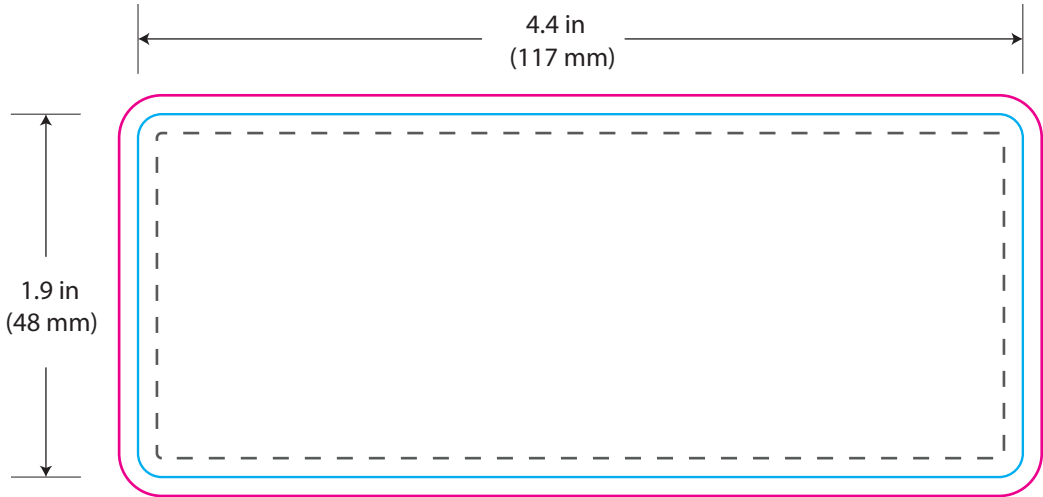

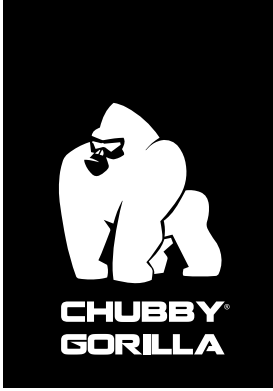

**AVIATOR® BOTTLE**

**SKU:** CGAB1-100ML

**LABEL SIZE SUGGESTION:**

**inch** | 5" W x 2.75" H

**mm** | 127 mm W x 70 mm H

**CAPACITY:**

100 mL

3.38 oz.





**AVIATOR® BOTTLE**

**SKU: CGAB1-100ML**

**LABEL SIZE SUGGESTION:**    **inch** | 5" W x 2.75" H                      **mm** | 127 mm W x 70 mm H

**CAPACITY:**                      100 mL.                      3.38 oz.

- - - - - Safe area  
— Trim  
— Bleed

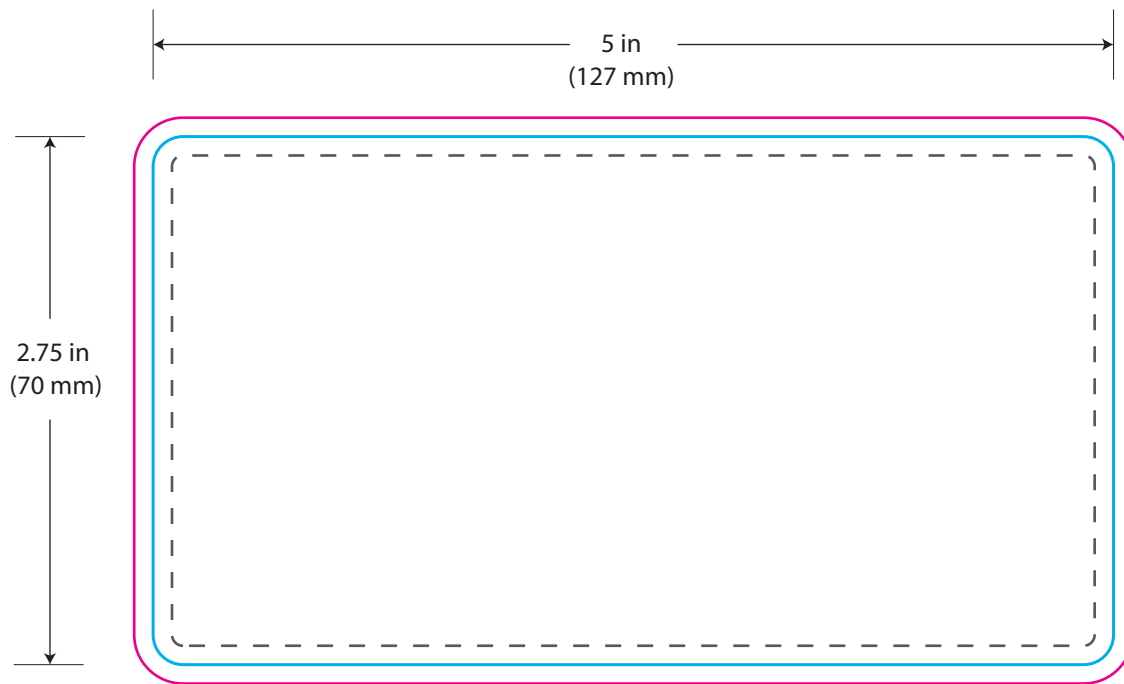

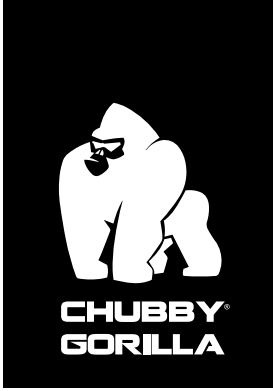

**AVIATOR® BOTTLE**

**SKU:** CGAB1-120ML

**LABEL SIZE SUGGESTION:**

**inch** | 5.0" W x 3.25" H

**mm** | 127 mm W x 82.55 mm H

**CAPACITY:**

120 mL

4.06 oz.



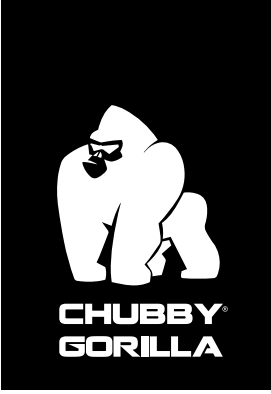

**AVIATOR® BOTTLE**

**SKU: CGAB1-120ML**

**LABEL SIZE SUGGESTION:**    **inch** | 5.0" W x 3.25" H    **mm** | 127 mm W x 82.55 mm H

**CAPACITY:**                      120 mL                      4.06 oz.

--- Safe area  
— Trim  
— Bleed

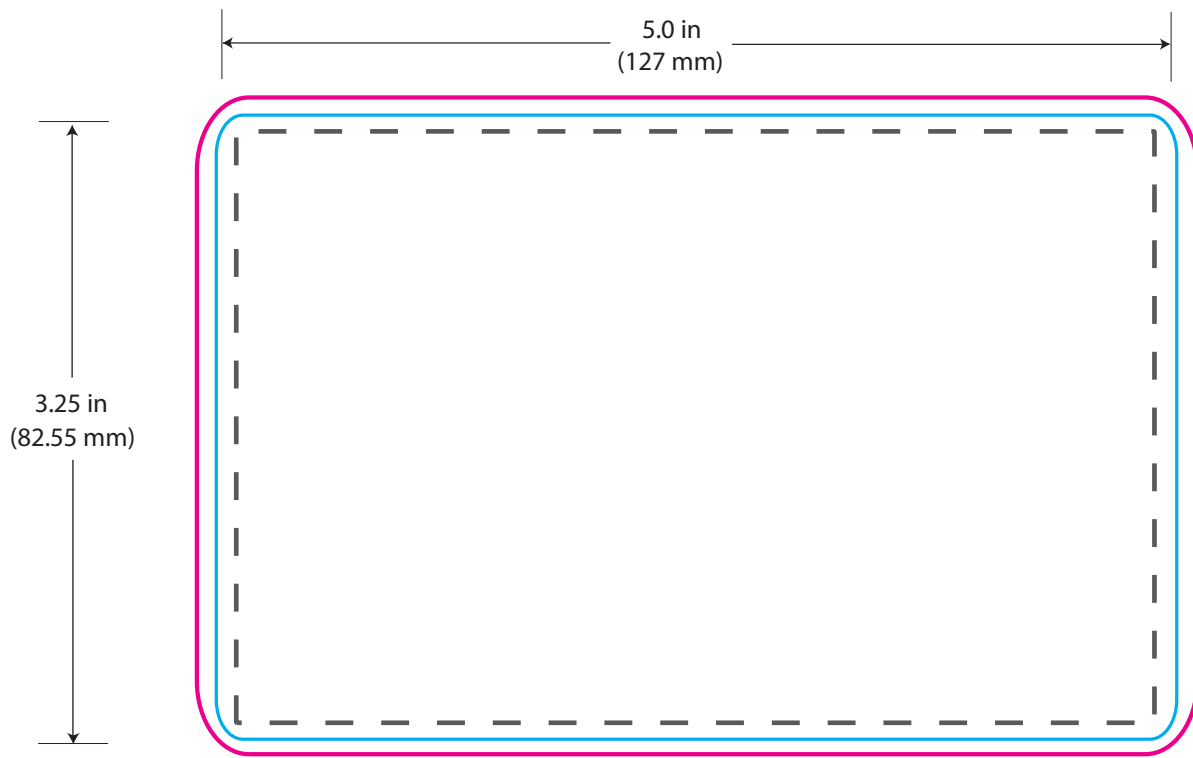

# AVIATOR® TUBES

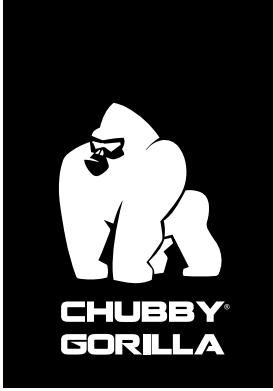

**AVIATOR® TUBE**

**SKU: CGAT6-100MM**

**LABEL SIZE SUGGESTION:**

**inch** | 2.44" W x 3" H

**mm** | 62 mm W x 76.2 mm H

**CAPACITY:**

0.44 oz.

13 mL

13 cc

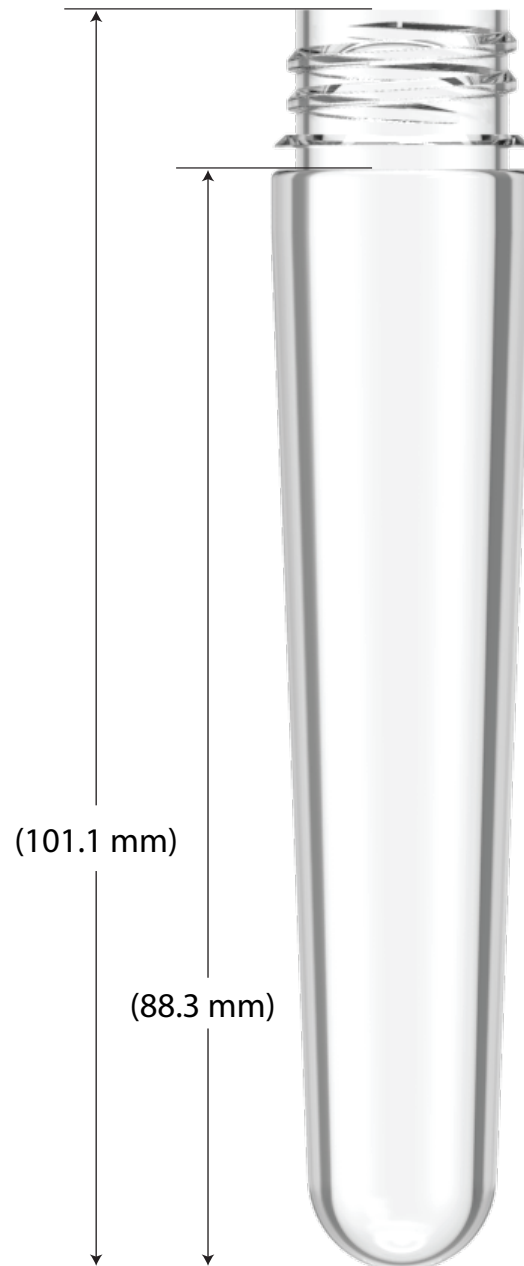
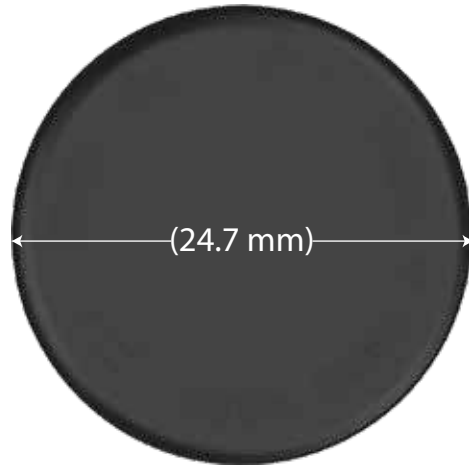

**AVIATOR® TUBE**

**CGAT6-100MM**

**Label guide** →



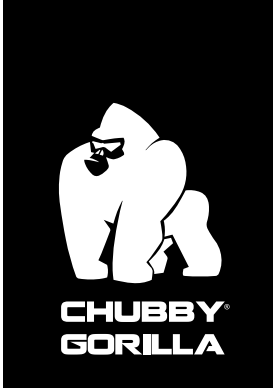

**AVIATOR® TUBE**

**SKU: CGAT6-100MM**

**LABEL SIZE SUGGESTION:**    **inch** | 2.44" W x 3" H                      **mm** | 62 mm W x 76.2 mm H

**CAPACITY:**                      0.44 oz.                      13 mL                      13 cc

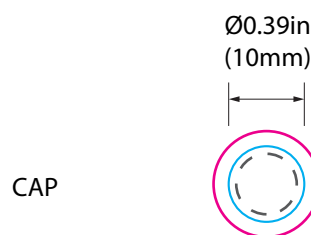
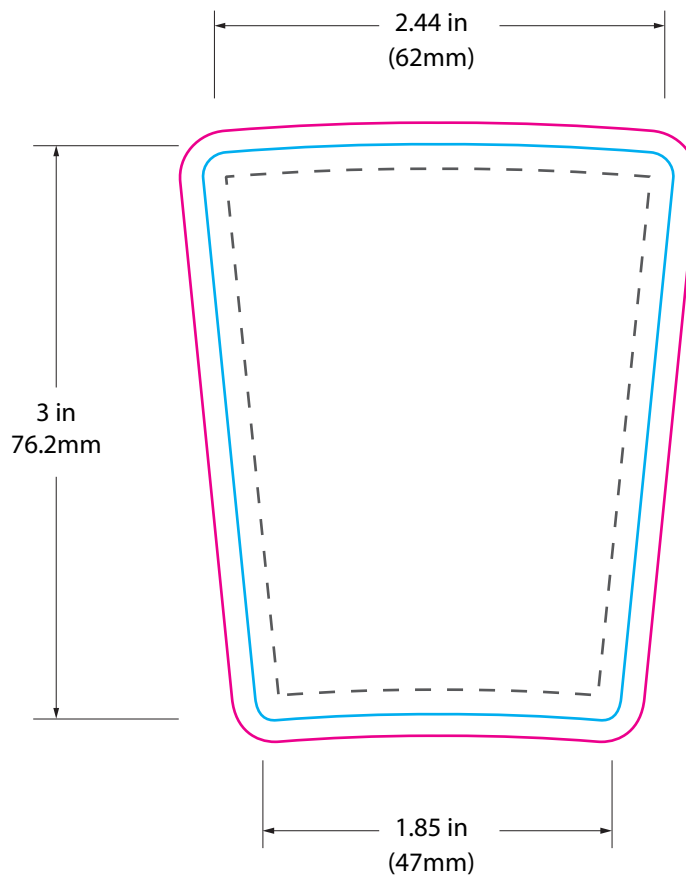
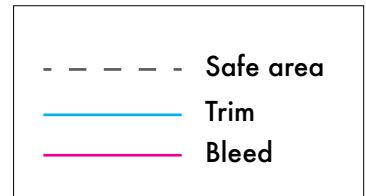

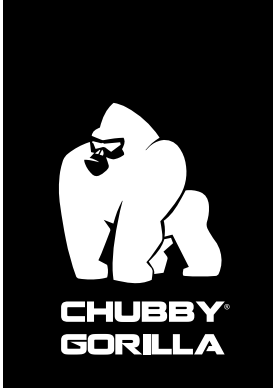

**AVIATOR® TUBE**

**SKU: CGAT1-100MMF**

**LABEL SIZE SUGGESTION:**

**inch** | 2.48" W x 3.54" H

**mm** | 63 mm W x 90 mm H

**CAPACITY:**

TBA

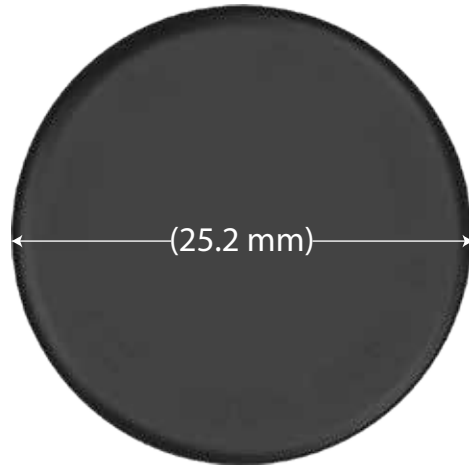

**AVIATOR® TUBE**

**CGAT1-100MMF**

**Label guide** →

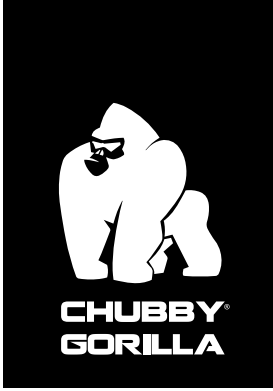

**AVIATOR® TUBE**

**SKU: CGAT1-100MMF**

**LABEL SIZE SUGGESTION:**

**inch** | 2.48" W x 3.54" H

**mm** | 63 mm W x 90 mm H

**CAPACITY:**

TBA

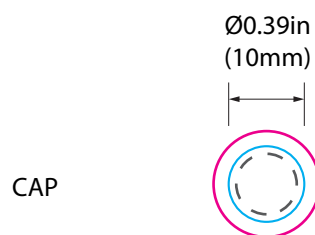
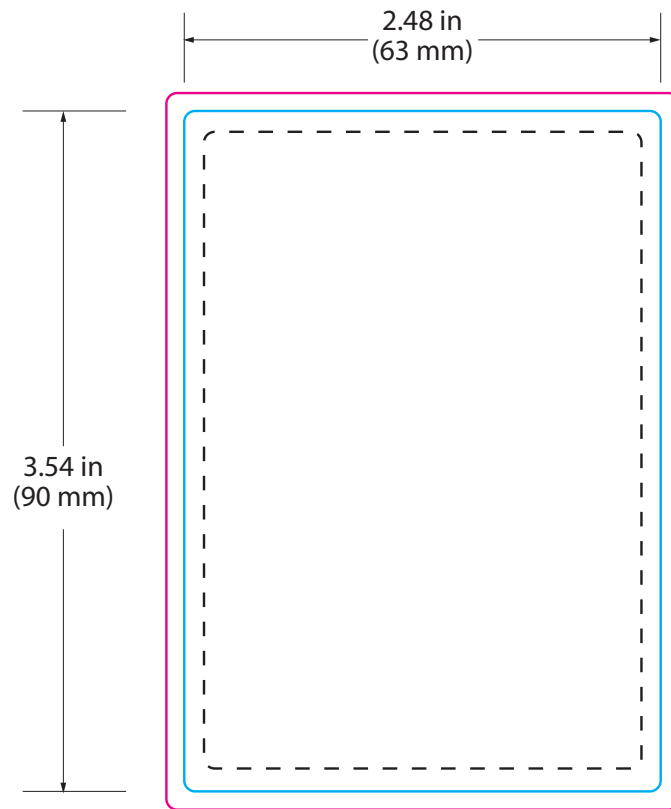
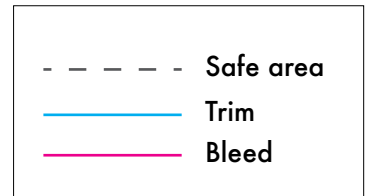

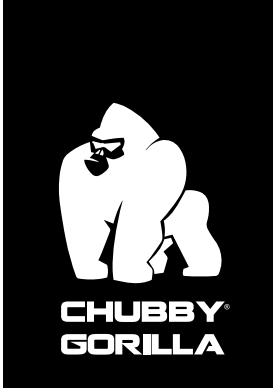

**AVIATOR® TUBE**

**SKU: CGAT6-113MM**

**LABEL SIZE SUGGESTION:**

**inch** | 2.36" W x 3.57" H

**mm** | 60 mm W x 90.8 mm H

**CAPACITY:**

0.34 oz.

10 mL

10 cc

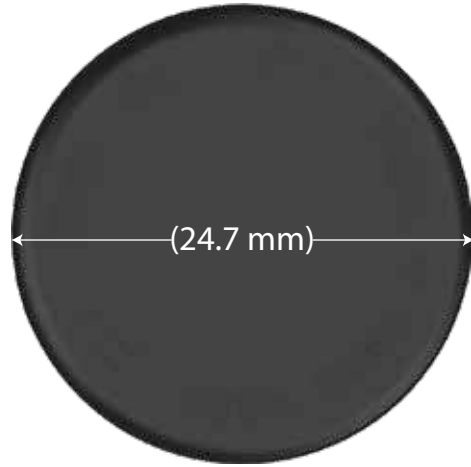

**AVIATOR® TUBE**

**CGAT6-113MM**

**Label guide** →

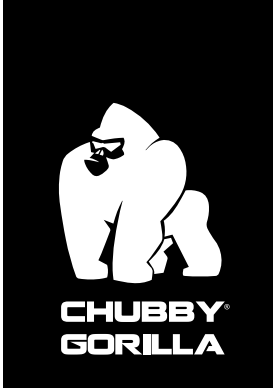

**AVIATOR® TUBE**

**SKU: CGAT6-113MM**

**LABEL SIZE SUGGESTION:**    **inch** | 2.36" W x 3.57" H    **mm** | 60 mm W x 90.8 mm H

**CAPACITY:**                      0.34 oz.                      10 mL                      10 cc

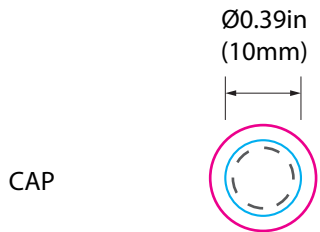
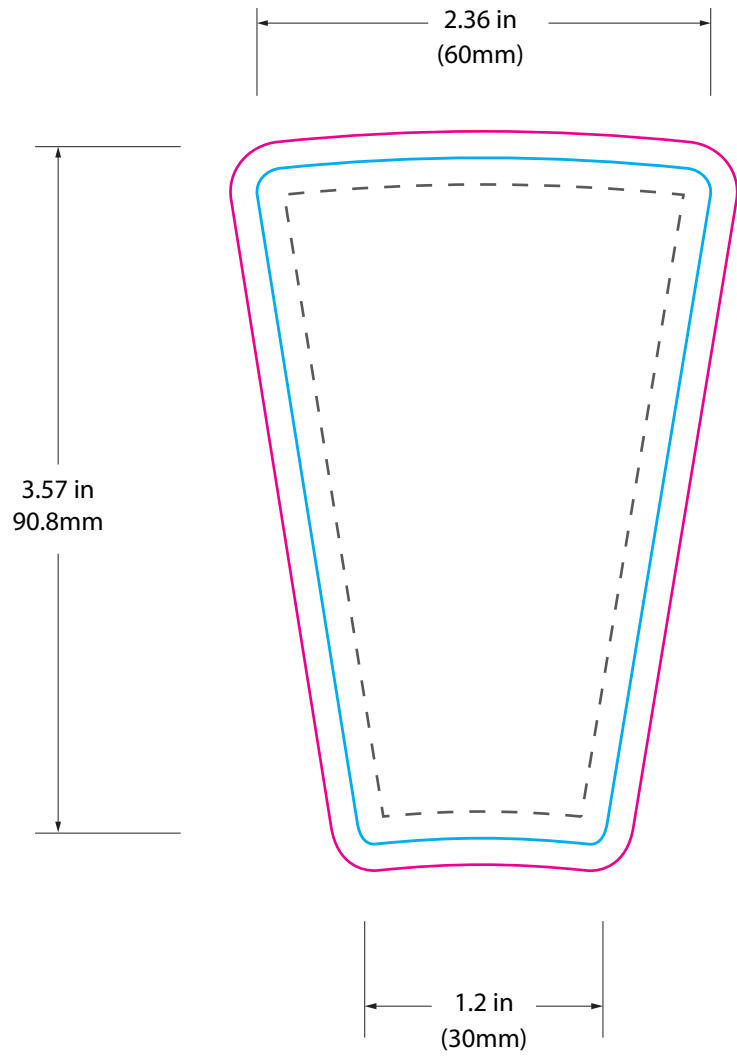
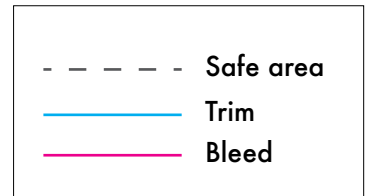

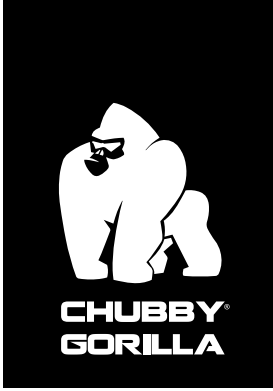

**AVIATOR® TUBE**

**SKU: CGAT6-120MM**

**LABEL SIZE SUGGESTION:**

**inch** | 2.43" W x 3.75" H

**mm** | 61.87 mm W x 95.26 mm H

**CAPACITY:**

0.61 oz.

18 mL

18 cc

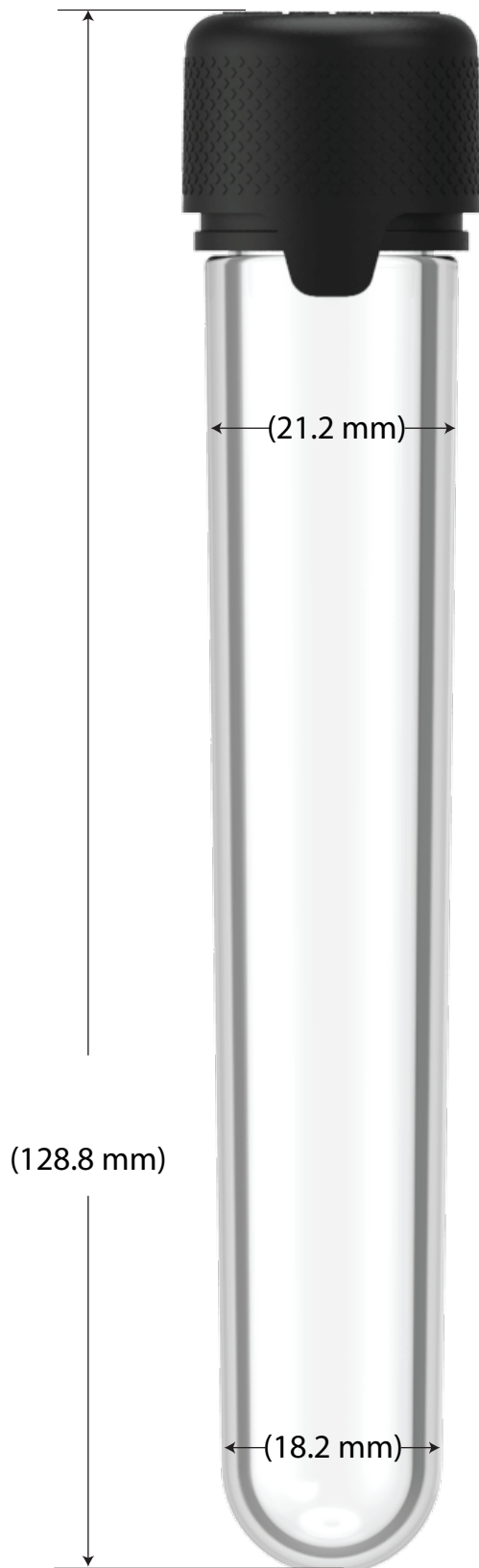
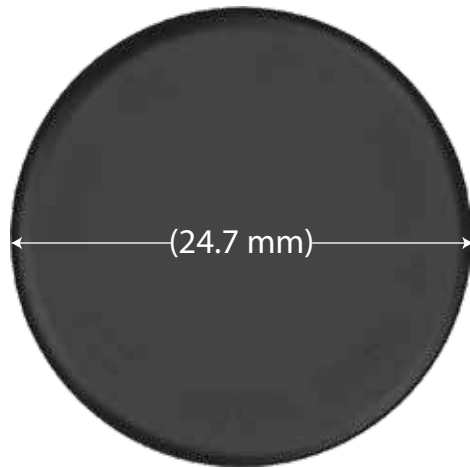

**AVIATOR® TUBE**

**CGAT6-120MM**

**Label guide** →

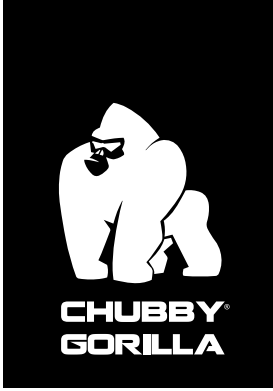

**AVIATOR® TUBE**

**SKU: CGAT6-120MM**

**LABEL SIZE SUGGESTION:**    **inch** | 2.43" W x 3.75" H    **mm** | 61.87 mm W x 95.26 mm H

**CAPACITY:**                      0.61 oz.                      18 mL                      18 cc

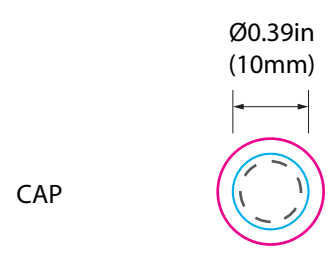
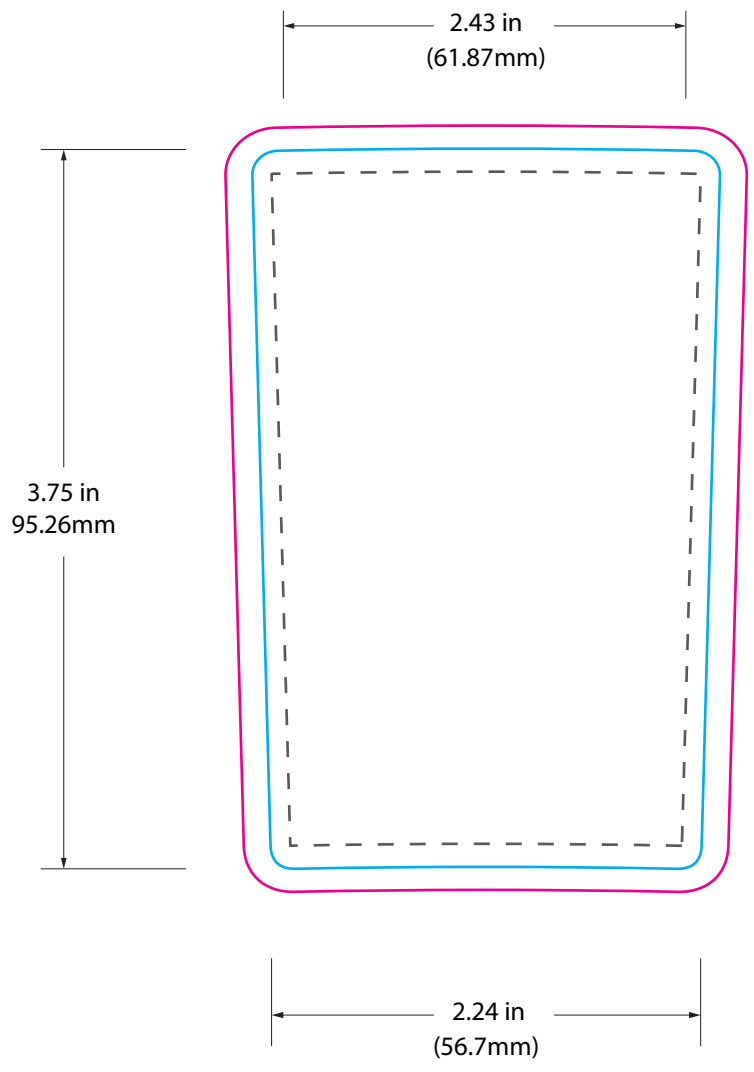
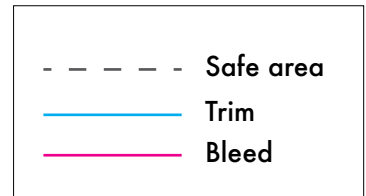

# AVIATOR® CARTRIDGE CONTAINERS







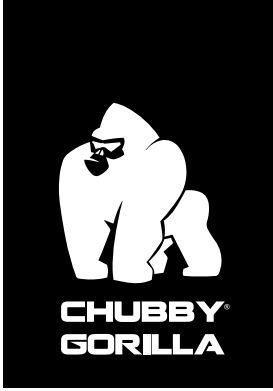

**AVIATOR® 510 CARTRIDGE CONTAINER**

**SKU: CGAC1-510F**

**LABEL SIZE SUGGESTION:**

**inch** | 2.36" W x 2.17" H

**mm** | 60 mm W x 55 mm H

**CAPACITY:**

65 mm





# AVIATOR® BASE BOTTLES

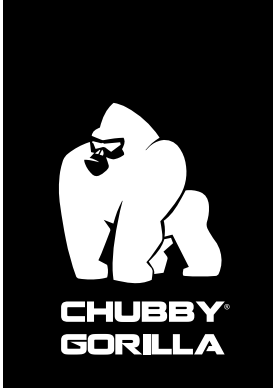

**AVIATOR® BASE BOTTLE**

**SKU: CGABB1-250ML**

**LABEL SIZE SUGGESTION:**

**inch** | 9.84" W x 1.77" H

**mm** | 250 mm W x 45 mm H

**CAPACITY:**

250 mL

8.45 oz.



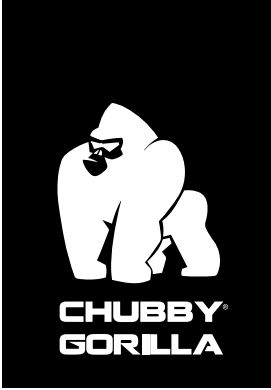

**AVIATOR® BASE BOTTLE**

**SKU: CGABB1-250ML**

**LABEL SIZE SUGGESTION:**

**inch** | 9.84" W x 1.77" H

**mm** | 250 mm W x 45 mm H

**CAPACITY:**

250 mL

8.45 oz.

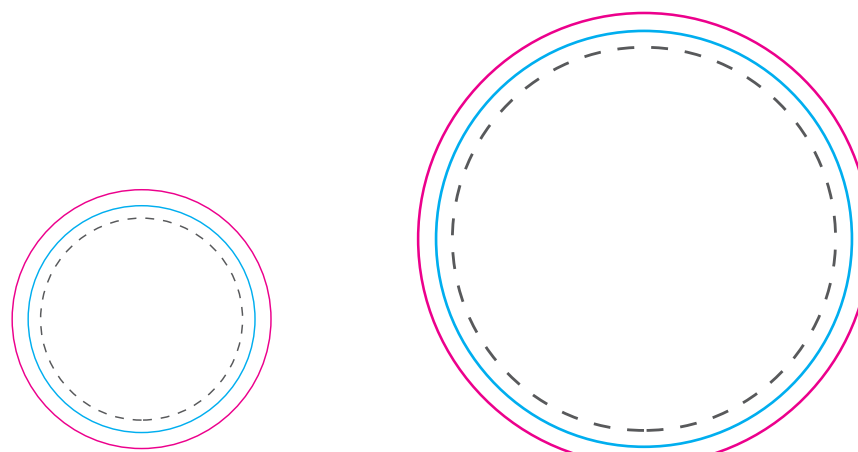
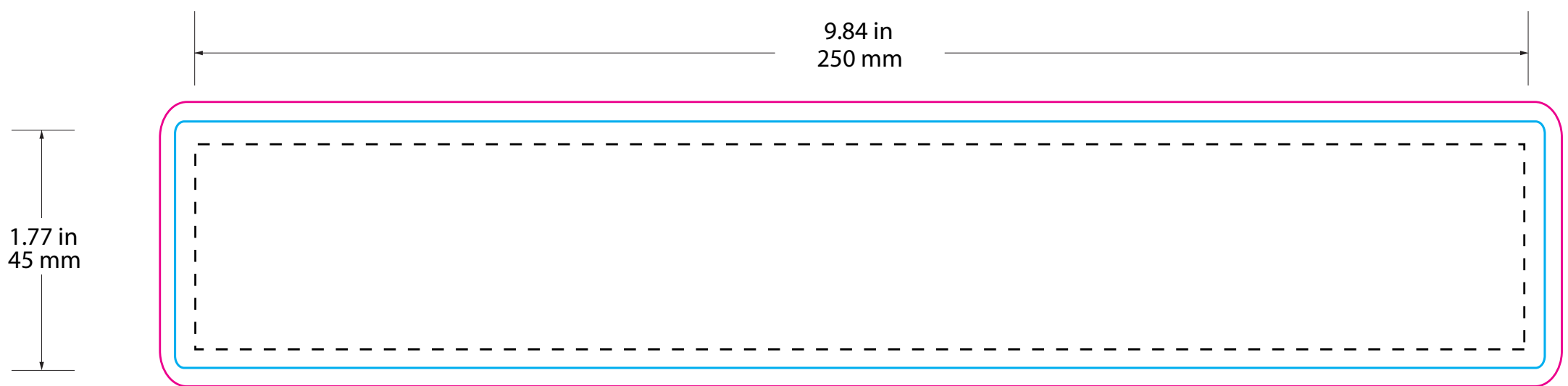
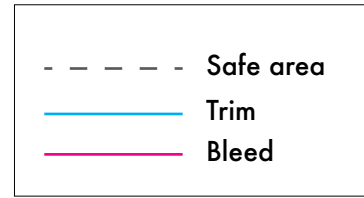

Ø1.18 in  
(30 mm)

INNER CLOSURE

Ø2.16 in  
(55 mm)

OUTER CLOSURE



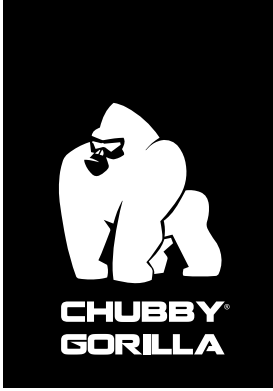

**AVIATOR® BASE BOTTLE**

**SKU: CGABB1-500ML**

**LABEL SIZE SUGGESTION:**

**inch** | 9.84" W x 3.54" H

**mm** | 250 mm W x 90 mm H

**CAPACITY:**

500 mL

16.90 oz.





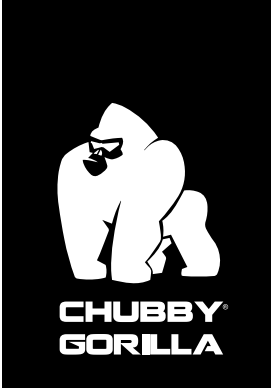

**AVIATOR® BASE BOTTLE**

**SKU:** CGABB1-500ML

**LABEL SIZE SUGGESTION:**

**inch** | 9.84" W x 3.54" H

**mm** | 250 mm W x 90 mm H

**CAPACITY:**

500 mL

16.90 oz.

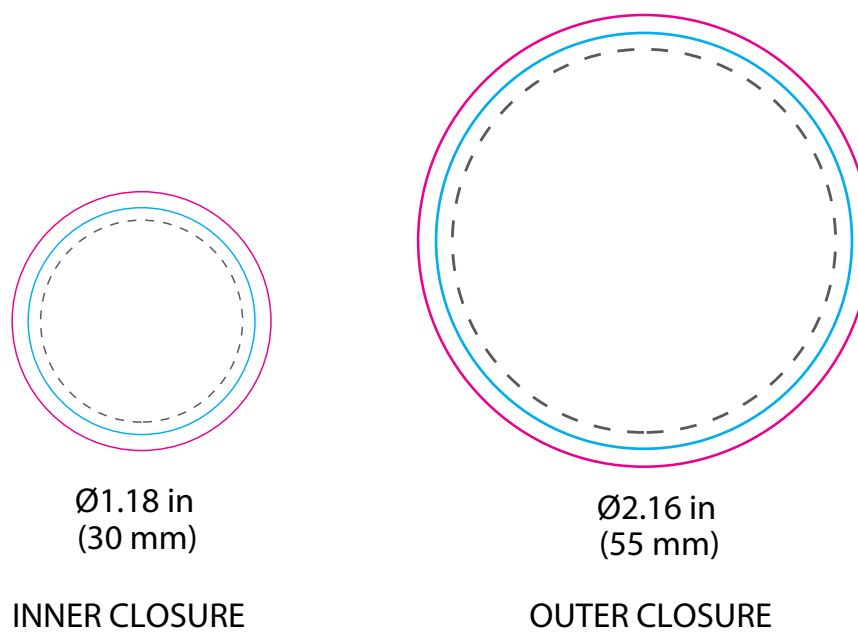
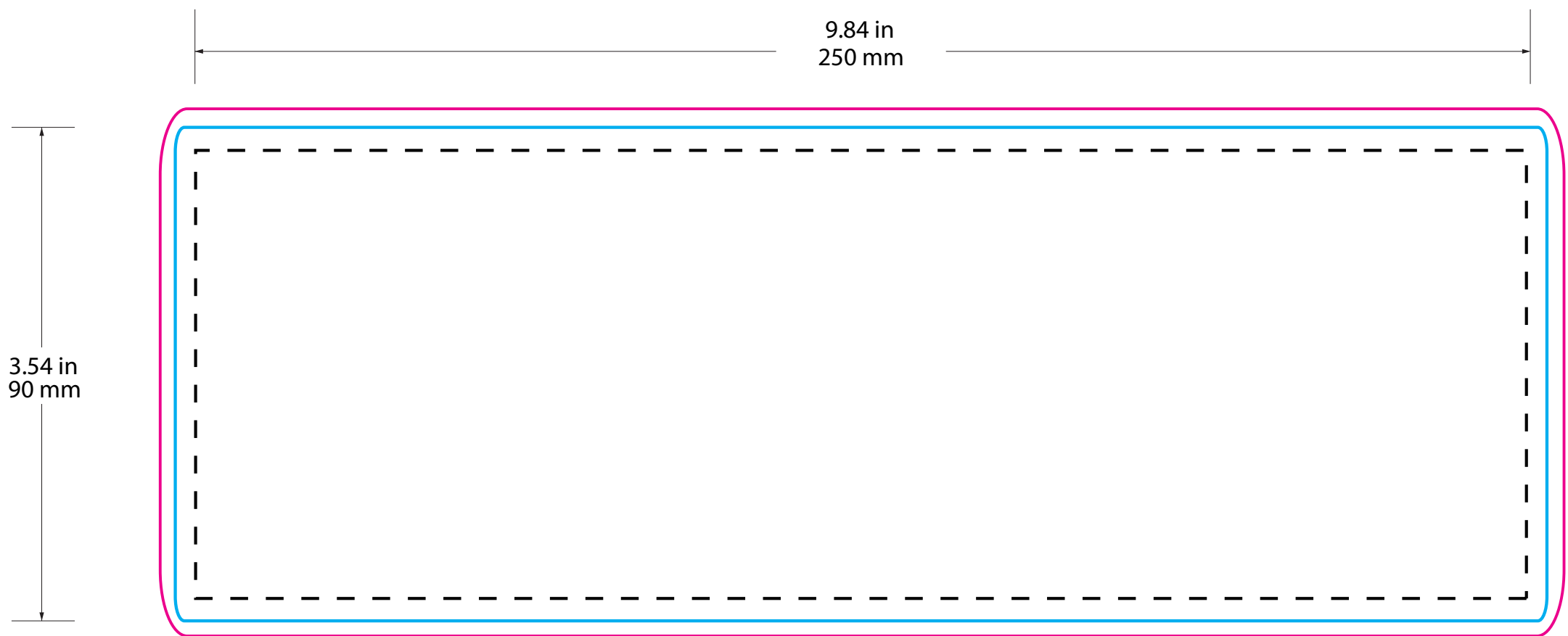
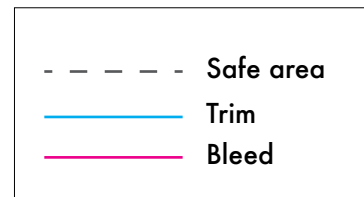

**AVIATOR® BASE BOTTLE**

CGABB1-500ML

500 mL

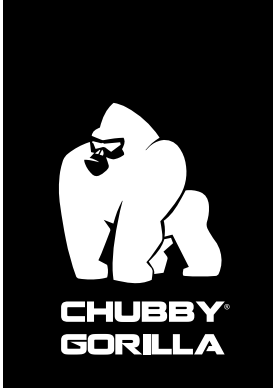

**AVIATOR® BASE BOTTLE**

**SKU:** CGABB1-1L

**LABEL SIZE SUGGESTION:**

**inch** | 9.84" W x 7.67" H

**mm** | 250 mm W x 195 mm H

**CAPACITY:**

1 L

33.81 oz.

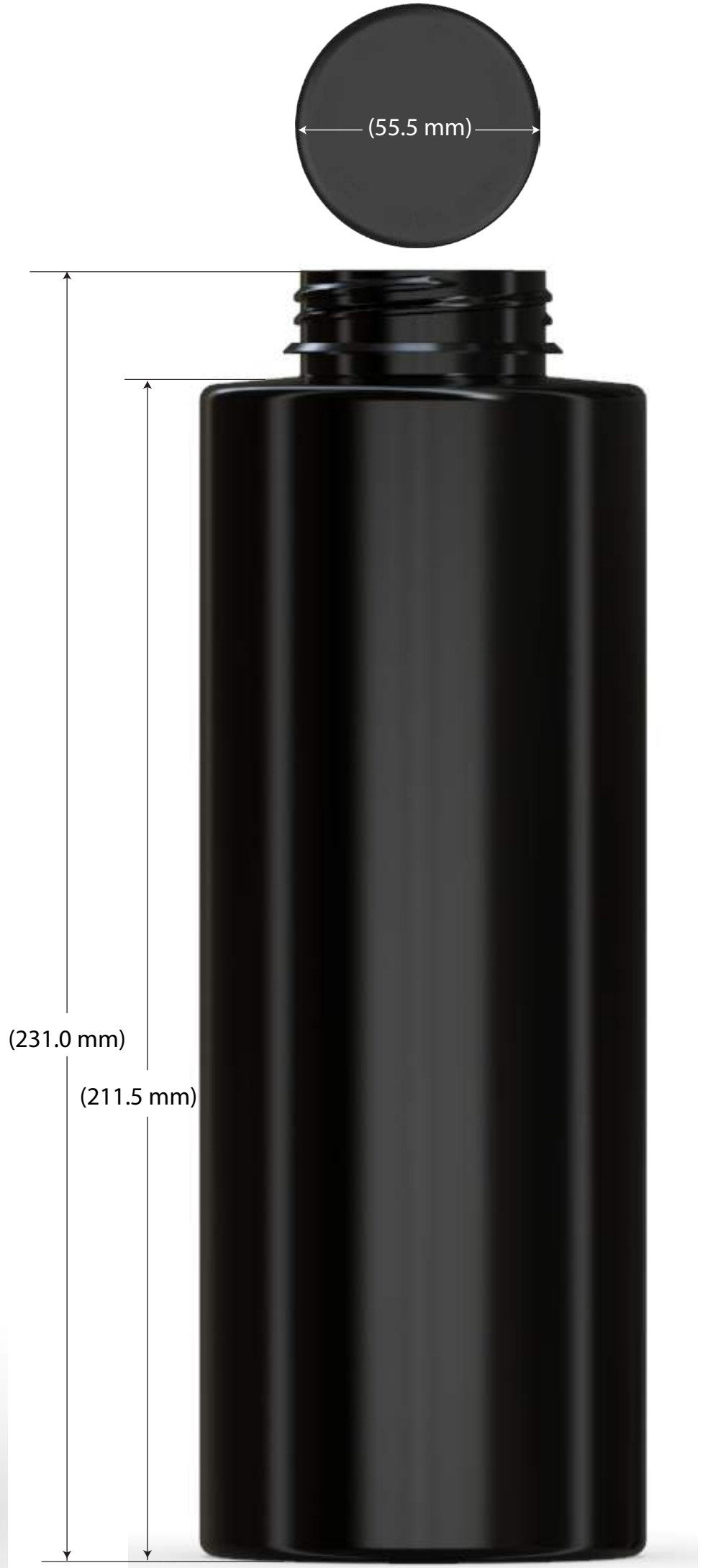
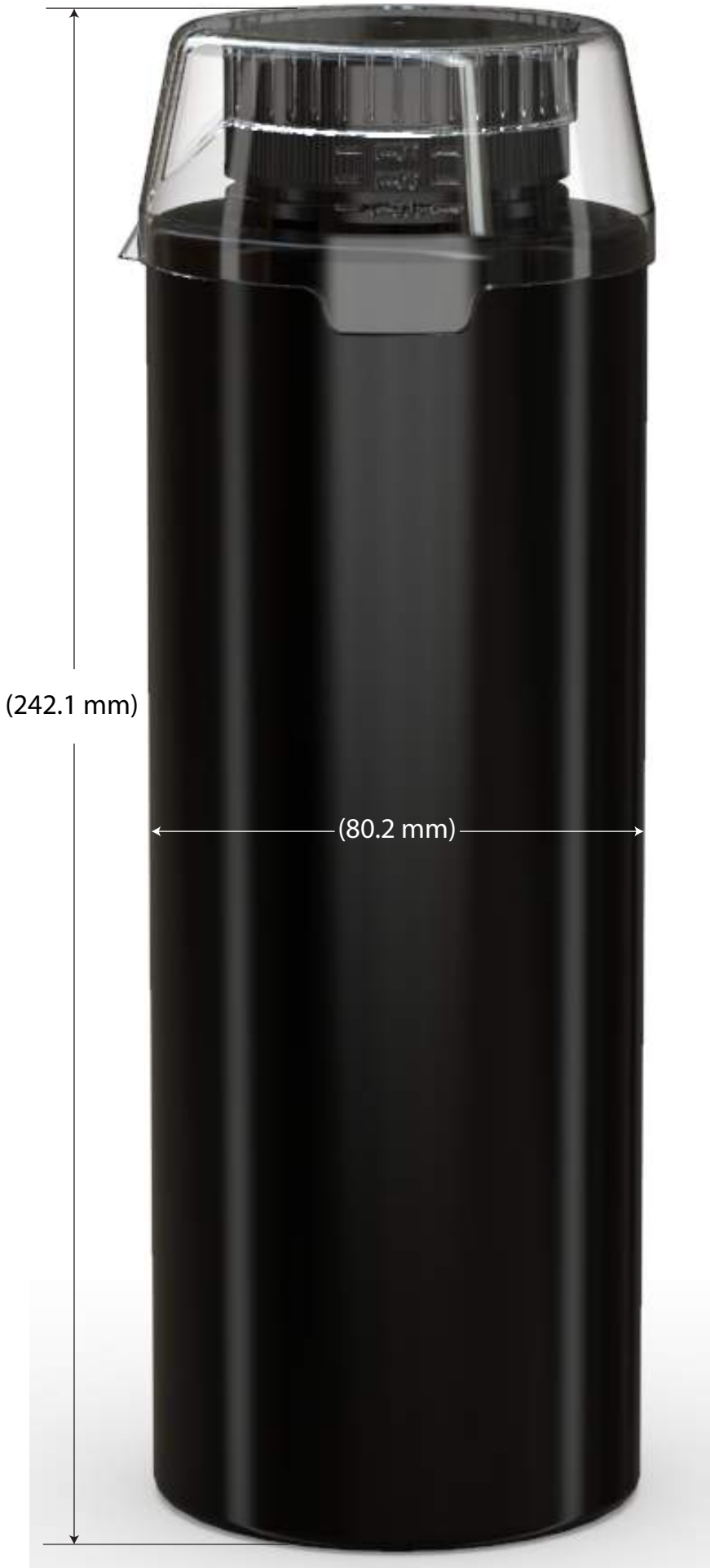

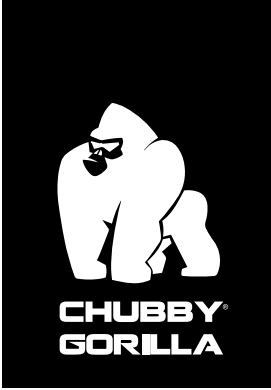

**AVIATOR® BASE BOTTLE**

**SKU: CGABB1-1L**

**LABEL SIZE SUGGESTION:**

**inch** | 9.84" W x 7.67" H

**mm** | 250 mm W x 195 mm H

**CAPACITY:**

1 L

33.81 oz.

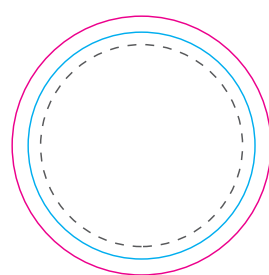
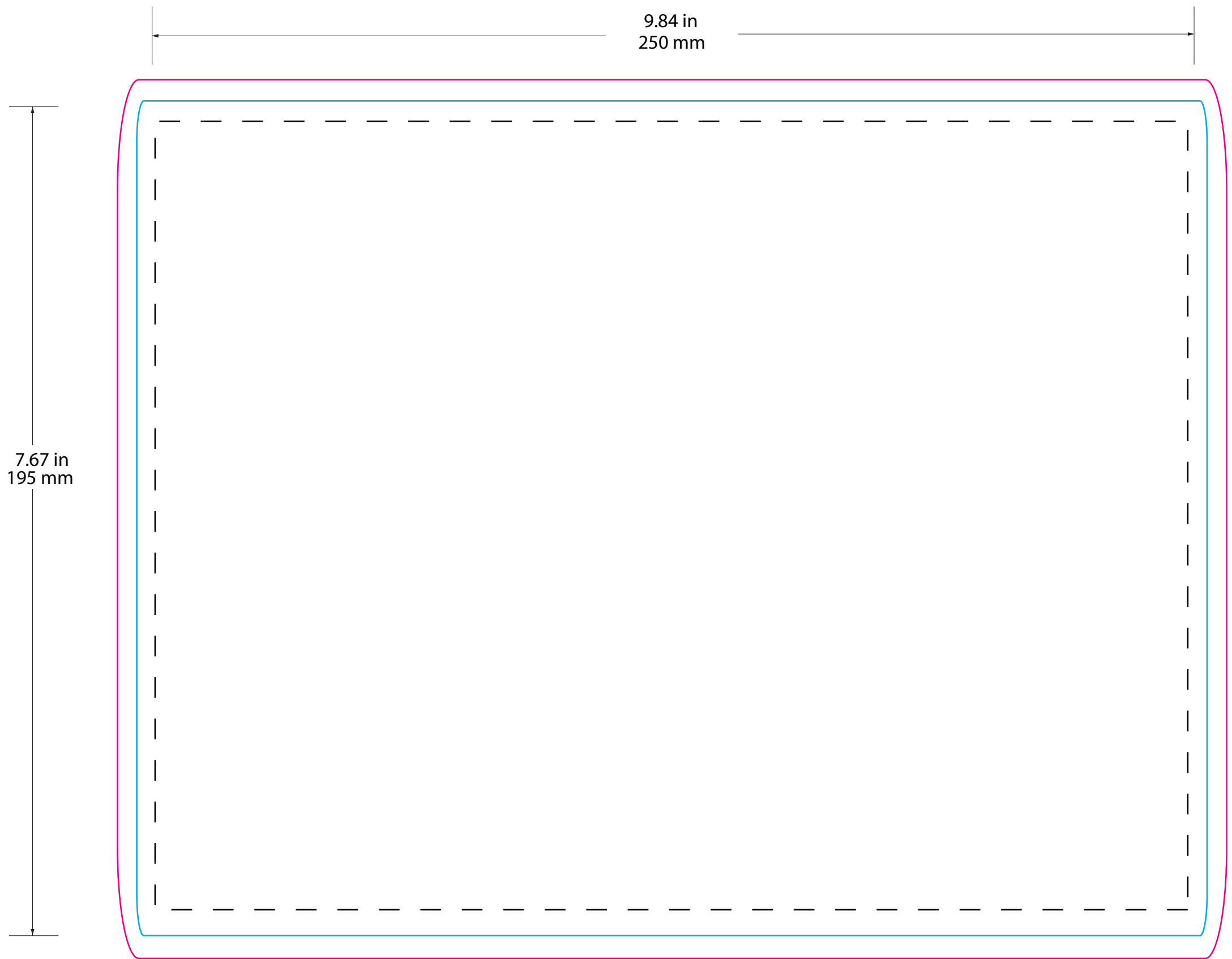

Ø1.18 in  
(30 mm)

INNER CLOSURE

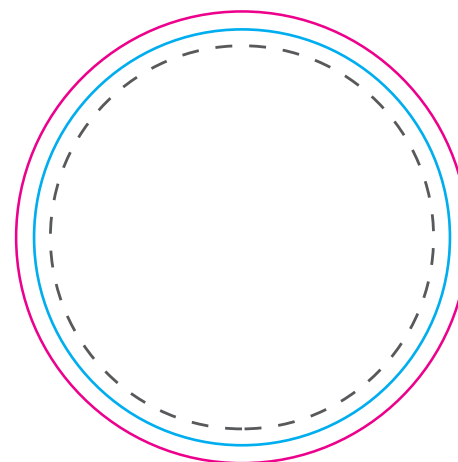

Ø2.16 in  
(55 mm)

OUTER CLOSURE

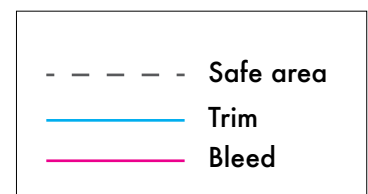



## A SPECIALTY PACKAGING COMPANY

CHUBBY GORILLA® IS A SPECIALTY PACKAGING MANUFACTURER,  
ENGINEERING SOLUTIONS FOR EMERGING INDUSTRIES ACROSS THE GLOBE.

**GLOBAL HEADQUARTERS**  
**CHUBBY GORILLA INC.,**  
4320 NORTH HARBOR BLVD,  
FULLERTON, CA. 92835, USA  
+1 (844) 365 - 5218 | +1 (714) 253 - 3512

**CHUBBY GORILLA EUROPE BV**  
SMITSPOL 4A  
NIJKERK, 3861 RS  
NETHERLANDS  
[WWW.CHUBBYGORILLA.COM](http://WWW.CHUBBYGORILLA.COM)

DESIGNED IN ORANGE COUNTY, CALIFORNIA, U.S.A | © 2022 CHUBBY GORILLA INC. - ALL RIGHTS RESERVED

**CHUBBY GORILLA, THE FIGURATIVE GORILLA LOGO AND OTHER MARKS ARE REGISTERED, PENDING OR UNREGISTERED TRADEMARKS AND/OR COPYRIGHTS OF CHUBBY GORILLA, INC. IN THE U.S. AND/OR OTHER COUNTRIES. THESE PRODUCTS MAY BE COVERED BY ONE OR MORE PATENTS OR PATENT APPLICATIONS, SEE [WWW.CHUBBYGORILLA.COM/PATENTS](http://WWW.CHUBBYGORILLA.COM/PATENTS)**

**PRODUCT USE:** MANY FACTORS BEYOND CHUBBY GORILLA'S ("CG") CONTROL AND UNIQUELY WITHIN USER'S KNOWLEDGE AND CONTROL CAN AFFECT THE USE AND PERFORMANCE OF A CG PRODUCT IN A PARTICULAR APPLICATION. GIVEN THE VARIETY OF FACTORS THAT CAN AFFECT THE USE AND PERFORMANCE OF A CG PRODUCT, USER IS SOLELY RESPONSIBLE FOR EVALUATING THE CG PRODUCT AND DETERMINING WHETHER IT IS FIT FOR A PARTICULAR PURPOSE AND SUITABLE FOR USER'S METHOD OF APPLICATION, INCLUDING BUT NOT LIMITED TO, DETERMINING WHETHER THE PRODUCT(S) PLACED WITHIN ITS PACKAGING SOLUTIONS ARE COMPATIBLE WITH EACH PARTICULAR PACKAGING SOLUTION.

**WARRANTY, LIMITED REMEDY, AND DISCLAIMER:** UNLESS AN ADDITIONAL WARRANTY IS SPECIFICALLY STATED ON THE APPLICABLE CG PRODUCT PACKAGING OR PRODUCT LITERATURE, CG WARRANTS THAT EACH CG PRODUCT MEETS THE APPLICABLE CG PRODUCT SPECIFICATION AT THE TIME CG SHIPS THE PRODUCT. CHUBBY GORILLA MAKES NO OTHER WARRANTIES OR CONDITIONS, EXPRESS OR IMPLIED, INCLUDING, BUT NOT LIMITED TO, ANY IMPLIED WARRANTY OR CONDITION OF MERCHANTABILITY OR FITNESS FOR A PARTICULAR PURPOSE OR ANY IMPLIED WARRANTY OR CONDITION ARISING OUT OF A COURSE OF DEALING, CUSTOM OR USAGE OF TRADE. IF THE CG PRODUCT DOES NOT CONFORM TO THIS WARRANTY, THEN THE SOLE AND EXCLUSIVE REMEDY IS, AT CG'S OPTION, REPLACEMENT OF THE CG PRODUCT OR REFUND OF THE PURCHASE PRICE.

**LIMITATION OF LIABILITY:** EXCEPT WHERE PROHIBITED BY LAW, CG WILL NOT BE LIABLE FOR ANY LOSS OR DAMAGE ARISING FROM THE CG PRODUCT, WHETHER DIRECT, INDIRECT, SPECIAL, INCIDENTAL OR CONSEQUENTIAL, REGARDLESS OF THE LEGAL THEORY ASSERTED, INCLUDING WARRANTY, CONTRACT, NEGLIGENCE OR STRICT LIABILITY.