



AVIATOR®

CONTAINERS, XL CONTAINERS, BOTTLES,
TUBES, CARTRIDGE CONTAINERS and BASE BOTTLES

**DIMENSION &
LABEL SUGGESTION GUIDE**

AVIATOR® CONTAINERS

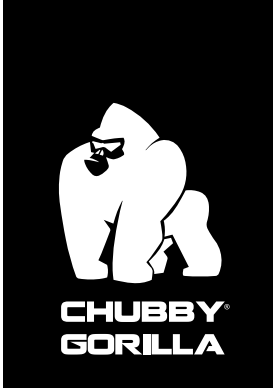

AVIATOR® CONTAINER

SKU: CGAC1-1OZ

LABEL SIZE SUGGESTION:

inch | 6.1" W x 0.47" H

mm | 155 mm W x 12 mm H

CAPACITY:

1 oz.

30 mL

30 cc

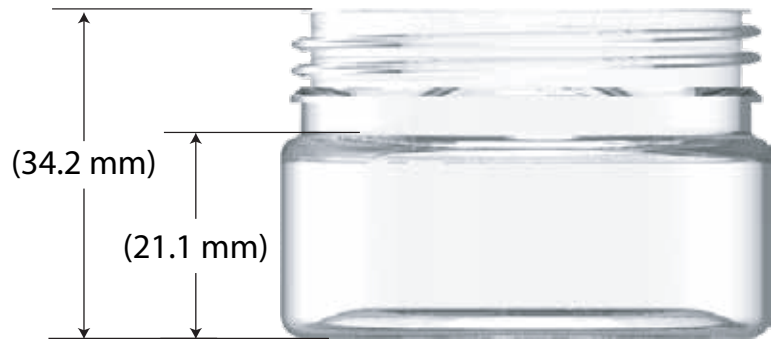
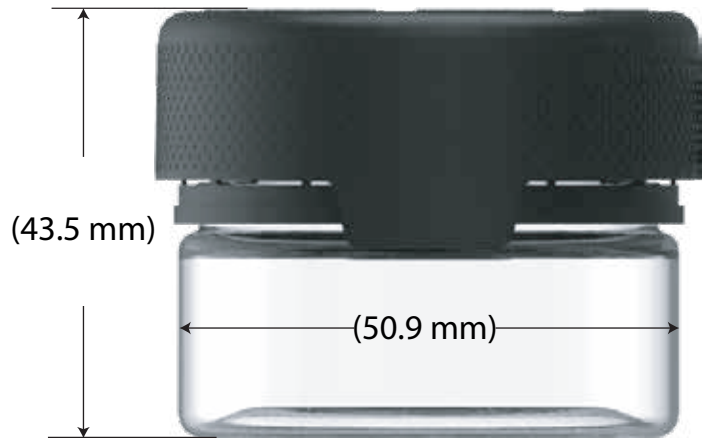

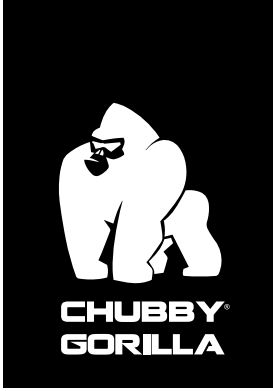

AVIATOR® CONTAINER

SKU: CGAC1-1OZ

LABEL SIZE SUGGESTION:

inch | 6.1" W x 0.47" H

mm | 155 mm W x 12 mm H

CAPACITY:

1 oz.

30 mL

30 cc

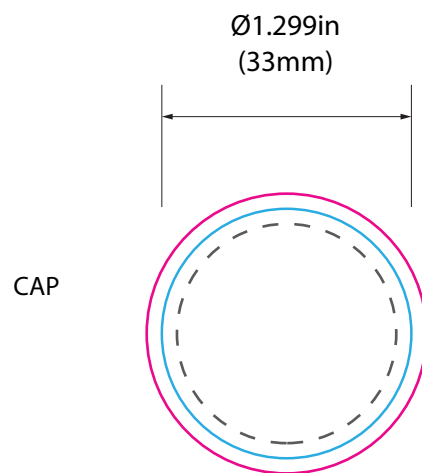
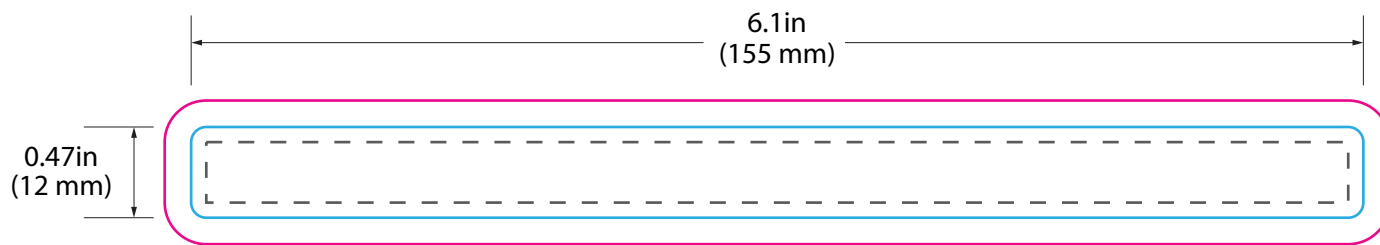
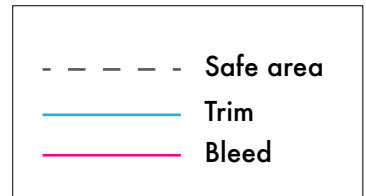

AVIATOR® CONTAINER

CGAC1-1OZ

1 oz.

Please note that the label template may not be to scale. For accurate sizing and verification, refer to the dimension specifications. The provided label guides are for suggestion purposes only, and labels can be adjusted as needed.

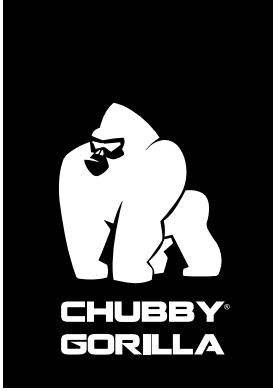

AVIATOR® CONTAINER

SKU: CGAC1-2OZ

LABEL SIZE SUGGESTION:

inch | 6.1" W x 1.22" H

mm | 155 mm W x 31 mm H

CAPACITY:

2 oz.

60 mL

60 cc

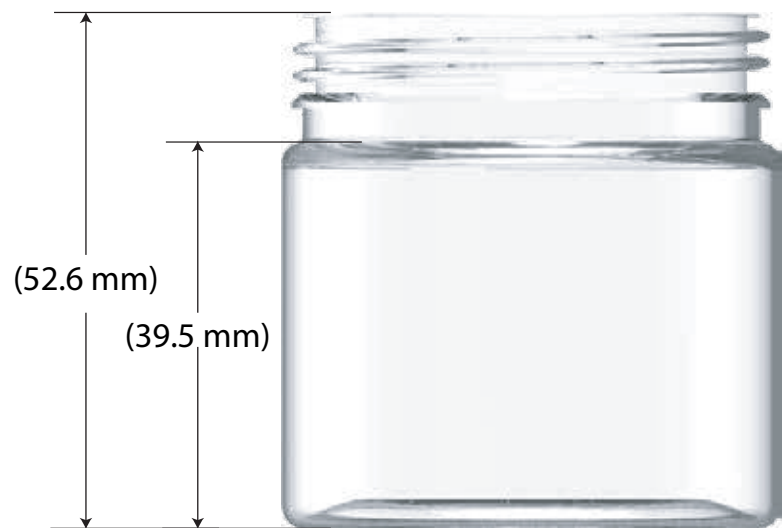
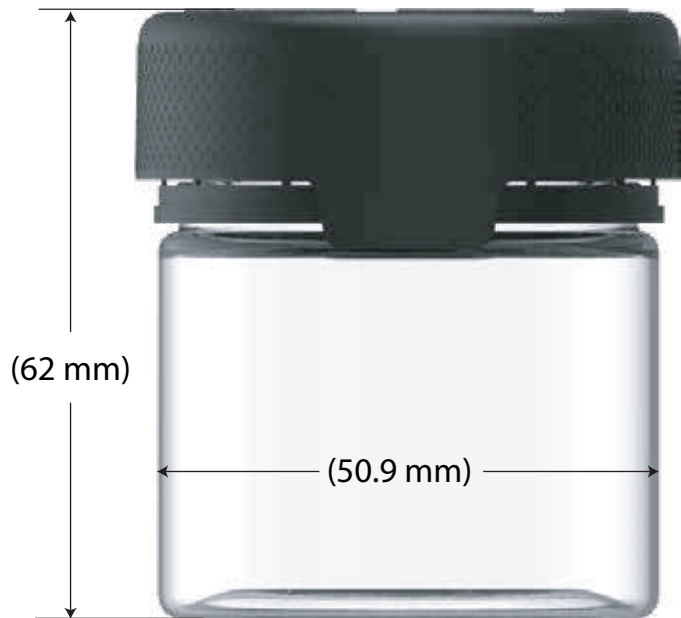
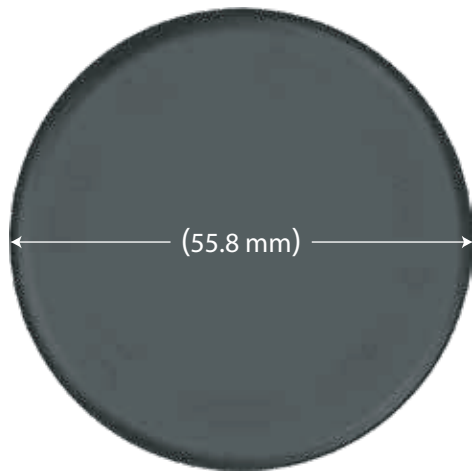

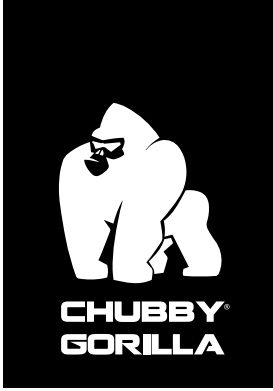

AVIATOR® CONTAINER

SKU: CGAC1-2OZ

LABEL SIZE SUGGESTION: **inch** | 6.1" W x 1.22" H **mm** | 155 mm W x 31 mm H

CAPACITY: 2 oz. 60 mL 60 cc

--- Safe area
— Trim
— Bleed

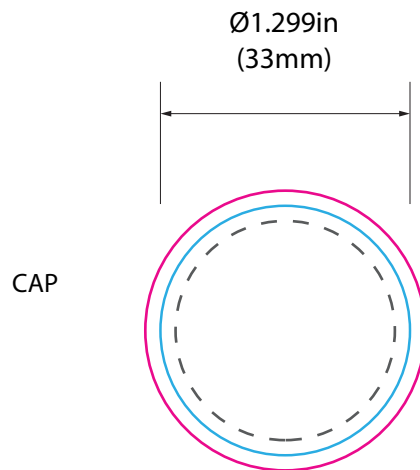
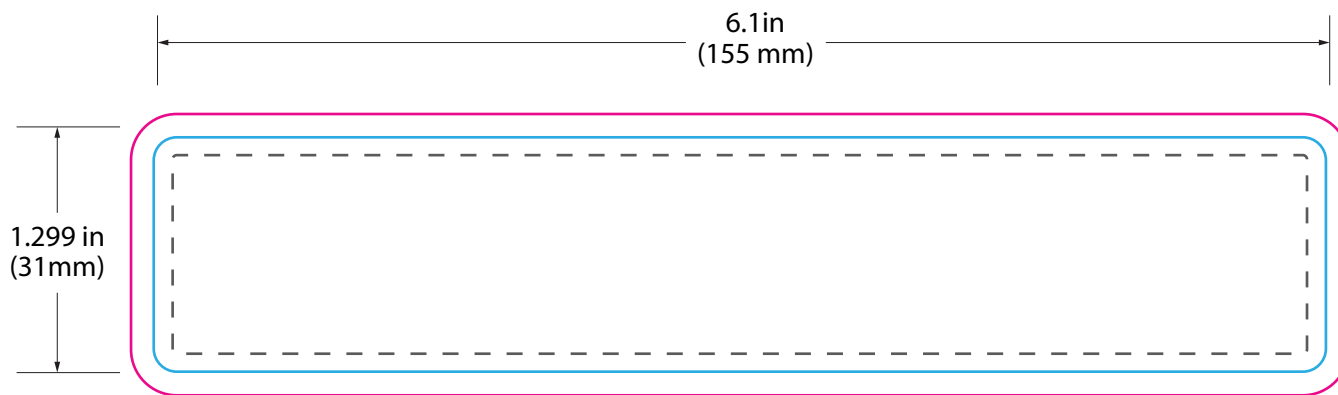

AVIATOR® CONTAINER

CGAC1-2OZ

2 oz.

Please note that the label template may not be to scale. For accurate sizing and verification, refer to the dimension specifications. The provided label guides are for suggestion purposes only, and labels can be adjusted as needed.

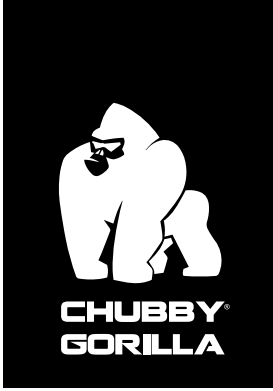

AVIATOR® CONTAINER

SKU: CGAC1-3OZ

LABEL SIZE SUGGESTION:

inch | 6.1" W x 1.456" H

mm | 155 mm W x 37 mm H

CAPACITY:

3 oz.

90 mL

90 cc

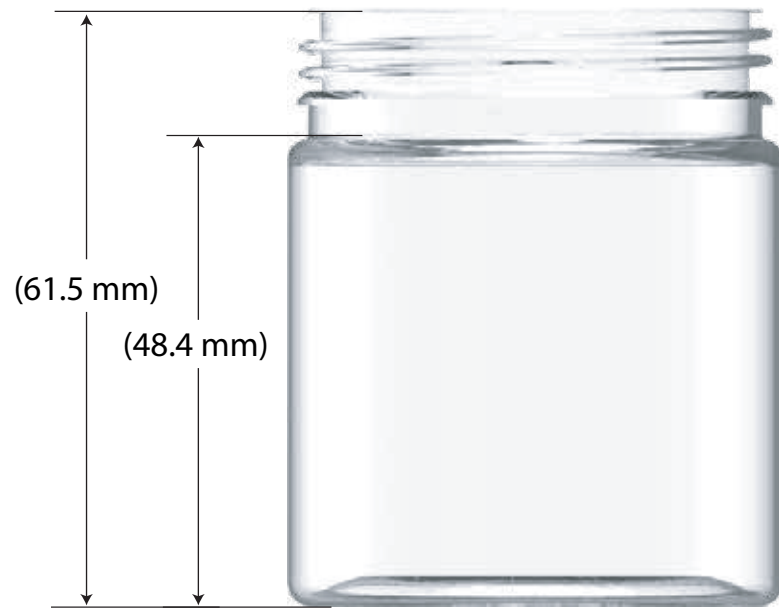
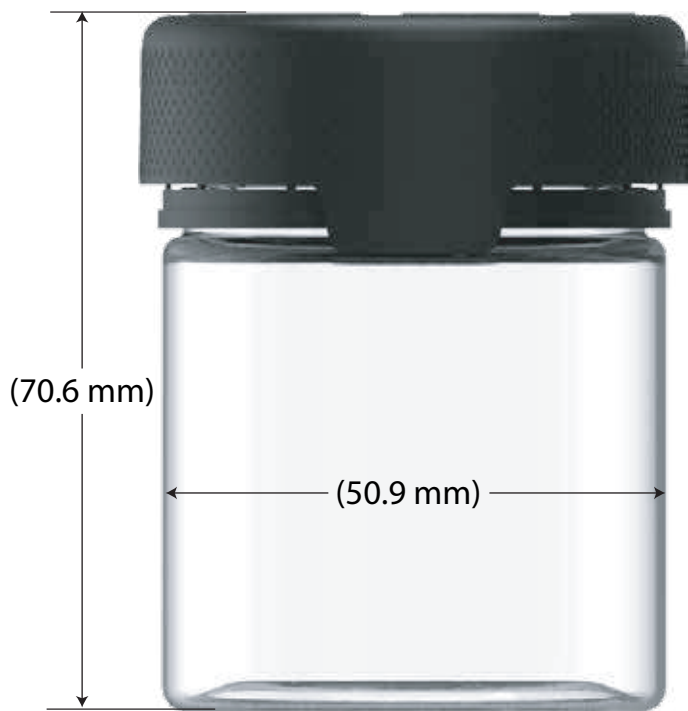
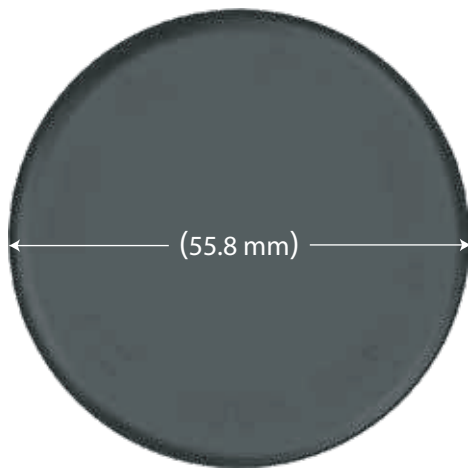

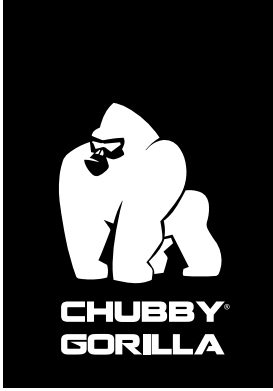

AVIATOR® CONTAINER

SKU: CGAC1-3OZ

LABEL SIZE SUGGESTION: **inch** | 6.1" W x 1.456" H **mm** | 155 mm W x 37 mm H

CAPACITY: 3 oz. 90 mL 90 cc

--- Safe area
— Trim
— Bleed

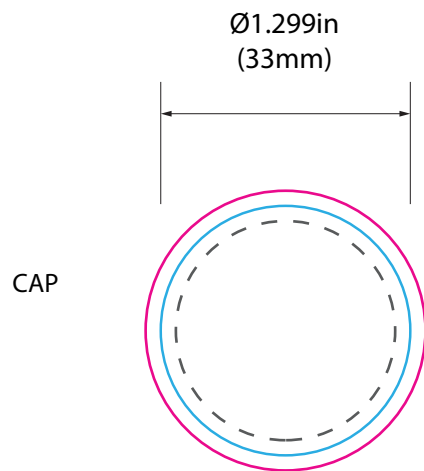
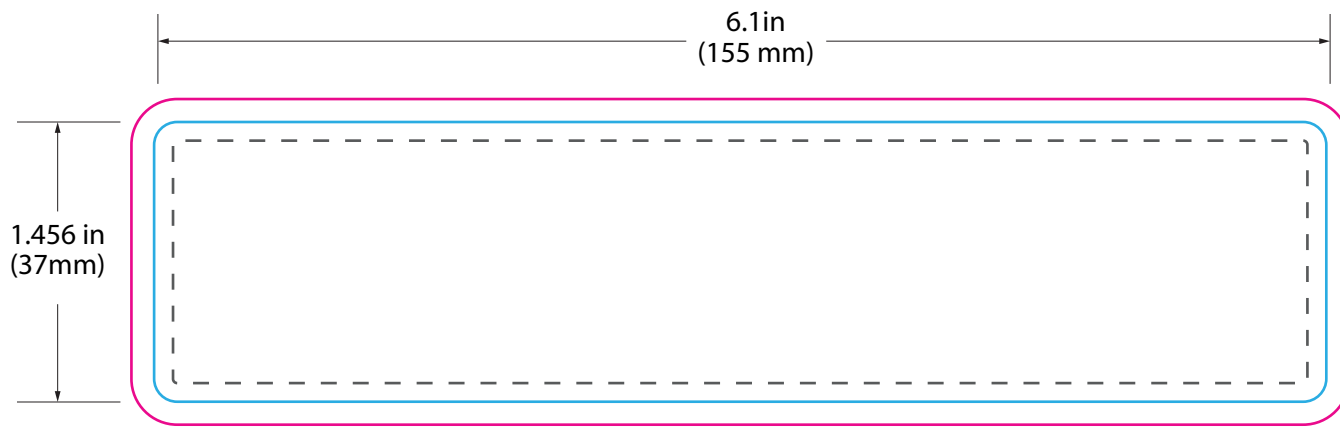

AVIATOR® CONTAINER

CGAC1-3OZ

3 oz.

Please note that the label template may not be to scale. For accurate sizing and verification, refer to the dimension specifications. The provided label guides are for suggestion purposes only, and labels can be adjusted as needed.

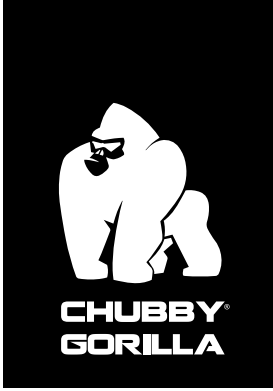

AVIATOR® CONTAINER

SKU: CGAC1-4OZ

LABEL SIZE SUGGESTION:

inch | 6.1" W x 2" H

mm | 155 mm W x 51 mm H

CAPACITY:

4 oz.

120 mL

120 cc

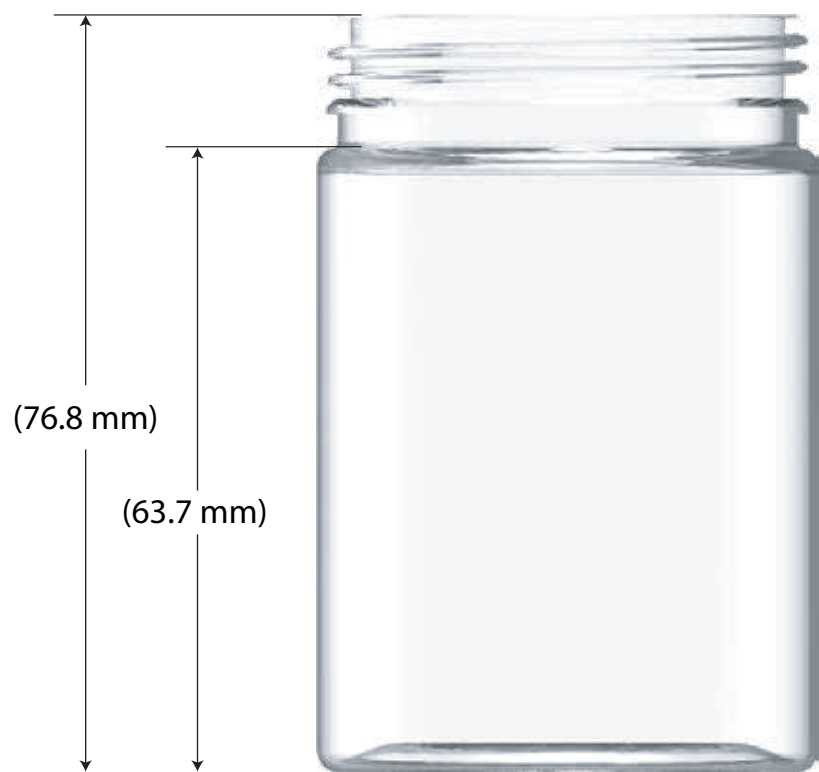

AVIATOR® CONTAINER

CGAC1-4OZ

Label guide →

Please note that the label template may not be to scale. For accurate sizing and verification, refer to the dimension specifications. The provided label guides are for suggestion purposes only, and labels can be adjusted as needed.

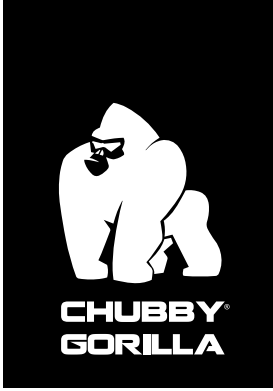

AVIATOR® CONTAINER

SKU: CGAC1-4OZ

LABEL SIZE SUGGESTION:

inch | 6.1" W x 2" H

mm | 155 mm W x 51 mm H

CAPACITY:

4 oz.

120 mL

120 cc

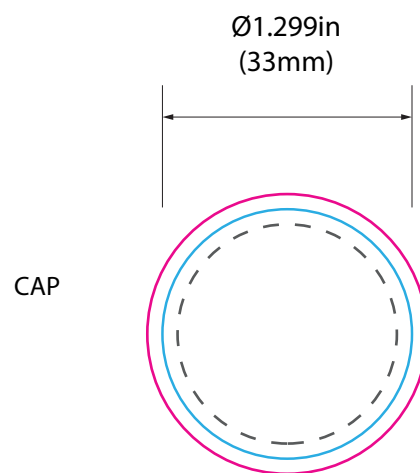
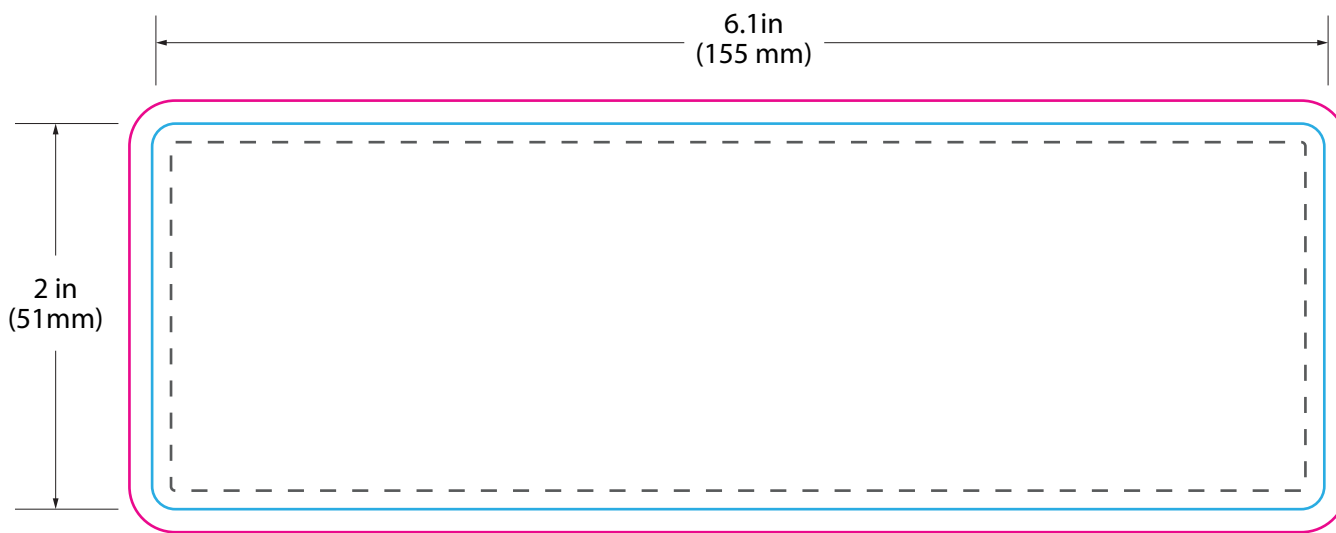
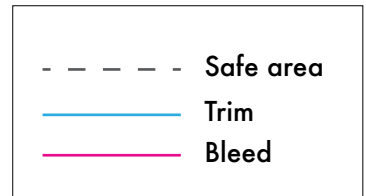

AVIATOR® CONTAINER

CGAC1-4OZ

4 oz.

Please note that the label template may not be to scale. For accurate sizing and verification, refer to the dimension specifications. The provided label guides are for suggestion purposes only, and labels can be adjusted as needed.

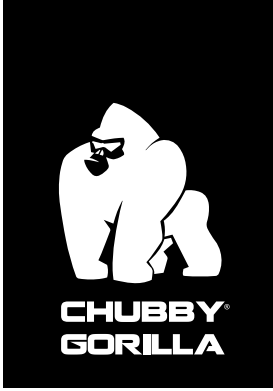

AVIATOR® CONTAINER

SKU: CGAC1-5OZ

LABEL SIZE SUGGESTION:

inch | 6.1" W x 2.59" H

mm | 155 mm W x 66 mm H

CAPACITY:

5 oz.

150 mL

150 cc

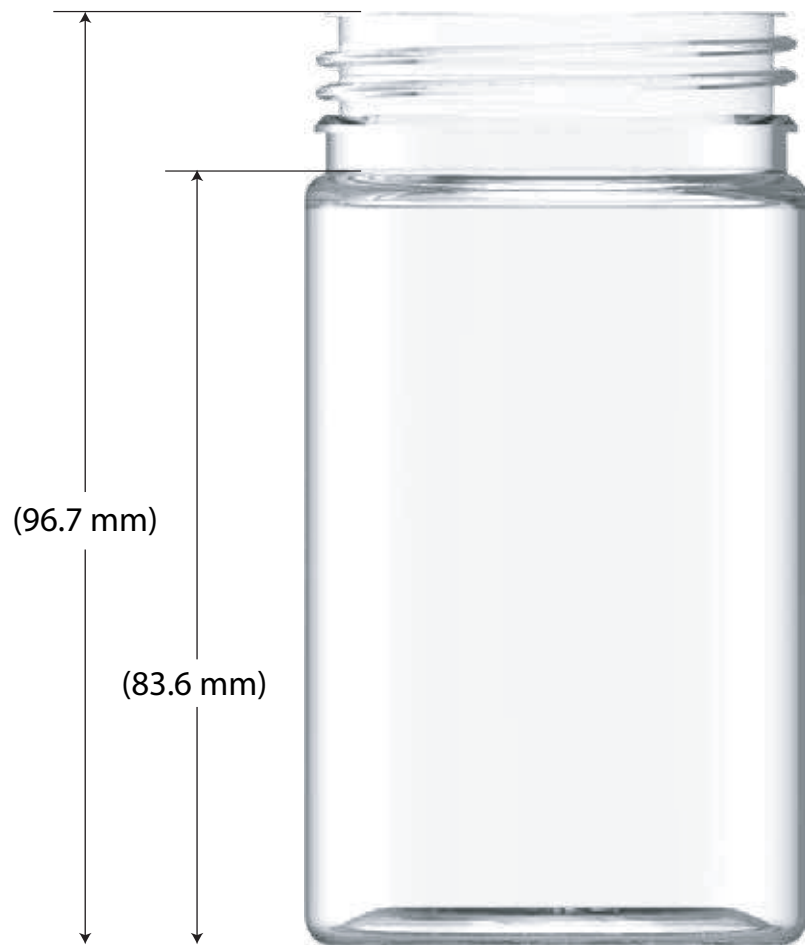
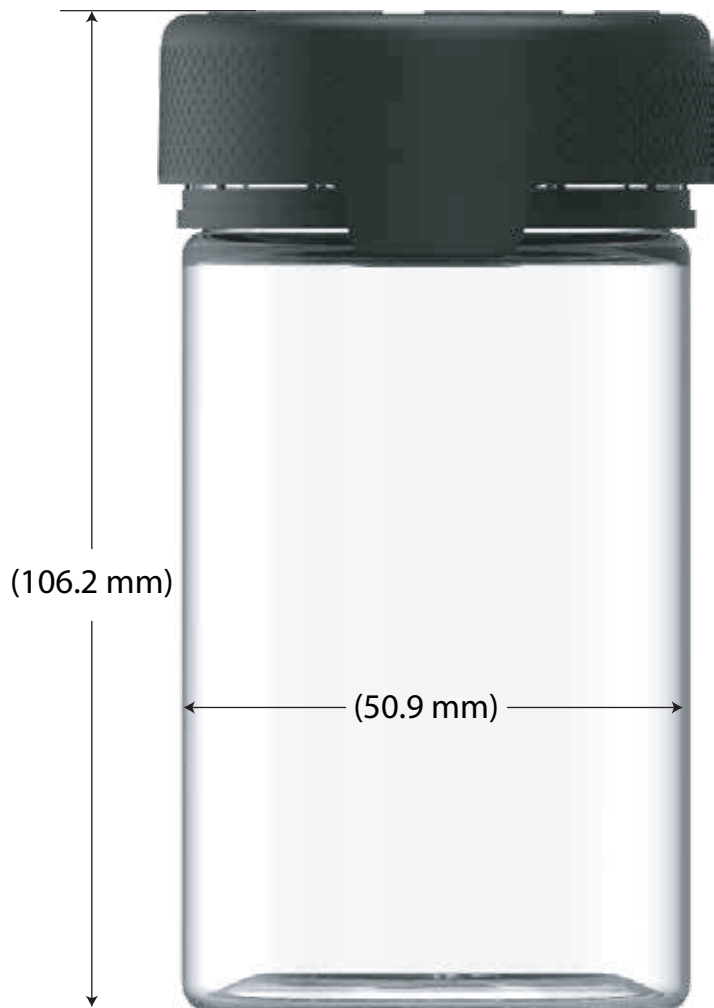
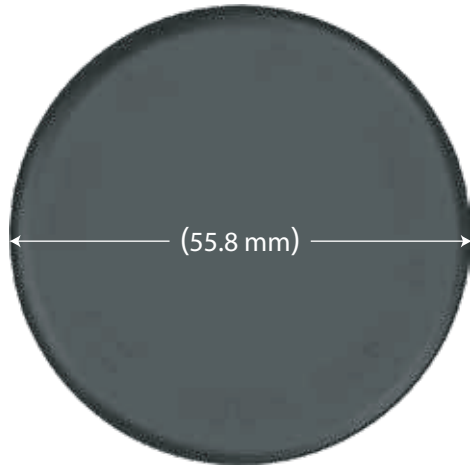

AVIATOR® CONTAINER

CGAC1-5OZ

Label guide →

Please note that the label template may not be to scale. For accurate sizing and verification, refer to the dimension specifications. The provided label guides are for suggestion purposes only, and labels can be adjusted as needed.

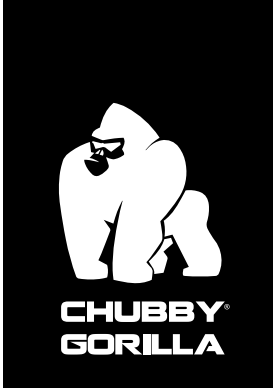

AVIATOR® CONTAINER

SKU: CGAC1-5OZ

LABEL SIZE SUGGESTION: **inch** | 6.1" W x 2.59" H **mm** | 155 mm W x 66 mm H

CAPACITY: 5 oz. 150 mL 150 cc

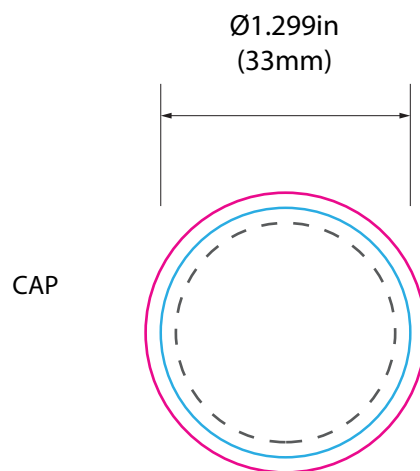
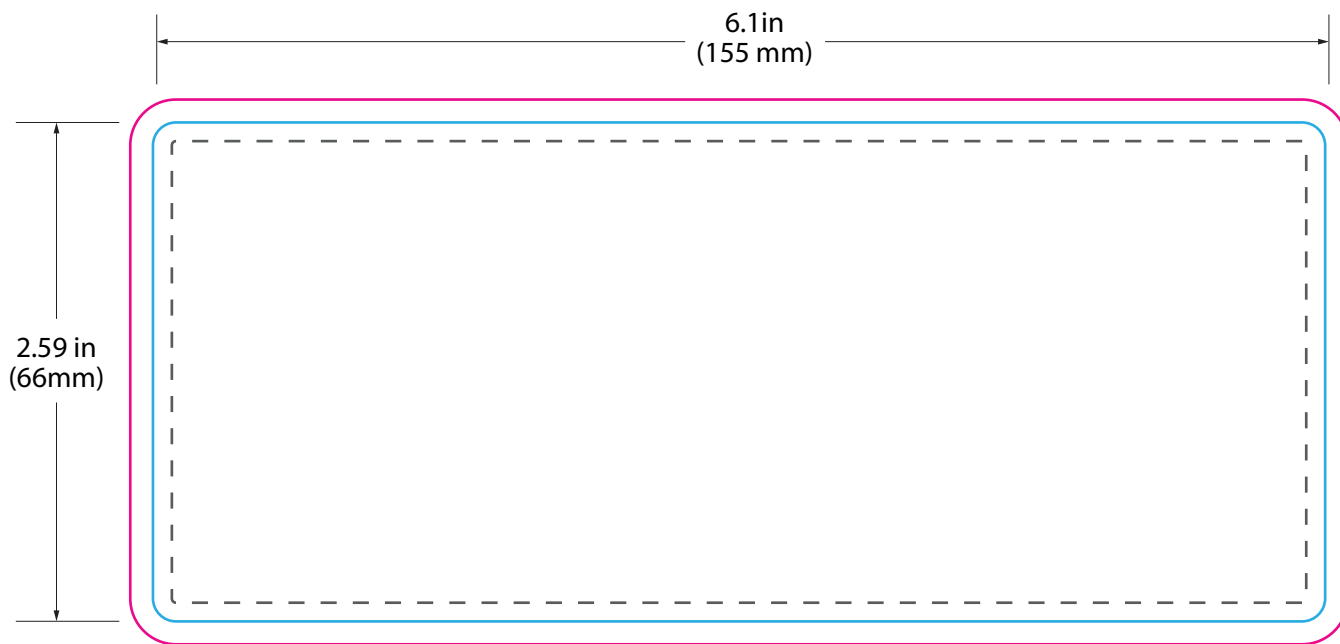
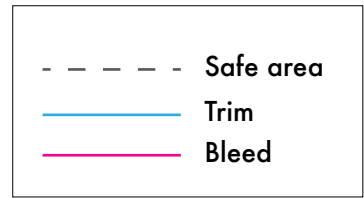

AVIATOR® CONTAINER

CGAC1-5OZ

5 oz.

Please note that the label template may not be to scale. For accurate sizing and verification, refer to the dimension specifications. The provided label guides are for suggestion purposes only, and labels can be adjusted as needed.

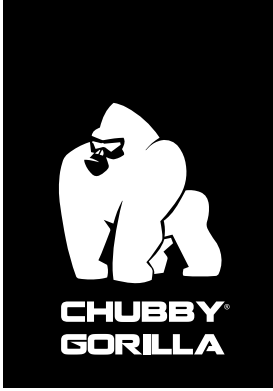

AVIATOR® CONTAINER

SKU: CGAC1-6OZ

LABEL SIZE SUGGESTION:

inch | 6.1" W x 3.385" H

mm | 155 mm W x 86 mm H

CAPACITY:

6 oz.

180 mL

180 cc

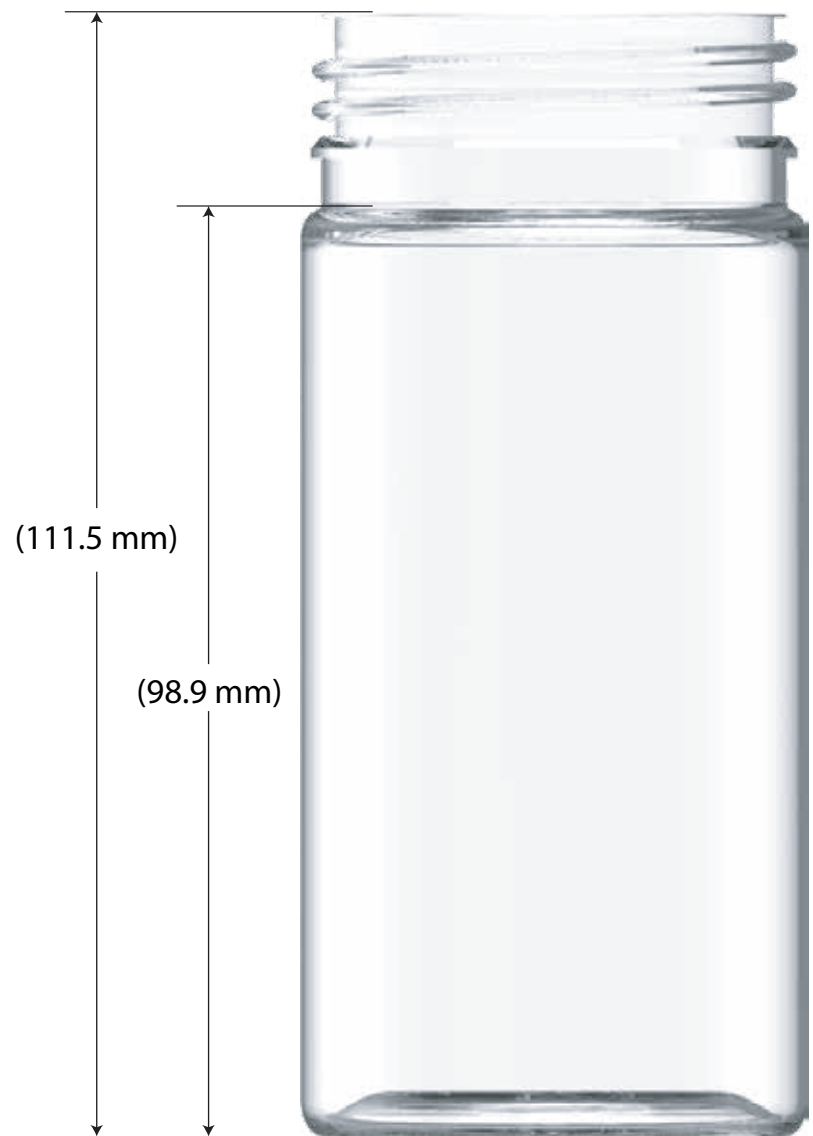
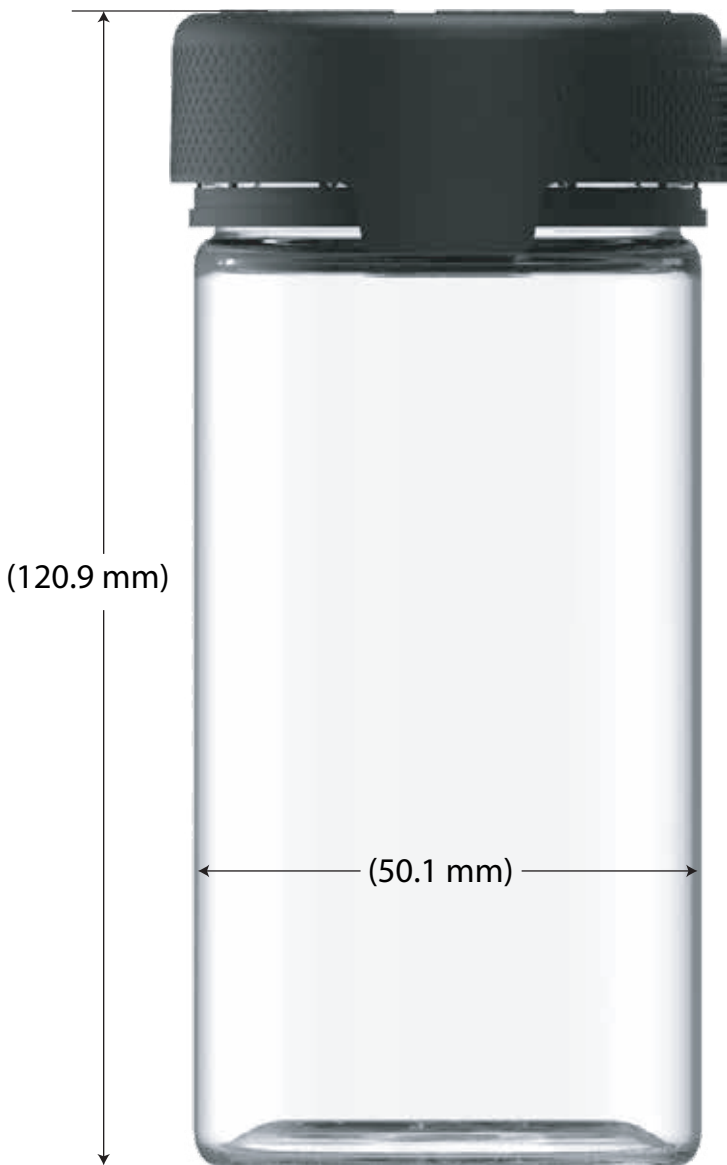

AVIATOR® CONTAINER

CGAC1-6OZ

Label guide →

Please note that the label template may not be to scale. For accurate sizing and verification, refer to the dimension specifications. The provided label guides are for suggestion purposes only, and labels can be adjusted as needed.

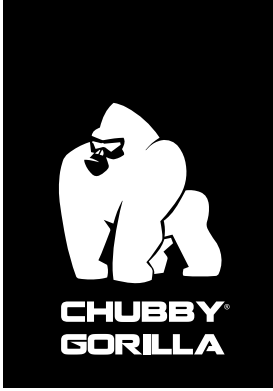

AVIATOR® CONTAINER

SKU: CGAC1-6OZ

LABEL SIZE SUGGESTION: **inch** | 6.1" W x 3.385" H **mm** | 155 mm W x 86 mm H

CAPACITY: 6 oz. 180 mL 180 cc

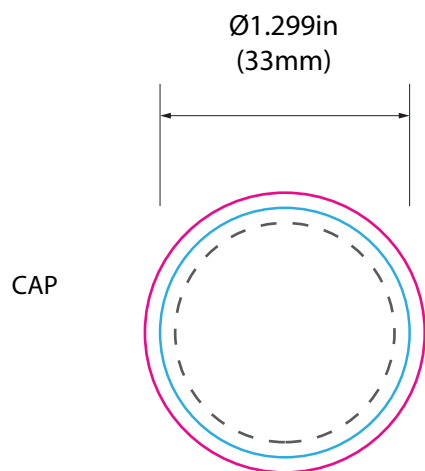
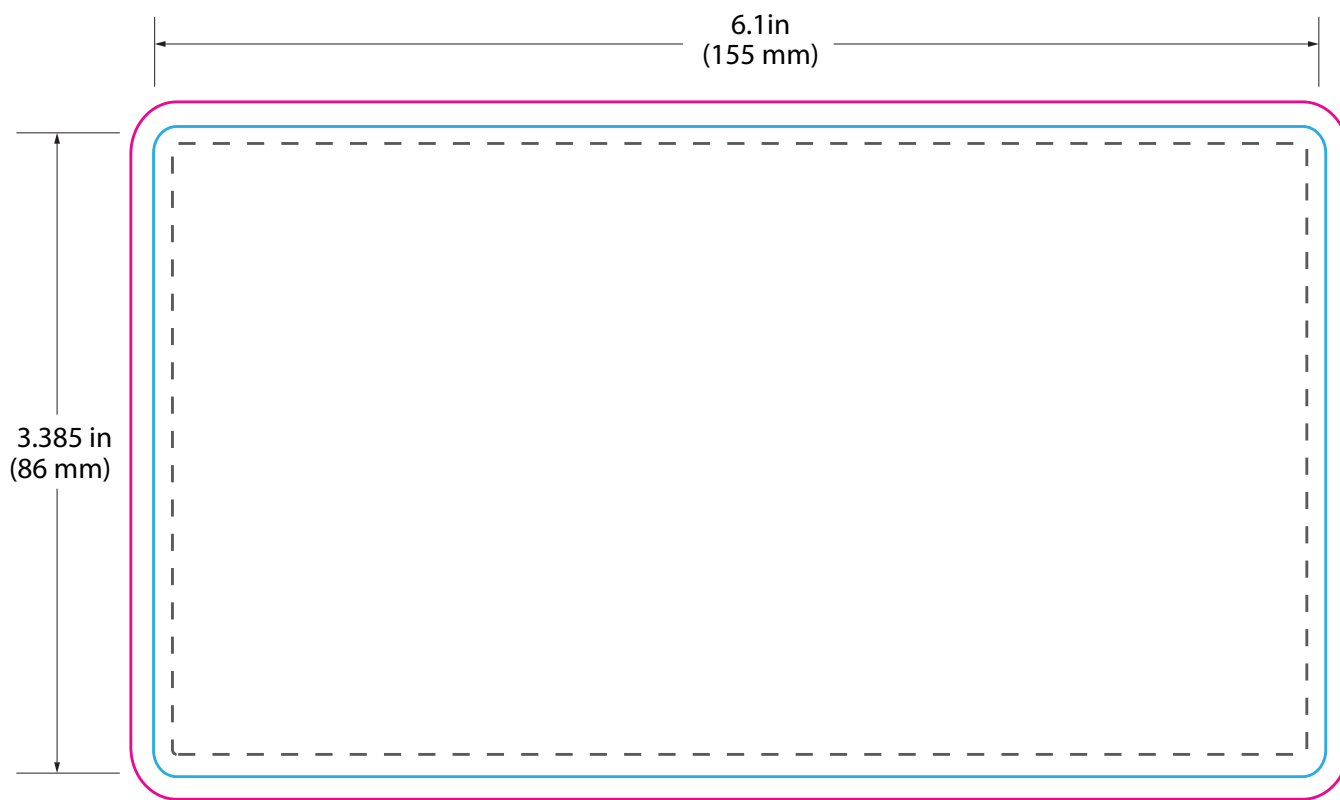
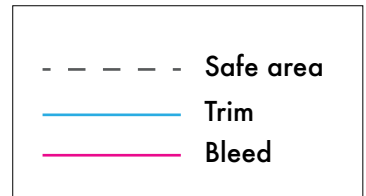

AVIATOR® CONTAINER

CGAC1-6OZ

6 oz.

Please note that the label template may not be to scale. For accurate sizing and verification, refer to the dimension specifications. The provided label guides are for suggestion purposes only, and labels can be adjusted as needed.

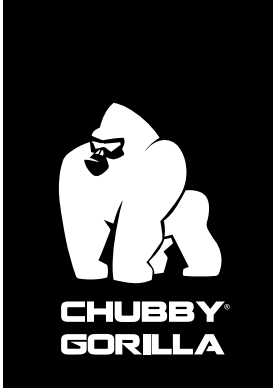

AVIATOR® CONTAINER

SKU: CGAC1-8OZ

LABEL SIZE SUGGESTION:

inch | 6.18" W x 4.33" H

mm | 157 mm W x 110 mm H

CAPACITY:

8 oz.

240 mL

240 cc

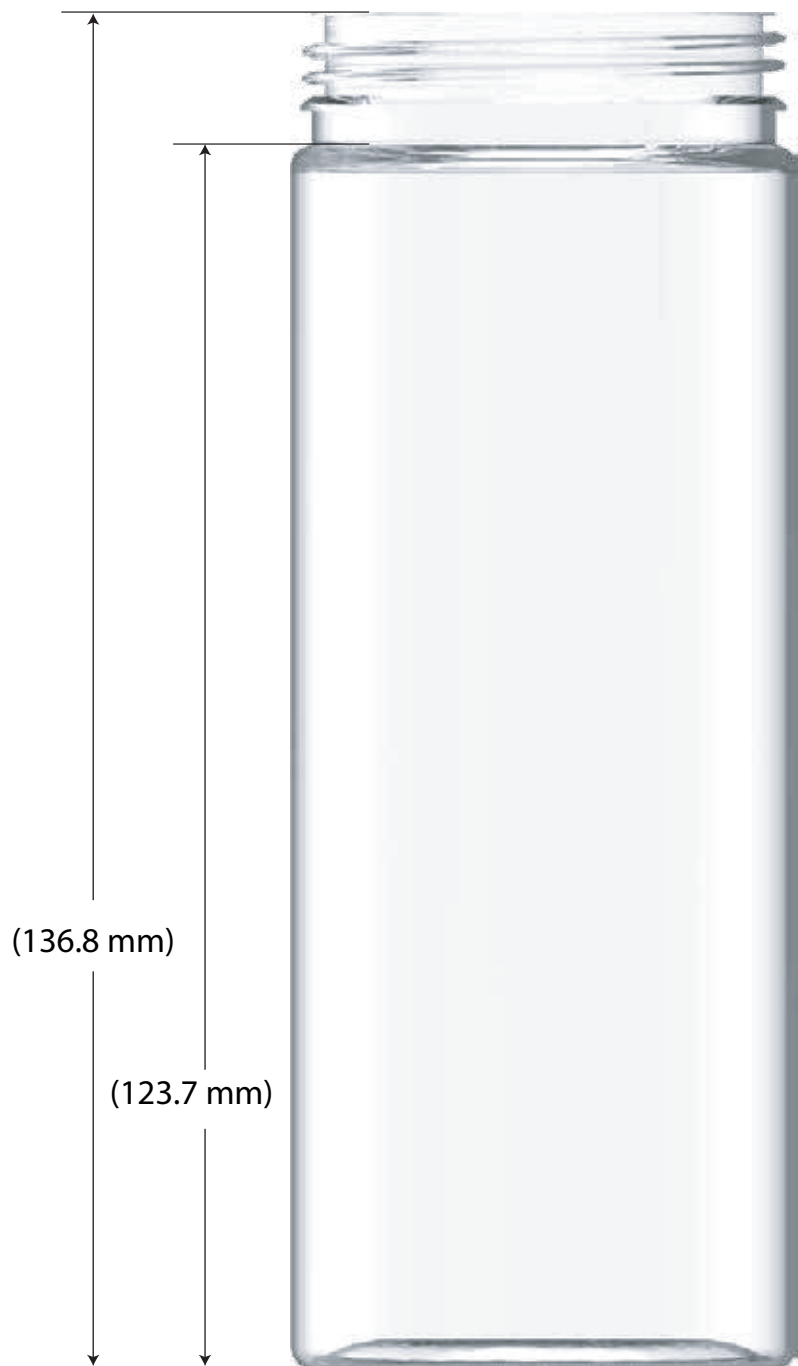
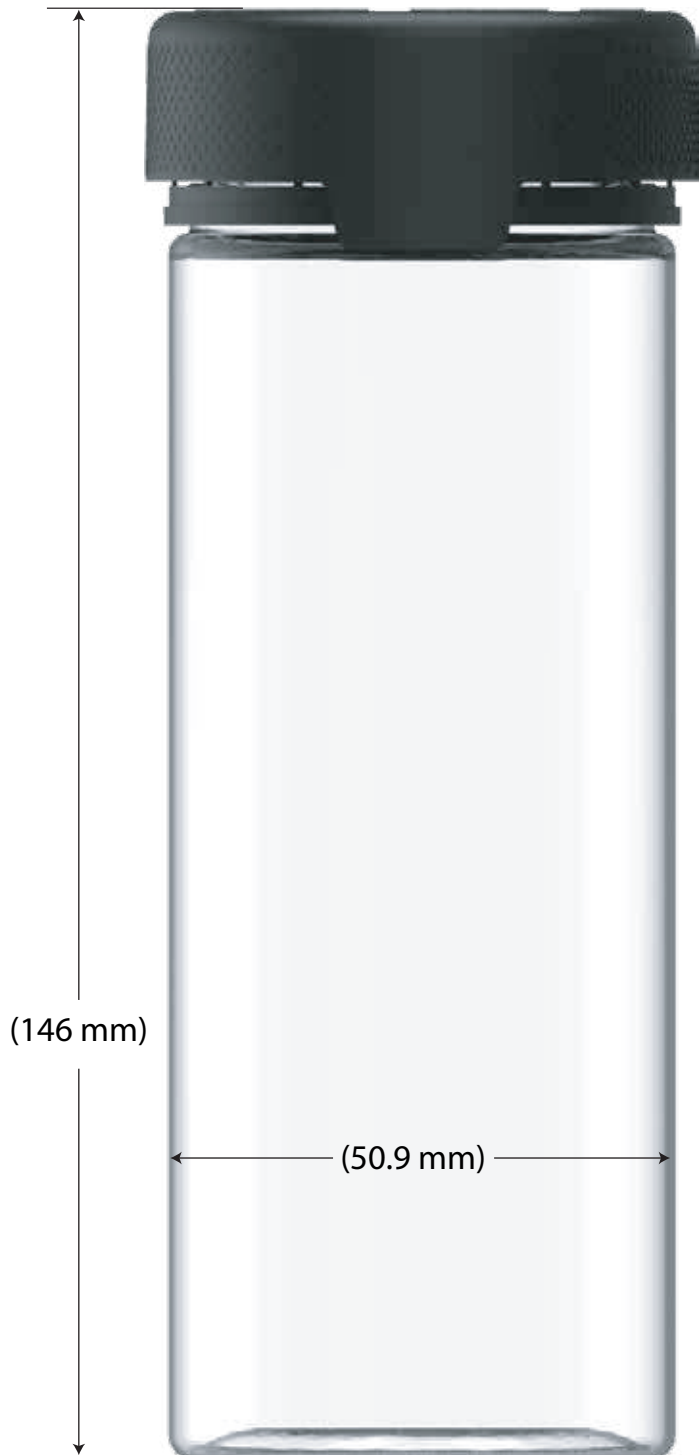

AVIATOR® CONTAINER

CGAC1-8OZ

Label guide →

Please note that the label template may not be to scale. For accurate sizing and verification, refer to the dimension specifications. The provided label guides are for suggestion purposes only, and labels can be adjusted as needed.

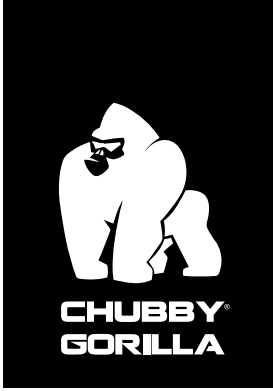

AVIATOR® CONTAINER

SKU: CGAC1-8OZ

LABEL SIZE SUGGESTION: **inch** | 6.18" W x 4.33" H **mm** | 157 mm W x 110 mm H

CAPACITY: 8 oz. 240 mL 240 cc

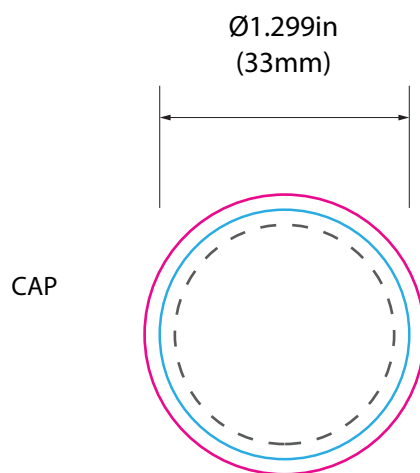
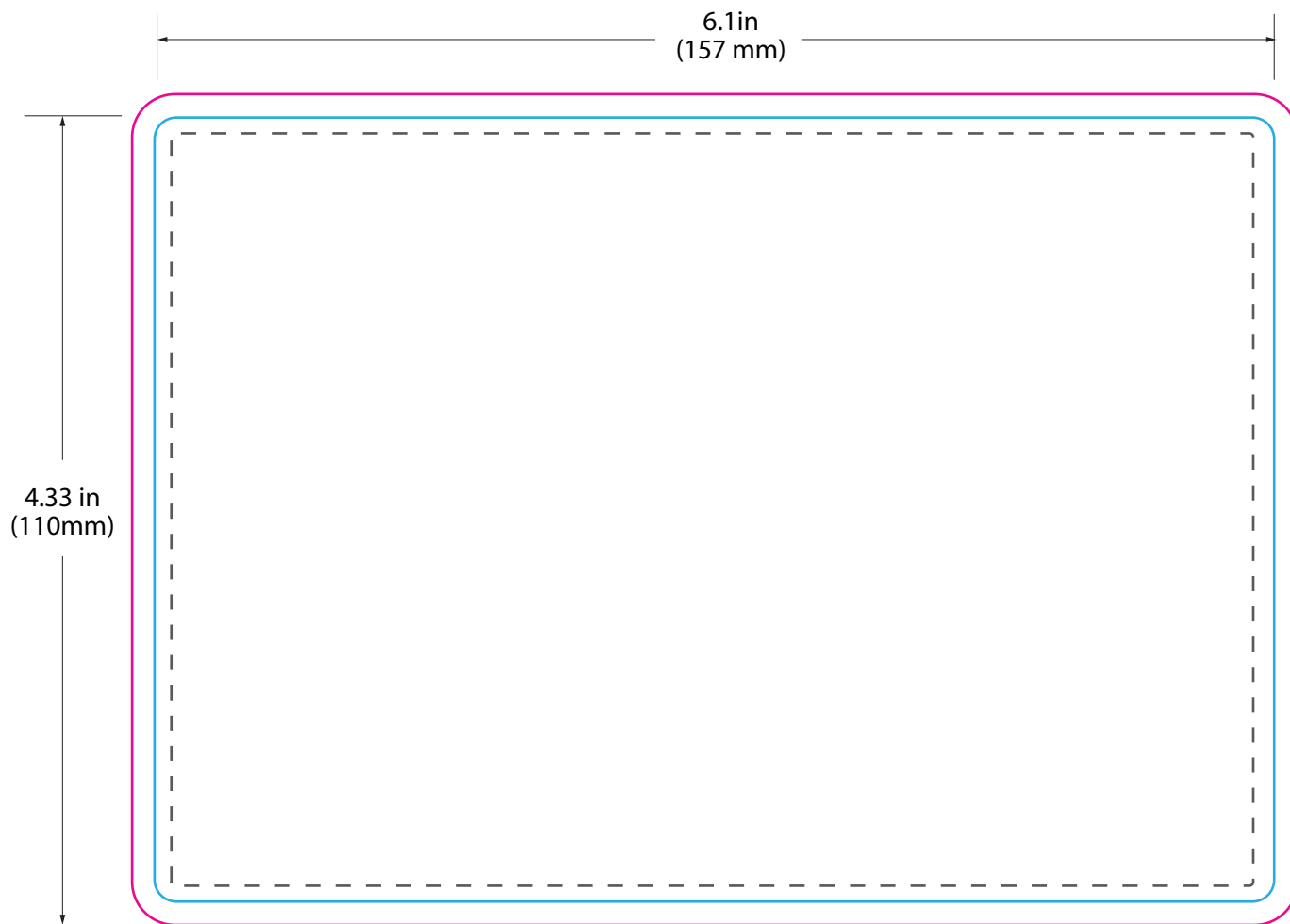
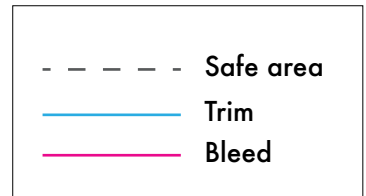

AVIATOR® CONTAINER

CGAC1-8OZ

8 oz.

Please note that the label template may not be to scale. For accurate sizing and verification, refer to the dimension specifications. The provided label guides are for suggestion purposes only, and labels can be adjusted as needed.

AVIATOR® XL CONTAINERS

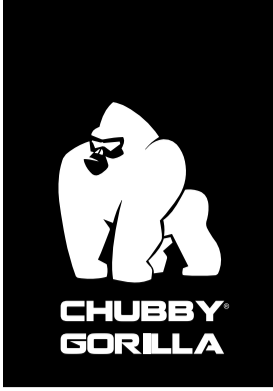

AVIATOR® XL CONTAINER

SKU: CGAC1-7.5OZXL

LABEL SIZE SUGGESTION:

inch | 10.629" W x 1.102" H

mm | 270 mm W x 28 mm H

CAPACITY:

7.5 oz.

220 mL

220 cc



AVIATOR® XL CONTAINER

CGAC1-7.5OZXL

Label guide →

Please note that the label template may not be to scale. For accurate sizing and verification, refer to the dimension specifications. The provided label guides are for suggestion purposes only, and labels can be adjusted as needed.

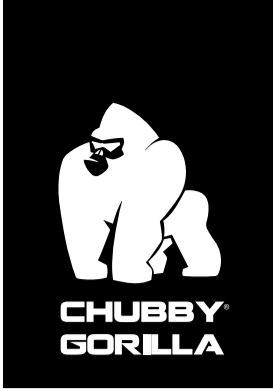

AVIATOR® XL CONTAINER

SKU: CGAC1-7.5OZXL

LABEL SIZE SUGGESTION:

inch | 11.023" W x 1.102" H

mm | 280 mm W x 28 mm H

CAPACITY:

7.5 oz.

220 mL

220 cc

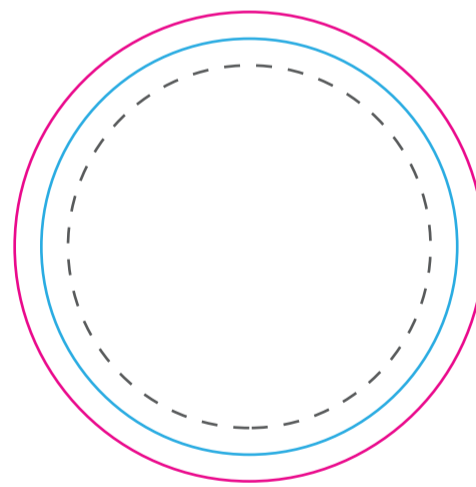
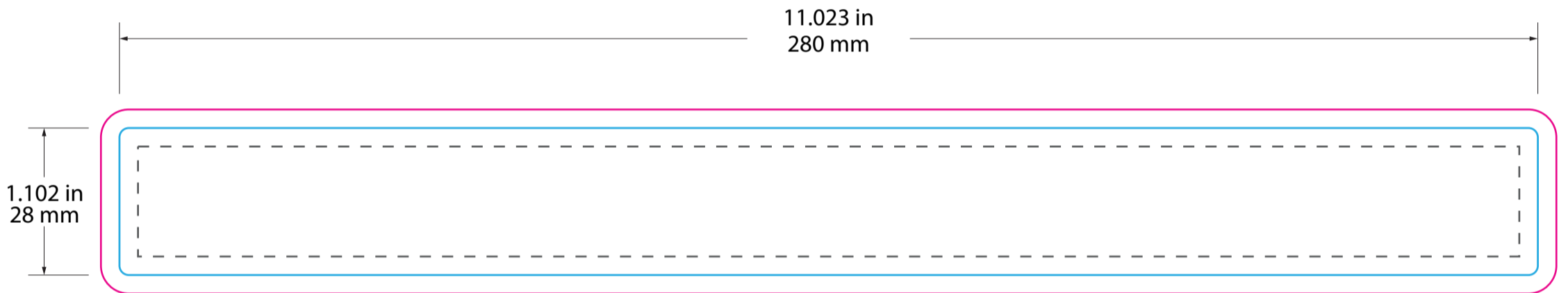
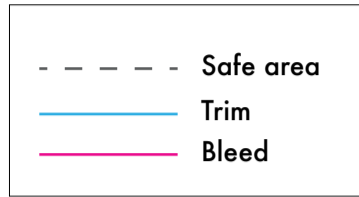

Ø2.16 in
(55 mm)



AVIATOR® XL CONTAINER

CGAC1-7.5OZXL

7.5 oz.

Please note that the label template may not be to scale. For accurate sizing and verification, refer to the dimension specifications. The provided label guides are for suggestion purposes only, and labels can be adjusted as needed.

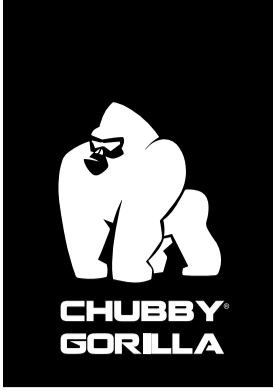

AVIATOR® XL CONTAINER

SKU: CGAC1-10OZXL

LABEL SIZE SUGGESTION:

inch | 10.629" W x 1.437" H

mm | 270 mm W x 36.5 mm H

CAPACITY:

10 oz.

300 mL

300 cc

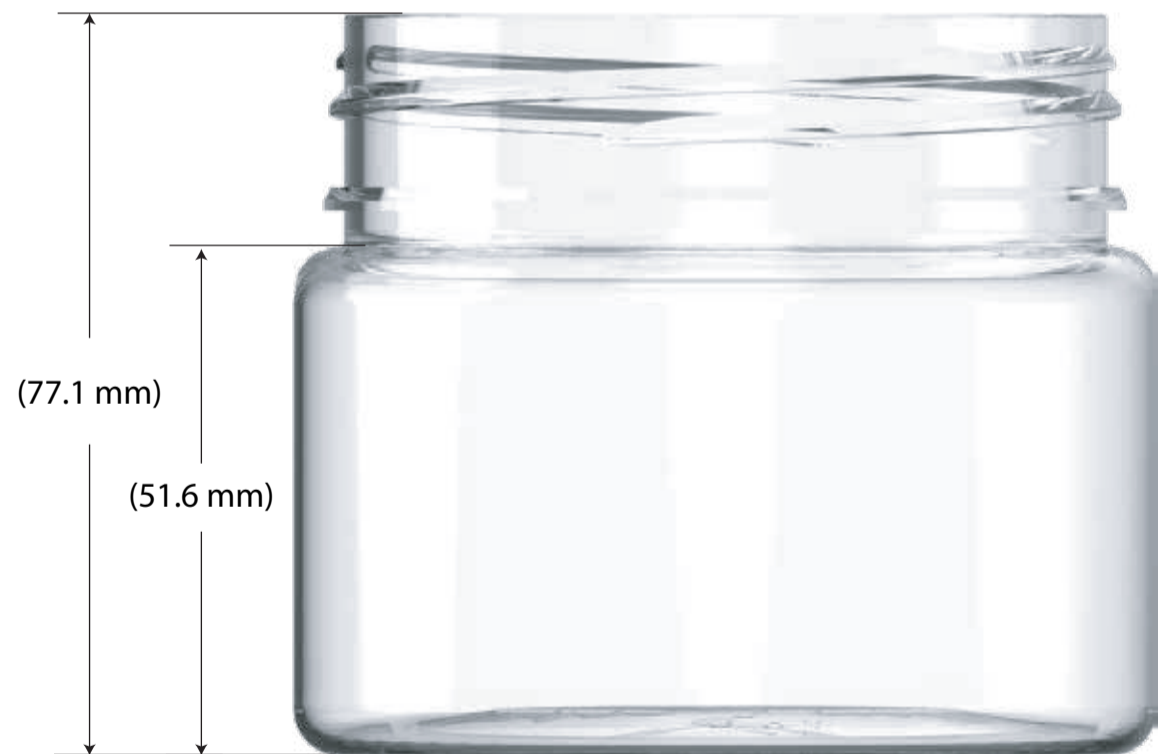
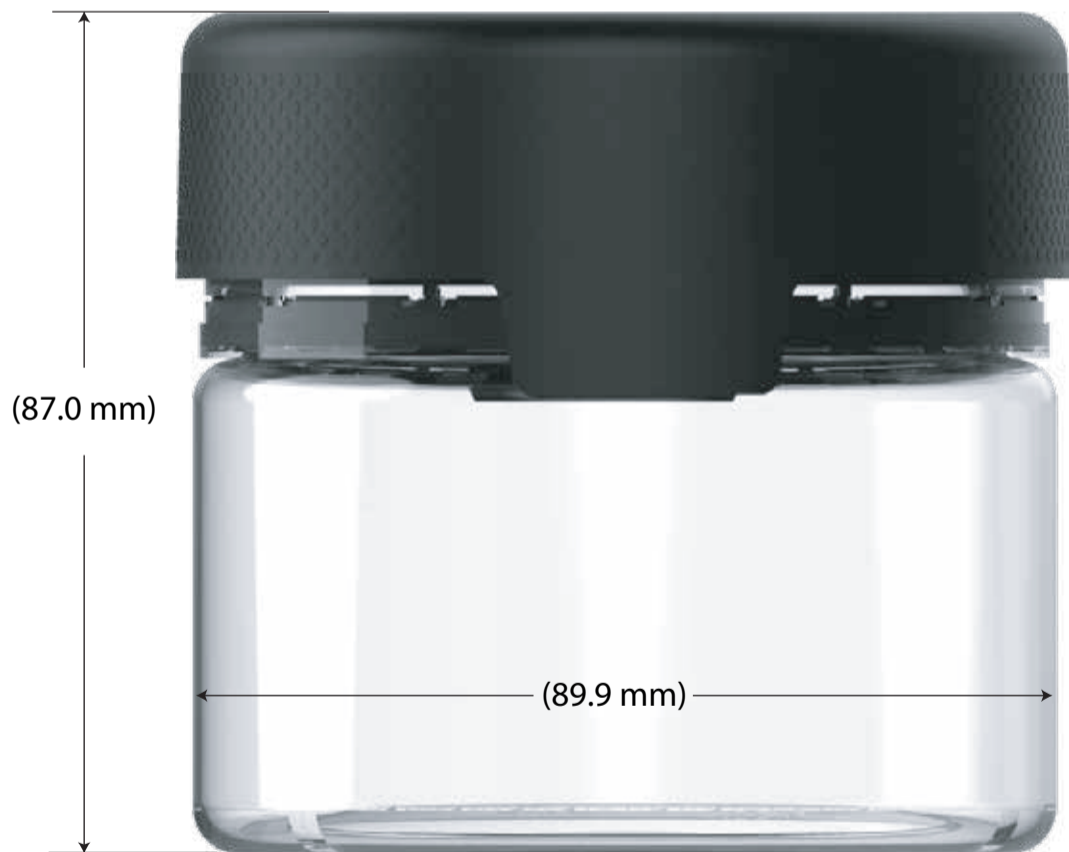

AVIATOR® XL CONTAINER

CGAC1-10OZXL

Label guide →

Please note that the label template may not be to scale. For accurate sizing and verification, refer to the dimension specifications. The provided label guides are for suggestion purposes only, and labels can be adjusted as needed.



AVIATOR® XL CONTAINER

SKU: CGAC1-10OZXL

LABEL SIZE SUGGESTION:

inch | 11.023" W x 1.437" H

mm | 280 mm W x 36.5 mm H

CAPACITY:

10 oz.

220 mL

220 cc

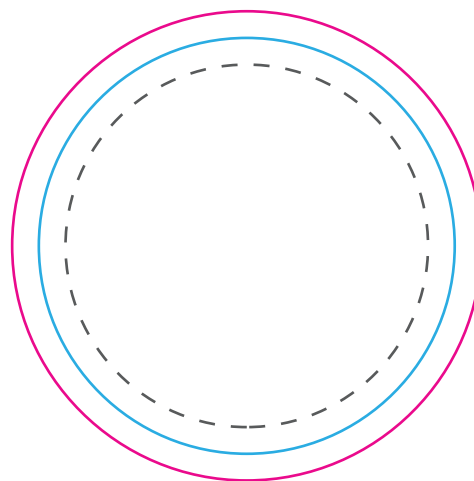
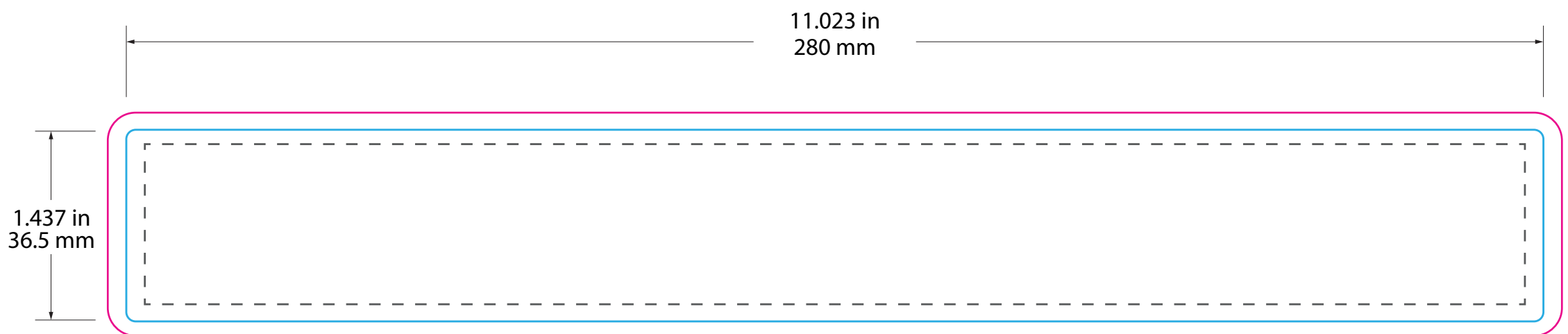
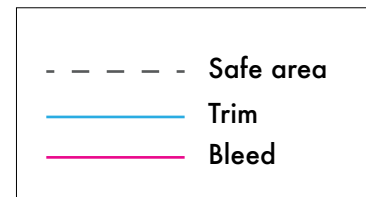

Ø2.16 in
(55 mm)



AVIATOR® XL CONTAINER

CGAC1-10OZXL

10 oz.

Please note that the label template may not be to scale. For accurate sizing and verification, refer to the dimension specifications. The provided label guides are for suggestion purposes only, and labels can be adjusted as needed.

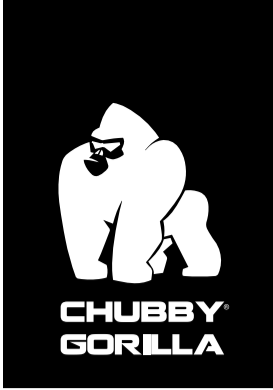

AVIATOR® XL CONTAINER

SKU: CGAC1-18.5OZXL

LABEL SIZE SUGGESTION:

inch | 11.338" W x 2.95" H

mm | 288 mm W x 75 mm H

CAPACITY:

18.5 oz.

550 mL

550 cc

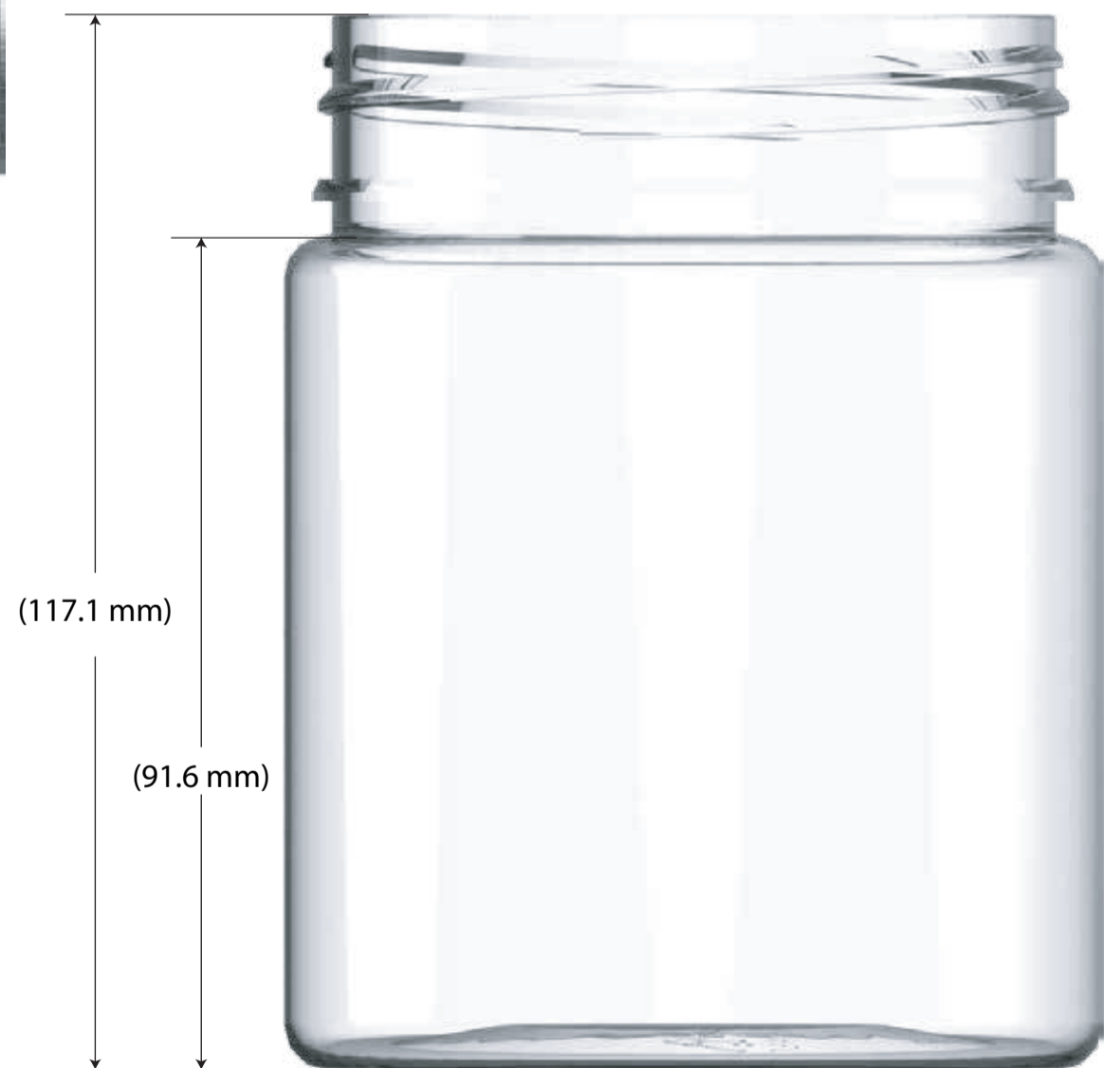

AVIATOR® XL CONTAINER

CGAC1-18.5OZXL

Label guide →

Please note that the label template may not be to scale. For accurate sizing and verification, refer to the dimension specifications. The provided label guides are for suggestion purposes only, and labels can be adjusted as needed.

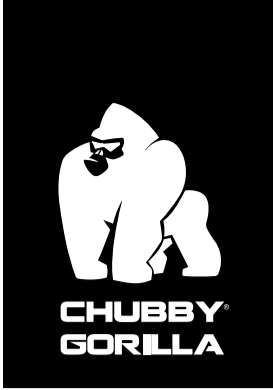

AVIATOR® CONTAINER

SKU: CGAC1-18.5OZXL

LABEL SIZE SUGGESTION:

inch | 11.023" W x 2.95" H

mm | 280 mm W x 75 mm H

CAPACITY:

18.5 oz.

550 mL

550 cc

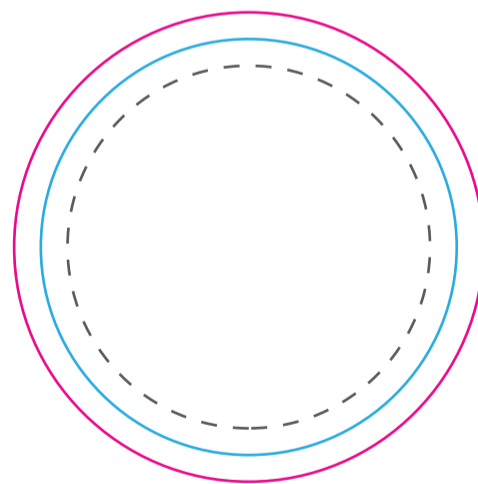
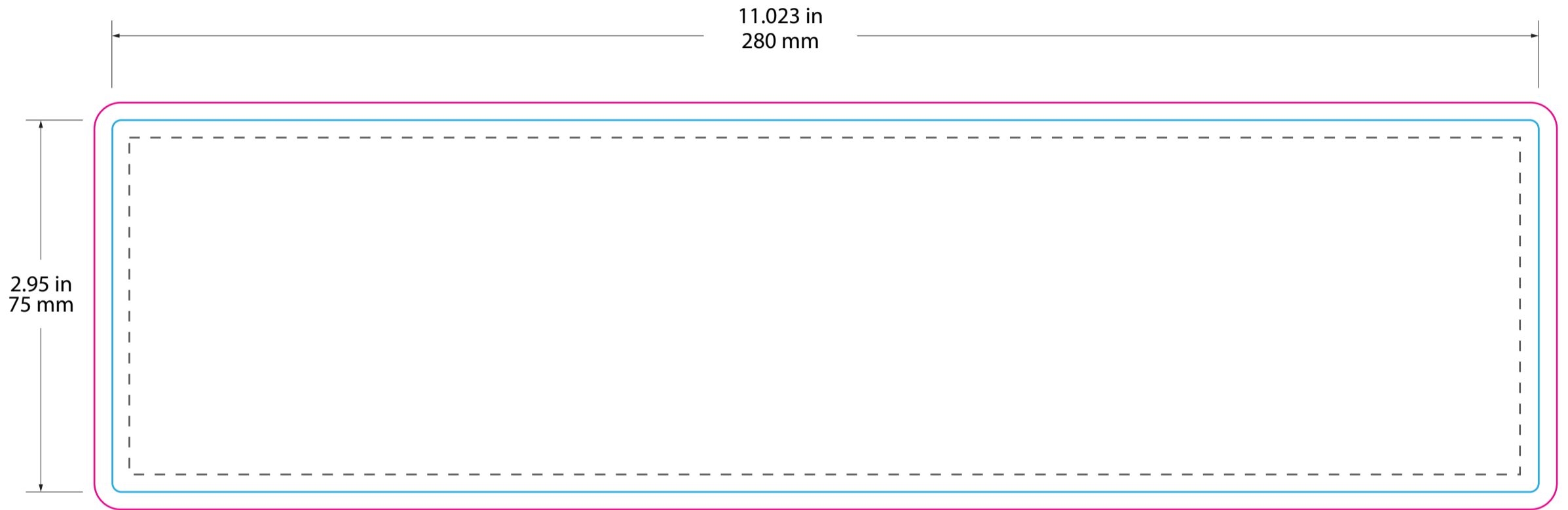

Ø2.16 in
(55 mm)



AVIATOR® XL CONTAINER

CGAC1-18.5OZXL

18.5 oz.

Please note that the label template may not be to scale. For accurate sizing and verification, refer to the dimension specifications. The provided label guides are for suggestion purposes only, and labels can be adjusted as needed.



AVIATOR® XL CONTAINER

SKU: CGAC1-21.5OZXL

LABEL SIZE SUGGESTION:

inch | 11.378" W x 3.346" H

mm | 288 mm W x 85 mm H

CAPACITY:

21.5 oz.

625 mL

625 cc

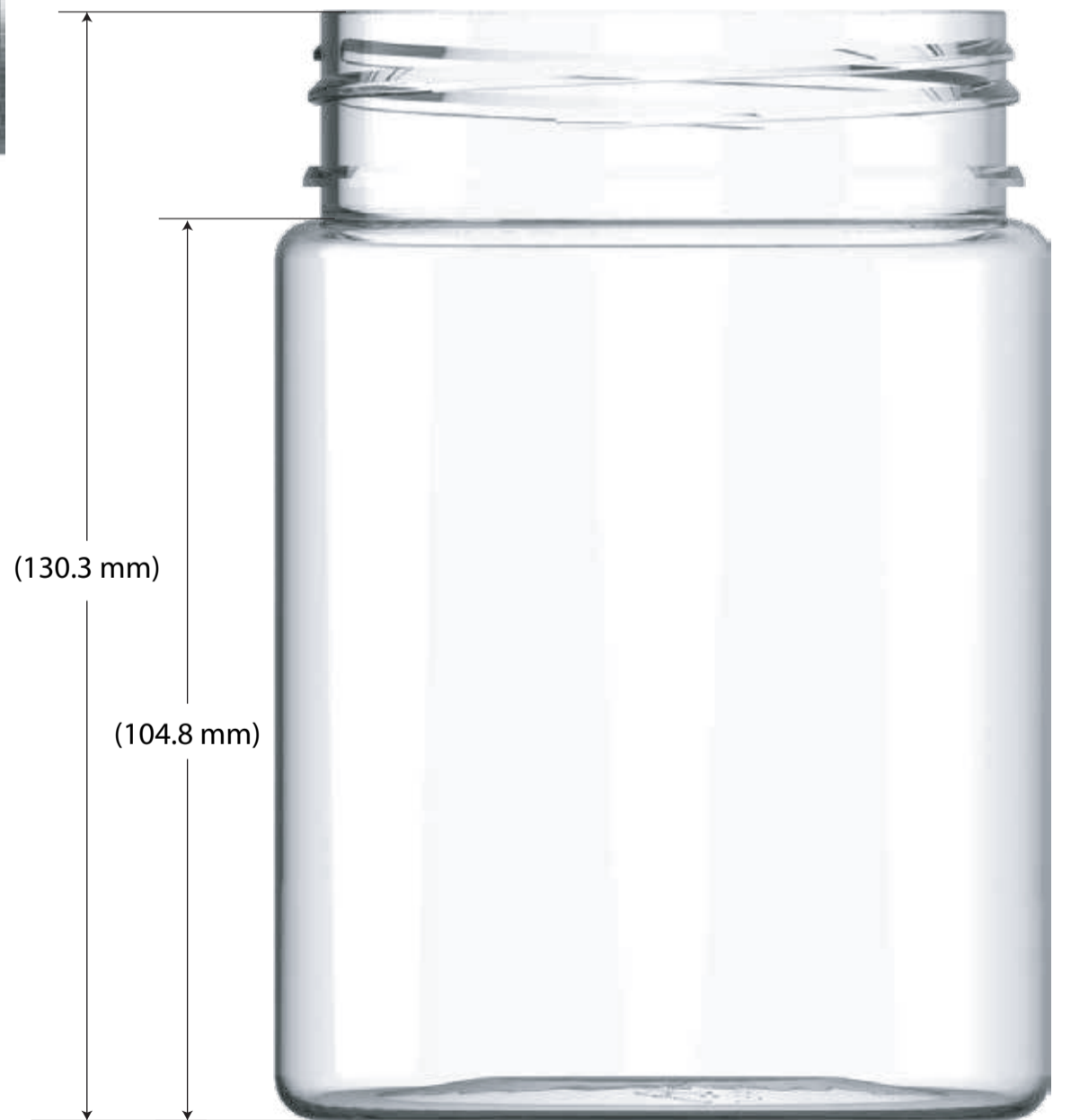

AVIATOR® XL CONTAINER

CGAC1-21.5OZXL

Label guide →

Please note that the label template may not be to scale. For accurate sizing and verification, refer to the dimension specifications. The provided label guides are for suggestion purposes only, and labels can be adjusted as needed.

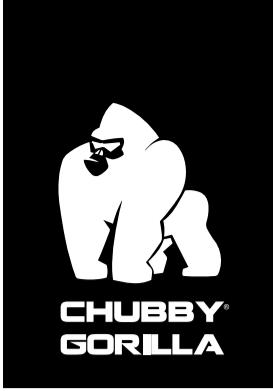

AVIATOR® XL CONTAINER

SKU: CGAC1-21.5OZXL

LABEL SIZE SUGGESTION:

inch | 11.023" W x 3.346" H

mm | 280 mm W x 85 mm H

CAPACITY:

21.5 oz.

625 mL

625 cc

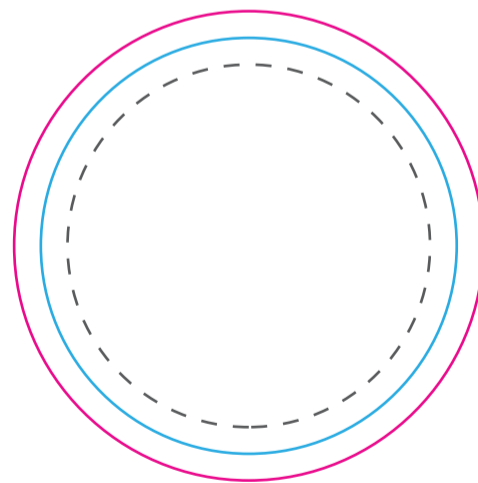
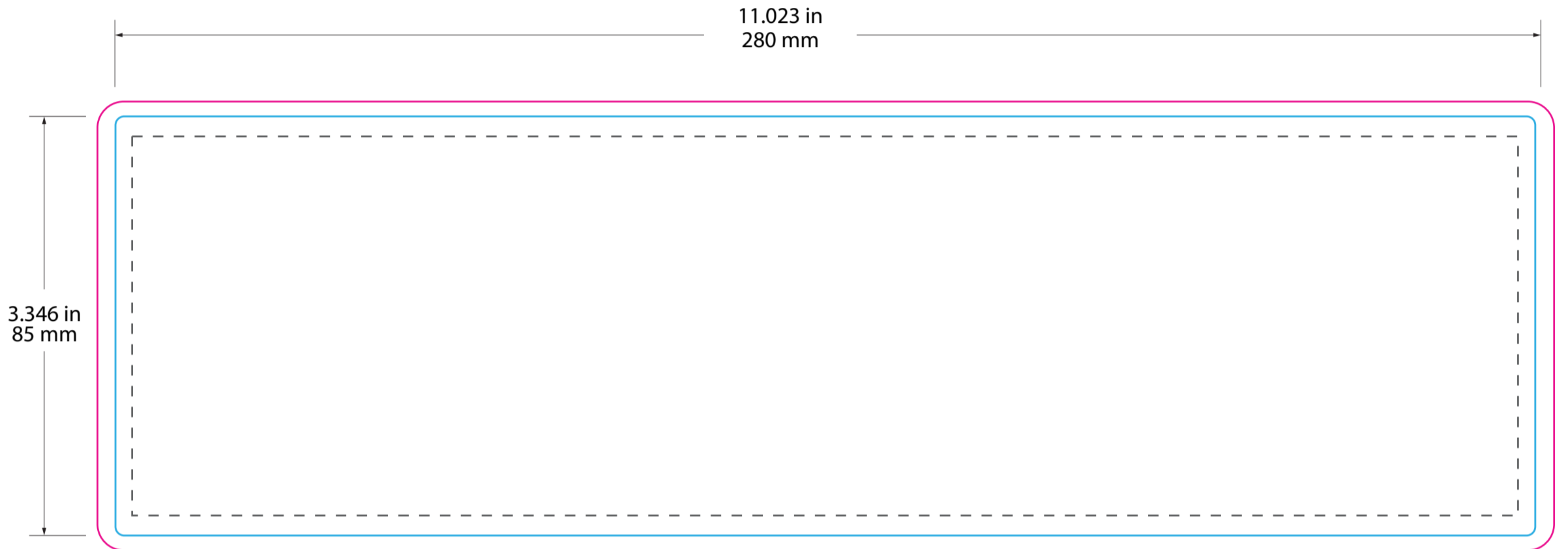
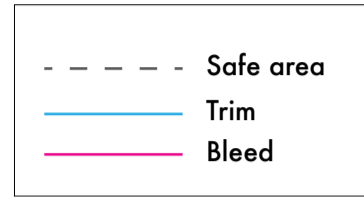

Ø2.16 in
(55 mm)



AVIATOR® XL CONTAINER

CGAC1-21.5OZXL

21.5 oz.

Please note that the label template may not be to scale. For accurate sizing and verification, refer to the dimension specifications. The provided label guides are for suggestion purposes only, and labels can be adjusted as needed.

AVIATOR® BOTTLES

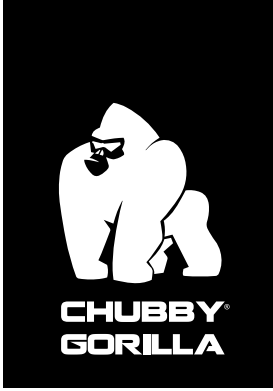

AVIATOR® BOTTLE

SKU: CGAB1-10ML

LABEL SIZE SUGGESTION:

inch | 2.6" W x 1.12" H

mm | 66.04 mm W x 28.47 mm H

CAPACITY:

10 mL

0.34 oz.

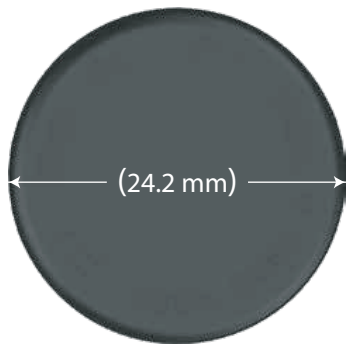

AVIATOR® BOTTLE

CGAB1-10ML

Label guide →

Please note that the label template may not be to scale. For accurate sizing and verification, refer to the dimension specifications. The provided label guides are for suggestion purposes only, and labels can be adjusted as needed.

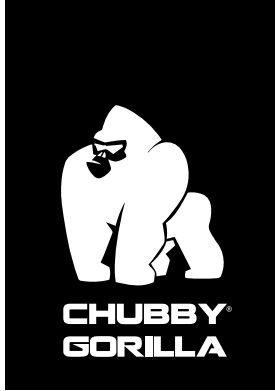

AVIATOR® BOTTLE

SKU: CGAB1-10ML

LABEL SIZE SUGGESTION: **inch** | 2.6" W x 1.12" H **mm** | 66.04 mm W x 28.57 mm H

CAPACITY: 10 mL 0.34 oz.

--- Safe area
— Trim
— Bleed

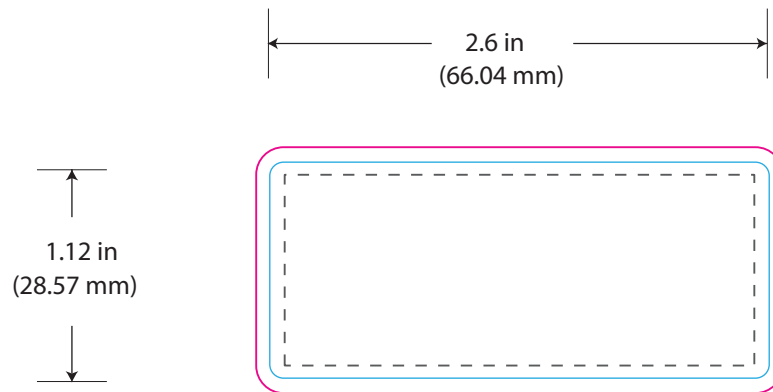

AVIATOR® BOTTLE

CGAB1-10ML

10 mL

Please note that the label template may not be to scale. For accurate sizing and verification, refer to the dimension specifications. The provided label guides are for suggestion purposes only, and labels can be adjusted as needed.

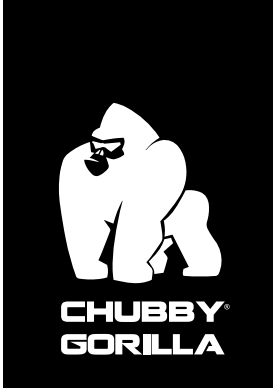

AVIATOR® BOTTLE

SKU: CGAB1-16.5ML

LABEL SIZE SUGGESTION:

inch | 2.59" W x 1.8" H

mm | 66 mm W x 45.72 mm H

CAPACITY:

16.5 mL

0.56 oz.

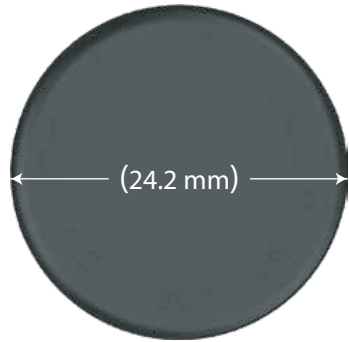

AVIATOR® BOTTLE

CGAB1-16.5ML

Label guide →

Please note that the label template may not be to scale. For accurate sizing and verification, refer to the dimension specifications. The provided label guides are for suggestion purposes only, and labels can be adjusted as needed.

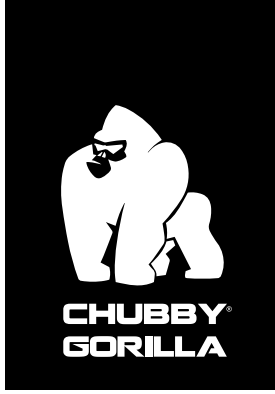

AVIATOR® BOTTLE

SKU: CGAB1-16.5ML

LABEL SIZE SUGGESTION: **inch** | 2.59" W x 1.8" H **mm** | 66 mm W x 45.72 mm H

CAPACITY: 16.5 mL 0.56 oz.

--- Safe area
— Trim
— Bleed

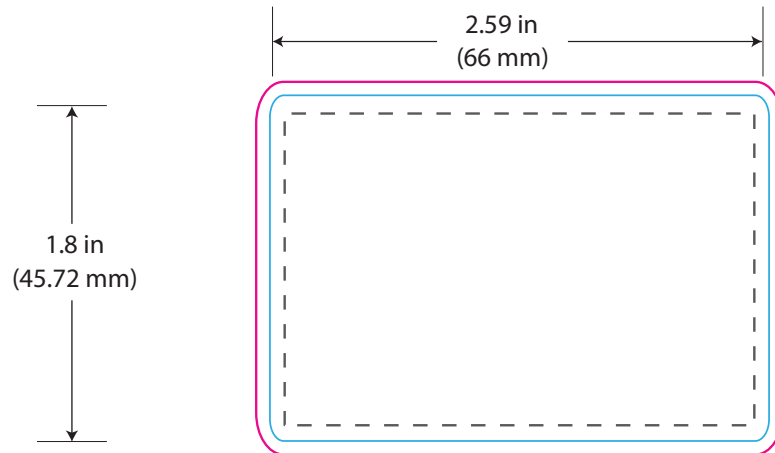

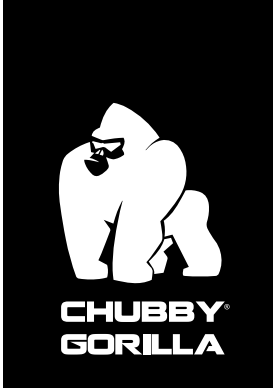

AVIATOR® BOTTLE

SKU: CGAB1-20ML

LABEL SIZE SUGGESTION:

inch | 2.59" W x 2.1" H

mm | 66 mm W x 53.34 mm H

CAPACITY:

20 mL

0.68 oz.

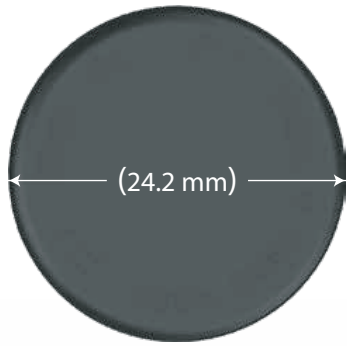

AVIATOR® BOTTLE

CGAB1-20ML

Label guide →

Please note that the label template may not be to scale. For accurate sizing and verification, refer to the dimension specifications. The provided label guides are for suggestion purposes only, and labels can be adjusted as needed.



AVIATOR® BOTTLE

SKU: CGAB1-20ML

LABEL SIZE SUGGESTION: **inch** | 2.59" W x 2.1" H **mm** | 66 mm W x 53.34 mm H

CAPACITY: 20 mL 0.68 oz.

--- Safe area
— Trim
— Bleed

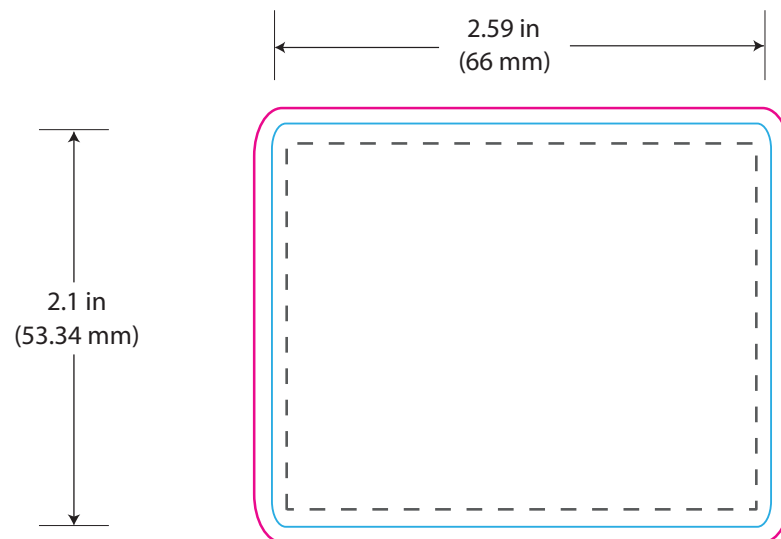

AVIATOR® BOTTLE

CGAB1-20ML

20 mL

Please note that the label template may not be to scale. For accurate sizing and verification, refer to the dimension specifications. The provided label guides are for suggestion purposes only, and labels can be adjusted as needed.

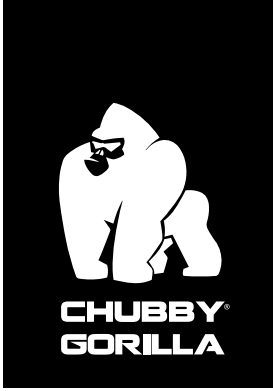

AVIATOR® BOTTLE

SKU: CGAB1-30ML

LABEL SIZE SUGGESTION:

inch | 2.6" W x 3.25" H

mm | 66.04 mm W x 82.55 mm H

CAPACITY:

30 mL

1.01 oz.

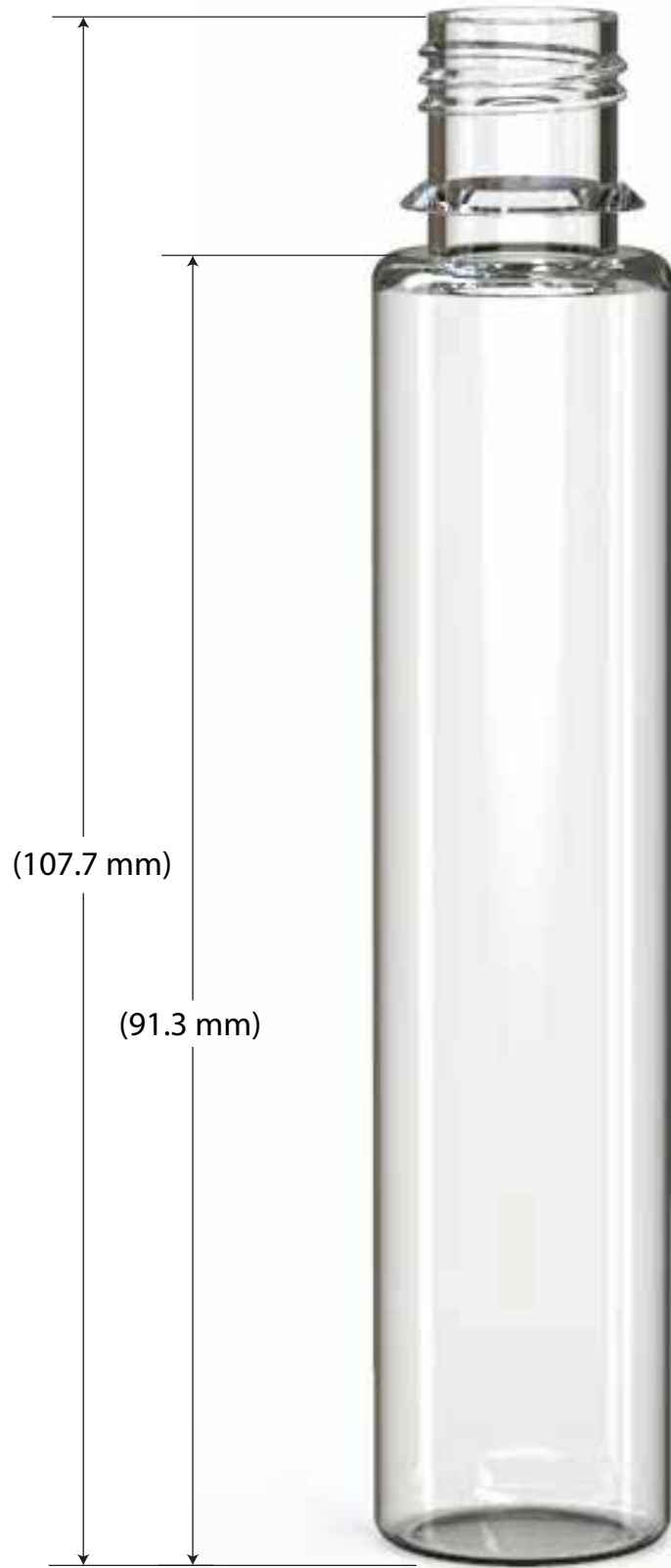
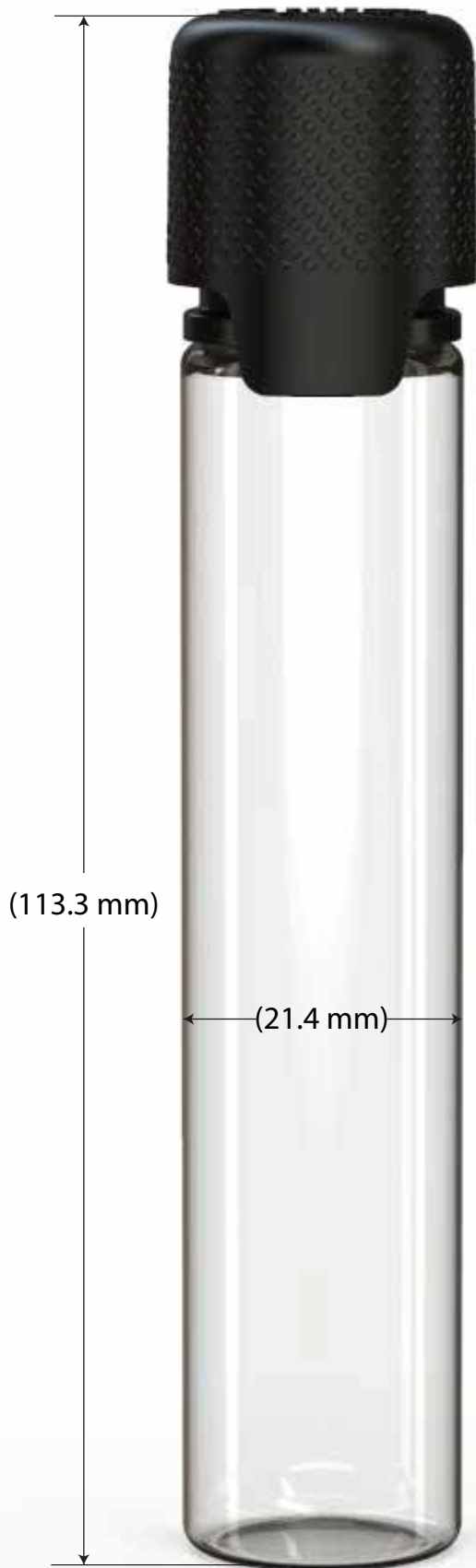
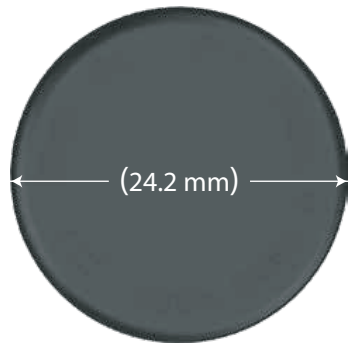

AVIATOR® BOTTLE

CGAB1-20ML

Label guide →

Please note that the label template may not be to scale. For accurate sizing and verification, refer to the dimension specifications. The provided label guides are for suggestion purposes only, and labels can be adjusted as needed.

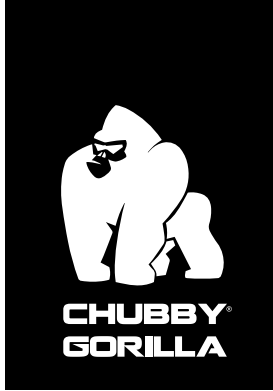

AVIATOR® BOTTLE

SKU: CGAB1-30ML

LABEL SIZE SUGGESTION: **inch** | 2.6" W x 3.25" H **mm** | 66.04 mm W x 82.55 mm H

CAPACITY: 30 mL 1.01 oz.

--- Safe area
— Trim
— Bleed

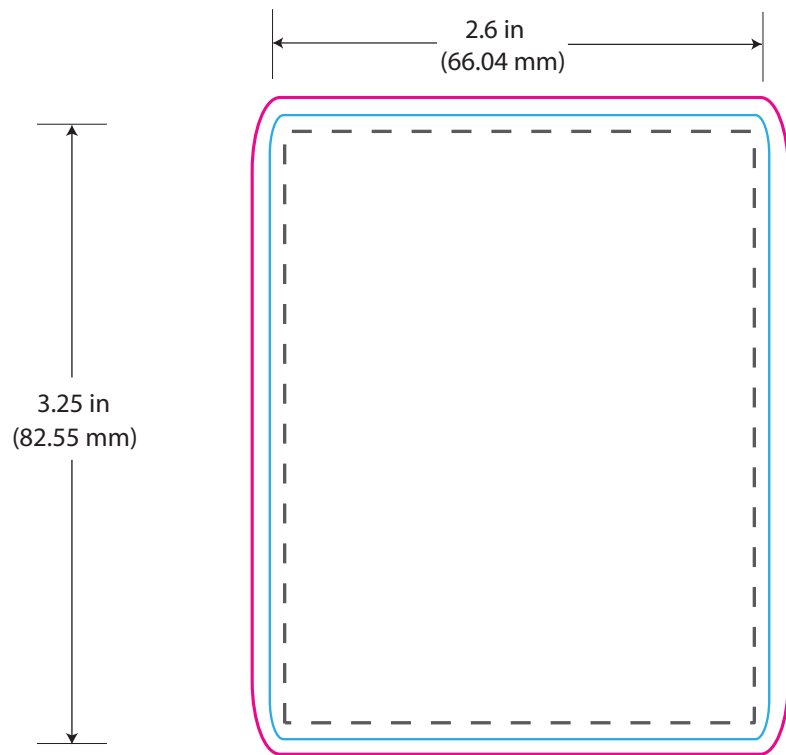

AVIATOR® BOTTLE

CGAB1-30ML

30 mL

Please note that the label template may not be to scale. For accurate sizing and verification, refer to the dimension specifications. The provided label guides are for suggestion purposes only, and labels can be adjusted as needed.

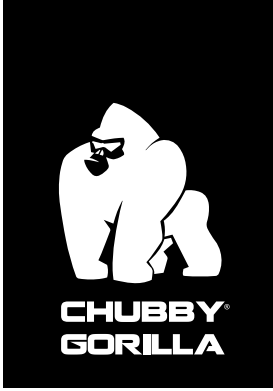

AVIATOR® BOTTLE

SKU: CGAB1-30MLSC

LABEL SIZE SUGGESTION:

inch | 3.65" W x 1.6" H

mm | 92.71 mm W x 40.64 mm H

CAPACITY:

30 mL

1.01 oz.



AVIATOR® BOTTLE

CGAB1-30MLSC

Label guide →

Please note that the label template may not be to scale. For accurate sizing and verification, refer to the dimension specifications. The provided label guides are for suggestion purposes only, and labels can be adjusted as needed.



AVIATOR® BOTTLE

SKU: CGAB1-30MLSC

LABEL SIZE SUGGESTION: **inch** | 3.65" W x 1.6" H **mm** | 92.71 mm W x 40.64 mm H

CAPACITY: 30 mL 1.01 oz.

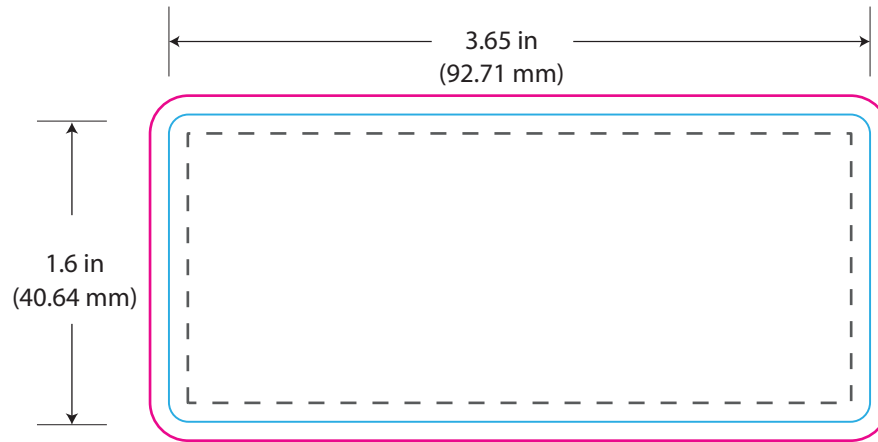
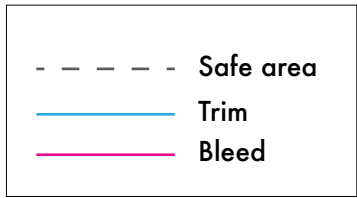

AVIATOR® BOTTLE

CGAB1-30MLSC

30 mL

Please note that the label template may not be to scale. For accurate sizing and verification, refer to the dimension specifications. The provided label guides are for suggestion purposes only, and labels can be adjusted as needed.

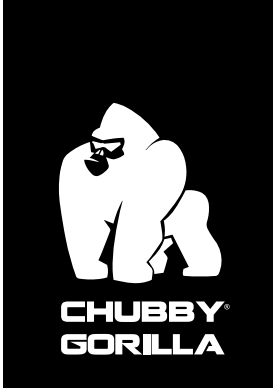

AVIATOR® BOTTLE

SKU: CGAB1-50ML

LABEL SIZE SUGGESTION:

inch | 3.65" W x 2.75" H **mm** | 92.71 mm W x 69.85 mm H

CAPACITY:

50 mL

1.69 oz.



(32.6 mm)

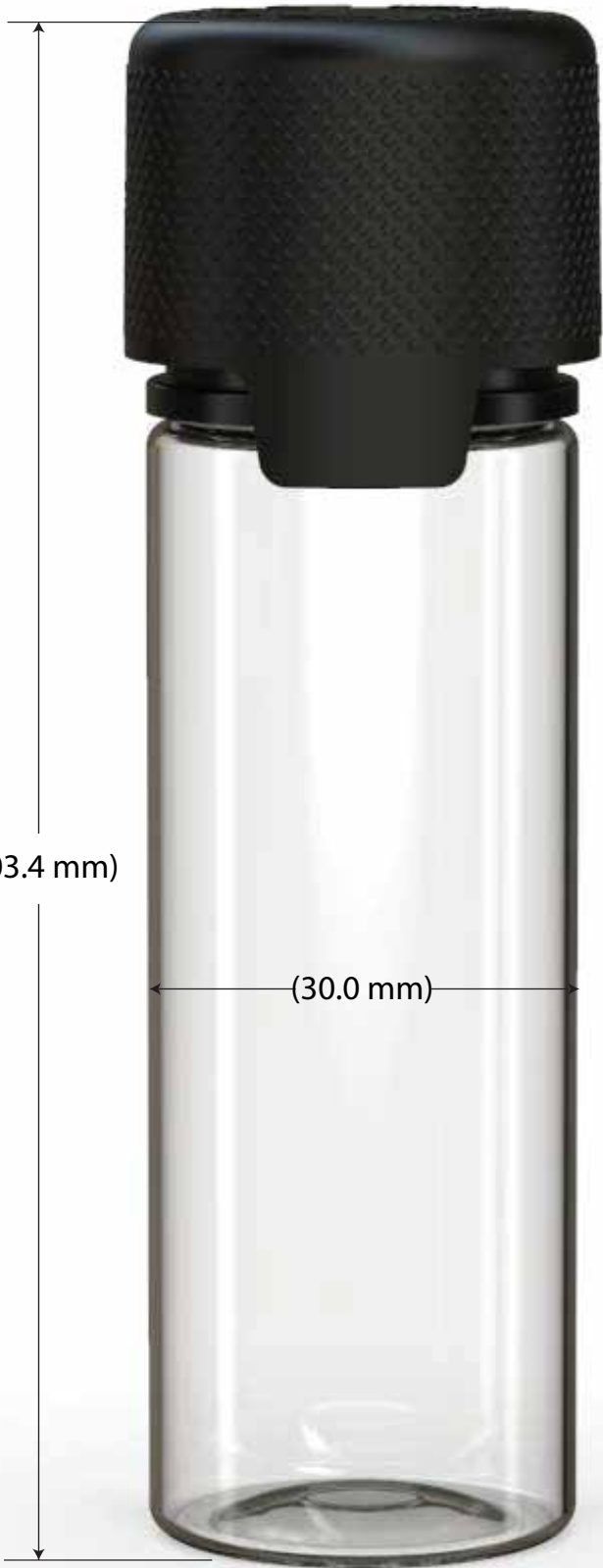

(103.4 mm)

(30.0 mm)



(96.4 mm)

(77.5 mm)



AVIATOR® BOTTLE

CGAB1-50ML

Label guide →

Please note that the label template may not be to scale. For accurate sizing and verification, refer to the dimension specifications. The provided label guides are for suggestion purposes only, and labels can be adjusted as needed.

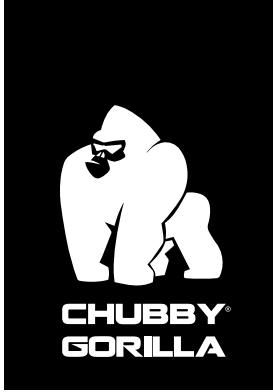

AVIATOR® BOTTLE

SKU: CGAB1-50ML

LABEL SIZE SUGGESTION: **inch** | 3.65" W x 2.75" H **mm** | 92.71 mm W x 69.85 mm H

CAPACITY: 50 mL 1.69 oz.

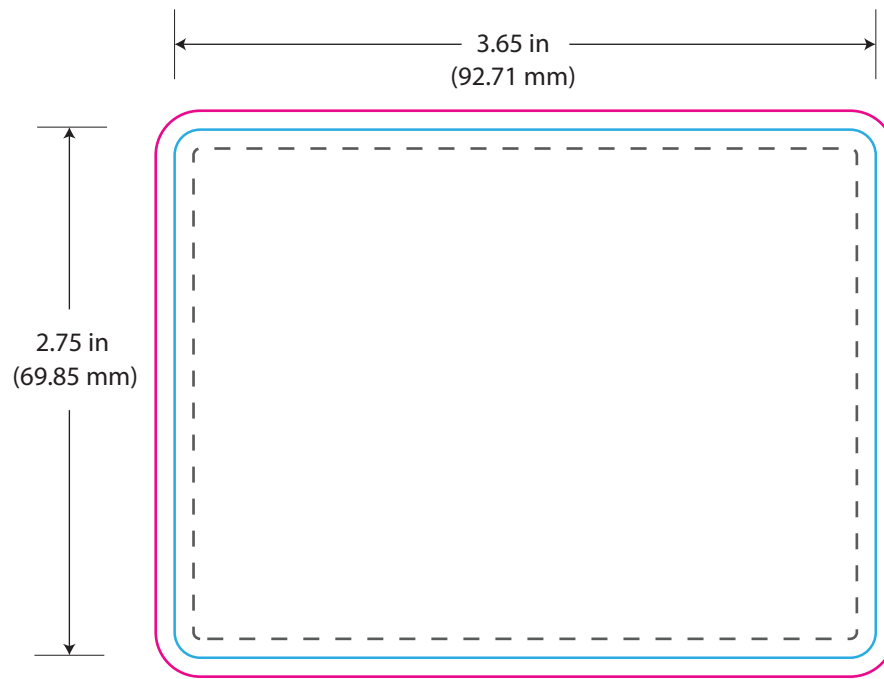
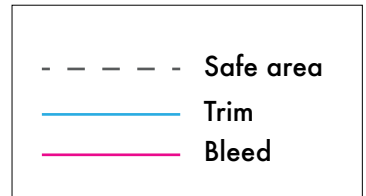

AVIATOR® BOTTLE

CGAB1-50MLV3

50 mL

Please note that the label template may not be to scale. For accurate sizing and verification, refer to the dimension specifications.
The provided label guides are for suggestion purposes only, and labels can be adjusted as needed.

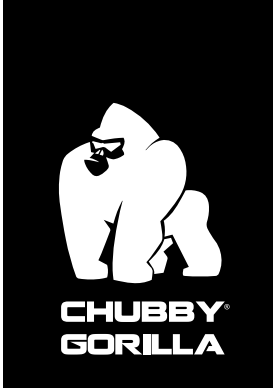

AVIATOR® BOTTLE

SKU: CGAB1-60ML

LABEL SIZE SUGGESTION:

inch | 3.65" W x 3.25" H

mm | 92.71 mm W x 82.55 mm H

CAPACITY:

60 mL

2.03 oz.



AVIATOR® BOTTLE

CGAB1-60ML

Label guide →

Please note that the label template may not be to scale. For accurate sizing and verification, refer to the dimension specifications. The provided label guides are for suggestion purposes only, and labels can be adjusted as needed.

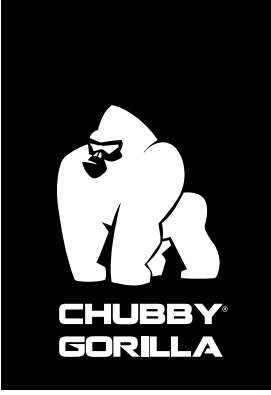

AVIATOR® BOTTLE

SKU: CGAB1-60ML

LABEL SIZE SUGGESTION: **inch** | 3.65" W x 3.25" H **mm** | 92.71 mm W x 82.55 mm H

CAPACITY: 60 mL 2.03 oz.

--- Safe area
— Trim
— Bleed

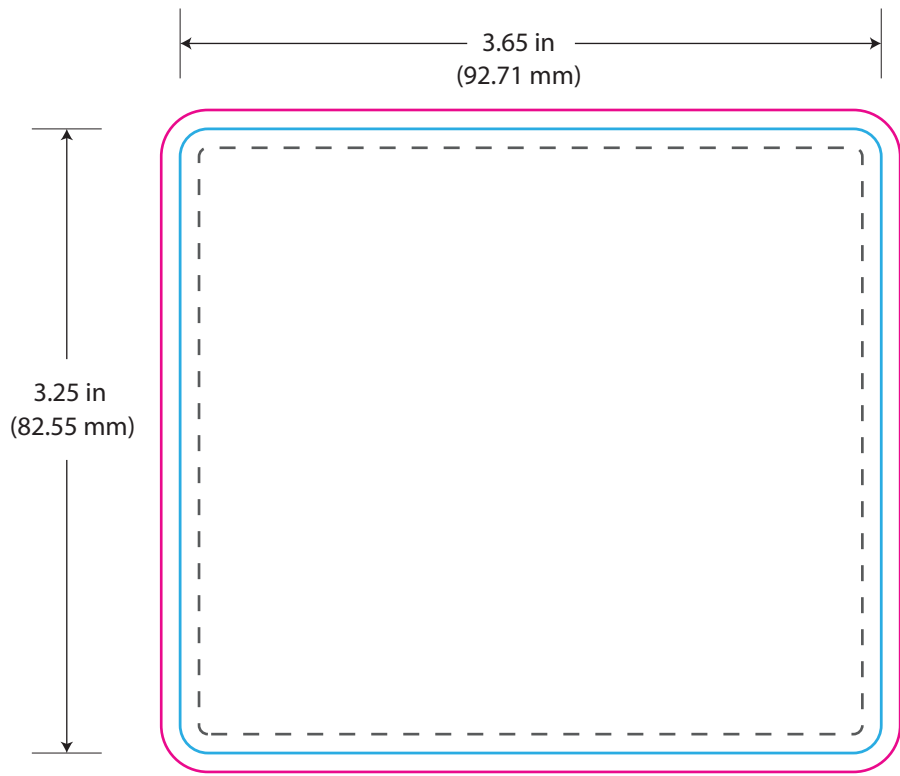

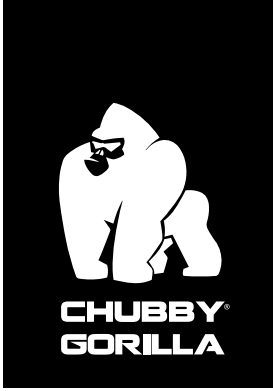

AVIATOR® BOTTLE

SKU: CGAB1-60MLM

LABEL SIZE SUGGESTION:

inch | 4.6" W x 1.9" H

mm | 117 mm W x 48 mm H

CAPACITY:

60 mL

2.03 oz.

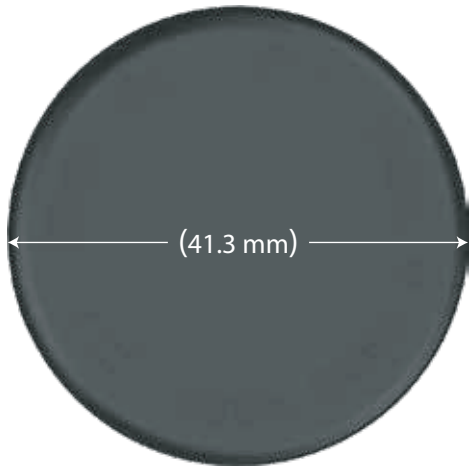

AVIATOR® BOTTLE

CGAB1-60MLM

Label guide →

Please note that the label template may not be to scale. For accurate sizing and verification, refer to the dimension specifications. The provided label guides are for suggestion purposes only, and labels can be adjusted as needed.

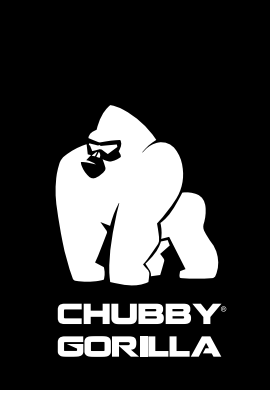

AVIATOR® BOTTLE

SKU: CGAB1-60MLM

LABEL SIZE SUGGESTION: **inch** | 4.6" W x 1.9" H **mm** | 117 mm W x 48 mm H

CAPACITY: 60 mL 2.03 oz.

--- Safe area
— Trim
— Bleed

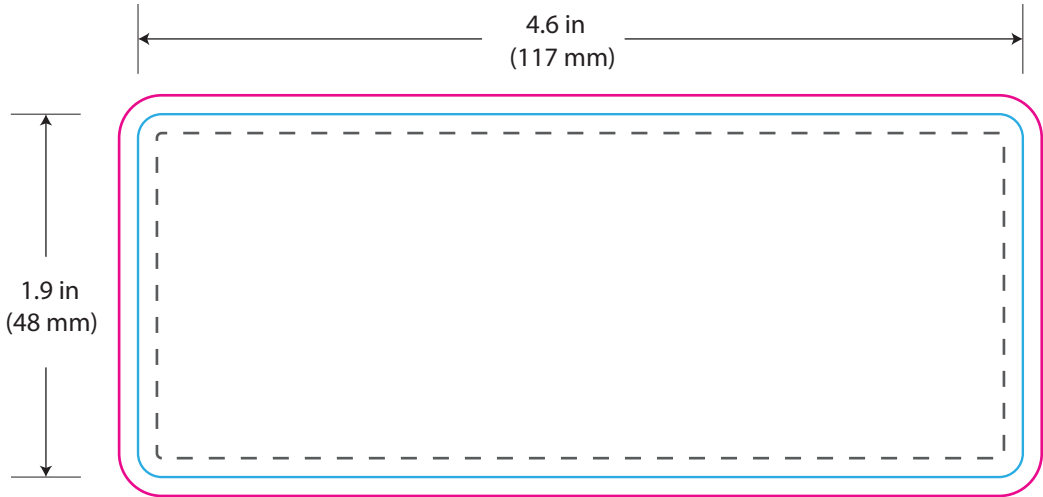

AVIATOR® BOTTLE

CGAB1-60MLM

60 mL

Please note that the label template may not be to scale. For accurate sizing and verification, refer to the dimension specifications. The provided label guides are for suggestion purposes only, and labels can be adjusted as needed.

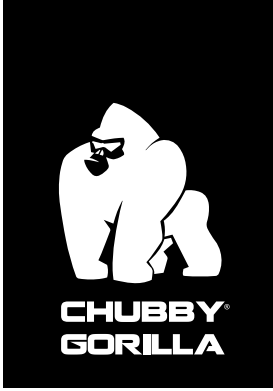

AVIATOR® BOTTLE

SKU: CGAB1-100ML

LABEL SIZE SUGGESTION:

inch | 5" W x 2.75" H

mm | 127 mm W x 70 mm H

CAPACITY:

100 mL

3.38 oz.



AVIATOR® BOTTLE

CGAB1-100ML

Label guide →

Please note that the label template may not be to scale. For accurate sizing and verification, refer to the dimension specifications. The provided label guides are for suggestion purposes only, and labels can be adjusted as needed.



AVIATOR® BOTTLE

SKU: CGAB1-100ML

LABEL SIZE SUGGESTION:

inch | 5" W x 2.75" H

mm | 127 mm W x 70 mm H

CAPACITY:

100 mL.

3.38 oz.

- - - - - Safe area
— Trim
— Bleed

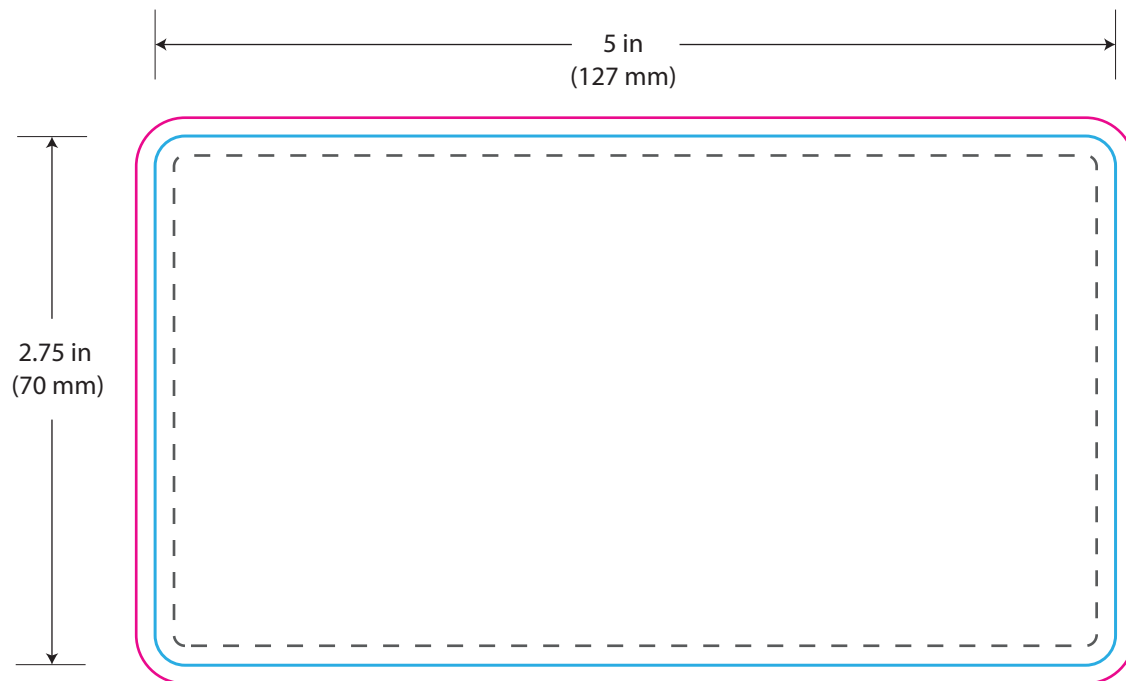

AVIATOR® BOTTLE

CGAB1-100MLV3

100 mL

Please note that the label template may not be to scale. For accurate sizing and verification, refer to the dimension specifications. The provided label guides are for suggestion purposes only, and labels can be adjusted as needed.

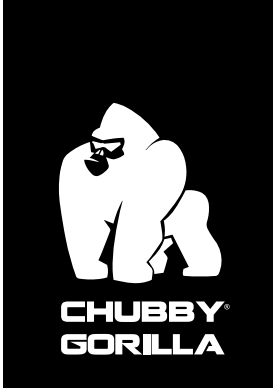

AVIATOR® BOTTLE

SKU: CGAB1-120ML

LABEL SIZE SUGGESTION:

inch | 5.0" W x 3.25" H

mm | 127 mm W x 82.55 mm H

CAPACITY:

120 mL

4.06 oz.



AVIATOR® BOTTLE

CGAB1-120ML

Label guide →

Please note that the label template may not be to scale. For accurate sizing and verification, refer to the dimension specifications. The provided label guides are for suggestion purposes only, and labels can be adjusted as needed.

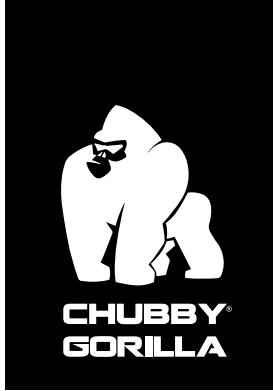

AVIATOR® BOTTLE

SKU: CGAB1-120ML

LABEL SIZE SUGGESTION: **inch** | 5.0" W x 3.25" H **mm** | 127 mm W x 82.55 mm H

CAPACITY: 120 mL 4.06 oz.

--- Safe area
— Trim
— Bleed

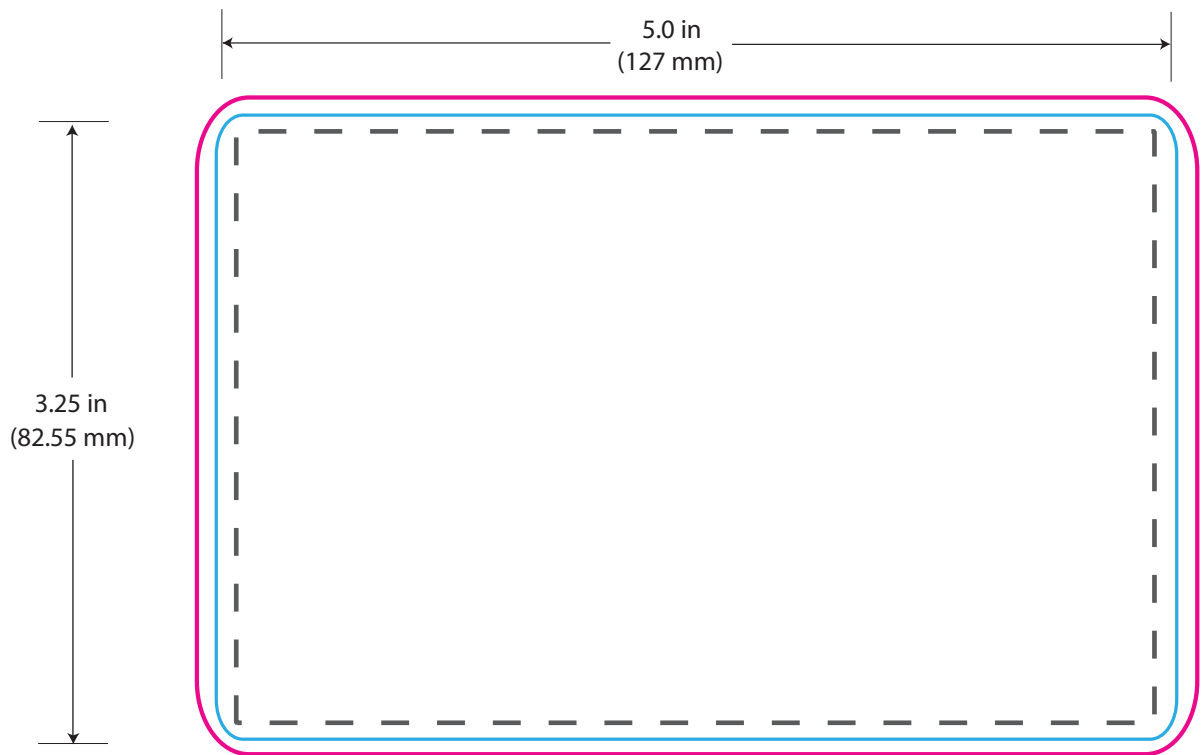

AVIATOR® BOTTLE

CGAB1-120ML

120 mL

Please note that the label template may not be to scale. For accurate sizing and verification, refer to the dimension specifications. The provided label guides are for suggestion purposes only, and labels can be adjusted as needed.

AVIATOR® TUBES

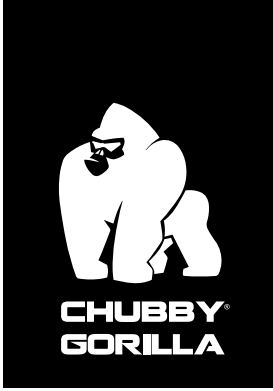

AVIATOR® TUBE

SKU: CGAT6-100MM

LABEL SIZE SUGGESTION:

inch | 2.44" W x 3" H

mm | 62 mm W x 76.2 mm H

CAPACITY:

0.44 oz.

13 mL

13 cc

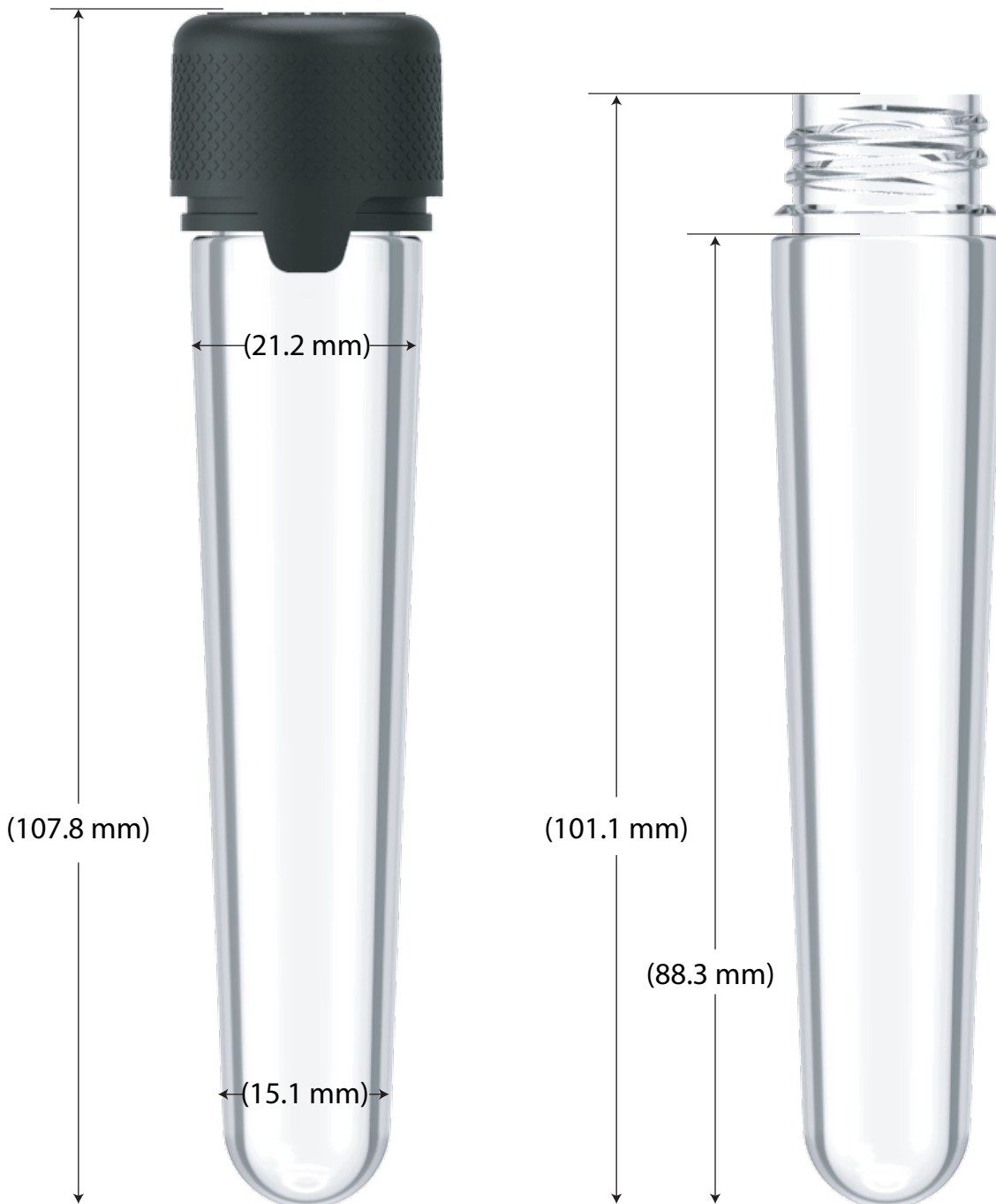

AVIATOR® TUBE

CGAT6-100MM

Label guide →

Please note that the label template may not be to scale. For accurate sizing and verification, refer to the dimension specifications. The provided label guides are for suggestion purposes only, and labels can be adjusted as needed.

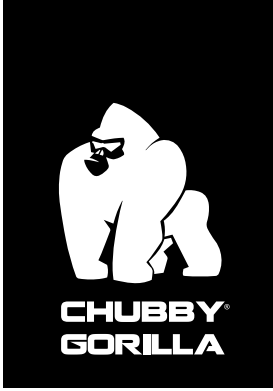

AVIATOR® TUBE

SKU: CGAT6-100MM

LABEL SIZE SUGGESTION: **inch** | 2.44" W x 3" H **mm** | 62 mm W x 76.2 mm H

CAPACITY: 0.44 oz. 13 mL 13 cc

--- Safe area
— Trim
— Bleed

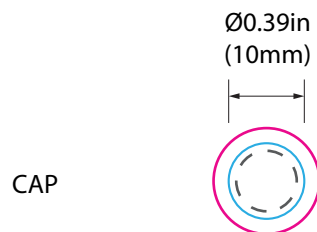
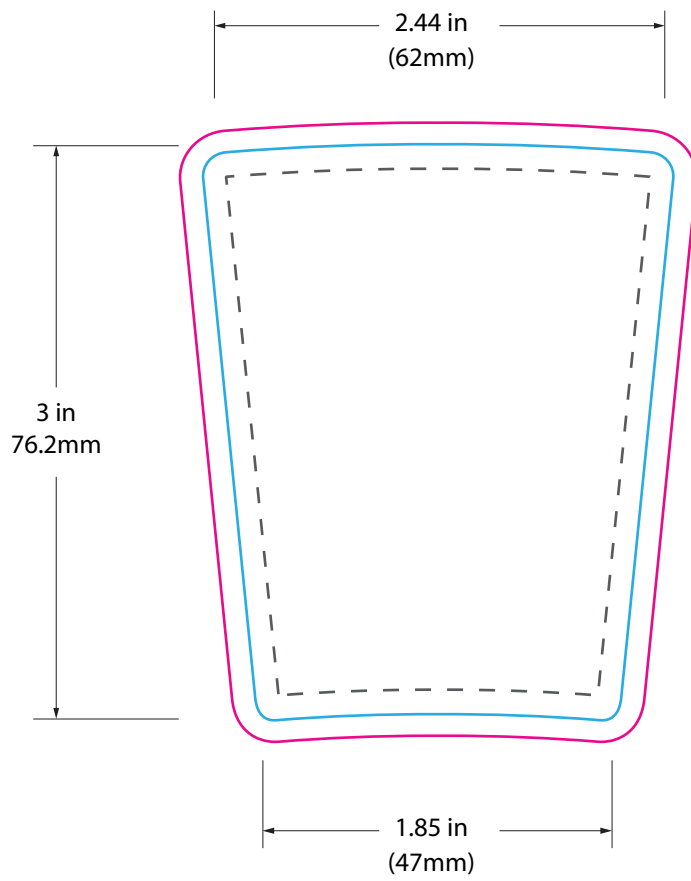

AVIATOR® TUBE

CGAT6-100MM

100 mm (length)

Please note that the label template may not be to scale. For accurate sizing and verification, refer to the dimension specifications. The provided label guides are for suggestion purposes only, and labels can be adjusted as needed.

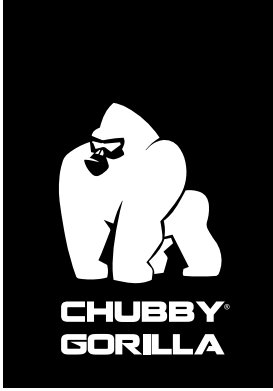

AVIATOR® TUBE

SKU: CGAT1-100MMF

LABEL SIZE SUGGESTION:

inch | 2.48" W x 3.54" H

mm | 63 mm W x 90 mm H

CAPACITY:

TBA

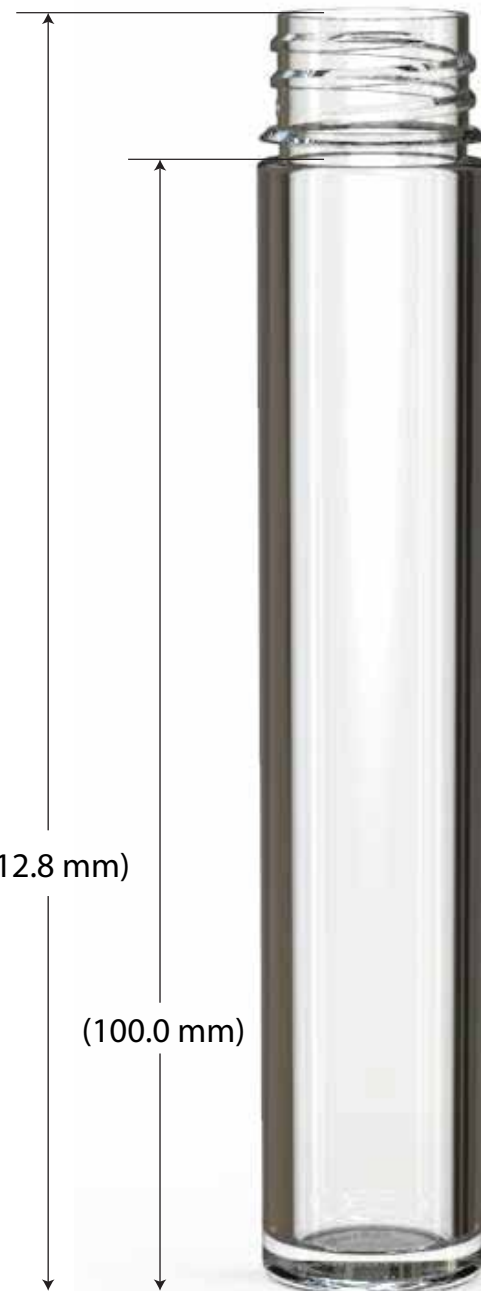

AVIATOR® TUBE

CGAT1-100MMF

Label guide →

Please note that the label template may not be to scale. For accurate sizing and verification, refer to the dimension specifications. The provided label guides are for suggestion purposes only, and labels can be adjusted as needed.

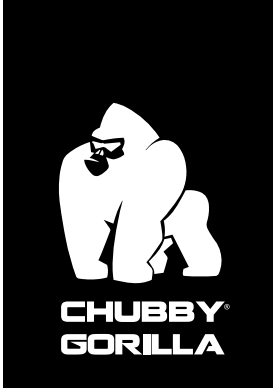

AVIATOR® TUBE

SKU: CGAT1-100MMF

LABEL SIZE SUGGESTION: **inch** | 2.48" W x 3.54" H **mm** | 63 mm W x 90 mm H

CAPACITY: TBA

- - - - - Safe area
— Trim
— Bleed

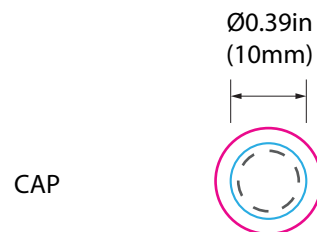
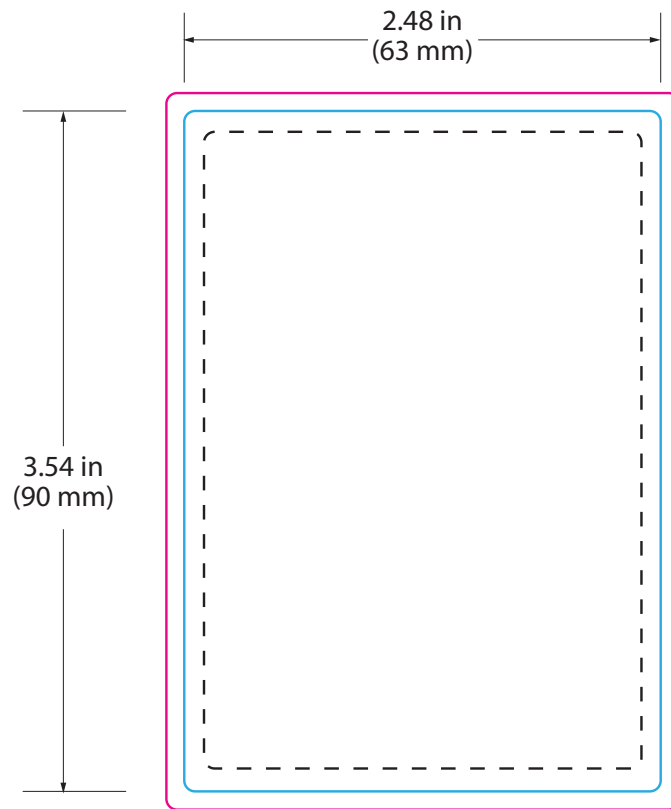

AVIATOR® TUBE

CGAT1-100MMF

100 mm (length)

Please note that the label template may not be to scale. For accurate sizing and verification, refer to the dimension specifications. The provided label guides are for suggestion purposes only, and labels can be adjusted as needed.

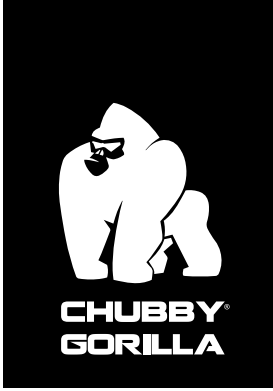

AVIATOR® TUBE

SKU: CGAT6-113MM

LABEL SIZE SUGGESTION: **inch** | 2.36" W x 3.57" H **mm** | 60 mm W x 90.8 mm H

CAPACITY: 0.34 oz. 10 mL 10 cc



AVIATOR® TUBE

CGAT6-113MM

Label guide →

Please note that the label template may not be to scale. For accurate sizing and verification, refer to the dimension specifications. The provided label guides are for suggestion purposes only, and labels can be adjusted as needed.

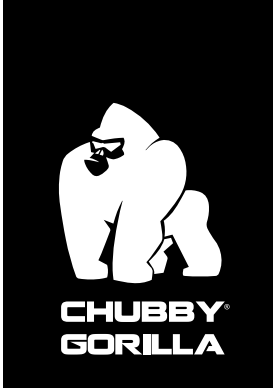

AVIATOR® TUBE

SKU: CGAT6-113MM

LABEL SIZE SUGGESTION: **inch** | 2.36" W x 3.57" H **mm** | 60 mm W x 90.8 mm H

CAPACITY: 0.34 oz. 10 mL 10 cc

--- Safe area
— Trim
— Bleed

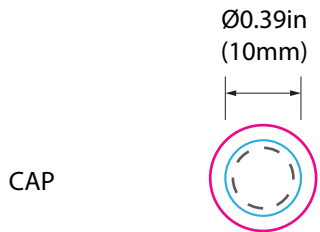
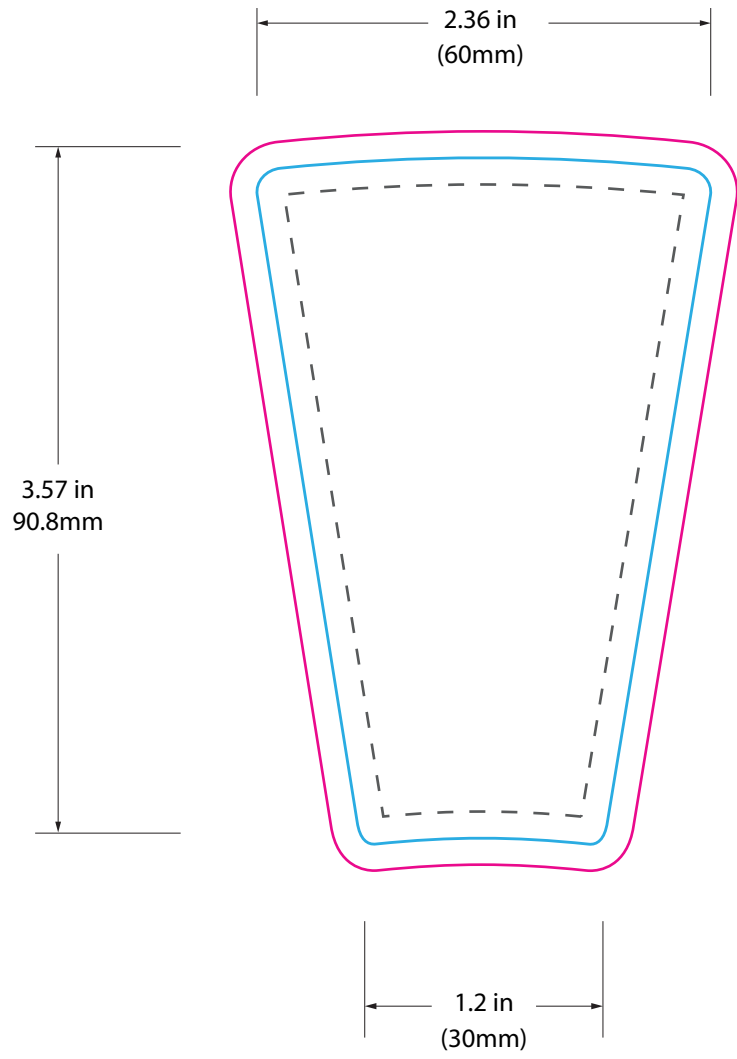

AVIATOR® TUBE

CGAT6-113MM

113 mm (length)

Please note that the label template may not be to scale. For accurate sizing and verification, refer to the dimension specifications. The provided label guides are for suggestion purposes only, and labels can be adjusted as needed.

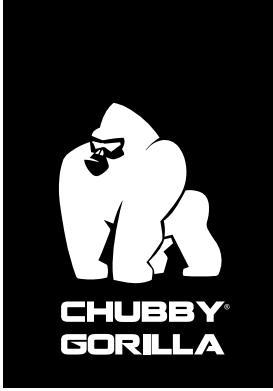

AVIATOR® TUBE

SKU: CGAT6-120MM

LABEL SIZE SUGGESTION:

inch | 2.43" W x 3.75" H

mm | 61.87 mm W x 95.26 mm H

CAPACITY:

0.61 oz.

18 mL

18 cc

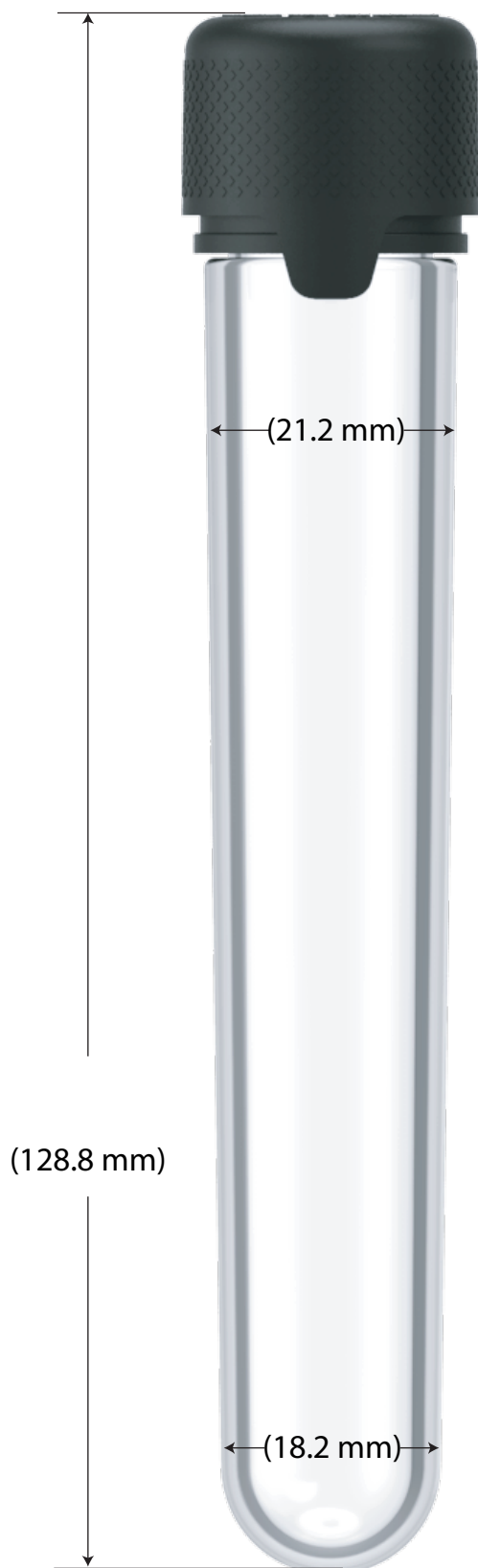

AVIATOR® TUBE

CGAT6-120MM

Label guide →

Please note that the label template may not be to scale. For accurate sizing and verification, refer to the dimension specifications. The provided label guides are for suggestion purposes only, and labels can be adjusted as needed.

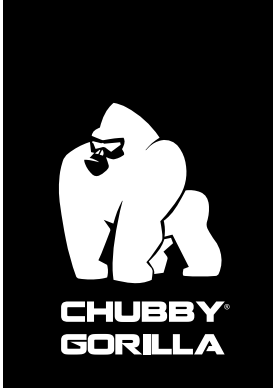

AVIATOR® TUBE

SKU: CGAT6-120MM

LABEL SIZE SUGGESTION: **inch** | 2.43" W x 3.75" H **mm** | 61.87 mm W x 95.26 mm H

CAPACITY: 0.61 oz. 18 mL 18 cc

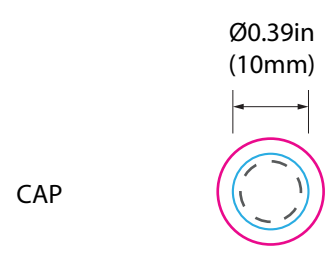
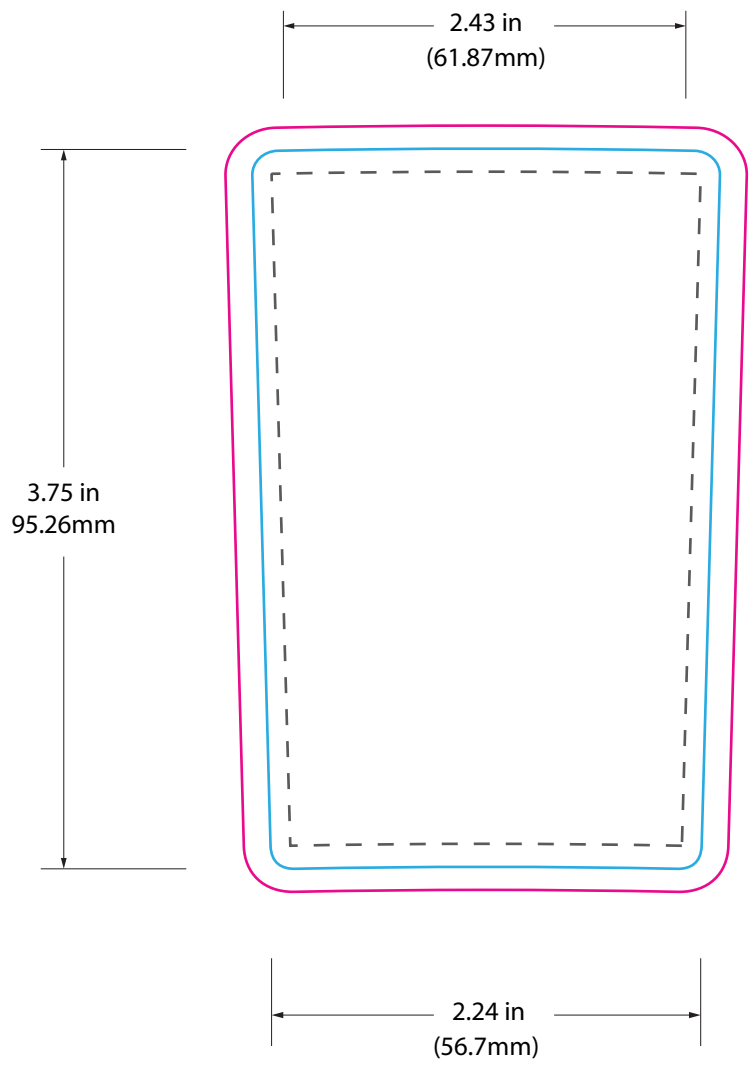
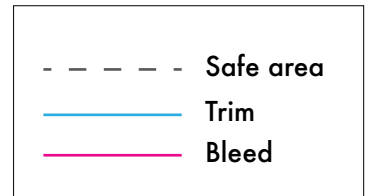

AVIATOR® TUBE

CGAT6-120MM

120 mm (length)

Please note that the label template may not be to scale. For accurate sizing and verification, refer to the dimension specifications. The provided label guides are for suggestion purposes only, and labels can be adjusted as needed.

AVIATOR® CARTRIDGE CONTAINERS

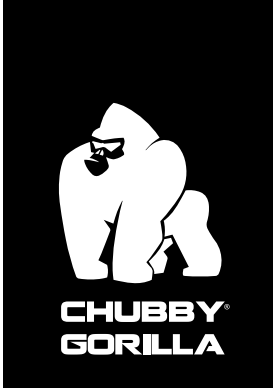

AVIATOR® 510 CARTRIDGE CONTAINER

SKU: CGAC1-510R

LABEL SIZE SUGGESTION: **inch** | 1.97" W x 2.36" H **mm** | 50 mm W x 60 mm H

CAPACITY: 65 mm



(Cartridge not included)



Please note that the label template may not be to scale. For accurate sizing and verification, refer to the dimension specifications. The provided label guides are for suggestion purposes only, and labels can be adjusted as needed.

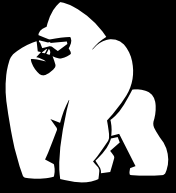

**CHUBBY
GORILLA**

AVIATOR® 510 CARTRIDGE CONTAINER

SKU: CGAC1-510R

LABEL SIZE SUGGESTION: **inch** | 1.97" W x 2.36" H **mm** | 50 mm W x 60 mm H

CAPACITY: 65 mm

- - - - - Safe area
— Trim
— Bleed

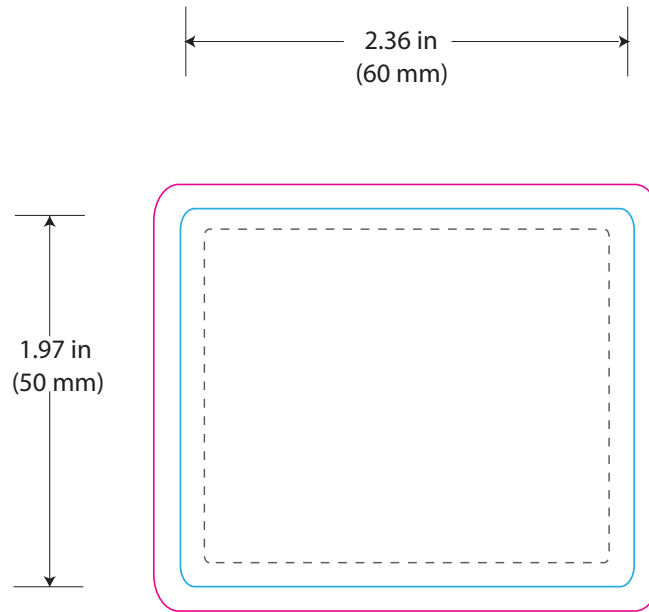

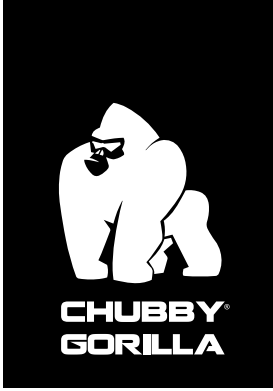

AVIATOR® 510 CARTRIDGE CONTAINER

SKU: CGAC1-510F

LABEL SIZE SUGGESTION:	inch 2.36" W x 2.17" H	mm 60 mm W x 55 mm H
	<hr/>	

CAPACITY:	65 mm
------------------	-------

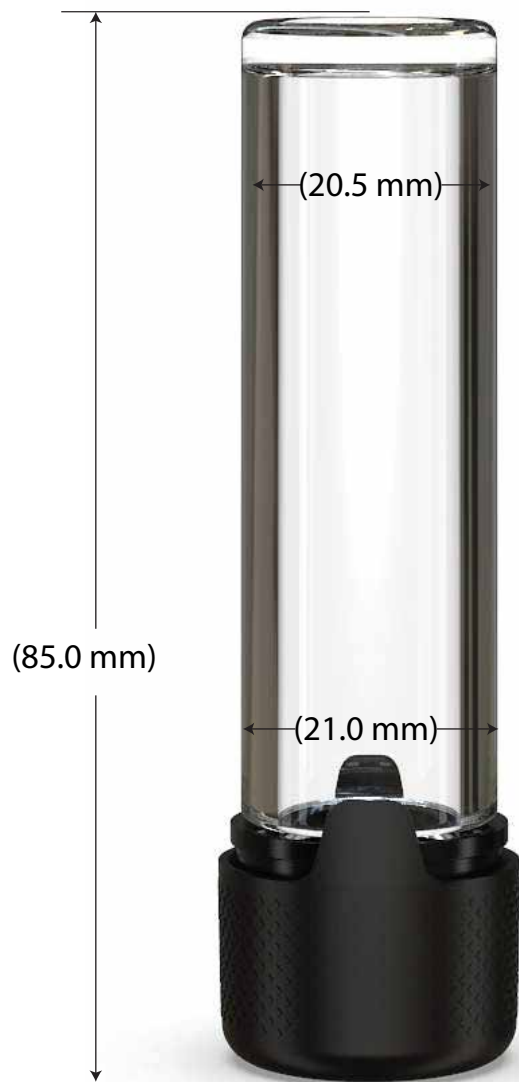

AVIATOR® 510 CARTRIDGE CONTAINER

CGAC1-510F

Label guide →

Please note that the label template may not be to scale. For accurate sizing and verification, refer to the dimension specifications. The provided label guides are for suggestion purposes only, and labels can be adjusted as needed.

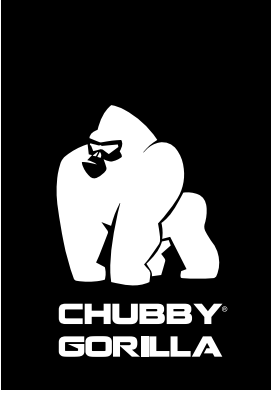

AVIATOR® 510 CARTRIDGE CONTAINER

SKU: CGAC1-510F

LABEL SIZE SUGGESTION: **inch** | 2.36" W x 2.17" H **mm** | 60 mm W x 55 mm H

CAPACITY: 65 mm

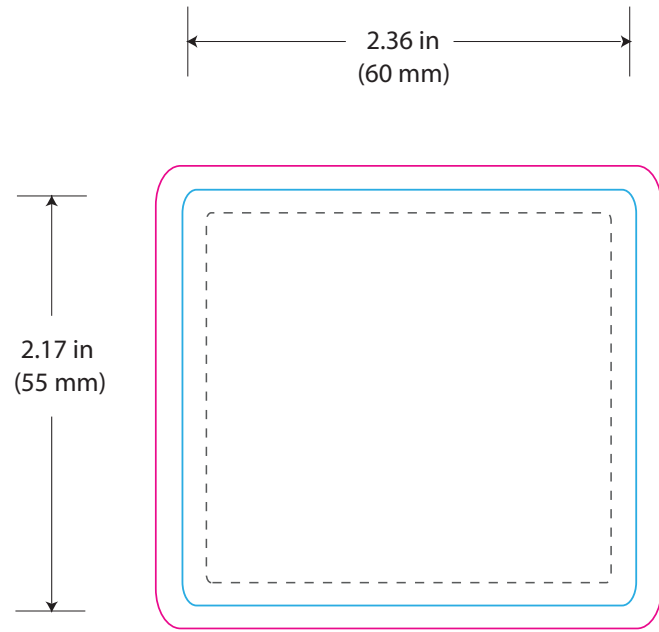
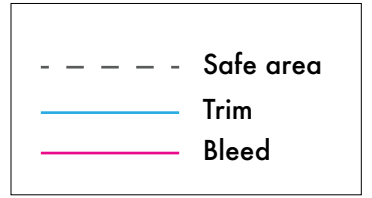

AVIATOR® BASE BOTTLES

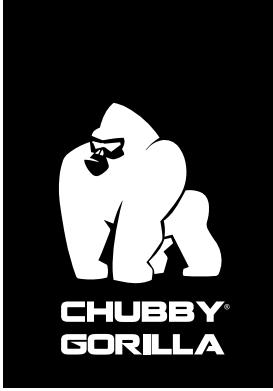

AVIATOR® BASE BOTTLE

SKU: CGABB1-250ML

LABEL SIZE SUGGESTION:

inch | 9.84" W x 1.77" H

mm | 250 mm W x 45 mm H

CAPACITY:

250 mL

8.45 oz.



AVIATOR® BASE BOTTLE

CGABB1-250ML

Label guide →

Please note that the label template may not be to scale. For accurate sizing and verification, refer to the dimension specifications. The provided label guides are for suggestion purposes only, and labels can be adjusted as needed.

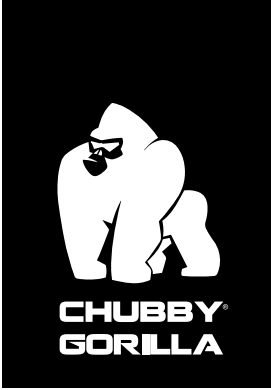

AVIATOR® BASE BOTTLE

SKU: CGABB1-250ML

LABEL SIZE SUGGESTION:

inch | 9.84" W x 1.77" H

mm | 250 mm W x 45 mm H

CAPACITY:

250 mL

8.45 oz.

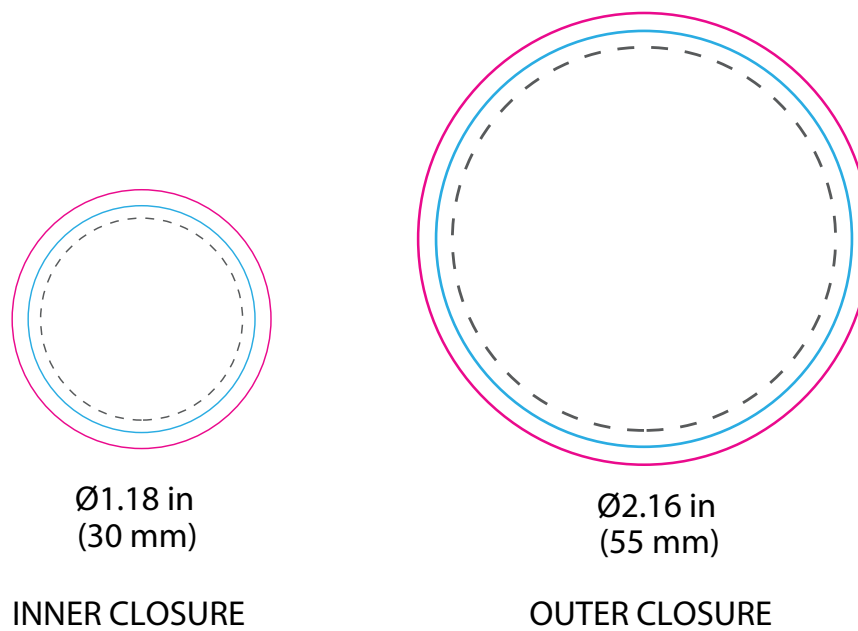
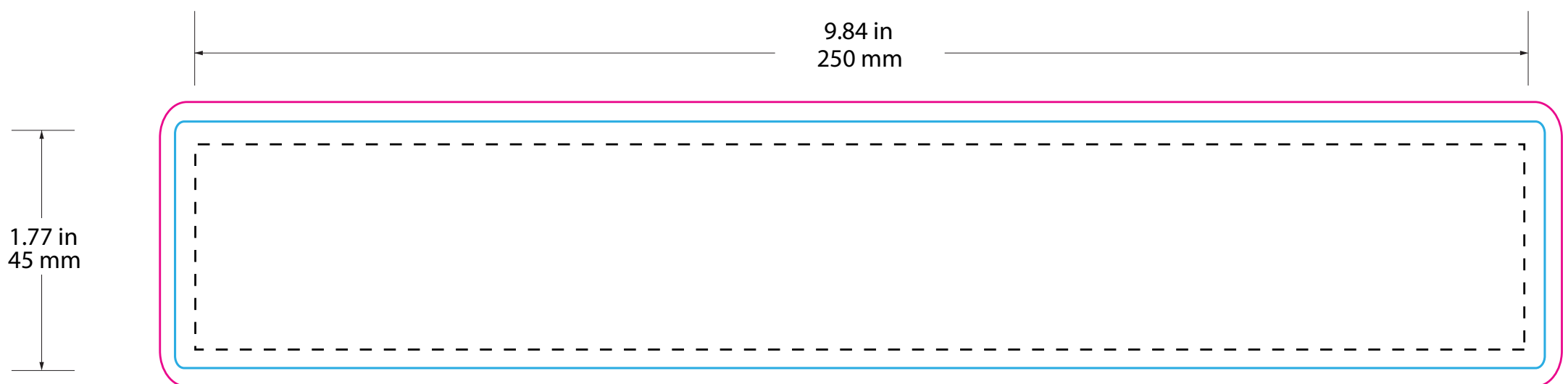
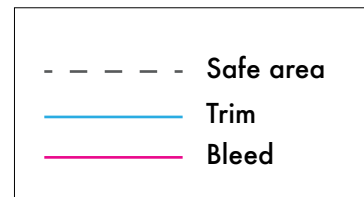

AVIATOR® BASE BOTTLE

CGABB1-250ML

250 mL

Please note that the label template may not be to scale. For accurate sizing and verification, refer to the dimension specifications. The provided label guides are for suggestion purposes only, and labels can be adjusted as needed.

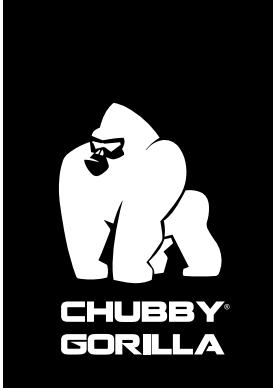

AVIATOR® BASE BOTTLE

SKU: CGABB1-500ML

LABEL SIZE SUGGESTION:

inch | 9.84" W x 3.54" H

mm | 250 mm W x 90 mm H

CAPACITY:

500 mL

16.90 oz.



AVIATOR® BASE BOTTLE

CGABB1-500ML

Label guide →

Please note that the label template may not be to scale. For accurate sizing and verification, refer to the dimension specifications. The provided label guides are for suggestion purposes only, and labels can be adjusted as needed.

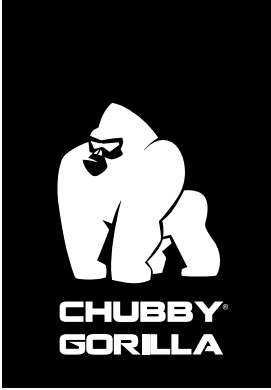

AVIATOR® BASE BOTTLE

SKU: CGABB1-500ML

LABEL SIZE SUGGESTION:

inch | 9.84" W x 3.54" H

mm | 250 mm W x 90 mm H

CAPACITY:

500 mL

16.90 oz.

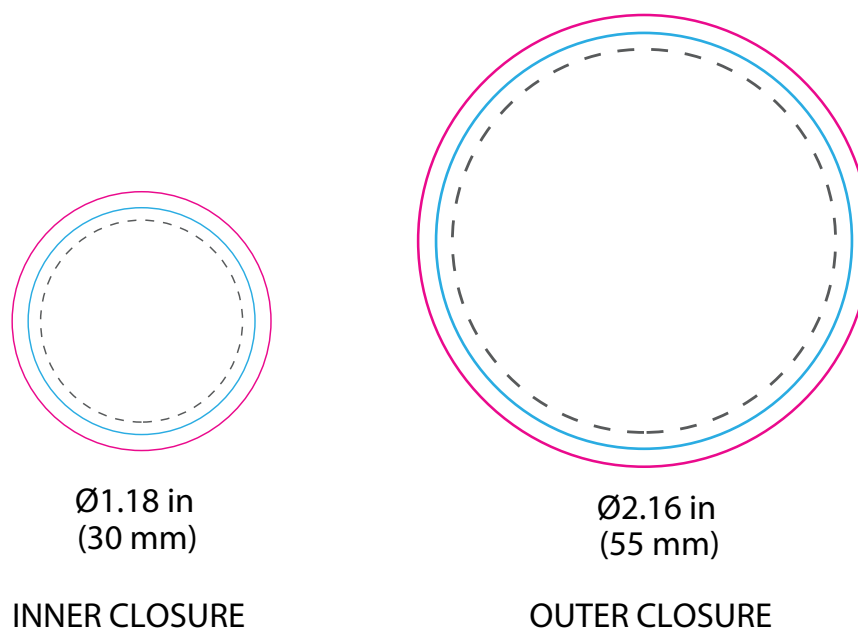
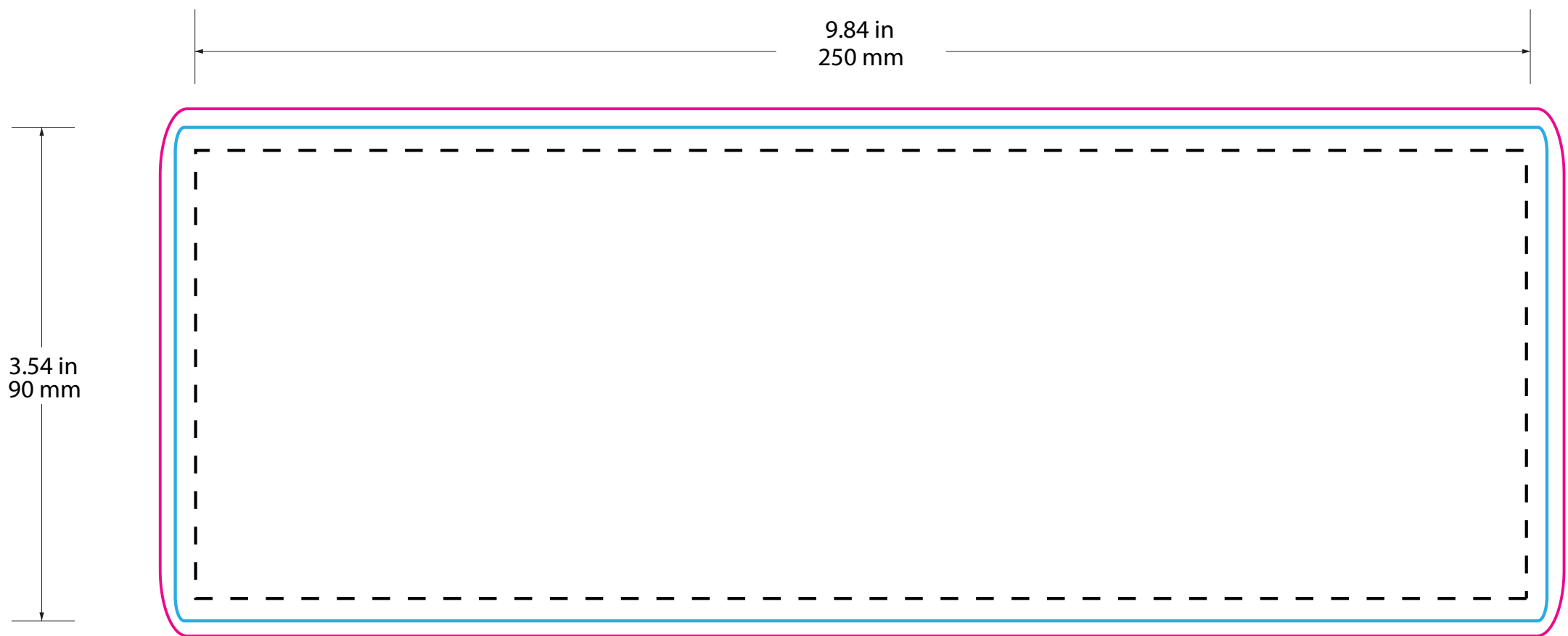
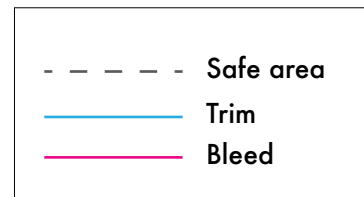

AVIATOR® BASE BOTTLE

CGABB1-500ML

500 mL

Please note that the label template may not be to scale. For accurate sizing and verification, refer to the dimension specifications. The provided label guides are for suggestion purposes only, and labels can be adjusted as needed.

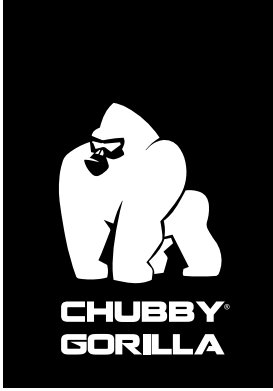

AVIATOR® BASE BOTTLE

SKU: CGABB1-1L

LABEL SIZE SUGGESTION:

inch | 9.84" W x 7.67" H

mm | 250 mm W x 195 mm H

CAPACITY:

1 L

33.81 oz.



AVIATOR® BASE BOTTLE

CGABB1-1L

Label guide →

Please note that the label template may not be to scale. For accurate sizing and verification, refer to the dimension specifications. The provided label guides are for suggestion purposes only, and labels can be adjusted as needed.

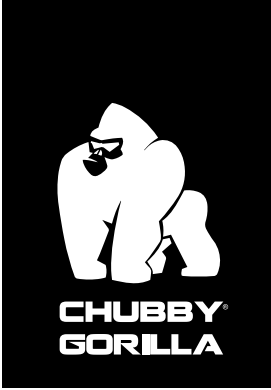

AVIATOR® BASE BOTTLE

SKU: CGABB1-1L

LABEL SIZE SUGGESTION:

inch | 9.84" W x 7.67" H

mm | 250 mm W x 195 mm H

CAPACITY:

1 L

33.81 oz.

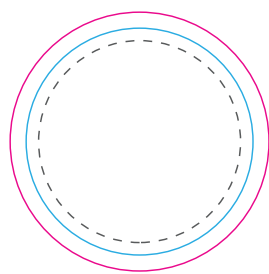
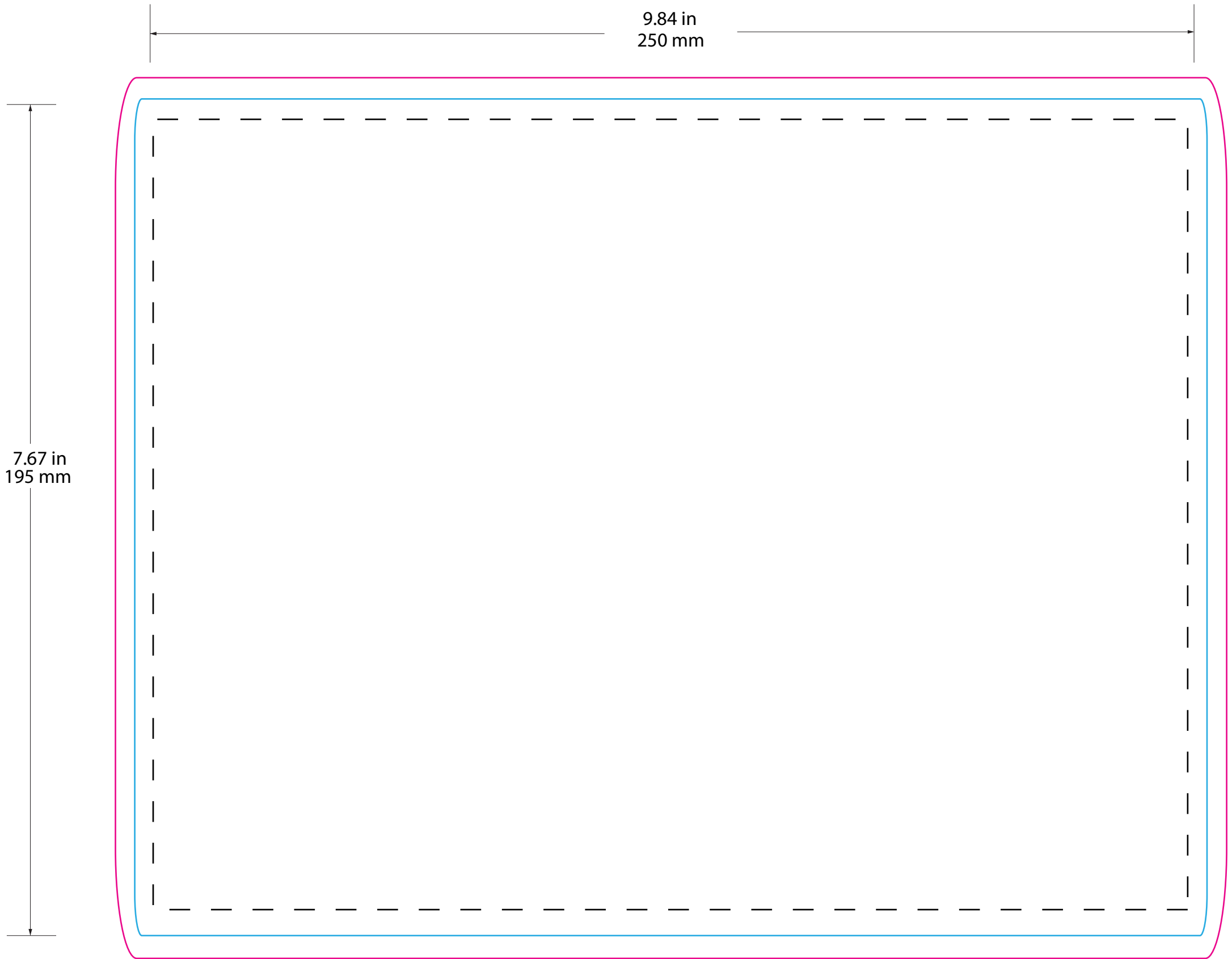

Ø1.18 in
(30 mm)

INNER CLOSURE

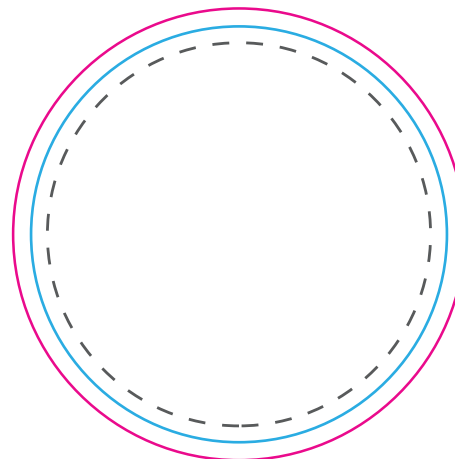

Ø2.16 in
(55 mm)

OUTER CLOSURE

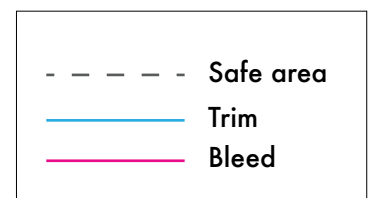

AVIATOR® BASE BOTTLE

CGABB1-1L

1 L

Please note that the label template may not be to scale. For accurate sizing and verification, refer to the dimension specifications. The provided label guides are for suggestion purposes only, and labels can be adjusted as needed.



A SPECIALTY PACKAGING COMPANY

CHUBBY GORILLA® IS A SPECIALTY PACKAGING MANUFACTURER,
ENGINEERING SOLUTIONS FOR EMERGING INDUSTRIES ACROSS THE GLOBE.

GLOBAL HEADQUARTERS
CHUBBY GORILLA INC.,
4320 NORTH HARBOR BLVD,
FULLERTON, CA. 92835, USA
+1 (844) 365 - 5218 | +1 (714) 253 - 3512

CHUBBY GORILLA EUROPE BV
SMITSPOL 4A
NIJKERK, 3861 RS
NETHERLANDS
WWW.CHUBBYGORILLA.COM

DESIGNED IN ORANGE COUNTY, CALIFORNIA, U.S.A | © 2022 CHUBBY GORILLA INC. - ALL RIGHTS RESERVED

CHUBBY GORILLA, THE FIGURATIVE GORILLA LOGO AND OTHER MARKS ARE REGISTERED, PENDING OR UNREGISTERED TRADEMARKS AND/OR COPYRIGHTS OF CHUBBY GORILLA, INC. IN THE U.S. AND/OR OTHER COUNTRIES. THESE PRODUCTS MAY BE COVERED BY ONE OR MORE PATENTS OR PATENT APPLICATIONS, SEE WWW.CHUBBYGORILLA.COM/PATENTS

PRODUCT USE: MANY FACTORS BEYOND CHUBBY GORILLA'S ("CG") CONTROL AND UNIQUELY WITHIN USER'S KNOWLEDGE AND CONTROL CAN AFFECT THE USE AND PERFORMANCE OF A CG PRODUCT IN A PARTICULAR APPLICATION. GIVEN THE VARIETY OF FACTORS THAT CAN AFFECT THE USE AND PERFORMANCE OF A CG PRODUCT, USER IS SOLELY RESPONSIBLE FOR EVALUATING THE CG PRODUCT AND DETERMINING WHETHER IT IS FIT FOR A PARTICULAR PURPOSE AND SUITABLE FOR USER'S METHOD OF APPLICATION, INCLUDING BUT NOT LIMITED TO, DETERMINING WHETHER THE PRODUCT(S) PLACED WITHIN ITS PACKAGING SOLUTIONS ARE COMPATIBLE WITH EACH PARTICULAR PACKAGING SOLUTION.

WARRANTY, LIMITED REMEDY, AND DISCLAIMER: UNLESS AN ADDITIONAL WARRANTY IS SPECIFICALLY STATED ON THE APPLICABLE CG PRODUCT PACKAGING OR PRODUCT LITERATURE, CG WARRANTS THAT EACH CG PRODUCT MEETS THE APPLICABLE CG PRODUCT SPECIFICATION AT THE TIME CG SHIPS THE PRODUCT. CHUBBY GORILLA MAKES NO OTHER WARRANTIES OR CONDITIONS, EXPRESS OR IMPLIED, INCLUDING, BUT NOT LIMITED TO, ANY IMPLIED WARRANTY OR CONDITION OF MERCHANTABILITY OR FITNESS FOR A PARTICULAR PURPOSE OR ANY IMPLIED WARRANTY OR CONDITION ARISING OUT OF A COURSE OF DEALING, CUSTOM OR USAGE OF TRADE. IF THE CG PRODUCT DOES NOT CONFORM TO THIS WARRANTY, THEN THE SOLE AND EXCLUSIVE REMEDY IS, AT CG'S OPTION, REPLACEMENT OF THE CG PRODUCT OR REFUND OF THE PURCHASE PRICE.

LIMITATION OF LIABILITY: EXCEPT WHERE PROHIBITED BY LAW, CG WILL NOT BE LIABLE FOR ANY LOSS OR DAMAGE ARISING FROM THE CG PRODUCT, WHETHER DIRECT, INDIRECT, SPECIAL, INCIDENTAL OR CONSEQUENTIAL, REGARDLESS OF THE LEGAL THEORY ASSERTED, INCLUDING WARRANTY, CONTRACT, NEGLIGENCE OR STRICT LIABILITY.