

SPIRAL

CONTAINERS, XL CONTAINERS, BOTTLES,
TUBES and CARTRIDGE CONTAINERS

DIMENSION & LABEL SUGGESTION GUIDE

SPIRAL CONTAINERS

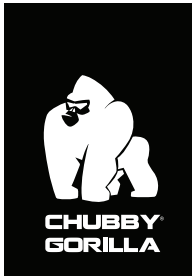

SPIRAL CONTAINER

SKU: CGSC1-2OZ

LABEL SIZE SUGGESTION:

inch | 6.49" W x 0.86" H

mm | 165 mm W x 22 mm H

CAPACITY:

2 oz.

60 cc

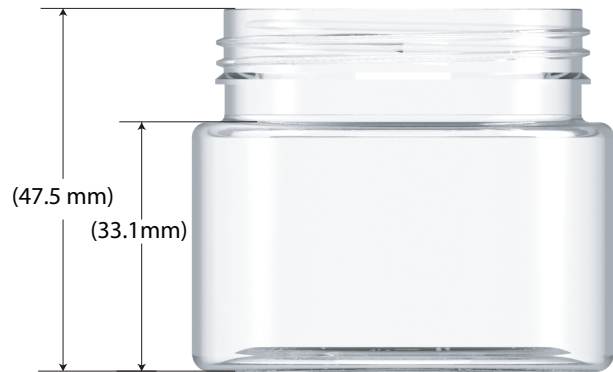

SPIRAL CONTAINER

CGSC1-2OZ

Label guide →

Please note that the label template may not be to scale. For accurate sizing and verification, refer to the dimension specifications. The provided label guides are for suggestion purposes only, and labels can be adjusted as needed.

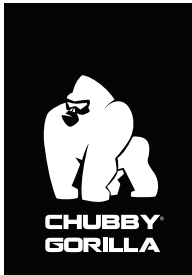

SPIRAL CONTAINER

SKU: CGSC1-2OZ

LABEL SIZE SUGGESTION:

inch | 6.49" W x 0.86" H

mm | 165 mm W x 22 mm H

CAPACITY:

2 oz.

60 cc

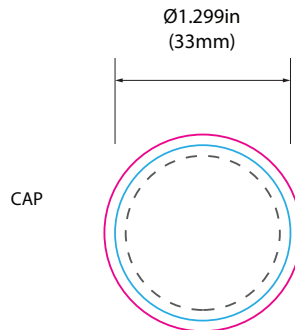
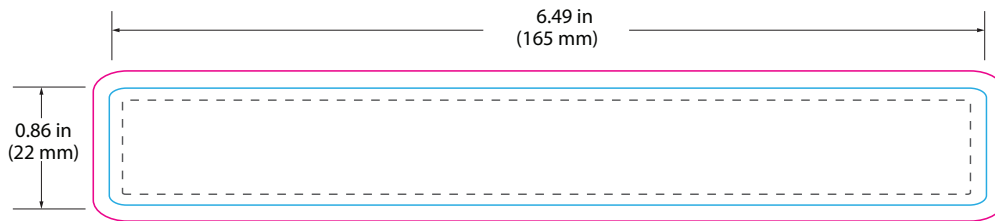
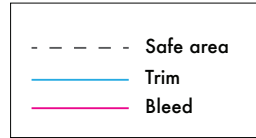

SPIRAL CONTAINER

CGSC1-2OZ

2 oz.

Please note that the label template may not be to scale. For accurate sizing and verification, refer to the dimension specifications. The provided label guides are for suggestion purposes only, and labels can be adjusted as needed.

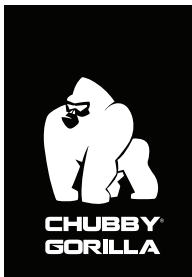

SPIRAL CONTAINER

SKU: CGSC1-3OZ

LABEL SIZE SUGGESTION:

inch | 6.49" W x 1.41" H

mm | 165 mm W x 36 mm H

CAPACITY:

3 oz.

90 cc

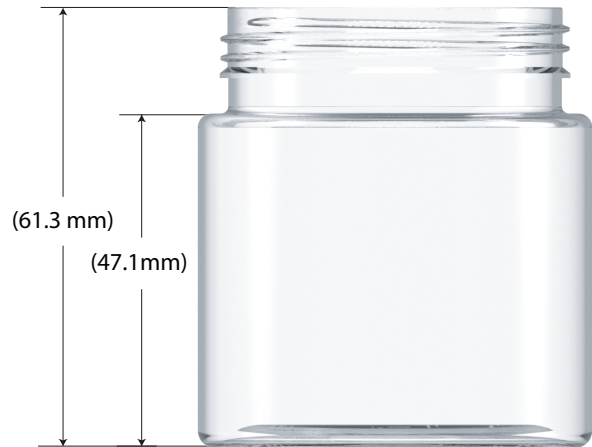

SPIRAL CONTAINER

CGSC1-3OZ

Label guide →

Please note that the label template may not be to scale. For accurate sizing and verification, refer to the dimension specifications. The provided label guides are for suggestion purposes only, and labels can be adjusted as needed.



SPIRAL CONTAINER

SKU: CGSC1-3OZ

LABEL SIZE SUGGESTION:

inch | 6.49" W x 1.41" H

mm | 165 mm W x 36 mm H

CAPACITY:

3 oz.

90 cc

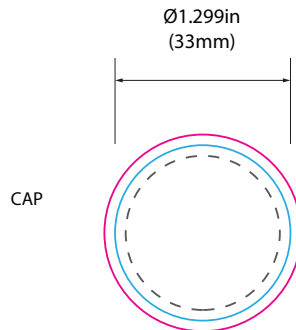
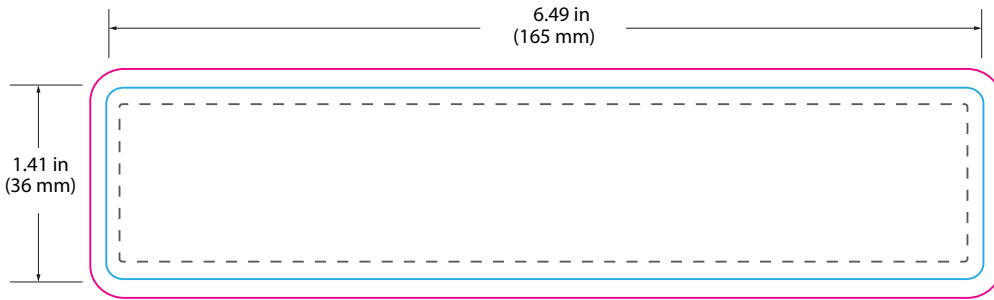
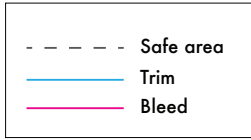

SPIRAL CONTAINER

CGSC1-3OZ

3 oz.

Please note that the label template may not be to scale. For accurate sizing and verification, refer to the dimension specifications. The provided label guides are for suggestion purposes only, and labels can be adjusted as needed.



SPIRAL CONTAINER

SKU: CGSC1-4OZ

LABEL SIZE SUGGESTION:

inch | 6.49" W x 1.77" H

mm | 165 mm W x 45 mm H

CAPACITY:

4 oz.

120 cc

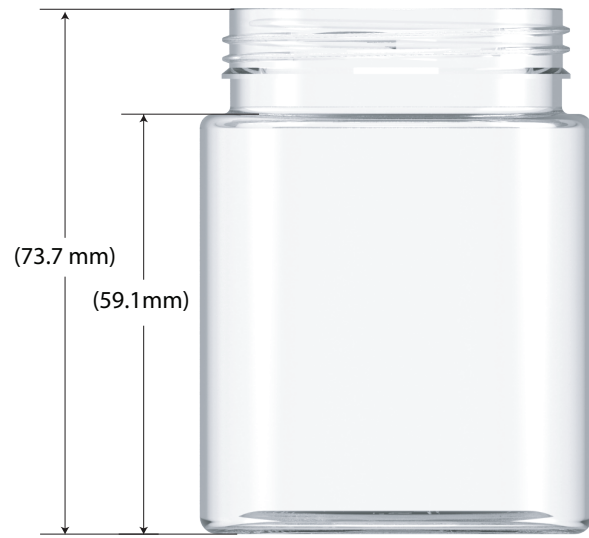

SPIRAL CONTAINER

CGSC1-4OZ

Label guide →

Please note that the label template may not be to scale. For accurate sizing and verification, refer to the dimension specifications. The provided label guides are for suggestion purposes only, and labels can be adjusted as needed.



SPIRAL CONTAINER

SKU: CGSC1-4OZ

LABEL SIZE SUGGESTION: **inch** | 6.49" W x 1.77" H **mm** | 165 mm W x 45 mm H

CAPACITY: 4 oz. 120 cc

--- Safe area
— Trim
— Bleed

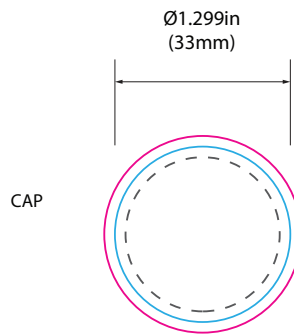
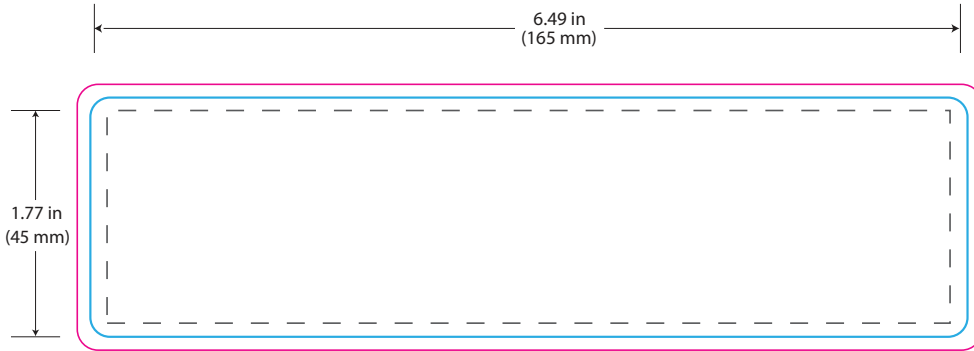



SPIRAL CONTAINER

SKU: CGSC1-5OZ

LABEL SIZE SUGGESTION:

inch | 6.49" W x 2.36" H

mm | 165 mm W x 60 mm H

CAPACITY:

5 oz.

150 cc



SPIRAL CONTAINER

CGSC1-5OZ

Label guide →

Please note that the label template may not be to scale. For accurate sizing and verification, refer to the dimension specifications. The provided label guides are for suggestion purposes only, and labels can be adjusted as needed.

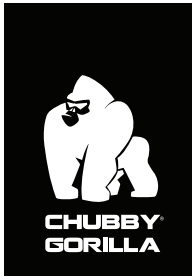

SPIRAL CONTAINER

SKU: CGSC1-5OZ

LABEL SIZE SUGGESTION: **inch** | 6.49" W x 2.36" H **mm** | 165 mm W x 60 mm H

CAPACITY: 5 oz. 150 cc

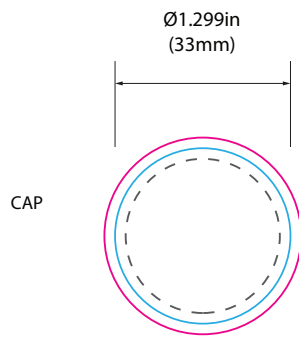
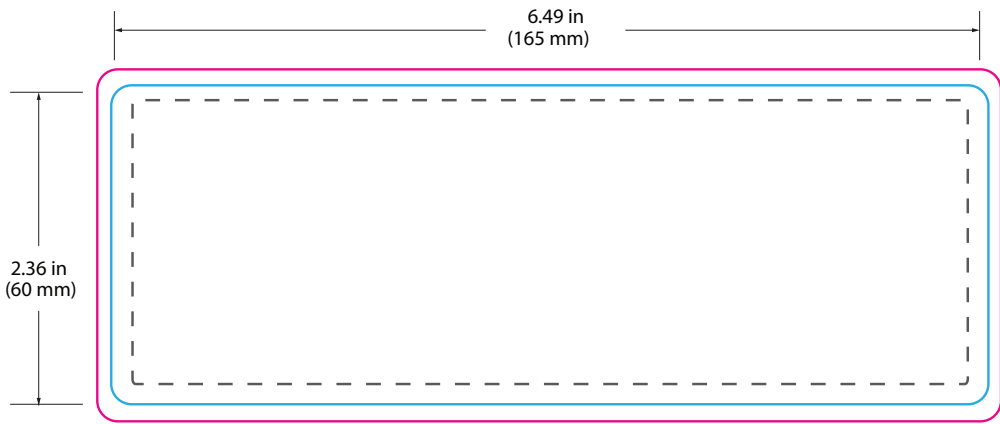
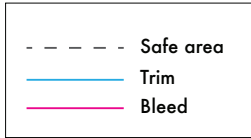

SPIRAL CONTAINER

CGSC1-5OZ

5 oz.

Please note that the label template may not be to scale. For accurate sizing and verification, refer to the dimension specifications. The provided label guides are for suggestion purposes only, and labels can be adjusted as needed.

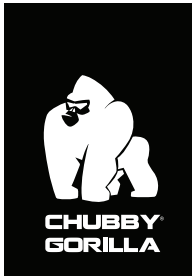

SPIRAL CONTAINER

SKU: CGSC1-6OZ

LABEL SIZE SUGGESTION:

inch | 6.49" W x 2.75" H

mm | 165 mm W x 70 mm H

CAPACITY:

6 oz.

180 cc

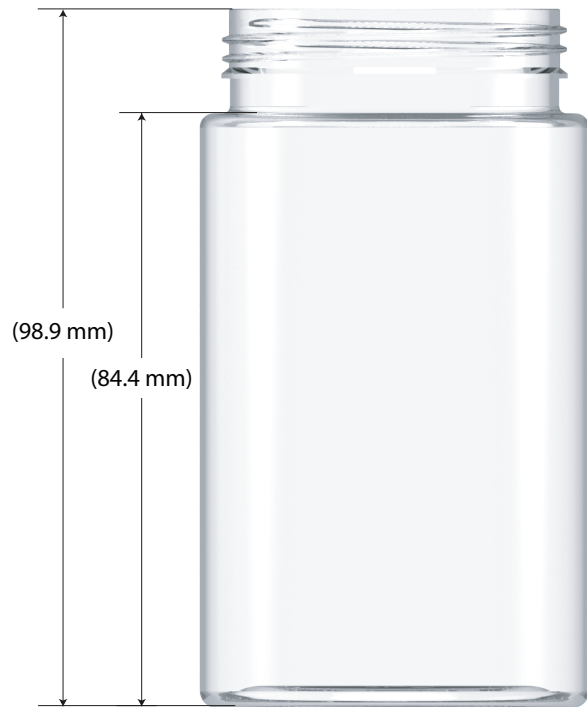

SPIRAL CONTAINER

CGSC1-6OZ

Label guide →

Please note that the label template may not be to scale. For accurate sizing and verification, refer to the dimension specifications. The provided label guides are for suggestion purposes only, and labels can be adjusted as needed.

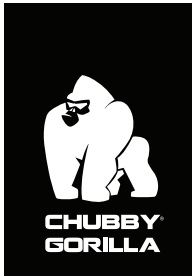

SPIRAL CONTAINER

SKU: CGSC1-6OZ

LABEL SIZE SUGGESTION: **inch** | 6.49" W x 2.75" H **mm** | 165 mm W x 70 mm H

CAPACITY: 6 oz. 180 cc

- - - - -	Safe area
— (blue)	Trim
— (pink)	Bleed

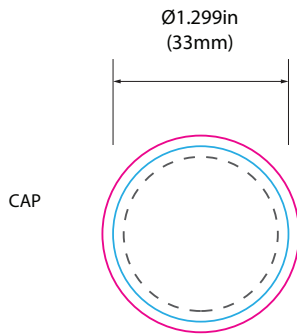
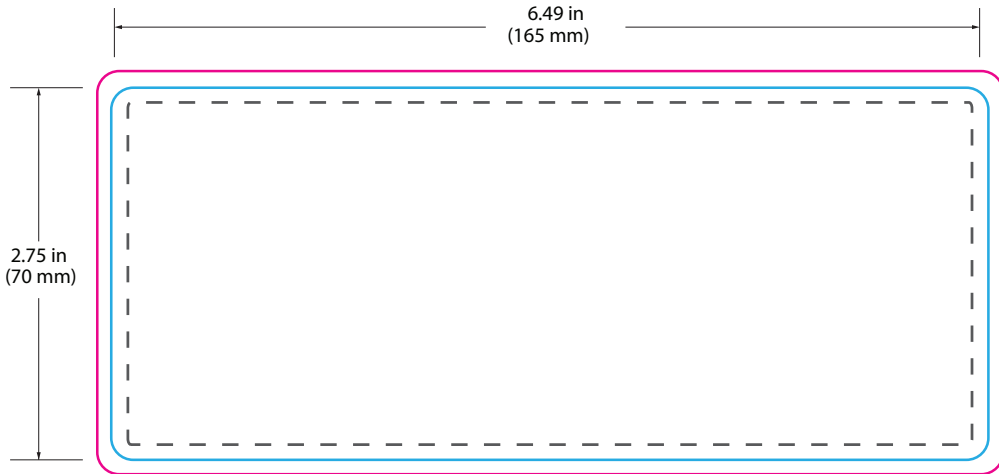

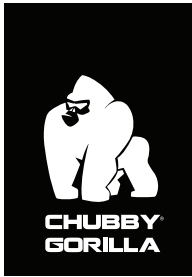

SPIRAL CONTAINER

SKU: CGSC1-8OZ

LABEL SIZE SUGGESTION:

inch | 6.49" W x 3.79" H

mm | 165 mm W x 96.5 mm H

CAPACITY:

8 oz.

240 cc



SPIRAL CONTAINER

CGSC1-8OZ

Label guide →

Please note that the label template may not be to scale. For accurate sizing and verification, refer to the dimension specifications. The provided label guides are for suggestion purposes only, and labels can be adjusted as needed.



SPIRAL CONTAINER

SKU: CGSC1-8OZ

LABEL SIZE SUGGESTION: **inch** | 6.49" W x 3.79" H **mm** | 165 mm W x 96.5 mm H

CAPACITY: 8 oz. 240 cc

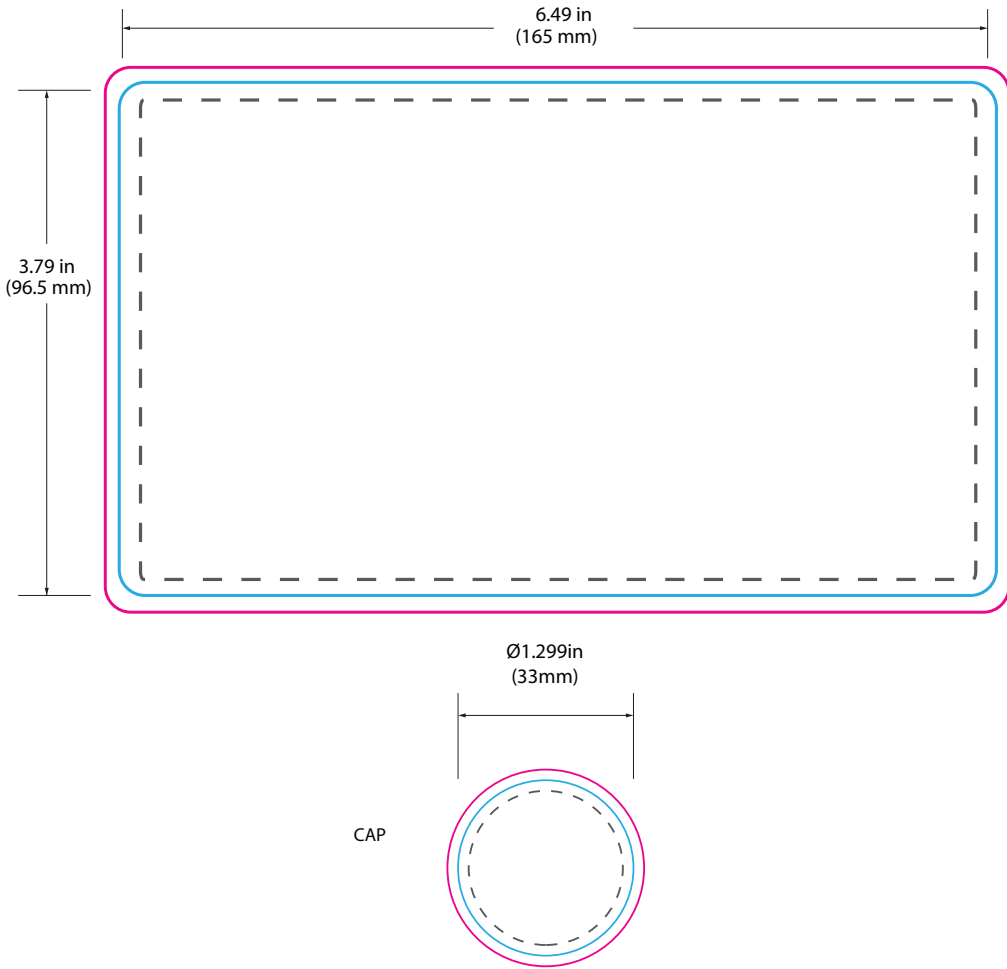
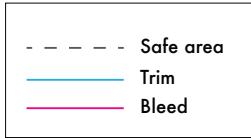

SPIRAL CONTAINER

CGSC1-8OZ

8 oz.

Please note that the label template may not be to scale. For accurate sizing and verification, refer to the dimension specifications. The provided label guides are for suggestion purposes only, and labels can be adjusted as needed.

SPIRAL XL CONTAINERS



SPIRAL XL CONTAINER

SKU: CGSC1-7.5OZXL

LABEL SIZE SUGGESTION:

inch | 11.2" W x 1.00" H

mm | 285 mm W x 25 mm H

CAPACITY:

7.5 oz.

220 cc

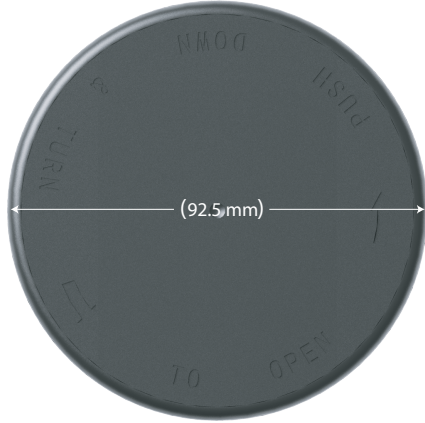

SPIRAL XL CONTAINER

CGSC1-7.5OZXL

Label guide →

Please note that the label template may not be to scale. For accurate sizing and verification, refer to the dimension specifications. The provided label guides are for suggestion purposes only, and labels can be adjusted as needed.



SPIRAL XL CONTAINER

SKU: CGSC1-7.5OZXL

LABEL SIZE SUGGESTION:

inch | 11.2" W x 1.00" H

mm | 285 mm W x 25 mm H

CAPACITY:

7.5 oz.

220 cc

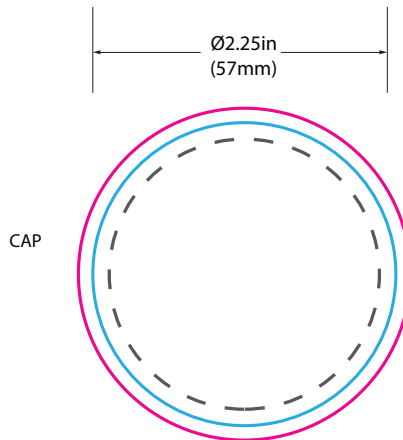
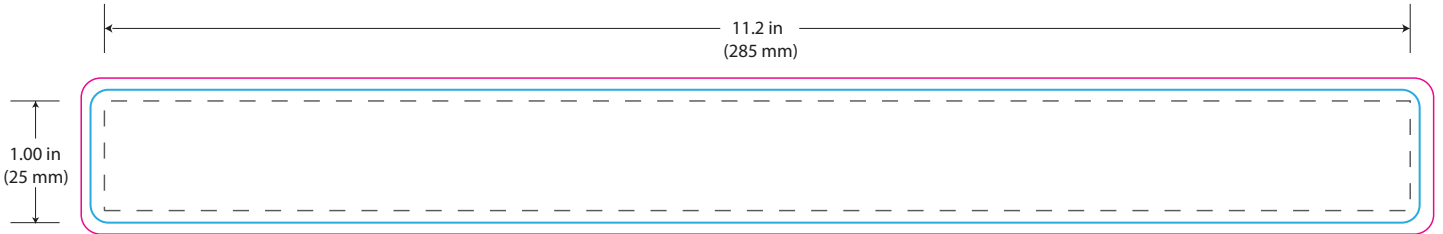
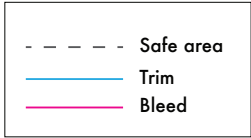

SPIRAL XL CONTAINER

CGSC1-7.5OZXL

7.5 oz.

Please note that the label template may not be to scale. For accurate sizing and verification, refer to the dimension specifications. The provided label guides are for suggestion purposes only, and labels can be adjusted as needed.

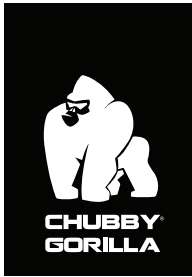

SPIRAL XL CONTAINER

SKU: CGSC1-10OZXL

LABEL SIZE SUGGESTION:

inch | 11.2" W x 1.38" H

mm | 285 mm W x 35 mm H

CAPACITY:

10 oz.

300 cc

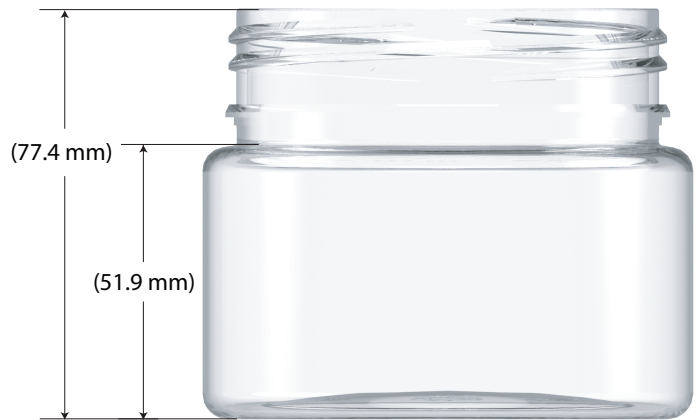
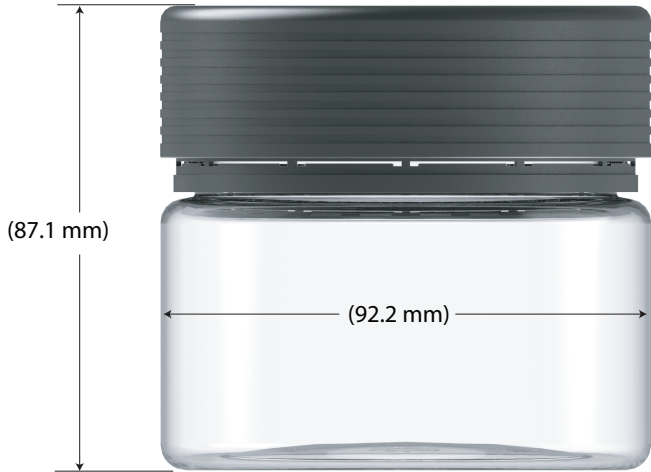

SPIRAL XL CONTAINER

CGSC1-10OZXL

Label guide →

Please note that the label template may not be to scale. For accurate sizing and verification, refer to the dimension specifications. The provided label guides are for suggestion purposes only, and labels can be adjusted as needed.



SPIRAL XL CONTAINER

SKU: CGSC1-10OZXL

LABEL SIZE SUGGESTION:

inch | 11.2" W x 1.38" H

mm | 285 mm W x 35 mm H

CAPACITY:

10 oz.

300 cc

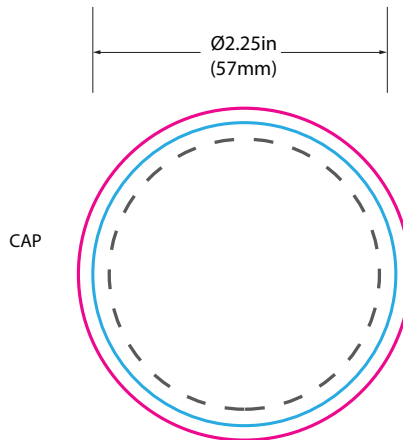
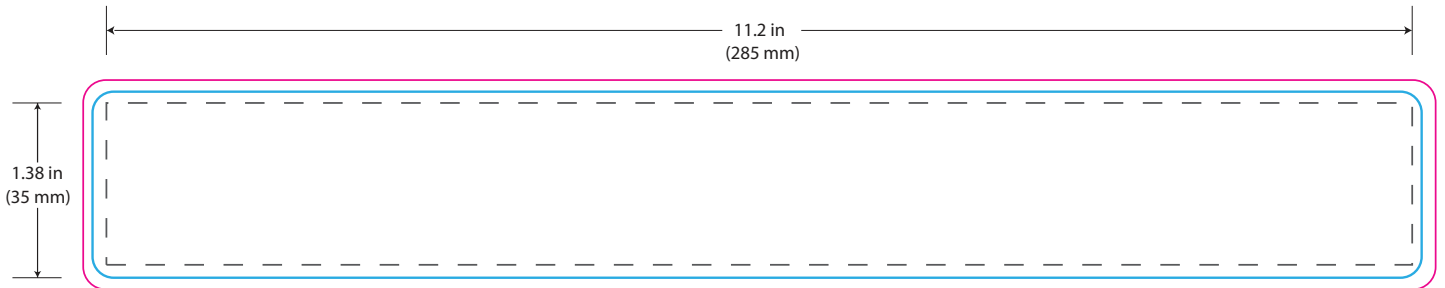
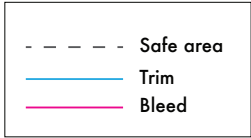

SPIRAL XL CONTAINER

CGSC1-10OZXL

10 oz.

Please note that the label template may not be to scale. For accurate sizing and verification, refer to the dimension specifications. The provided label guides are for suggestion purposes only, and labels can be adjusted as needed.

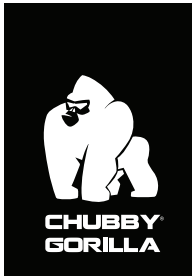

SPIRAL XL CONTAINER

SKU: CGSC1-18.5OZXL

LABEL SIZE SUGGESTION:

inch | 11.2" W x 3.00" H

mm | 285 mm W x 76 mm H

CAPACITY:

18.5 oz.

550 cc

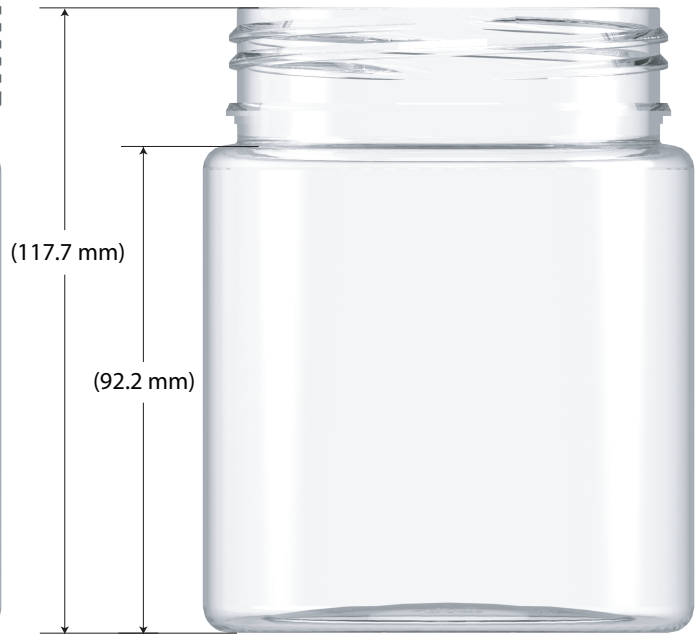

SPIRAL XL CONTAINER

CGSC1-18.5OZXL

Label guide →

Please note that the label template may not be to scale. For accurate sizing and verification, refer to the dimension specifications. The provided label guides are for suggestion purposes only, and labels can be adjusted as needed.



SPIRAL XL CONTAINER

SKU: CGSC1-18.5OZXL

LABEL SIZE SUGGESTION:

inch | 11.2" W x 3.00" H

mm | 285 mm W x 76 mm H

CAPACITY:

18.5 oz.

550 cc

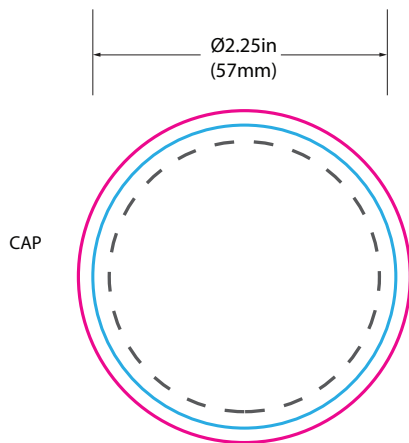
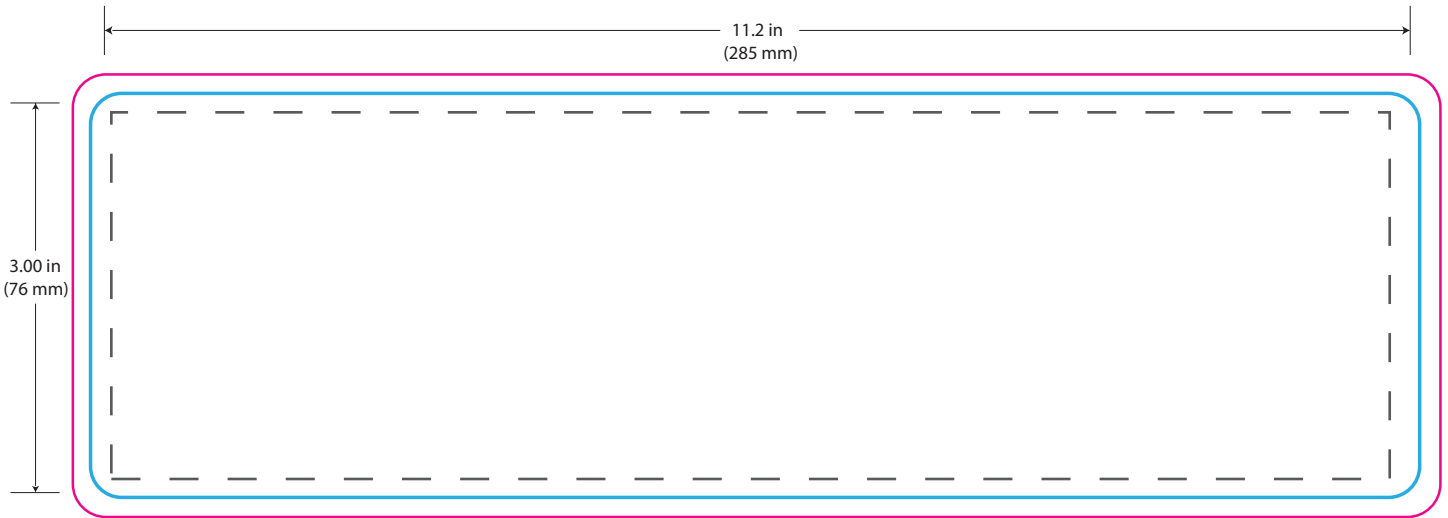
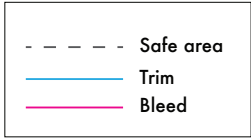

SPIRAL XL CONTAINER

CGSC1-18.5OZXL

18.5 oz.

Please note that the label template may not be to scale. For accurate sizing and verification, refer to the dimension specifications. The provided label guides are for suggestion purposes only, and labels can be adjusted as needed.



SPIRAL XL CONTAINER

SKU: CGSC1-21.5OZXL

LABEL SIZE SUGGESTION:

inch | 11.2" W x 3.38" H

mm | 285 mm W x 86 mm H

CAPACITY:

21.5 oz.

625 cc

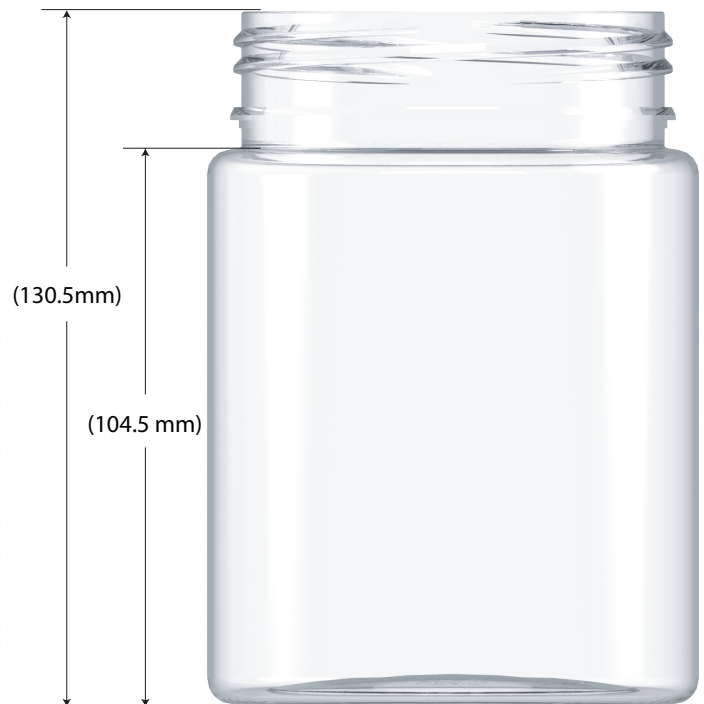

SPIRAL XL CONTAINER

CGSC1-21.5OZXL

Label guide →

Please note that the label template may not be to scale. For accurate sizing and verification, refer to the dimension specifications. The provided label guides are for suggestion purposes only, and labels can be adjusted as needed.



SPIRAL XL CONTAINER

SKU: CGSC1-21.5OZXL

LABEL SIZE SUGGESTION:

inch | 11.2" W x 3.38" H

mm | 285 mm W x 86 mm H

CAPACITY:

21.5 oz.

625 cc

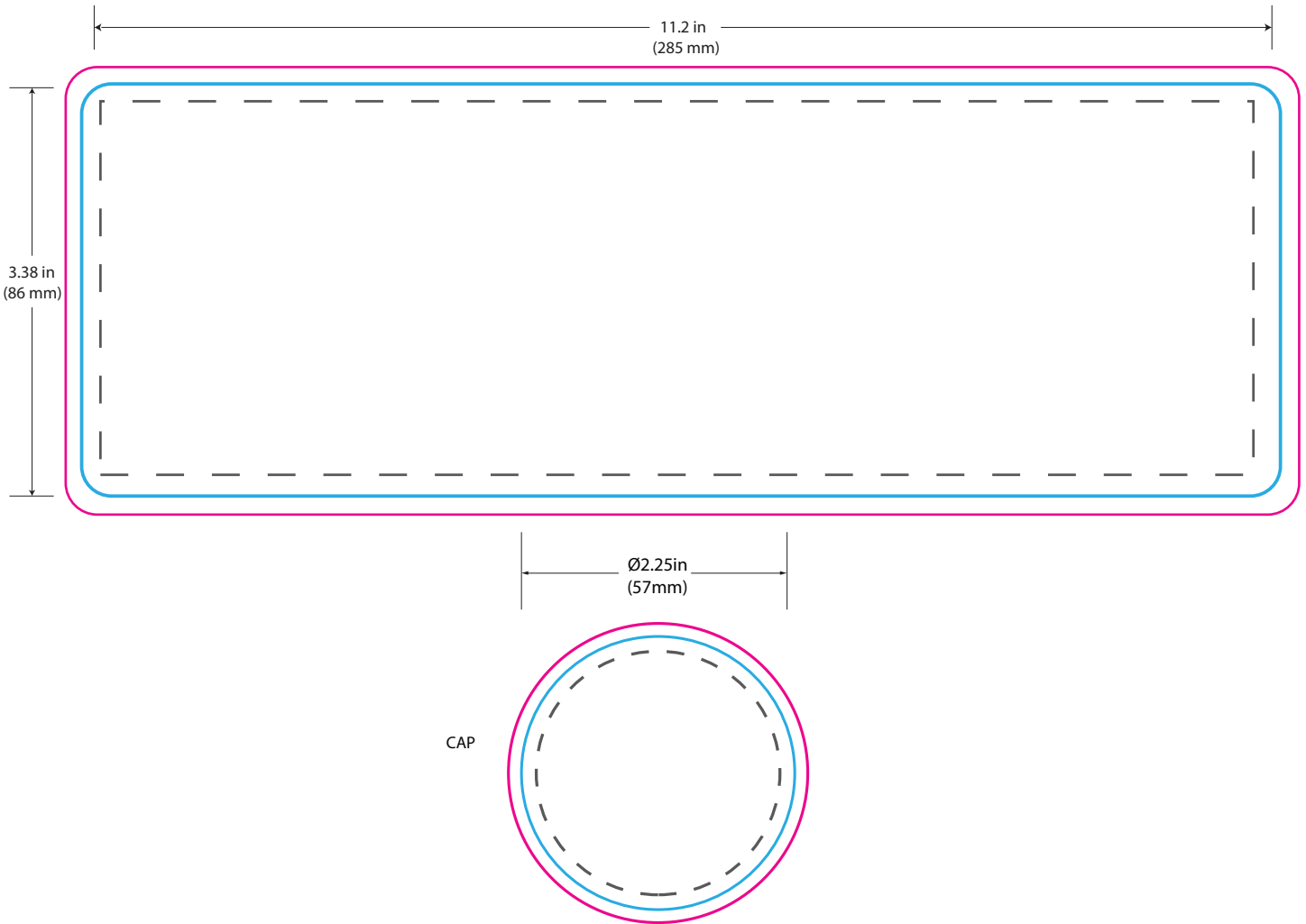
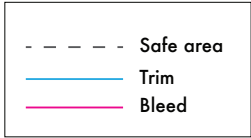

SPIRAL XL CONTAINER

CGSC1-21.5OZXL

21.5 oz.

Please note that the label template may not be to scale. For accurate sizing and verification, refer to the dimension specifications. The provided label guides are for suggestion purposes only, and labels can be adjusted as needed.

SPIRAL BOTTLES

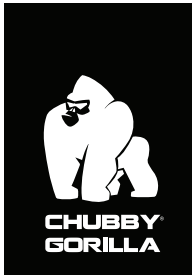

SPIRAL BOTTLE

SKU: CGSB1-60MLM

LABEL SIZE SUGGESTION:

inch | 4.4" W x 1.9" H

mm | 117 mm W x 48 mm H

CAPACITY:

60 mL

2.03 oz.

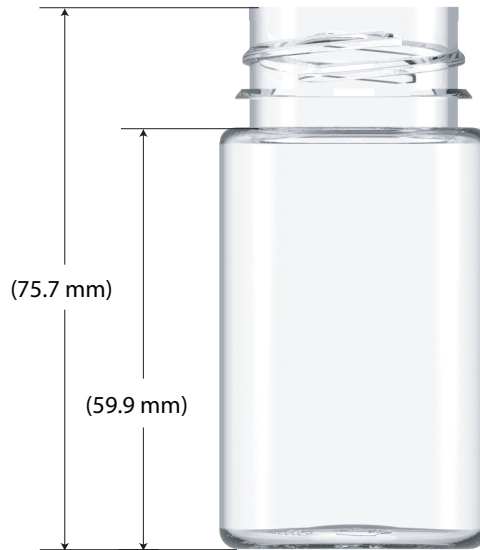

SPIRAL BOTTLE

CGSB1-60MLM

Label guide →

Please note that the label template may not be to scale. For accurate sizing and verification, refer to the dimension specifications. The provided label guides are for suggestion purposes only, and labels can be adjusted as needed.

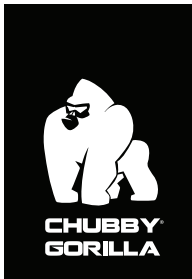

SPIRAL BOTTLE

SKU: CGSB1-60MLM

LABEL SIZE SUGGESTION: **inch** | 4.4" W x 1.9" H **mm** | 117 mm W x 48 mm H

CAPACITY: 60 mL 2.03 oz.

- - - - -	Safe area
—	Trim
—	Bleed

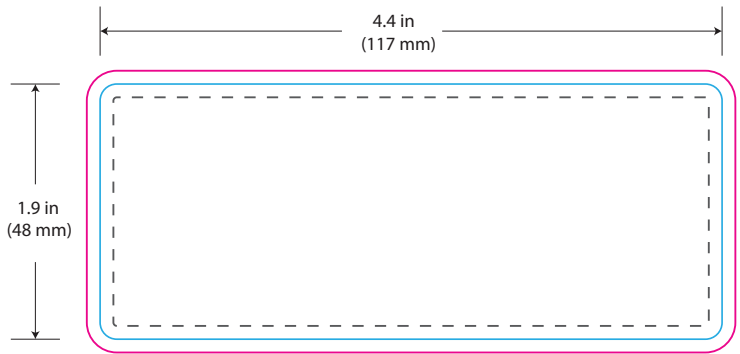

SPIRAL BOTTLE

CGSB1-60MLM

60 mL

Please note that the label template may not be to scale. For accurate sizing and verification, refer to the dimension specifications. The provided label guides are for suggestion purposes only, and labels can be adjusted as needed.

SPIRAL TUBES

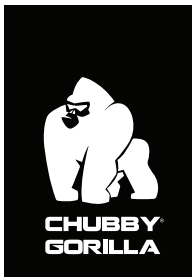

SPIRAL TUBE

SKU: CGST1-65MM

LABEL SIZE SUGGESTION: **inch** | 3.03" W x 2.04" H **mm** | 77 mm W x 52 mm H

CAPACITY: 13 mL 0.44 oz. 13 g



SPIRAL TUBE

CGST1-65MM

Label guide →

Please note that the label template may not be to scale. For accurate sizing and verification, refer to the dimension specifications. The provided label guides are for suggestion purposes only, and labels can be adjusted as needed.

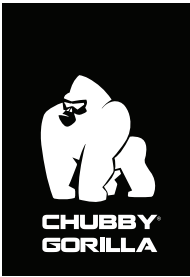

SPIRAL TUBE

SKU: CGST1-65MM

LABEL SIZE SUGGESTION: **inch** | 3.03" W x 2.04" H **mm** | 77 mm W x 52 mm H

CAPACITY: 13 mL 0.44 oz. 13 g

- - - - - Safe area
— Trim
— Bleed

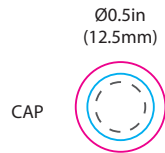
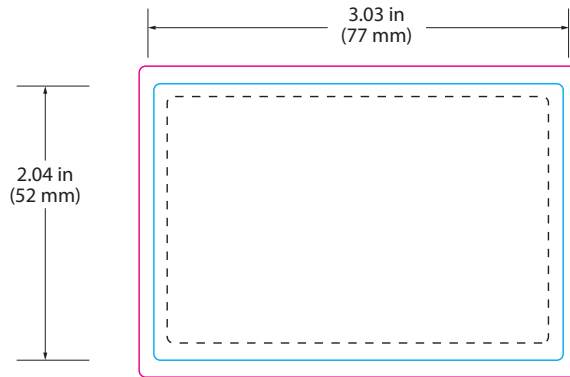

SPIRAL TUBE

CGST1-115MM

115 mm (length)

Please note that the label template may not be to scale. For accurate sizing and verification, refer to the dimension specifications. The provided label guides are for suggestion purposes only, and labels can be adjusted as needed.



SPIRAL TUBE

SKU: CGST1-95MM

LABEL SIZE SUGGESTION:

inch | 3.03" W x 3.23" H **mm** | 77 mm W x 82 mm H

CAPACITY:

19 mL 0.64 oz. 19 g

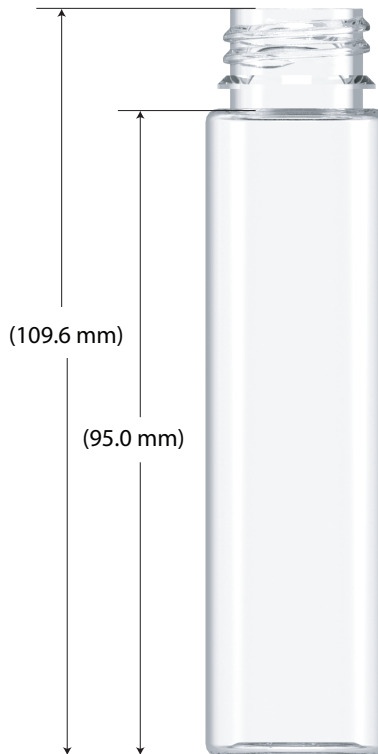
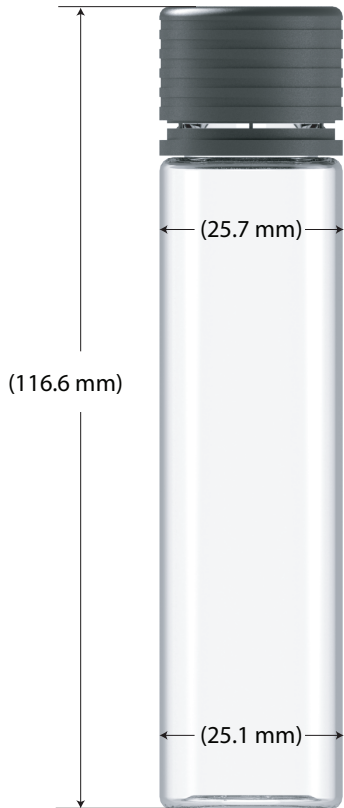

SPIRAL TUBE

CGST1-95MM

Label guide →

Please note that the label template may not be to scale. For accurate sizing and verification, refer to the dimension specifications. The provided label guides are for suggestion purposes only, and labels can be adjusted as needed.

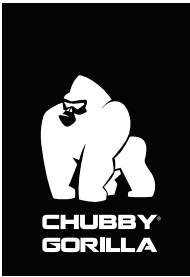

SPIRAL TUBE

SKU: CGST1-95MM

LABEL SIZE SUGGESTION: **inch** | 3.03" W x 3.23" H **mm** | 77 mm W x 82 mm H

CAPACITY: 19 mL 0.64 oz. 19 g

- - - - -	Safe area
—	Trim
—	Bleed

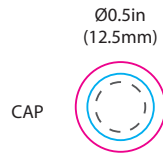
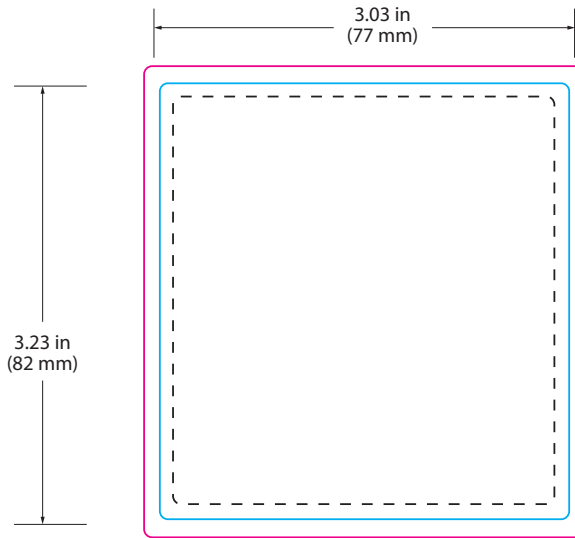

SPIRAL TUBE

CGST1-95MM

95 mm (length)

Please note that the label template may not be to scale. For accurate sizing and verification, refer to the dimension specifications. The provided label guides are for suggestion purposes only, and labels can be adjusted as needed.



SPIRAL TUBE

SKU: CGST1-115MM

LABEL SIZE SUGGESTION:

inch | 3.03" W x 4.03" H

mm | 77 mm W x 102.5 mm H

CAPACITY:

23 mL

0.78 oz.

23 g

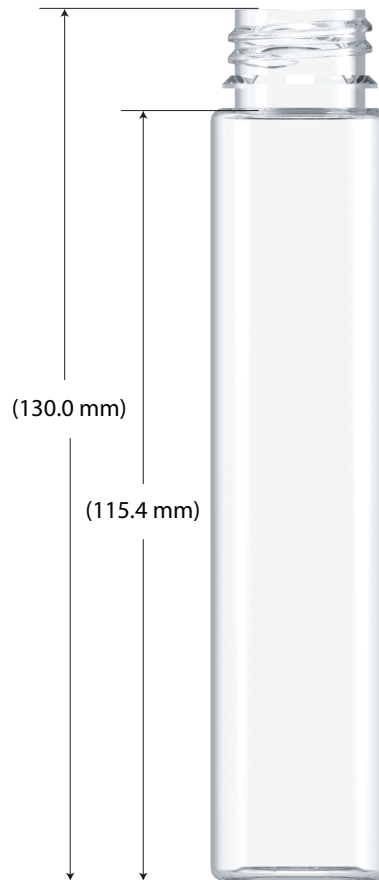
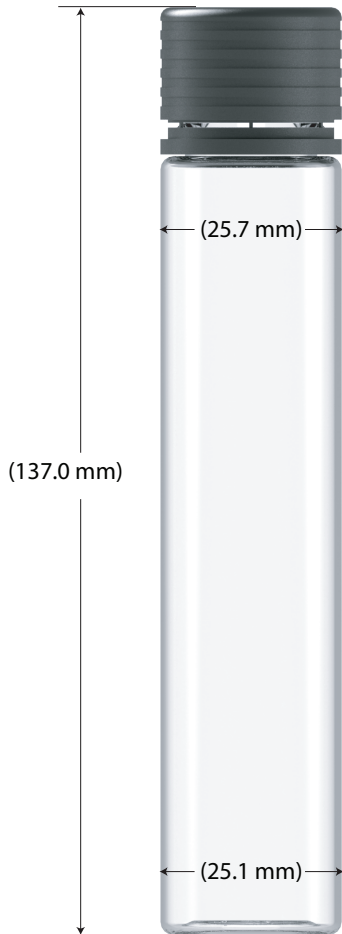

SPIRAL TUBE

CGST1-115MM

Label guide →

Please note that the label template may not be to scale. For accurate sizing and verification, refer to the dimension specifications. The provided label guides are for suggestion purposes only, and labels can be adjusted as needed.

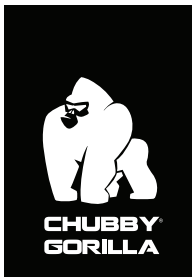

SPIRAL TUBE

SKU: CGST1-115MM

LABEL SIZE SUGGESTION: **inch** | 3.03" W x 4.03" H **mm** | 77 mm W x 102.5 mm H

CAPACITY: 23 mL 0.78 oz. 23 g

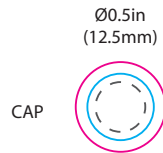
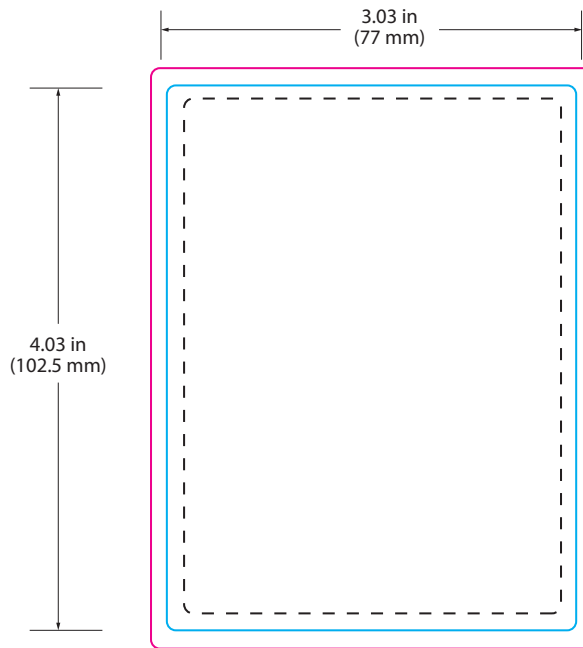
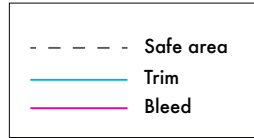

SPIRAL TUBE

CGST1-115MM

115 mm (length)

Please note that the label template may not be to scale. For accurate sizing and verification, refer to the dimension specifications. The provided label guides are for suggestion purposes only, and labels can be adjusted as needed.

SPIRAL 510 CARTRIDGE CONTAINER



SPIRAL 510 CARTRIDGE CONTAINER

SKU: CGSC1-510F

LABEL SIZE SUGGESTION: **inch** | 2.95" W x 2.17" H **mm** | 75 mm W x 55 mm H

CAPACITY: 65 mm

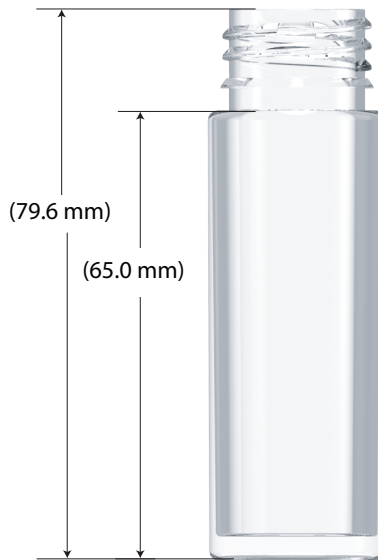

SPIRAL 510 CARTRIDGE CONTAINER

CGSC1-510F

Label guide →

Please note that the label template may not be to scale. For accurate sizing and verification, refer to the dimension specifications.
The provided label guides are for suggestion purposes only, and labels can be adjusted as needed.

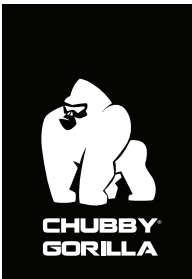

SPIRAL 510 CARTRIDGE CONTAINER

SKU: CGSC1-510F

LABEL SIZE SUGGESTION:

inch | 2.95" W x 2.17" H

mm | 75 mm W x 55 mm H

CAPACITY:

65 mm

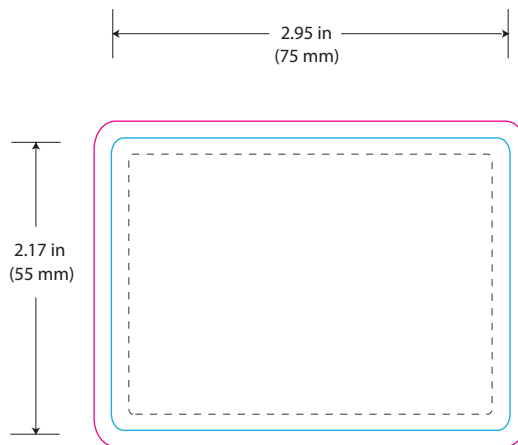

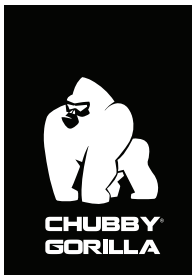

SPIRAL 510 CARTRIDGE CONTAINER

SKU: CGSC1-510R

LABEL SIZE SUGGESTION: **inch** | 2.95" W x 1.77" H **mm** | 75 mm W x 45 mm H

CAPACITY: 65 mm

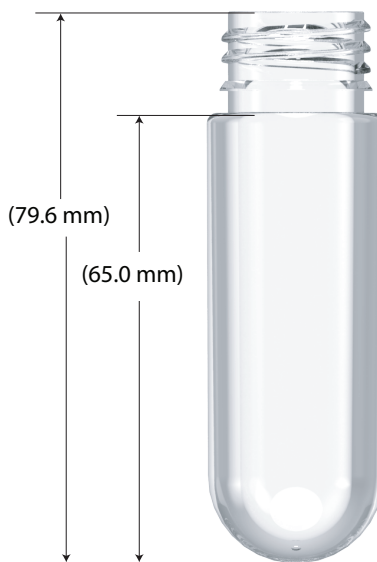
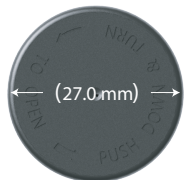

SPIRAL 510 CARTRIDGE CONTAINER

CGSC1-510R

Label guide

Please note that the label template may not be to scale. For accurate sizing and verification, refer to the dimension specifications. The provided label guides are for suggestion purposes only, and labels can be adjusted as needed.



SPIRAL 510 CARTRIDGE CONTAINER

SKU: CGSC1-510R

LABEL SIZE SUGGESTION: **inch** | 2.95" W x 1.77" H **mm** | 75 mm W x 45 mm H

CAPACITY: 65 mm

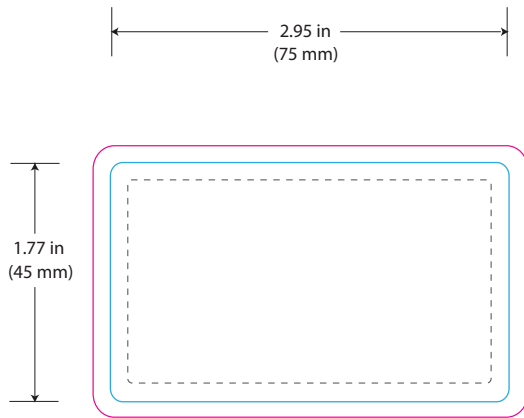
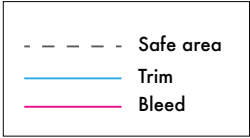

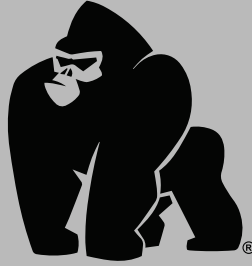

A SPECIALTY PACKAGING COMPANY

CHUBBY GORILLA® IS A SPECIALTY PACKAGING MANUFACTURER,
ENGINEERING SOLUTIONS FOR EMERGING INDUSTRIES ACROSS THE GLOBE.

GLOBAL HEADQUARTERS
CHUBBY GORILLA INC.,
4320 NORTH HARBOR BLVD,
FULLERTON, CA 92835, USA
+1 (844) 365-5218 | +1 (714) 253-3512

CHUBBY GORILLA EUROPE BV
SMITSPOL 4A
NIJCKERK, 3861 RS
NETHERLANDS
WWW.CHUBBYGORILLA.COM

DESIGNED IN ORANGE COUNTY, CALIFORNIA, U.S.A | © 2022 CHUBBY GORILLA INC. - ALL RIGHTS RESERVED

CHUBBY GORILLA, THE FIGURATIVE GORILLA LOGO AND OTHER MARKS ARE REGISTERED, PENDING OR UNREGISTERED TRADEMARKS AND/OR COPYRIGHTS OF CHUBBY GORILLA, INC. IN THE U.S. AND/OR OTHER COUNTRIES. THESE PRODUCTS MAY BE COVERED BY ONE OR MORE PATENTS OR PATENT APPLICATIONS, SEE WWW.CHUBBYGORILLA.COM/PATENTS

PRODUCT USE: MANY FACTORS BEYOND CHUBBY GORILLA'S ("CG") CONTROL AND UNIQUELY WITHIN USER'S KNOWLEDGE AND CONTROL CAN AFFECT THE USE AND PERFORMANCE OF A CG PRODUCT IN A PARTICULAR APPLICATION. GIVEN THE VARIETY OF FACTORS THAT CAN AFFECT THE USE AND PERFORMANCE OF A CG PRODUCT, USER IS SOLELY RESPONSIBLE FOR EVALUATING THE CG PRODUCT AND DETERMINING WHETHER IT IS FIT FOR A PARTICULAR PURPOSE AND SUITABLE FOR USER'S METHOD OF APPLICATION, INCLUDING BUT NOT LIMITED TO, DETERMINING WHETHER THE PRODUCT(S) PLACED WITHIN ITS PACKAGING SOLUTIONS ARE COMPATIBLE WITH EACH PARTICULAR PACKAGING SOLUTION.

WARRANTY, LIMITED REMEDY, AND DISCLAIMER: UNLESS AN ADDITIONAL WARRANTY IS SPECIFICALLY STATED ON THE APPLICABLE CG PRODUCT PACKAGING OR PRODUCT LITERATURE, CG WARRANTS THAT EACH CG PRODUCT MEETS THE APPLICABLE CG PRODUCT SPECIFICATION AT THE TIME CG SHIPS THE PRODUCT. CHUBBY GORILLA MAKES NO OTHER WARRANTIES OR CONDITIONS, EXPRESS OR IMPLIED, INCLUDING, BUT NOT LIMITED TO, ANY IMPLIED WARRANTY OR CONDITION OF MERCHANTABILITY OR FITNESS FOR A PARTICULAR PURPOSE OR ANY IMPLIED WARRANTY OR CONDITION ARISING OUT OF A COURSE OF DEALING, CUSTOM OR USAGE OF TRADE. IF THE CG PRODUCT DOES NOT CONFORM TO THIS WARRANTY, THEN THE SOLE AND EXCLUSIVE REMEDY IS, AT CG'S OPTION, REPLACEMENT OF THE CG PRODUCT OR REFUND OF THE PURCHASE PRICE.

LIMITATION OF LIABILITY: EXCEPT WHERE PROHIBITED BY LAW, CG WILL NOT BE LIABLE FOR ANY LOSS OR DAMAGE ARISING FROM THE CG PRODUCT, WHETHER DIRECT, INDIRECT, SPECIAL, INCIDENTAL OR CONSEQUENTIAL, REGARDLESS OF THE LEGAL THEORY ASSERTED, INCLUDING WARRANTY, CONTRACT, NEGLIGENCE OR STRICT LIABILITY.