



PATIO COVER

Installation Guide.

Before Beginning Installation, Read Each Step Carefully

Bolts, Nuts & Screws

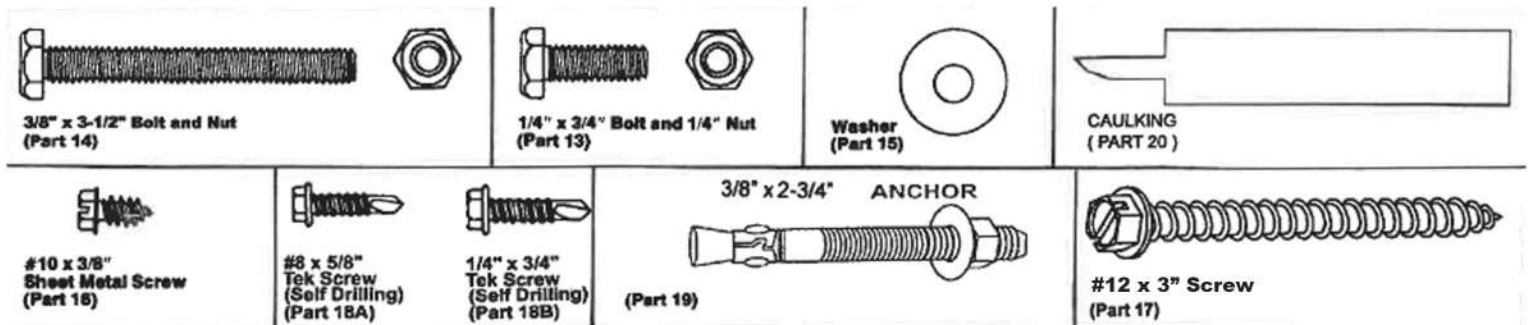

Components and Assembly Instructions

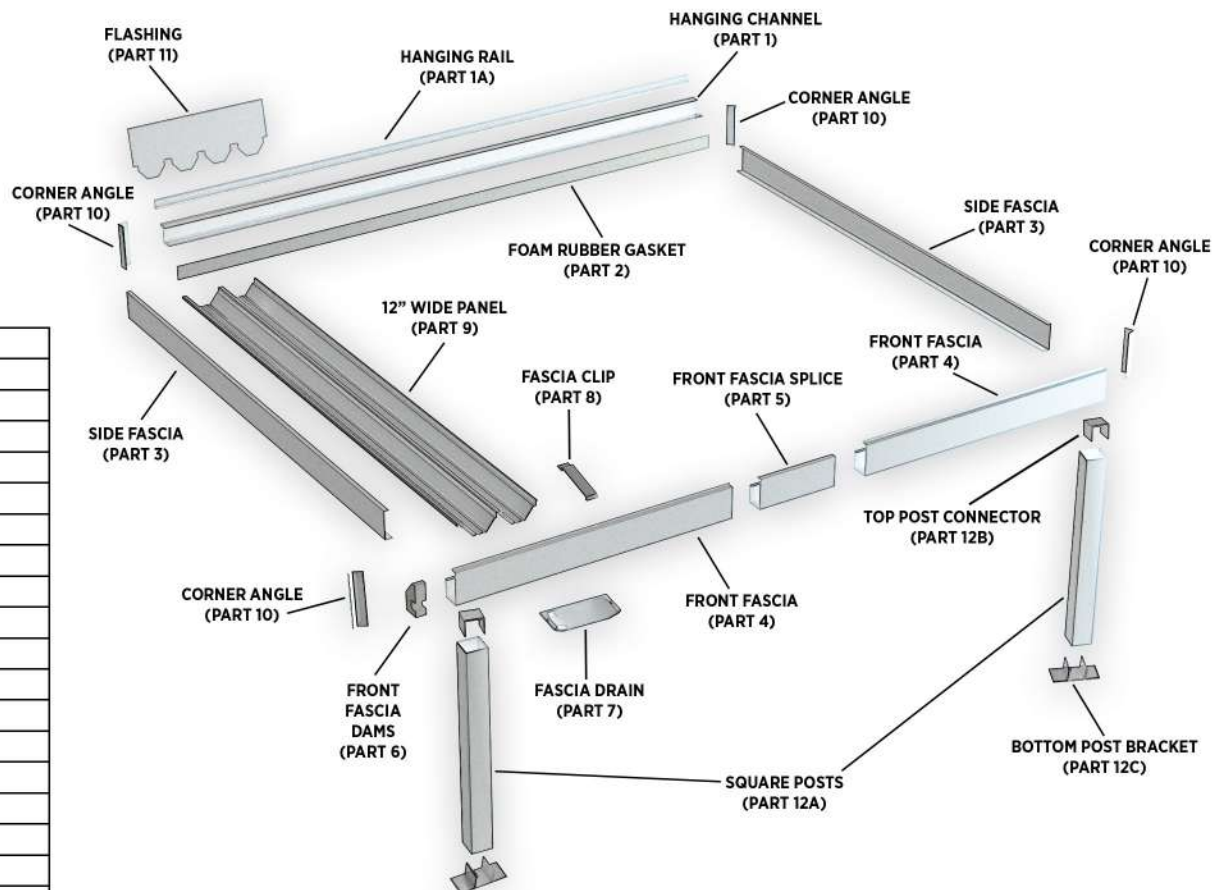

Part #	Description
1	Hanging Channel
1A	Hanging Rail
2	Foam Rubber Gasket
3	Side Fascia
4	Front Fascia
5	Front Fascia Splice
6	Front Fascia Dams
7	Fascia Drain
8	Fascia Clip
9	12" Wide Panel
10	Corner Angle
11	Flashing
12A	Square Post
12B	Top Post Connector
12C	Bottom Post Bracket
13	1/4" x 3/4" Bolt and Nut
14	3/8" x 3-1/2" Bolt and Nut
15	1/4" x 3/4" Washer
16	#10 x 3/8" Screw
17	#12 x 3" Screw
18A	#8 x 5/8" Tek Screw (Self Drilling)
18B	1/4" x 3/4" Tek Screw (Self Drilling)
19	3/8" x 2-3/4" Anchor
20	Caulking



STEP 01 - A

Preparing the FRONT FASCIA & HANGING CHANNEL

Lay the hanging channel and front fascia parallel and evenly on a flat non-abrasive surface. Make sure both front fascia and hanging channel rails remain even. Tape both ends together.

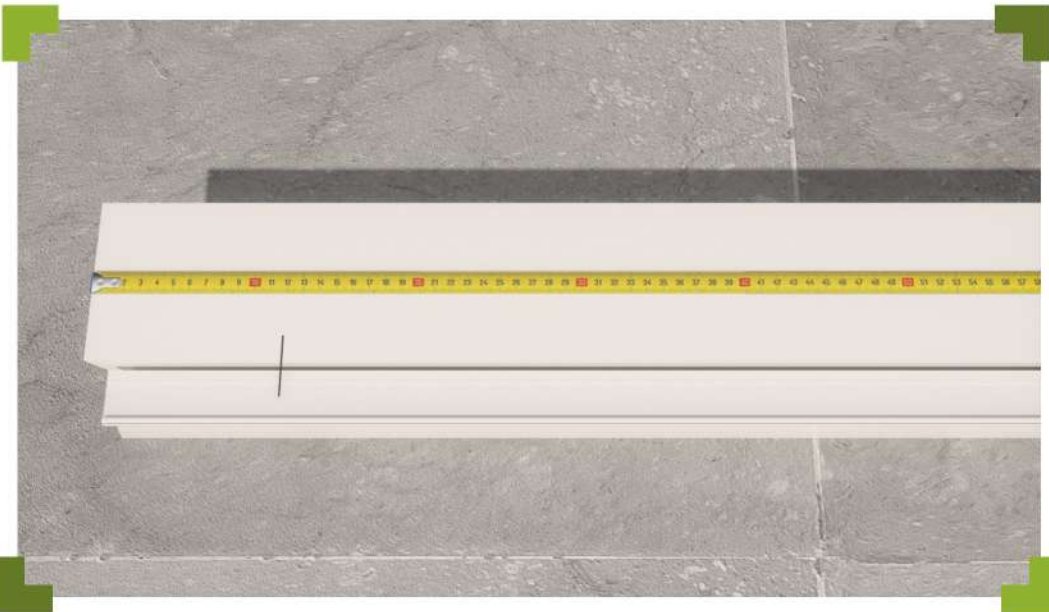

STEP 01 - B

Preparing the FRONT FASCIA & HANGING CHANNEL

Hook tape on end and make the first mark on FRONT FASCIA & HANGING CHANNEL 12-3/8" from the end. Then move the measuring tape to that first mark and proceed to mark every 12" with a pencil.

*These will be the center marks of the MATED roof panels.

**DO NOT CUT the FRONT FASCIA or HANGING CHANNEL.



STEP 02 - A
Setting the HANGING RAIL & HANGING CHANNEL

Determine if mounting to house wall or to house fascia board.

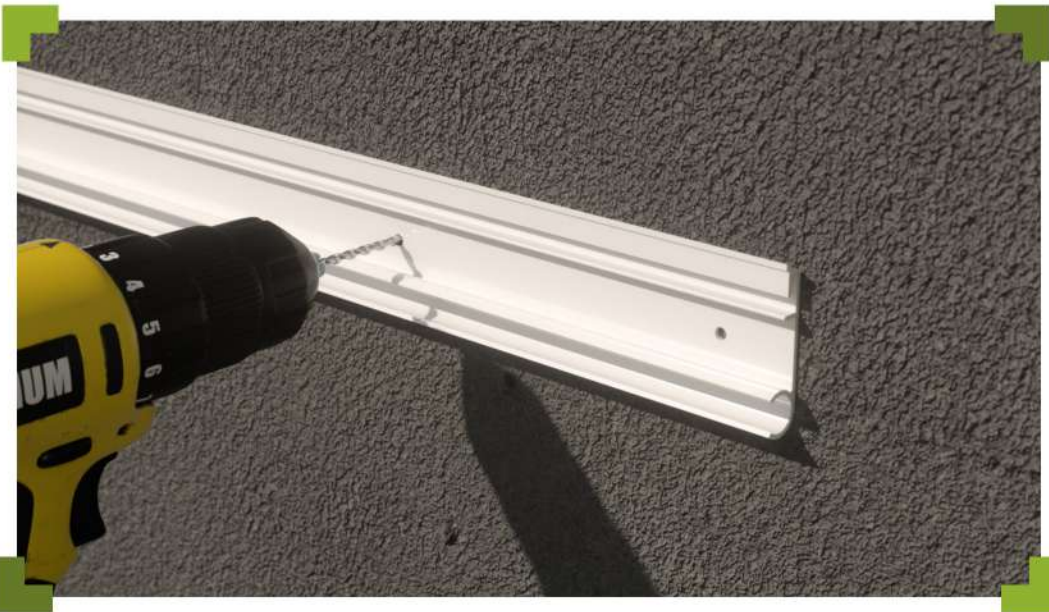

STEP 02 - B
Setting the HANGING RAIL & HANGING CHANNEL

If mounting OPTION 1:

Mark the locations of the wall studs on the wall.

If mounting OPTION 2:

Mark the location of the roof rafter truss ends to fascia board.



STEP 02 - C

Setting the HANGING RAIL & HANGING CHANNEL

Pre-drill 3 holes in the HANGING RAIL using a 3/16" drill bit. 2 inches from each end and one in the center.
Fasten the hanging rail using the #12 x 3" wood screws keeping it level.
Now mark the location of the wall studs or roof rafter truss ends onto the hanging rail.



STEP 02 - C

Setting the HANGING RAIL & HANGING CHANNEL

Pre-drill the 3/16" holes and fasten rail using the #12 x 3" wood screws.



STEP 02 - D

Setting the HANGING RAIL & HANGING CHANNEL

If hanging rail is spliced use the HANGING RAIL SPLICE. Fasten with two #8 tek screws each side into the HANGING RAIL.

Caulk up and down the seam joint but not into the bottom open female groove.

Slide hanging channel into the hanging rail. Caulk all screw heads in hanging rail.



STEP 02 - E

Setting the HANGING RAIL & HANGING CHANNEL

Run generous bead of sealant along the entire length of hanging rail.

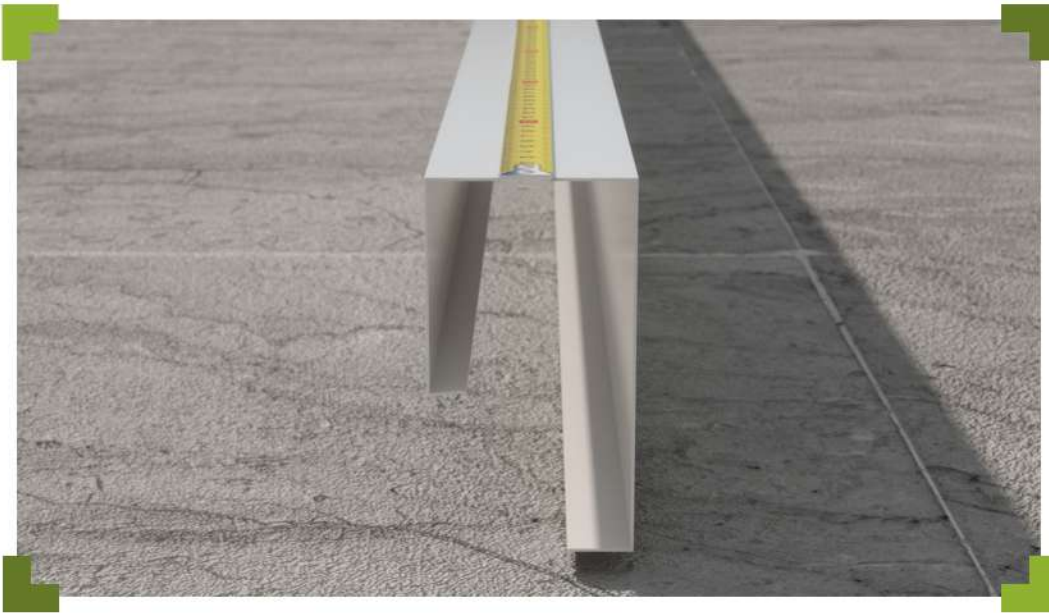

STEP 03 - A
Preparing the FRONT FASCIA

Measure over 15" & 18" from each end for the top post bracket locations.

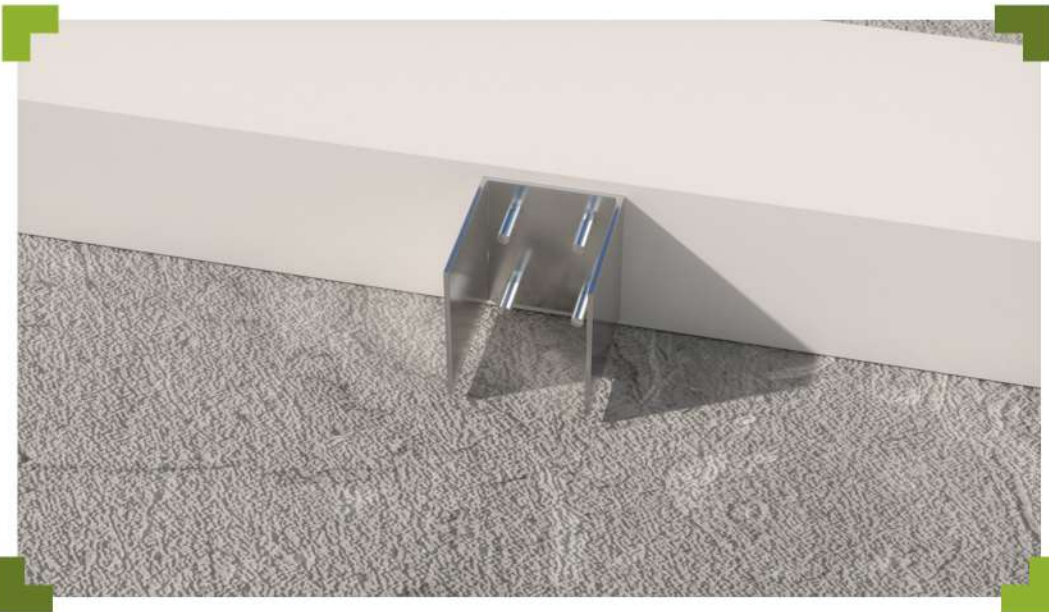

STEP 03 - B
Preparing the FRONT FASCIA

Mark equal spacings for remaining post(s) by dividing the entire space by number of openings.
E.g. 3 posts = 2 openings, 4 posts = 3 openings etc.
Trace around the TOP BASE onto the FRONT FASCIA bottom and re-check measurements.



STEP 03 - C
Preparing the FRONT FASCIA

If your TOP POST BASE does not have pre-drilled holes proceed to drill 4 holes 1/4" in the bottom of base.



STEP 03 - D
Preparing the FRONT FASCIA

Hold TOP POST BASE to the marked post locations on the bottom of FRONT FASCIA.
Mark the 4 hole locations & drill the four 1/4" holes.
Insert the bolts from inside the FRONT FASCIA downward through the TOP BASE POST.
Fasten with the washer and nut.

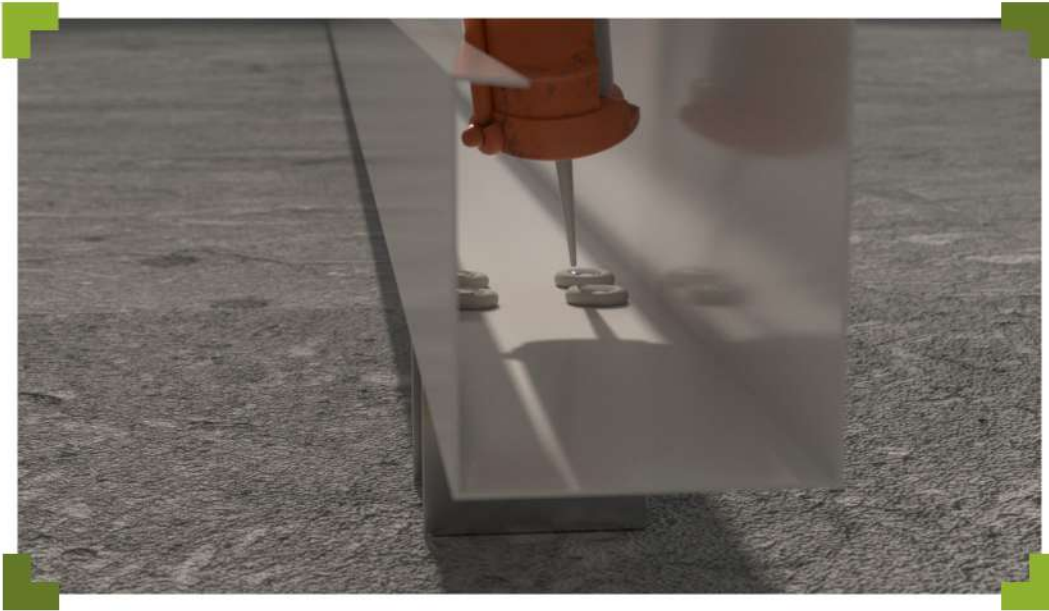

STEP 03 - E & F
Preparing the FRONT FASCIA

Turn over the FRONT FASCIA and set on the fastened post bases and caulk around every bolt head inside the FRONT FASCIA.

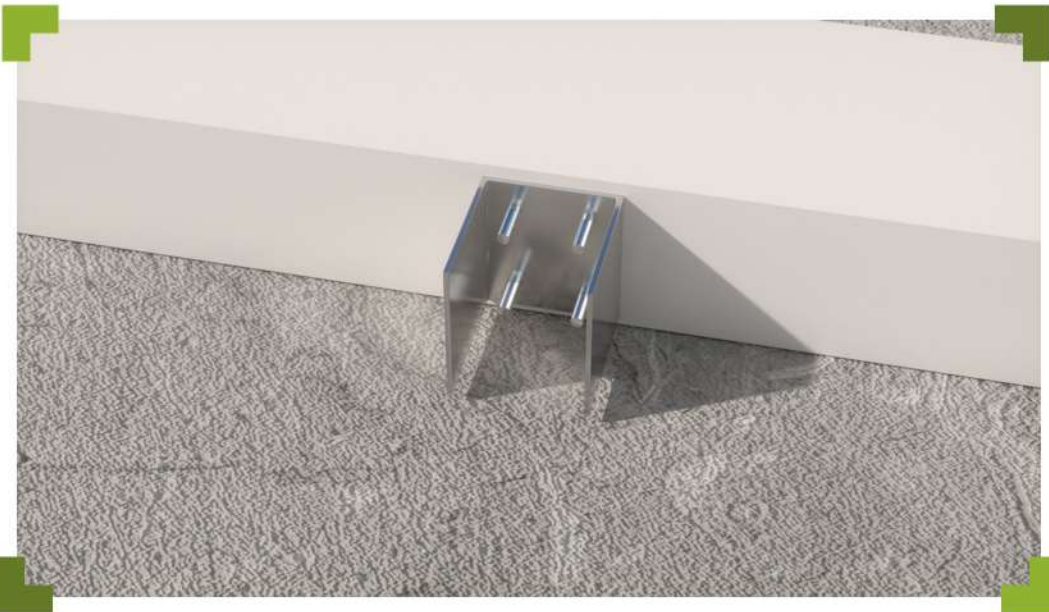

STEP 03 - E & F
Preparing the FRONT FASCIA

Set the FRONT FASCIA on the slab as shown.

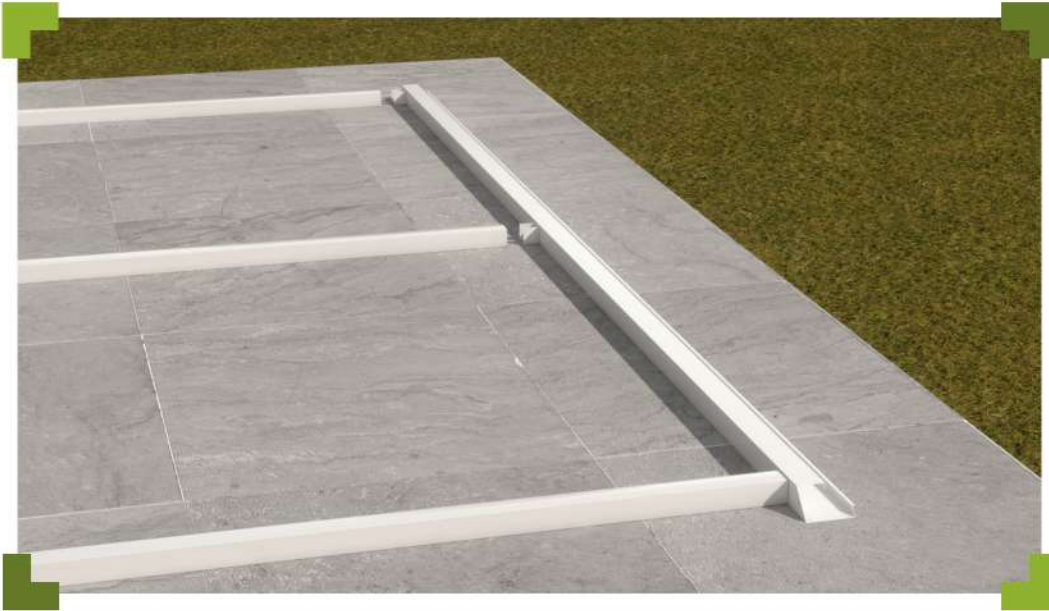

STEP 04 - A & B

Preparing and fastening POSTS to FRONT FASCIA

Place a level on front edge of the slab to determine which is the low end - the left side or the right side. After determining the low side, measure from slab up to the bottom of HANGING CHANNEL on that low side.

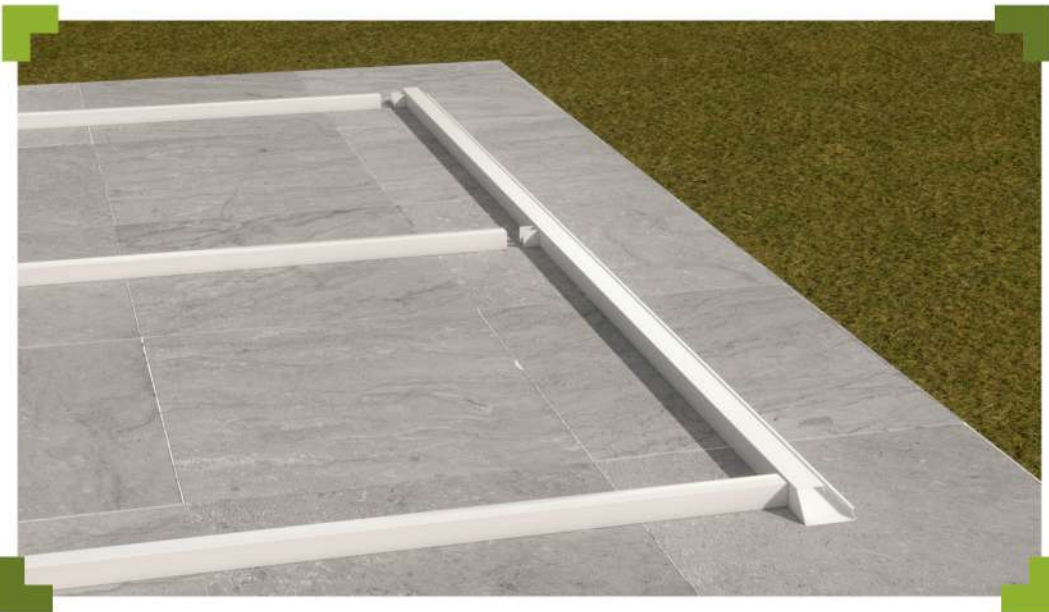

STEP 04 - C

Preparing and fastening POSTS to FRONT FASCIA

Then subtract 2 inches and subtract 1/2 inch per foot for the depth of your patio cover.

E.g. If you bought an 8ft deep x 14ft wide cover:

$8\text{ft} \times \frac{1}{2}'' = 4$ inches. So if you measured 98 inches to bottom of hanger you will subtract $98 - 2 = 96$, then $96 - 4 = 92$ inches for your first post length.



STEP 04 - D & E

Preparing and fastening POSTS to FRONT FASCIA

Cut the first POST, slip it over the TOP POST BASE on that LOW side.

Drill two 3/8" holes completely through the post and post base. Insert two 3/8" x 3-1/2" thru bolts and fasten. Insert the BOTTOM POST BASE into the bottom of the POST, drill two 3/8" holes through the post and bases and fasten using two 3-1/2" thru bolts.



STEP 04 - F

Preparing and fastening POSTS to FRONT FASCIA

Place a ladder at the first end post for person #1, place second ladder near the opposite end post for person #2. Stand up the attached post and front fascia assembly while person #2 is holding the front fascia level & holding a POST against the FRONT FASCIA.



STEP 04 - G & H

Preparing and fastening POSTS to FRONT FASCIA

Person #1 has level on FRONT FASCIA, telling person #2 to move it up or down to the LEVEL position, then person #2 marks the POST along the bottom of the FRONT FASCIA to be the cutting mark. Cut the post. Repeat steps D & E. Note: Cut the post short 1/4" below the pencil mark on the post to deduct for the bottom post bracket.



STEP 04 - I & J

Preparing and fastening POSTS to FRONT FASCIA

If your cover has more than 2 POSTS, stand up the post and FRONT FASCIA assembly, level the fascia, mark the additional post heights against the fascia bottom, cut posts and fasten by repeating steps D, E, G & H. All POST tops should be THRU bolted thru TOP POST BASE. All POST bottoms should be thru bolted through bottom post brackets.



STEP 05 - A
Setting first ROOF PANELS

Raise the FRONT FASCIA and POST assembly into position and temporarily stabilize the FRONT FASCIA & POST in upright position by tying each end post to each ladder with a rope or cord.

*DO NOT FASTEN post bottom to patio surface.



STEP 05 - B
Setting first ROOF PANELS

Check the FRONT FASCIA with 4' level across the width of patio cover (if adjustments are needed, remove a post and cut bottom to make level).



STEP 05 - C & D

Setting first ROOF PANELS

Make sure RIGHT end of FRONT FASCIA is square to the RIGHT end of the HANGING CHANNEL at the house. Slide the roof panel into the HANGING CHANNEL against the foam with “female” lock edge on the RIGHT. Keep panel even/flush to hanging channel on the RIGHT end and front fascia.



STEP 05 - E

Setting first ROOF PANELS

The pre-punched holes in the roof panel should be lined up with the screw groove in the bottom lip of HANGING CHANNEL. Use ONE #10 x 3/8” sms to fasten first section of roof panel to the HANGING CHANNEL as shown. DO NOT fasten the second section of the roof panel yet.



STEP 05 - F & G

Setting first ROOF PANELS

Fasten the first section ONLY of the roof panel to the FRONT FASCIA using one #8 tek screw.
Have the ROOF PANEL FLUSH with the top lip of the front of the FRONT FASCIA.
Use 4ft level to plumb/level the bottom of end post in both directions (front and side).
DO NOT anchor the post bottom yet.



STEP 05 - F & G

Setting first ROOF PANELS

Fasten the first section ONLY of the roof panel to the FRONT FASCIA using one #8 tek screw.
Have the ROOF PANEL FLUSH with the top lip of the front of the FRONT FASCIA.
Use 4ft level to plumb/level the bottom of end post in both directions (front and side).
DO NOT anchor the post bottom yet.



STEP 05 - H
Setting first ROOF PANELS

Take second roof panel, go to the LEFT END of HANGING CHANNEL. Slide the roof panel into the HANGING CHANNEL against the foam with “female” lock edge on the RIGHT. Keep the MALE edge even/flush to hanging channel and FRONT FASCIA on the LEFT END.



STEP 05 - H
Setting first ROOF PANELS

The pre-punched holes in the roof panel should be lined up with the screw groove in the bottom lip of HANGING CHANNEL.
Use ONE #10 x 3/8” sms to fasten first section of roof panel to the HANGING CHANNEL as shown in step 5E.



STEP 05 - I & J

Setting first ROOF PANELS

Fasten the last section **ONLY** of the roof panel to the **FRONT FASCIA** using one #8 tek screw.
Set the roof panel **EVEN/FLUSH** with the top leg of the **FRONT FASCIA** (see step F).
Use 4ft level to plumb the bottom of end post in both directions (front and side).
DO NOT anchor the post bottom yet.

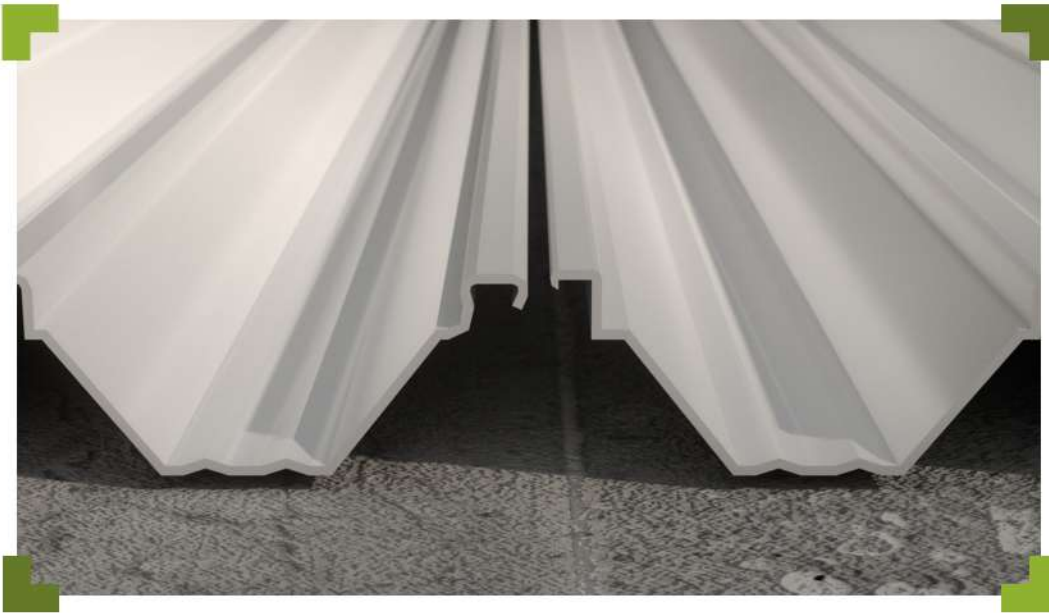

STEP 06 - A & B

Running the ROOF PANELS & PRE-FORMED FLASHING

Starting on the right end get a NEW roof panel, FEMALE lock on right side. Let this panel overhang a few inches OVER AND past the FRONT FASCIA.



STEP 06 - C

Running the ROOF PANELS & PRE-FORMED FLASHING

Set the FEMALE lock on top of the MALE lock of the first panel. Raise both panels upward where they touch slightly to make a V then lower them slowly to lock together. Check to make sure they locked together then slide the new panel into the hanging channel.



STEP 06 - D
Running the ROOF PANELS & PRE-FORMED FLASHING

IT IS IMPORTANT TO align the CENTER OF THE SEAMS of the overlapped/mated roof panels with the 12 inch marks made on the HANGING RAIL and FRONT FASCIA from step 1B before fastening roof panels.



STEP 06 - E & F
Running the ROOF PANELS & PRE-FORMED FLASHING

Slide roof panel into the HANGING CHANNEL foam and line up the holes with the screw groove in HANGING CHANNEL. Only fasten the RIGHT HALF SIDE OF NEW ROOF PANEL using one #10 x 3/8" sms into the HANGING CHANNEL screw groove and one #8 tek screw into the FRONT FASCIA.



STEP 06 - G, H & I

Running the ROOF PANELS & PRE-FORMED FLASHING

Fasten the third roof panel.



STEP 06 - G, H & I

Running the ROOF PANELS & PRE-FORMED FLASHING

Finish fastening the third roof panel into the HANGING CHANNEL.



STEP 06 - J

Running the ROOF PANELS & PRE-FORMED FLASHING

Now you have 3 roof panels started on the right side. Take one PRE-FORMED FLASHING hold the flashing upright so the 5/16 inch leg is aligned into the FLASHING GROOVE in the HANGING RAIL. Slowly lower the flashing down to the roof panel. Bend the tabs downward to go into the roof panel grooves to block leaves.



STEP 06 - K

Running the ROOF PANELS & PRE-FORMED FLASHING

Put a DAB of caulk sealant under the first NOTCH on the right where it rests on the roof panel. Fasten through the flashing into the roof panel top using one #8 tek screw. Then put another DAB of caulk over the screw head.

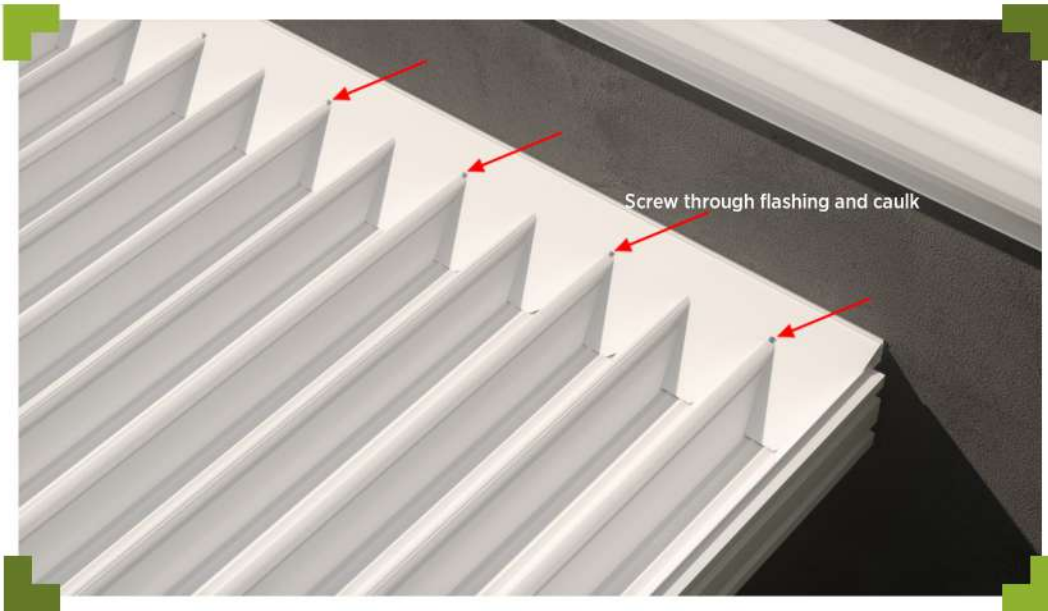

STEP 06 - L & M

Running the ROOF PANELS & PRE-FORMED FLASHING

After you run two more roof panels - having three roof panels exposed - run the next PRE-FORMED FLASHING repeating steps J & K. Be sure to caulk and fasten through both pieces of FLASHING where they overlap then fasten FLASHING through every other notch.

Run all the roof panels and pre-formed flashings.



STEP 07 - A
Anchoring the POSTS

Each post must be plumb/level in both directions. (Front and side)

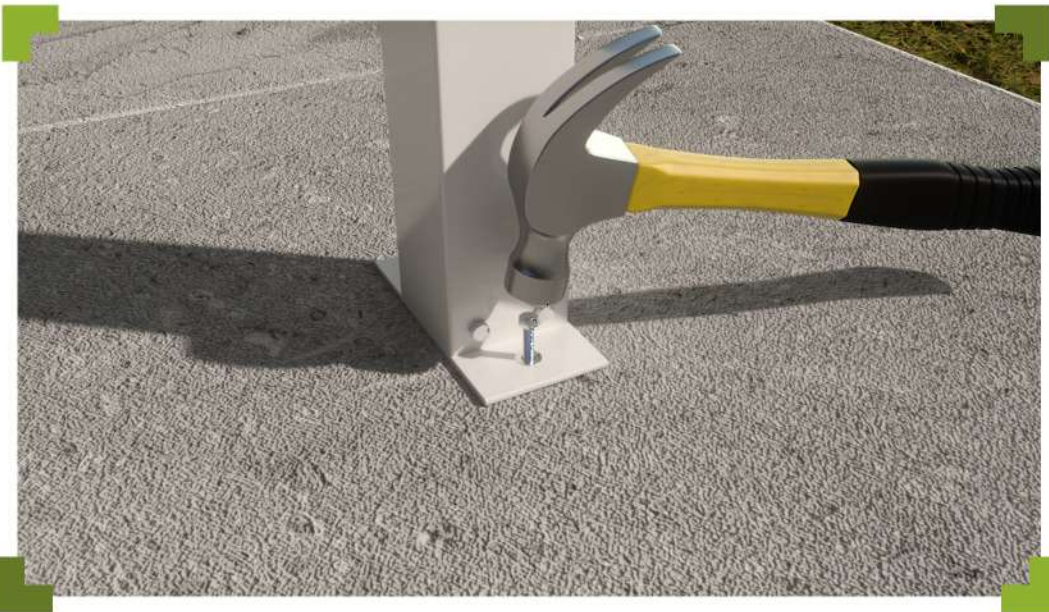

STEP 07 - B
Anchoring the POSTS

Mark BOTTOM POST BRACKET position on slab at desired location for pre-drilled holes.



STEP 07 - C
Anchoring the POSTS

Using the pre-drilled holes in bottom bracket as a guide, mark both holes on the slab or surface. Drill 3/8" diameter holes in slab or surface with masonry bit (not included) and fasten bottom post bracket to slab with two 3/8" x 2-3/4" wedge anchors. Tighten the wedge anchor.



STEP 07 - D
Anchoring the POSTS

Repeat steps A, B & C for all posts.



STEP 08 - A
Attach Side Fascia

With assistance, hold the SIDE FASCIA against house and front fascia.
Check to see if you need to trim the SIDE FASCIA at an angle to fit tight against the wall or house fascia.



STEP 08 - B
Attach Side Fascia

Cut the SIDE FASCIA. Test fit the SIDE FASCIA.
With a pencil scribe the angle of the FRONT FASCIA onto the SIDE FASCIA, then cut fascia to fit.
Mate the SIDE FASCIA to the FRONT FASCIA as shown in step 08 - C&D.

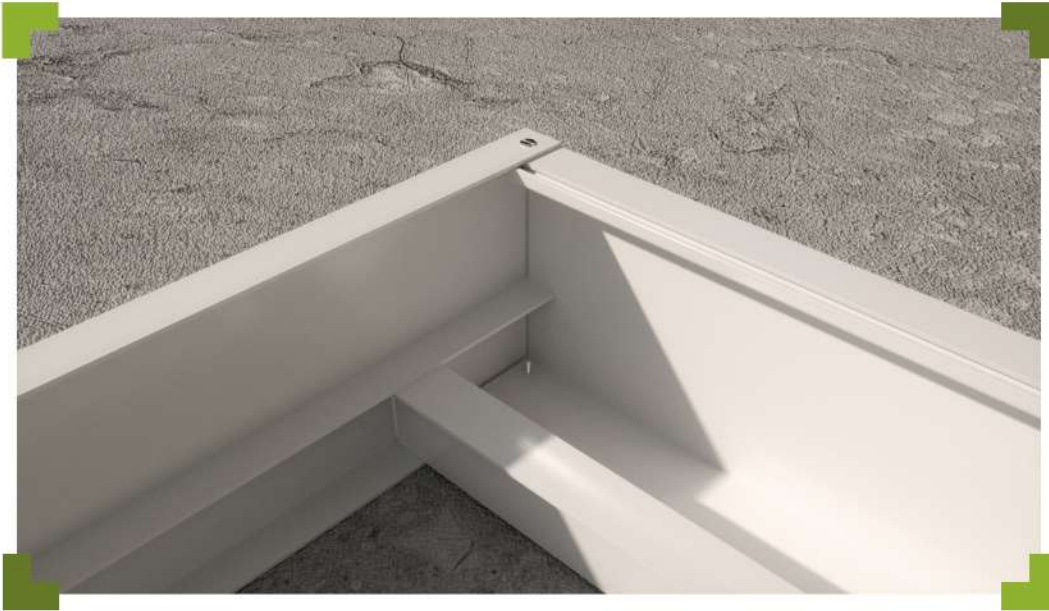

STEP 08 - C & D

Attach Side Fascia

Set the SIDE FASCIA top leg onto the HANGING CHANNEL at house end.
Fasten the SIDE FASCIA to the FRONT FASCIA.



STEP 08 - E & F

Attach Side Fascia

Fasten the SIDE FASCIA to the top leg of the HANGING CHANNEL using #8 tek screws and caulk the screw heads.
Fasten through the SIDE FASCIA to the ROOF PANEL approx. 24" spacing.



STEP 09 - A

Corner Angles

Place each CORNER ANGLE flush to fascia bottom covering the corner joint.



STEP 09 - B

Corner Angles

Mark desired height of each CORNER ANGLE and cut with tin snips or metal saw.
Fasten the CORNER ANGLES using two #8 tek screws on each side.

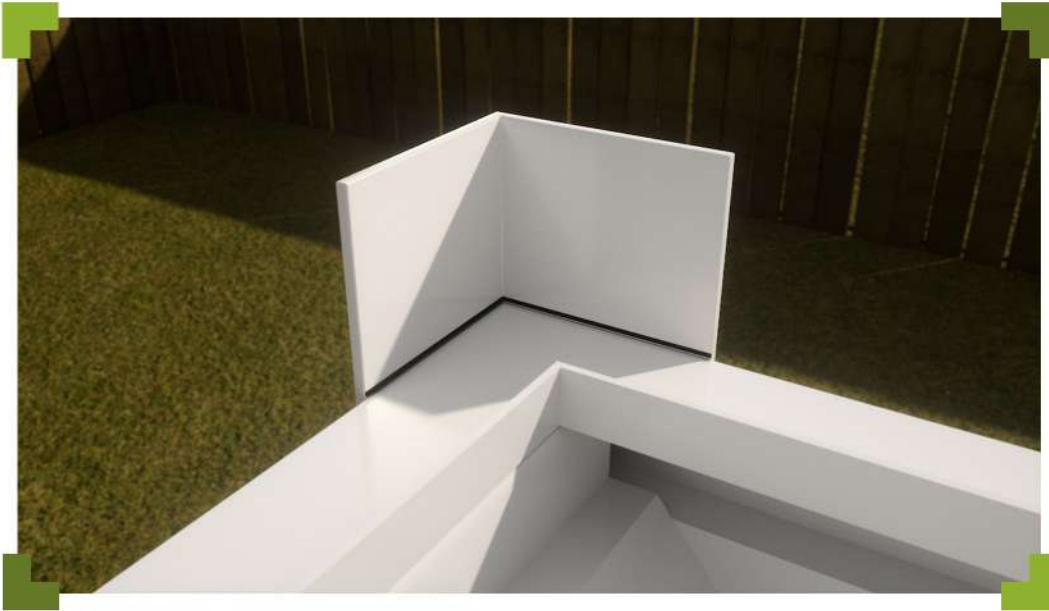

STEP 09 - C

Corner Angles

Caulk the inside corners of the FRONT FASCIA and the SIDE FASCIA to prevent leaks.
Caulk any screws inside the FRONT FASCIA to prevent leaks.



STEP 09 - D

Corner Angles

Push the foam dam into the ends of the FRONT FASCIA against SIDE FASCIA into the caulk then caulk around the foam dam inside the front fascia.



STEP 10 - A & B

Fascia Panel Clips

The ROOF PANELS should be flush/even with the top lip of FRONT FASCIA.
FASCIA PANEL CLIPS should be centered where ROOF PANELS overlap/mate together.



STEP 010 - C

Fascia Panel Clips

Insert the clip into the FRONT FASCIA groove.



STEP 10 - D
Fascia Panel Clips

Make sure the clip is centered where 2 ROOF PANELS are mated/locked together. Then slowly push the clip down and it will lock in the groove.



STEP 010 - E
Fascia Panel Clips

Fasten thru the clip into the roof panels using one #8 tek screw. Caulk the screw head.

Type #1 Fascia Drain



Type #2 Fascia Drain

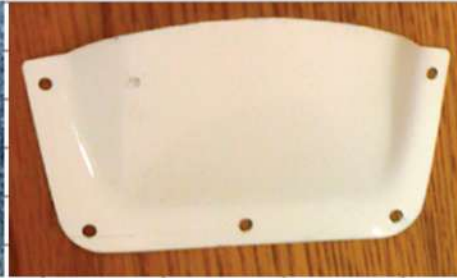

STEP 11 - A

Installing Fascia Drains

Measure 6" from both ends of FRONT FASCIA and mark with pencil on the bottom in the center.
Use the HOLE SAW to cut a 1-1/2" or 2" diameter hole through the bottom of the FRONT FASCIA.



STEP 11 - B

Installing Fascia Drains

Run a small bead of caulk around the flange of the FASCIA DRAIN.
Center the FASCIA DRAIN over the hole and press it against the bottom of FRONT FASCIA.
Then fasten using only two #8 tek screws upward into the FRONT FASCIA.



STEP 11 - C
Installing Fascia Drains

Inside the FRONT FASCIA caulk the two screws that fastened each FASCIA DRAIN.



ONLY for FRONT FASCIA wider than 16ft
fastening/sealing the front splice.



STEP 01

Preparing the FRONT FASCIA & SPLICE

Lay the front fascias parallel and evenly on a flat non-abrasive surface.

Measure your FRONT FASCIA SPLICE. If you live in the Midwest or West U.S. your splice will be 12" silver color. If you live in the Central or East your SPLICE will be 30" white.



STEP 02 - A

Preparing the FRONT FASCIA & SPLICE

Hook your measuring tape inside the SPLICE measuring & mark at 6" inside the 12". Measure over and mark at 15" inside the 30" splice.



STEP 02 - B

Preparing the FRONT FASCIA & SPLICE

Hook your measuring tape inside the FRONT FASCIA. Measure and mark inside both FRONT FASCIAS 15" if you have the 30" SPLICE. Measure and mark inside both FRONT FASCIAS 6" if you have the 12" SPLICE.

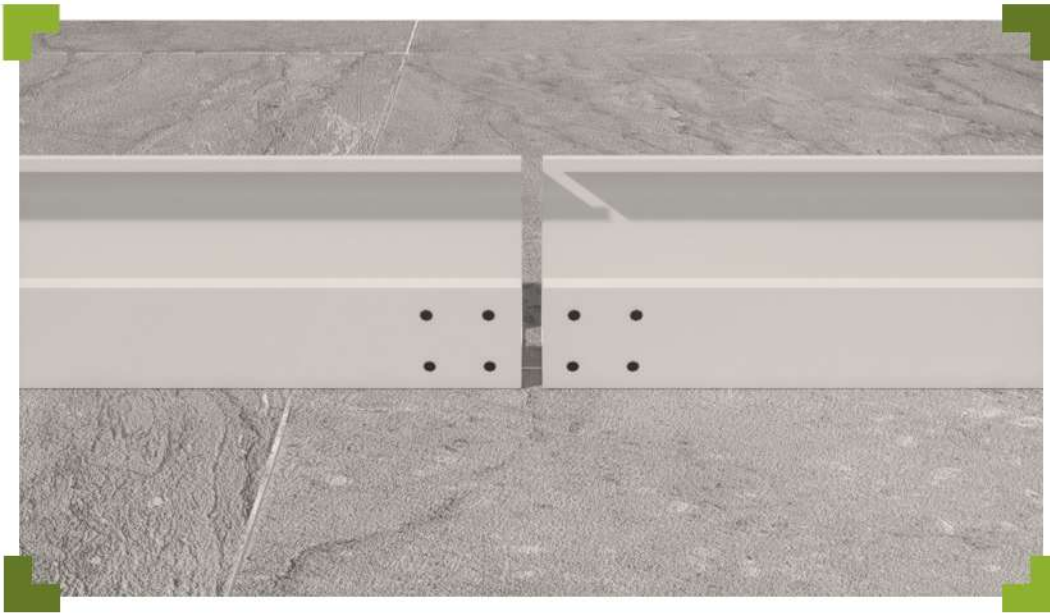

STEP 03 - A

Preparing the FRONT FASCIA for 12" SPLICE

Hook measuring tape on back side of FRONT FASCIA.

Measure over 2" & 4" in both directions of both pieces and mark with a pencil.

Measure up 3/4" from bottom and down 3/4" from top. Mark locations with a pencil.

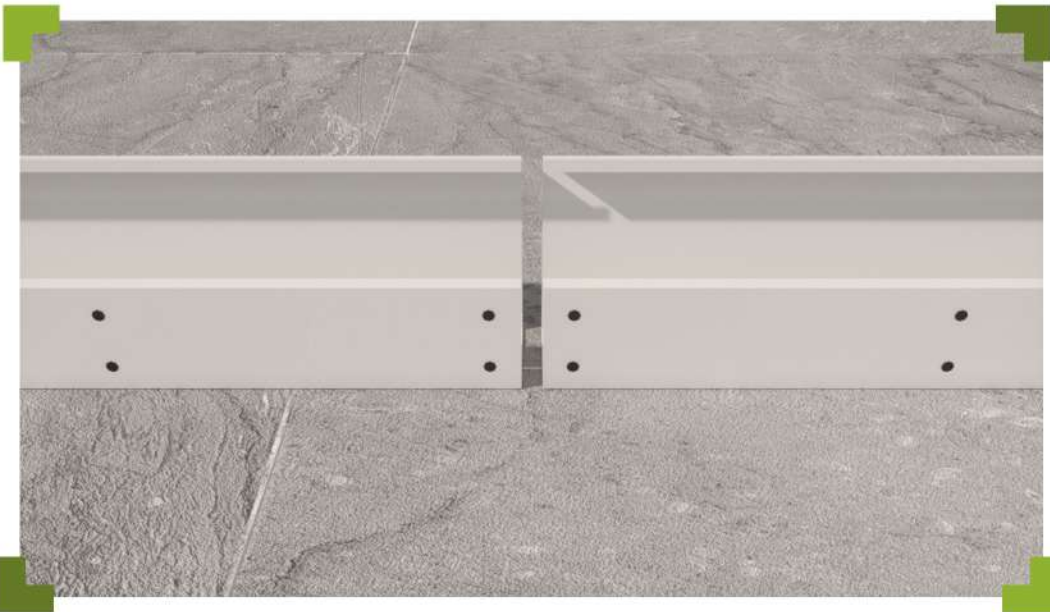

STEP 03 - B

Preparing the FRONT FASCIA for 30" SPLICE

Hook measuring tape on back side of FRONT FASCIA.

Measure over 2" & 13" in both directions and mark with a pencil.

Measure up 3/4" from bottom and down 3/4" from top. Mark locations with a pencil.



STEP 04 - A

Preparing the FRONT FASCIA for 12" SPLICE

Hook measuring tape on end of FRONT FASCIA.

Measure over 2" & 4" in both directions of both pieces and mark with a pencil.

Measure up 1-1/4" from bottom and down 1-1/4" from top. Mark locations with a pencil.



STEP 04 - B

Preparing the FRONT FASCIA for 30" SPLICE

Hook measuring tape on end of FRONT FASCIA.

Measure over 2" & 13" in both directions and mark with a pencil.

Measure up 1-1/4" from bottom and down 1-1/4" from top. Mark locations with a pencil.



STEP 05

Caulking the inside Fascias

Caulk inside both fascias stay 1 inch away from end of both fascias.

Down both corners, up & down the front and back and squiggly lines on the bottom.



STEP 06 - A

Inserting the FRONT FASCIA SPLICE for 12" SPLICE

Insert the FASCIA SPLICE in half way 6" as shown.

Push the SPLICE down into the caulking and fasten using the #8 tek screws thru FRONT FASCIA into the SPLICE where marked on both sides.

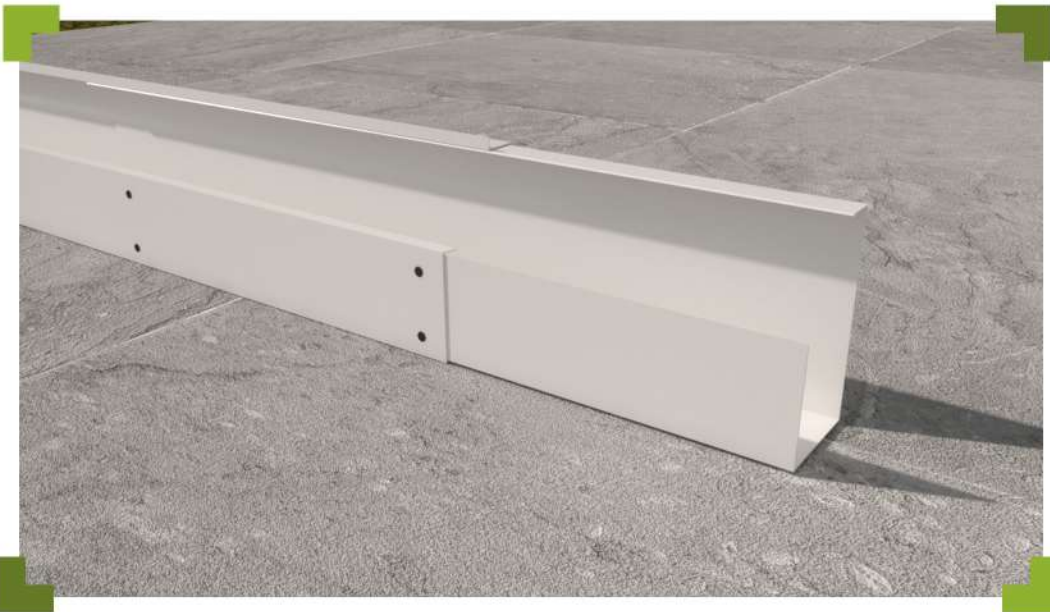

STEP 06 - B

Inserting the FRONT FASCIA SPLICE for 30" SPLICE

Insert the FASCIA SPLICE in half way 15" as shown.

Push the SPLICE down into the caulking and fasten using the #8 tek screws thru FRONT FASCIA into the SPLICE where marked on both sides.



STEP 07

Fastening the FRONT FASCIA SPLICE

Make sure both pieces of FRONT FASCIA are straight.

Then slide in the second FASCIA and fasten with screws on the marks ON THE BACK AND FRONT of FASCIA.



STEP 08

Caulking the FRONT FASCIA SPLICE

Caulk inside the FRONT FASCIA at the ends of the SPLICE & going up, the front and back sides.
Caulk all the screws protruding inside the fascia and the SPLICE.