

PSC

Applications index	E02-06
Dimple lock toolholders	E07-25
Lever lock toolholders	E26-35
Center screw toolholders	E36-50
Antivibratory adaptor	E51
Dimple lock boring bars	E52-54
Wedge clamp boring bars	E55,57
Double lock boring bars	E56
Lever lock boring bars	E58-60
Center screw boring bars	E61-67
External and internal threading	E68-69
Parting and grooving	E70-76
Drills	E77-79
Arbors and adaptors	E80-117



NEGATIVE TOOLHOLDERS

Dimple lock toolholders

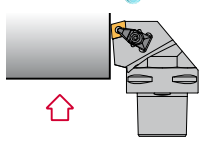
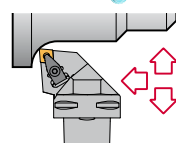
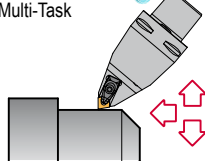
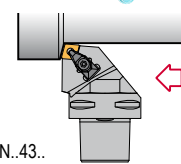
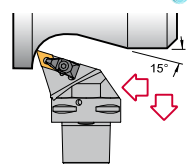
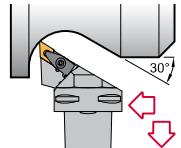
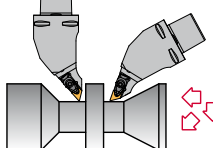
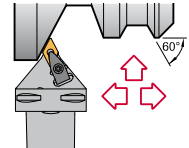
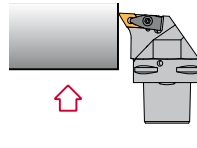
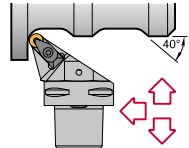
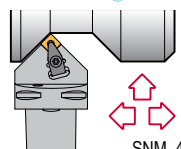
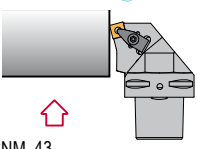
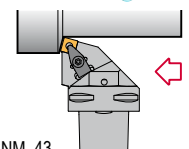
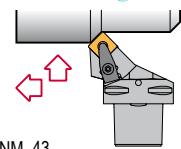
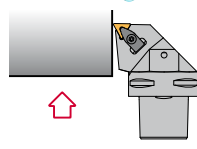
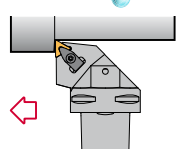
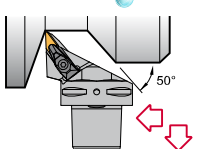
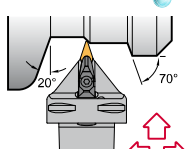
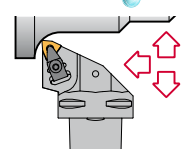
<p>DCKN 75°</p>  <p>CN..43.. CN..54.. CN..64..</p> <p>Page E07</p>	<p>DCLN 95°</p>  <p>CN..32.. CN..64..</p> <p>Page E08</p>	<p>DCMN 50° Multi-Task</p>  <p>CN..43.. CN..54.. CN..64..</p> <p>Page E09</p>	<p>DCRN 75°</p>  <p>CN..43.. CN..54.. CN..64..</p> <p>Page E10</p>	<p>DDHN 107°30'</p>  <p>DN..44..</p> <p>Page E11</p>
<p>DDJN 93°</p>  <p>DN..33.. DN..44..</p> <p>Page E12</p>	<p>DDMN 48° Multi-Task</p>  <p>DN..44..</p> <p>Page E13</p>	<p>DDNN 63°</p>  <p>DN..33.. DN..44..</p> <p>Page E14</p>	<p>DDUN 93°</p>  <p>DN..44..</p> <p>Page E15</p>	<p>DRSN</p>  <p>RNMG43..</p> <p>Page E16</p>
<p>DSDN 45°</p>  <p>SNM..43.. SNM..54.. SNM..64..</p> <p>Page E17</p>	<p>DSKN 75°</p>  <p>SNM..43.. SNM..54.. SNM..64..</p> <p>Page E18</p>	<p>DSRN 75°</p>  <p>SNM..43.. SNM..54.. SNM..64..</p> <p>Page E19</p>	<p>DSSN 45°</p>  <p>SNM..43.. SNM..54.. SNM..64..</p> <p>Page E20</p>	<p>DTFN 90°</p>  <p>TNM..33.. TNM..43..</p> <p>Page E21</p>
<p>DTGN 90°</p>  <p>TNM..33.. TNM..43..</p> <p>Page E22</p>	<p>DVJN 93°</p>  <p>VN..33..</p> <p>Page E23</p>	<p>DVVN 72°30'</p>  <p>VN..33..</p> <p>Page E24</p>	<p>DWLN 95°</p>  <p>WNMG33.. WNMG43..</p> <p>Page E25</p>	



NEGATIVE TOOLHOLDERS

Lever lock toolholders

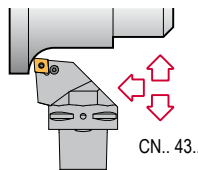
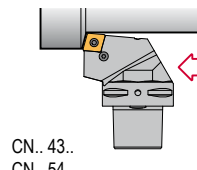
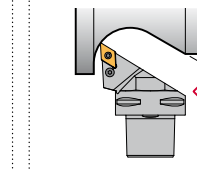
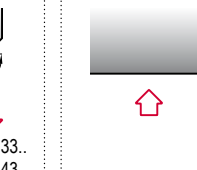
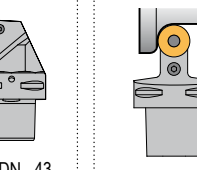
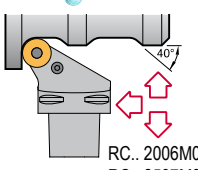
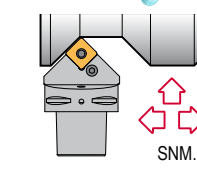
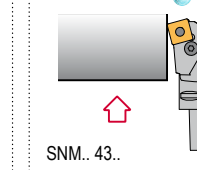
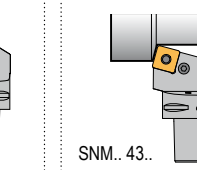
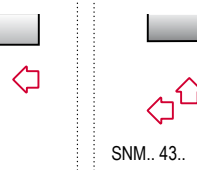
<p>PCLN 95°</p>  <p>CN.. 43.. CN.. 2509..</p> <p>Page E26</p>	<p>PCRN 75°</p>  <p>CN.. 43.. CN.. 54.. CN.. 64..</p> <p>Page E27</p>	<p>PDJN 93°</p>  <p>DN.. 33.. DN.. 43.. DN.. 44..</p> <p>Page E28</p>	<p>PDUN 93°</p>  <p>DN.. 43.. DN.. 44..</p> <p>Page E29</p>	<p>PRDC</p>  <p>RC.. 2507M0 RC.. 3209M0</p> <p>Page E30</p>
<p>PRSC</p>  <p>RC.. 2006M0 RC.. 2507M0 RC.. 3209M0</p> <p>Page E31</p>	<p>PSDN 45°</p>  <p>SNM.. 43.. SNM.. 85..</p> <p>Page E32</p>	<p>PSKN 75°</p>  <p>SNM.. 43.. SNM.. 85..</p> <p>Page E33</p>	<p>PSRN 75°</p>  <p>SNM.. 43.. SNM.. 85..</p> <p>Page E34</p>	<p>PSSN 45°</p>  <p>SNM.. 43.. SNM.. 85..</p> <p>Page E35</p>

POSITIVE TOOLHOLDERS

Center screw toolholders

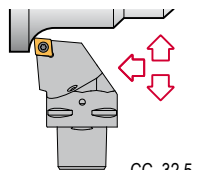
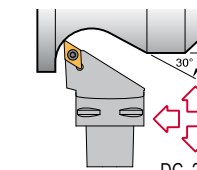
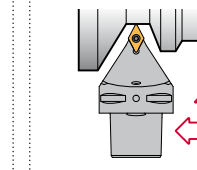
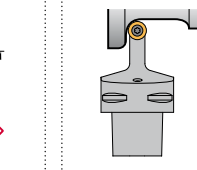
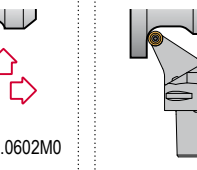
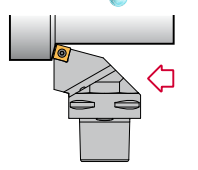
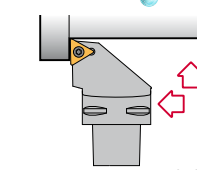
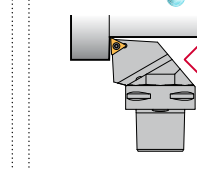
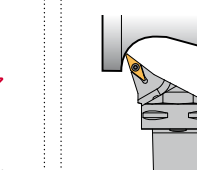
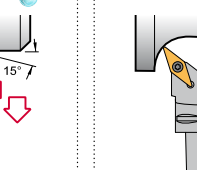
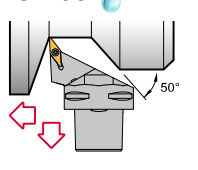
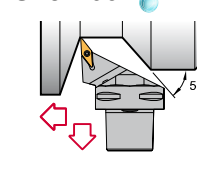
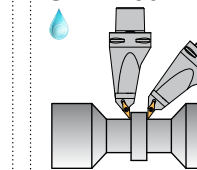
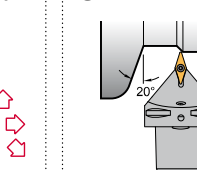
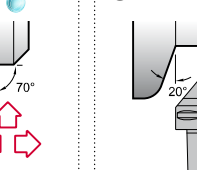
<p>SCLC 95°</p>  <p>CC..32.5.. CC..43..</p> <p>Page E36</p>	<p>SDJC 93°</p>  <p>DC..21.5.. DC..32.5..</p> <p>Page E37</p>	<p>SDNC 62°30'</p>  <p>DC..32.5..</p> <p>Page E38</p>	<p>SRDC</p>  <p>RC..0602M0 RC..2006M0</p> <p>Page E39</p>	<p>SRSC 45°</p>  <p>RC..0602M0 RC..2006M0</p> <p>Page E40</p>
<p>SSRC 75°</p>  <p>SC..43..</p> <p>Page E41</p>	<p>STGC 90°</p>  <p>TC..21.5.. TC..32.5..</p> <p>Page E42</p>	<p>STJC 93°</p>  <p>TC..21.5.. TC..32.5..</p> <p>Page E43</p>	<p>SVHB 107°30'</p>  <p>VBMT33..</p> <p>Page E44</p>	<p>SVHC 107°30'</p>  <p>VC..22.. VC..33..</p> <p>Page E45</p>
<p>SVJB 93°</p>  <p>VBMT33..</p> <p>Page E46</p>	<p>SVJC 93°</p>  <p>VC..22.. VC..33..</p> <p>Page E47</p>	<p>SVMB 50° Multi-Task</p>  <p>VBMT33..</p> <p>Page E48</p>	<p>SVVB 72°30'</p>  <p>VBMT33..</p> <p>Page E49</p>	<p>SVVC 72°30'</p>  <p>VC..22.. VC..33..</p> <p>Page E50</p>



NEGATIVE BORING BARS





Adaptor

J..  



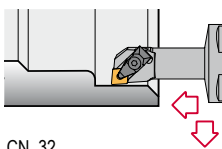

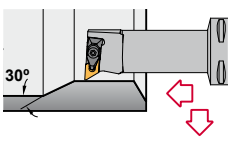

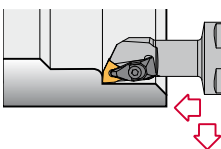
Page E51



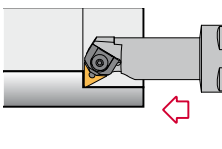

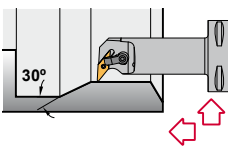
Dimple lock boring bars

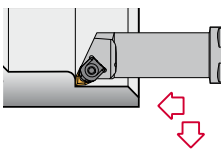
<p>DCLN 95° </p>  <p>CN..32.. CN..43.. CN..54..</p> <p>Page E52</p>	<p>DDUN 93° </p>  <p>30°</p> <p>DN..33.. DN..44..</p> <p>Page E53</p>	<p>DWLN 95° </p>  <p>WNUMG33.. WNUMG43..</p> <p>Page E54</p>
--	--	---

Wedge clamp / Double lock boring bars

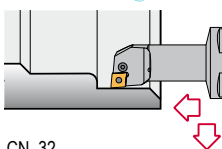

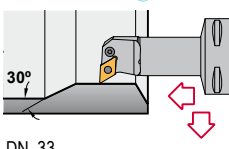

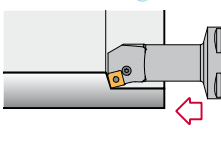





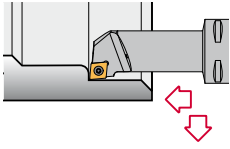

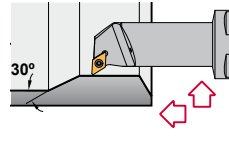
<p>MTFN 90° </p>  <p>TNM..33..</p> <p>Page E55</p>	<p>MVUN 93° </p>  <p>30°</p> <p>VN..33..</p> <p>Page E56</p>	<p>MWLN 95° </p>  <p>WNUMG33.. WNUMG43..</p> <p>Page E57</p>		
---	---	---	--	--

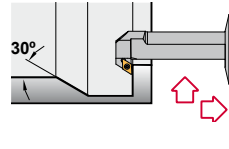
Lever lock boring bars

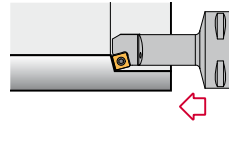
<p>PCLN 95° </p>  <p>CN..32.. CN..43.. CN..54..</p> <p>Page E58</p>	<p>PDUN 93° </p>  <p>30°</p> <p>DN..33.. DN..43.. DN..44..</p> <p>Page E59</p>	<p>PSKN 75° </p>  <p>SNM..43..</p> <p>Page E60</p>		
--	---	---	--	--

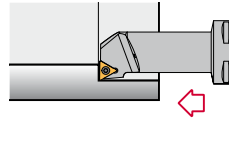

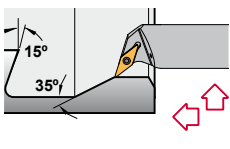
POSITIVE BORING BARS

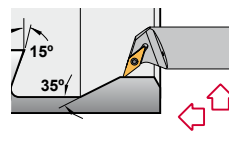
Center screw boring bars

<p>SCLC 95° </p>  <p>Page E61 CC..32.5.. CC..43..</p>	<p>SDUC 93° </p>  <p>Page E62 DC..21.5.. DC..32.5..</p>	<p>SDUC-X 93° </p>  <p>Page E63 DC..21.5..</p>	<p>SSKC 75° </p>  <p>Page E64 SC..32.5..</p>	<p>STFC 90° </p>  <p>Page E65 TC..21.5.. TC..32.5..</p>
<p>SVQB 107°30' </p>  <p>Page E66 VBMT33..</p>	<p>SVQC 107°30' </p>  <p>Page E67 VC..22.. VC..33..</p>			

THREADING

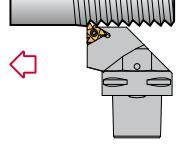

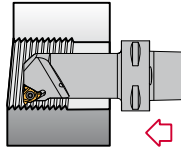



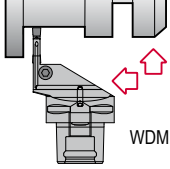
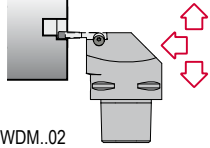
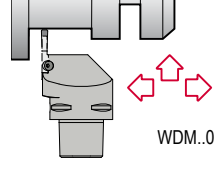

External and internal threading

<p>SE 90° </p>  <p>Page E68 16ER/L.. 22ER/L..</p>	<p>SI 90° </p>  <p>Page E69 16NR/L.. 22NR/L..</p>			
---	---	--	--	--

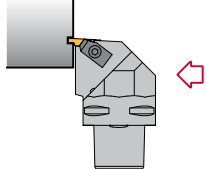

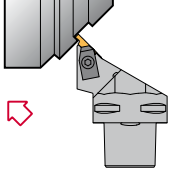
PARTING AND GROOVING

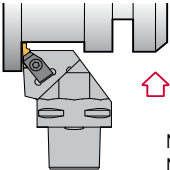
Toolholders and boring bars

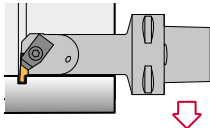
<p>CZCD </p>  <p>WDM..02 .. WDM..06</p> <p>Page E70</p>	<p>CZFD</p>  <p>WDM..02 .. WDM..06</p> <p>Page E71</p>	<p>CZGD</p>  <p>WDM..02 .. WDM..06</p> <p>Page E72</p>	<p>NE 93° </p>  <p>Page E73</p> <p>N..3</p>	<p>NR 45° </p>  <p>Page E74</p> <p>N..3</p>
<p>NS 93° </p>  <p>N..2 N..3 N..4</p> <p>Page E75</p>	<p>NNTO 93° </p>  <p>N..2 N..3 N..4</p> <p>Page E76</p>			

DRILLS

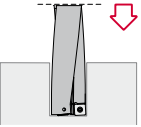
<p>45.. </p>  <p>SPMT0603.. .. SPMT1204.. Page E77-79</p>				
--	--	--	--	--





Characteristics:
 Multipurpose toolholder equipped with rhombic negative double-sided insert (angle 80°).
 PSC with internal coolant.

- 1) γ = Rake angle (valid with a flat insert).
- 2) λ_s = Angle of inclination.

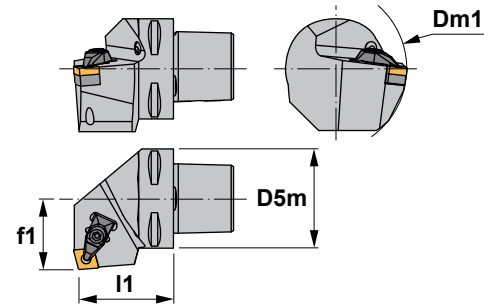

DCKN 75°





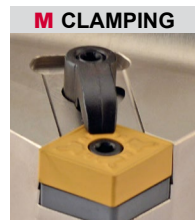

Reference	D5m	Dm1 min.	f1	l1	γ 1)	λ_s 2)	Insert size	
PSC40-DCKNR/L27050-12	1.575	4.331	1.063	1.969	-6°	-6°	CN..43..	0.930
PSC50-DCKNR/L35060-12	1.969	4.331	1.378	2.362	-6°	-6°	CN..43..	1.765
PSC63-DCKNR/L45065-12	2.480	4.331	1.772	2.559	-6°	-6°	CN..43..	2.425
PSC40-DCKNR/L27050-16	1.575	4.921	1.063	1.969	-6°	-6°	CN..54..	0.930
PSC50-DCKNR/L35060-16	1.969	4.921	1.378	2.362	-6°	-6°	CN..54..	1.765
PSC63-DCKNR/L45065-16	2.480	4.921	1.772	2.559	-6°	-6°	CN..54..	2.425
PSC63-DCKNR/L45065-19	2.480	4.921	1.772	2.559	-6°	-6°	CN..64..	2.425
PSC80-DCKNR/L55080-19	3.150	4.921	2.165	3.150	-6°	-6°	CN..64..	6.040

Reference							Nm
PSC...-12	1766	ICSN-442	2712	1696	4295	5004	3.5
PSC...-16	1768	ICSN-533	2716	1696	4295	5004	3.5
PSC...-19	1770	ICSN-633	2719	1696	4295	5004	3.5

Optional clamping systems



M CLAMPING

Reference							Nm
PSC...-12	2613	1086	5003	ICSN-442	1657	5025	3.0
PSC...-16	2614	1086	5003	ICSN-533	1673	5003	3.0
PSC...-19	2614	1086	5003	ICSN-633	1674	5004	3.0



C CLAMPING

Reference							Nm
PSC...-12-4	1766	ICSN-442	9414	2713	1086	5003	3.0
PSC...-12-7	1766	ICSN-422	9414	2713	1086	5003	3.0
PSC...-16	1768	ICSN-523	9414	2713	1086	5003	3.0
PSC...-19	1770	ICSN-623	9414	2713	1086	5003	3.0





Characteristics:
 Multipurpose toolholder equipped with rhombic negative double-sided insert (angle 80°).
 PSC with internal coolant.

- 1) γ = Rake angle (valid with a flat insert).
- 2) λ_s = Angle of inclination.

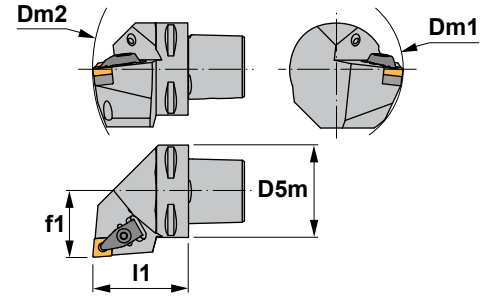

DCLN 95°

Reference	D5m	Dm1 min.	Dm2 min.	f1	l1	γ^1	λ_s^2	Insert size	
PSC32-DCLNR/L22040-09	1.260	2.362	4.567	0.866	1.575	-6°	-6°	CN..32..	0.465
PSC40-DCLNR/L27050-09	1.575	2.362	5.512	1.063	1.969	-6°	-6°	CN..32..	0.930
PSC32-DCLNR/L22045-12	1.260	2.362	4.764	0.866	1.772	-6°	-6°	CN..43..	0.530
PSC40-DCLNR/L27050-12	1.575	4.331	5.512	1.063	1.969	-6°	-6°	CN..43..	0.930
PSC50-DCLNR/L35060-12	1.969	4.331	6.496	1.378	2.362	-6°	-6°	CN..43..	1.765
PSC63-DCLNR/L45065-12	2.480	4.331	7.480	1.772	2.559	-6°	-6°	CN..43..	2.425
PSC80-DCLNR/L55080-12	3.150	4.331	9.843	2.165	3.150	-6°	-6°	CN..43..	6.040
PSC40-DCLNR/L27055-16	1.575	4.921	5.709	1.063	2.165	-6°	-6°	CN..54..	0.950
PSC50-DCLNR/L35060-16	1.969	4.921	6.496	1.378	2.362	-6°	-6°	CN..54..	1.765
PSC63-DCLNR/L45065-16	2.480	4.921	7.480	1.772	2.559	-6°	-6°	CN..54..	2.425
PSC80-DCLNR/L55080-16	3.150	4.921	9.843	2.165	3.150	-6°	-6°	CN..54..	6.040
PSC50-DCLNR/L35060-19	1.969	4.921	6.496	1.378	2.362	-6°	-6°	CN..64..	1.765
PSC63-DCLNR/L45065-19	2.480	4.921	7.480	1.772	2.559	-6°	-6°	CN..64..	2.425
PSC80-DCLNR/L55080-19	3.150	4.921	9.843	2.165	3.150	-6°	-6°	CN..64..	6.040

Reference							Nm
PSC...-09	1764	ICSN-332	2708	1695	4294	5004	3.5
PSC...-12	1766	ICSN-442	2712	1696	4295	5004	3.5
PSC...-16	1768	ICSN-533	2716	1696	4295	5004	3.5
PSC...-19	1770	ICSN-633	2719	1696	4295	5004	3.5

Optional clamping systems

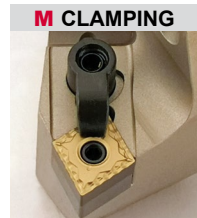

M CLAMPING

Reference							Nm
PSC...-09	2604	1085	5025	ICSN-332	1665	5002	2.0
PSC...-12	2613	1086	5003	ICSN-442	1657	5025	3.0
PSC...-16	2614	1086	5003	ICSN-533	1673	5003	3.0
PSC...-19	2614	1086	5003	ICSN-633	1674	5004	3.0



C CLAMPING

Reference							Nm
PSC...-12-4	1766	ICSN-442	9414	2713	1086	5003	3.0
PSC...-12-7	1766	ICSN-422	9414	2713	1086	5003	3.0
PSC...-16	1768	ICSN-523	9414	2713	1086	5003	3.0



Characteristics:
 Toolholder for multi-task machining equipped with rhombic negative inserts (angle 80°).
 PSC with internal coolant.

- 1) γ = Rake angle (valid with a flat insert).
- 2) λ_s = Angle of inclination.

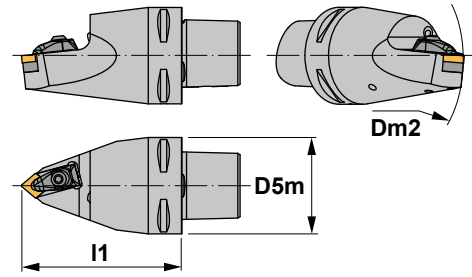

Main application

Alternative use

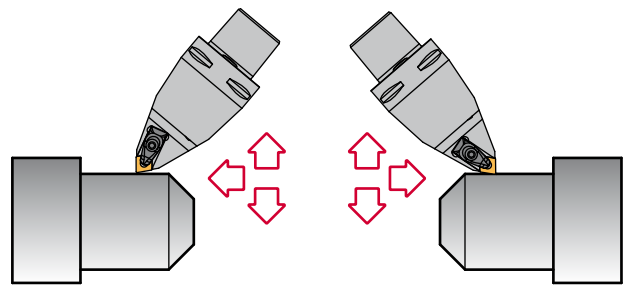

DCMN 50°

Reference	D5m	Dm2 min.	I1	γ^1	λ_s^2	Insert size	
PSC63-DCMNN00115-12	2.480	4.331	4.528	-6°	-6°	CN..43..	3.750
PSC80-DCMNN00150-16	3.150	4.528	5.906	-6°	-6°	CN..54..	7.275

Reference							Nm
PSC63-DCMNN00115-12	1766	ICSN-442	2712	1696	4295	5004	3.5
PSC80-DCMNN00150-16	1768	ICSN-533	2716	1696	4295	5004	3.5

CN.. 80° rhombic negative inserts.  A24-26

Reference	I	T	d
CN..43..	0.508	0.187	0.500
CN..54..	0.633	0.250	0.625

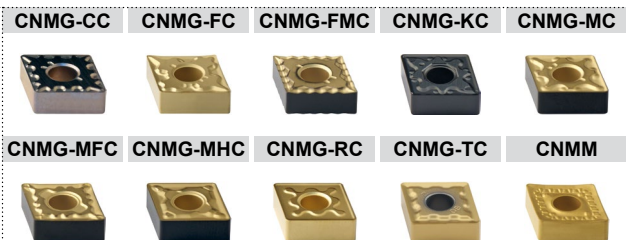
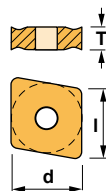



Characteristics:
 Multipurpose toolholder equipped with rhombic negative double-sided insert (angle 80°).
 PSC with internal coolant.

- 1) γ = Rake angle (valid with a flat insert).
- 2) λ_s = Angle of inclination.

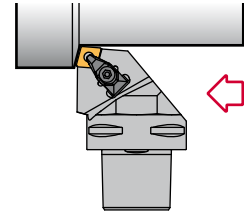
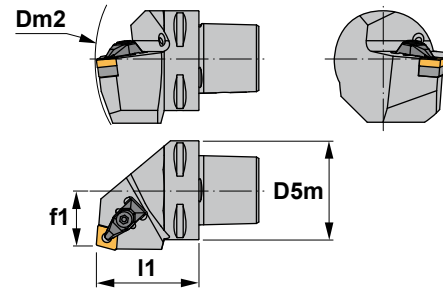

DCRN 75°

Reference	D5m	Dm2 min.	f1	I1	γ 1)	λ_s 2)	Insert size	lbs
PSC40-DCRNR/L22050-12	1.575	5.512	0.866	1.969	-6°	-6°	CN..43..	0.930
PSC50-DCRNR/L27060-12	1.969	6.496	1.063	2.362	-6°	-6°	CN..43..	1.765
PSC63-DCRNR/L35065-12	2.480	7.480	1.378	2.559	-6°	-6°	CN..43..	3.085
PSC50-DCRNR/L27060-16	1.969	6.496	1.063	2.362	-6°	-6°	CN..54..	1.765
PSC63-DCRNR/L35065-16	2.480	7.480	1.378	2.559	-6°	-6°	CN..54..	3.085
PSC80-DCRNR/L55080-16	3.150	9.843	2.165	3.150	-6°	-6°	CN..54..	6.040
PSC50-DCRNR/L27060-19	1.969	6.496	1.063	2.362	-6°	-6°	CN..64..	1.765
PSC63-DCRNR/L35065-19	2.480	7.480	1.378	2.559	-6°	-6°	CN..64..	3.085
PSC80-DCRNR/L55080-19	3.150	9.843	2.165	3.150	-6°	-6°	CN..64..	6.040

Reference							Nm
PSC...-12	1766	ICSN-442	2712	1696	4295	5004	3.5
PSC...-16	1768	ICSN-533	2716	1696	4295	5004	3.5
PSC...-19	1770	ICSN-633	2719	1696	4295	5004	3.5

Optional clamping systems



M CLAMPING

Reference							Nm
PSC...-12	2613	1086	5003	ICSN-442	1657	5025	3.0
PSC...-16	2614	1086	5003	ICSN-533	1673	5003	3.0
PSC...-19	2614	1086	5003	ICSN-633	1674	5004	3.0



C CLAMPING

Reference							Nm
PSC...-12-4	1766	ICSN-442	9414	2713	1086	5003	3.0
PSC...-12-7	1766	ICSN-422	9414	2713	1086	5003	3.0
PSC...-16	1768	ICSN-523	9414	2713	1086	5003	3.0
PSC...-19	1770	ICSN-623	9414	2713	1086	5003	3.0



Characteristics:

Turning and profiling toolholder equipped with rhombic negative double-sided insert (angle 55°).

PSC with internal coolant.

- 1) γ = Rake angle (valid with a flat insert).
- 2) λ_s = Angle of inclination.

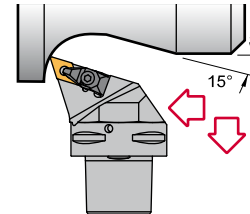
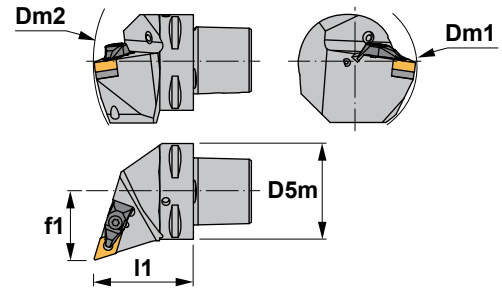

DDHN 107° 30'

Reference	D5m	Dm1 min.	Dm2 min.	f1	l1	$\gamma^{(1)}$	$\lambda_s^{(2)}$	Insert size	lbs
PSC40-DDHNR/L27055-15	1.575	4.331	5.709	1.063	2.165	-6°	-7°	DN..44..	0.950
PSC50-DDHNR/L35060-15	1.969	4.331	6.496	1.378	2.362	-6°	-7°	DN..44..	1.765
PSC63-DDHNR/L45065-15	2.480	4.331	7.480	1.772	2.559	-6°	-7°	DN..44..	2.425
PSC80-DDHNR/L55080-15	3.150	4.331	9.843	2.165	3.150	-6°	-7°	DN..44..	6.040

Reference							Nm
PSC40-DDHNR/L27055-15	1766	IDSN-432	2712	1696	4295	5004	3.5
PSC50-DDHNR/L35060-15	1766	IDSN-432	2712	1696	4295	5004	3.5
PSC63-DDHNR/L45065-15	1766	IDSN-432	2712	1696	4295	5004	3.5
PSC80-DDHNR/L55080-15	1766	IDSN-432	2712	1696	4295	5004	3.5

Optional clamping systems



M CLAMPING

Reference							Nm
PSC...-15	2613	1086	5003	IDSN-432	1657	5025	3.5



C CLAMPING

Reference							Nm
PSC...-15	1766	IDSN-422	9416	2717	1086	5003	3.0





Characteristics:
 Turning and profiling toolholder equipped with rhombic negative double-sided insert (angle 55°).
 PSC with internal coolant.

- 1) γ = Rake angle (valid with a flat insert).
- 2) λ_s = Angle of inclination.

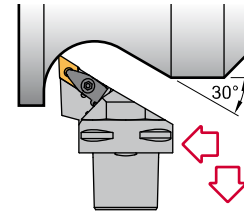
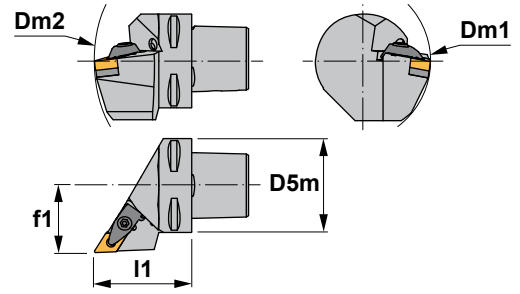

DDJN 93°

Reference	D5m	Dm1 min.	Dm2 min.	f1	l1	γ^1	λ_s^2	Insert size	
PSC32-DDJNR/L22045-11	1.260	2.362	4.764	0.866	1.772	-6°	-7°	DN..33..	0.530
PSC40-DDJNR/L27050-11	1.575	2.362	5.512	1.063	1.969	-6°	-7°	DN..33..	0.930
PSC50-DDJNR/L35060-11	1.969	2.559	6.496	1.378	2.362	-6°	-7°	DN..33..	1.765
PSC63-DDJNR/L45065-11	2.480	3.189	7.480	1.772	2.559	-6°	-7°	DN..33..	2.425
PSC40-DDJNR/L27055-15	1.575	4.331	5.709	1.063	2.165	-6°	-7°	DN..44..	0.930
PSC50-DDJNR/L35060-15	1.969	4.331	6.496	1.378	2.362	-6°	-7°	DN..44..	1.765
PSC63-DDJNR/L45065-15	2.480	4.331	7.480	1.772	2.559	-6°	-7°	DN..44..	2.425
PSC80-DDJNR/L55080-15	3.150	4.331	9.843	2.165	3.150	-6°	-7°	DN..44..	6.040

Reference							Nm
PSC...-11	1764	IDSN-322	2708	1695	4294	5004	3.5
PSC...-15	1766	IDSN-432	2712	1696	4295	5004	3.5

Optional clamping systems

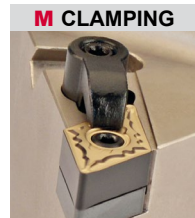

M CLAMPING

Reference							Nm
PSC...-11	2604	1085	5025	IDSN-322	1665	5002	2.0
PSC...-15	2613	1086	5003	IDSN-432	1657	5025	3.0



C CLAMPING

Reference						Nm	
PSC...-15	1766	IDSN-422	9416	2717	1086	5003	3.0



Characteristics:
 Toolholder for multi-task machining equipped with rhombic negative inserts (angle 55°).
 PSC with internal coolant.

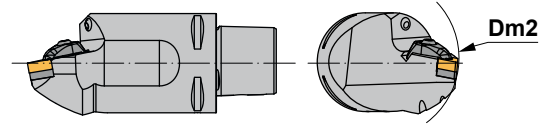

1) γ = Rake angle (valid with a flat insert).
 2) λ_s = Angle of inclination.

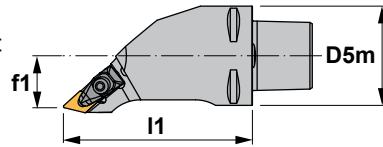

Main application

Alternative use

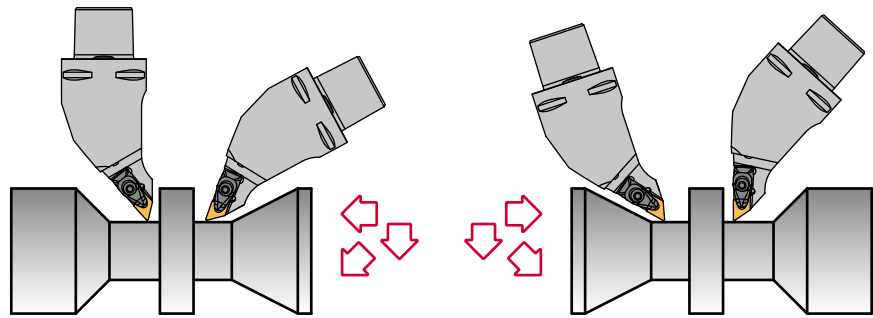

DDMN 48°

Reference	D5m	Dm2 min.	f1	l1	γ^1	λ_s^2	Insert size	lbs
PSC63-DDMNR/L33120-15	2.480	5.118	1.299	4.724	-5°	-9°	DN..44..	5.070

Reference							Nm
PSC63-DDMNR/L33120-15	1766	IDSN-432	2712	1696	4295	5004	3.5

DN..		55° rhombic negative inserts. A28-30		
Reference	l	T	d	
DN..44..	0.610	0.250	0.500	

DNMA	DNMG-FC	DNMG-FMC	DNMG-KC
DNMG-MC	DNMG-MHC	DNMG-TC	DNMX



Characteristics:

Profiling toolholder equipped with rhombic negative double-sided insert (angle 55°). PSC with internal coolant.

- 1) γ = Rake angle (valid with a flat insert).
- 2) λ_s = Angle of inclination.

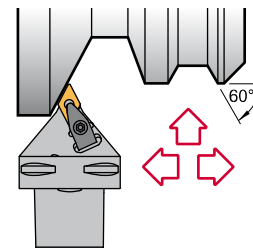
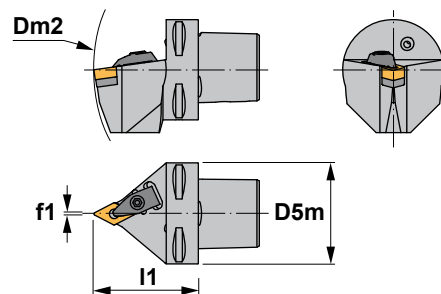

DDNN 63°

Reference	D5m	Dm2 min.	f1	l1	γ^1	λ_s^2	Insert size	
PSC40-DDNNN00050-11	1.575	5.512	0.020	1.969	-5°	-9°	DN..33..	0.770
PSC50-DDNNN00060-11	1.969	6.496	0.020	2.362	-5°	-9°	DN..33..	1.655
PSC40-DDNNN00055-15	1.575	5.709	0.020	2.165	-5°	-9°	DN..44..	0.770
PSC50-DDNNN00060-15	1.969	6.496	0.020	2.362	-5°	-9°	DN..44..	1.655
PSC63-DDNNN00065-15	2.480	7.480	0.020	2.559	-5°	-9°	DN..44..	2.360
PSC80-DDNNN00080-15	3.150	9.843	0.020	3.150	-5°	-9°	DN..44..	5.115

Reference							Nm
PSC...-11	1764	IDSN-322	2708	1695	4294	5004	3.5
PSC...-15	1766	IDSN-432	2712	1696	4295	5004	3.5

Optional clamping systems



Reference							Nm
PSC...-11	2604	1085	5025	IDSN-322	1665	5002	2.0
PSC...-15	2613	1086	5003	IDSN-432	1657	5025	3.0



Reference							Nm
PSC...-15	1766	IDSN-422	9416	2717	1086	5003	3.0



Characteristics:
 Turning and profiling toolholder equipped with rhombic negative double-sided insert (angle 55°).
 PSC with internal coolant.

- 1) γ = Rake angle (valid with a flat insert).
- 2) λ_s = Angle of inclination.

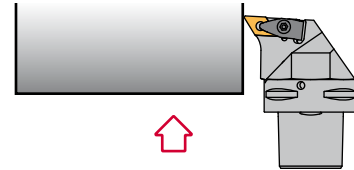
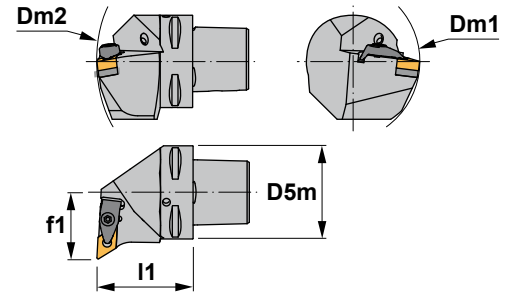

DDUN 93°

Reference	D5m	Dm1 min.	Dm2 min.	f1	l1	γ (1)	λ_s (2)	Insert size	
PSC40-DDUNR/L27050-15	1.575	4.331	5.512	1.063	1.969	-6°	-7°	DN..44..	0.930
PSC50-DDUNR/L35060-15	1.969	4.331	6.496	1.378	2.362	-6°	-7°	DN..44..	1.765
PSC63-DDUNR/L45065-15	2.480	4.331	7.480	1.772	2.559	-6°	-7°	DN..44..	2.425
PSC80-DDUNR/L55080-15	3.150	4.331	9.843	2.165	3.150	-6°	-7°	DN..44..	6.040

Reference							Nm
PSC40-DDUNR/L27050-15	1766	IDSN-432	2712	1696	4295	5004	3.5
PSC50-DDUNR/L35060-15	1766	IDSN-432	2712	1696	4295	5004	3.5
PSC63-DDUNR/L45065-15	1766	IDSN-432	2712	1696	4295	5004	3.5
PSC80-DDUNR/L55080-15	1766	IDSN-432	2712	1696	4295	5004	3.5

Optional clamping systems



M CLAMPING

Reference							Nm
PSC...-15	2613	1086	5003	IDSN-432	1657	5025	3.0



C CLAMPING

Reference							Nm
PSC...-15	1766	IDSN-422	9416	2717	1086	5003	3.0





Characteristics:
Profiling multipurpose turning toolholder equipped with round negative insert. PSC with internal coolant.

- 1) γ = Rake angle (valid with a flat insert).
- 2) λ_s = Angle of inclination.

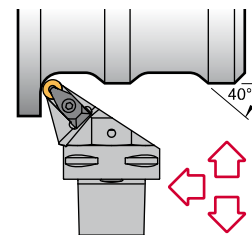
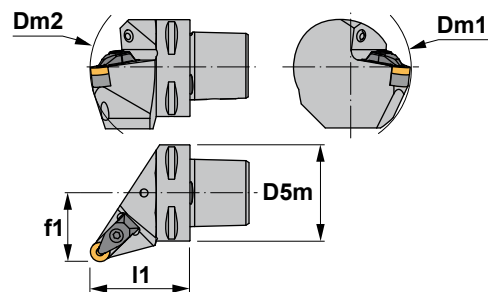

DRSN

Reference	D5m	Dm1 min.	Dm2 min.	f1	l1	γ^1	λ_s^2	Insert size	
PSC40-DRSNR/L27050-12	1.575	4.331	5.512	1.063	1.969	-6°	-6°	RNMG43..	0.930
PSC50-DRSNR/L35060-12	1.969	4.331	6.496	1.378	2.362	-6°	-6°	RNMG43..	1.765
PSC63-DRSNR/L45065-12	2.480	4.331	7.480	1.772	2.559	-6°	-6°	RNMG43..	2.425

Reference							Nm
PSC40-DRSNR/L27050-12	1766	IRSN-44	2712	1696	4295	5004	3.5
PSC50-DRSNR/L35060-12	1766	IRSN-44	2712	1696	4295	5004	3.5
PSC63-DRSNR/L45065-12	1766	IRSN-44	2712	1696	4295	5004	3.5

Optional clamping systems



M CLAMPING

Reference							Nm
PSC...-12	2613	1086	5003	IRSN-44	1657	5025	3.5



C CLAMPING

Reference						Nm	
PSC...-12-4	1766	IRSN-44	9414	2713	1086	5003	3.0
PSC...-12-7	1766	IRSN-42	9414	2713	1086	5003	3.0

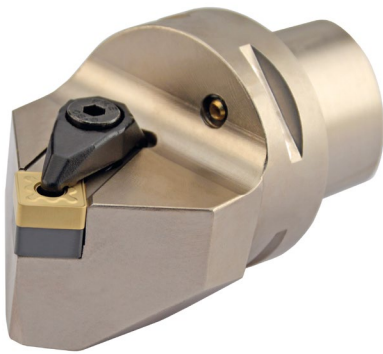

Characteristics:

Toolholder for external turning and chamfering applications equipped with square negative inserts.
PSC with internal coolant.

- 1) γ = Rake angle (valid with a flat insert).
- 2) λ_s = Angle of inclination.

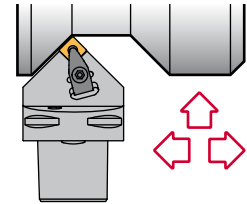
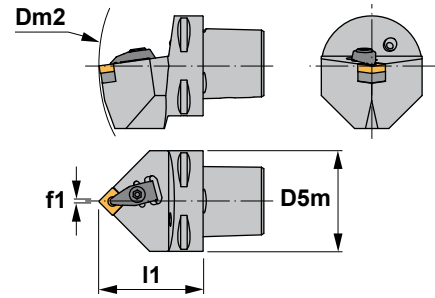

DSDN 45°

Reference	D5m	Dm2 min.	f1	l1	γ^1	λ_s^2	Insert size	
PSC32-DSDNN00048-12	1.260	4.882	0.012	1.890	-6°	-6°	SNM..43..	0.530
PSC40-DSDNN00050-12	1.575	5.512	0.012	1.969	-6°	-6°	SNM..43..	0.770
PSC50-DSDNN00060-12	1.969	6.496	0.012	2.362	-6°	-6°	SNM..43..	1.655
PSC63-DSDNN00065-12	2.480	7.480	0.012	2.559	-6°	-6°	SNM..43..	2.360
PSC50-DSDNN00060-15	1.969	6.496	0.020	2.362	-6°	-6°	SNM..54..	1.655
PSC63-DSDNN00065-15	2.480	7.480	0.020	2.559	-6°	-6°	SNM..54..	2.360
PSC50-DSDNN00065-19	1.969	6.693	0.020	2.559	-6°	-6°	SNM..64..	1.765
PSC63-DSDNN00070-19	2.480	7.677	0.020	2.756	-6°	-6°	SNM..64..	2.780

Reference							Nm
PSC...-12	1766	ISSN-442	2712	1696	4295	5004	3.5
PSC...-15	1768	ISSN-533	2716	1696	4295	5004	3.5
PSC...-19	1770	ISSN-633	2719	1696	4295	5004	3.5

Optional clamping systems



Reference							Nm
PSC...-12	2613	1086	5003	ISSN-442	1657	5025	3.0
PSC...-15	2614	1086	5003	ISSN-533	1673	5003	3.0
PSC...-19	2614	1086	5003	ISSN-633	1674	5004	3.0



Reference							Nm
PSC...-12-4	1766	ISSN-442	9414	2713	1086	5003	3.0
PSC...-12-7	1766	ISSN-422	9414	2713	1086	5003	3.0





Characteristics:
Toolholder for face turning applications equipped with square negative inserts. PSC with internal coolant.

- 1) γ = Rake angle (valid with a flat insert).
- 2) λ_s = Angle of inclination.

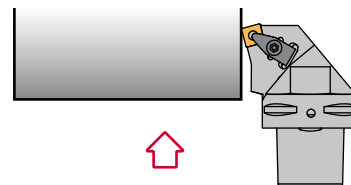
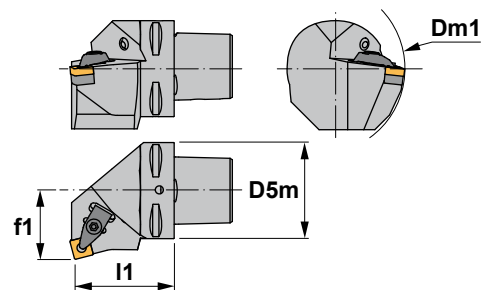

DSKN 75°

Reference	D5m	Dm1 min.	f1	l1	γ^1	λ_s^2	Insert size	
PSC32-DSKNR/L22040-12	1.260	2.362	0.866	1.575	-6°	-6°	SNM..43..	0.465
PSC40-DSKNR/L27050-12	1.575	4.331	1.063	1.969	-6°	-6°	SNM..43..	0.930
PSC50-DSKNR/L35060-12	1.969	4.331	1.378	2.362	-6°	-6°	SNM..43..	1.765
PSC63-DSKNR/L45065-12	2.480	4.331	1.772	2.559	-6°	-6°	SNM..43..	2.425
PSC50-DSKNR/L35060-15	1.969	4.921	1.378	2.362	-6°	-6°	SNM..54..	1.765
PSC63-DSKNR/L45065-15	2.480	4.921	1.772	2.559	-6°	-6°	SNM..54..	2.425
PSC50-DSKNR/L35060-19	1.969	4.921	1.378	2.362	-6°	-6°	SNM..64..	1.765
PSC63-DSKNR/L45065-19	2.480	4.921	1.772	2.559	-6°	-6°	SNM..64..	2.425
PSC80-DSKNR/L55080-19	3.150	4.921	2.165	3.150	-6°	-6°	SNM..64..	6.040

Reference							Nm
PSC...-12	1766	ISSN-442	2712	1696	4295	5004	3.5
PSC...-15	1768	ISSN-533	2716	1696	4295	5004	3.5
PSC...-19	1770	ISSN-633	2719	1696	4295	5004	3.5

Optional clamping systems



M CLAMPING

Reference							Nm
PSC...-12	2613	1086	5003	ISSN-442	1657	5025	3.0
PSC...-15	2614	1086	5003	ISSN-533	1673	5003	3.0
PSC...-19	2614	1086	5003	ISSN-633	1674	5004	3.0



C CLAMPING

Reference							Nm
PSC...-12-4	1766	ISSN-442	9414	2713	1086	5003	3.0
PSC...-12-7	1766	ISSN-422	9414	2713	1086	5003	3.0



Characteristics:

Toolholder for face turning applications equipped with square negative inserts. PSC with internal coolant.

- 1) γ = Rake angle (valid with a flat insert).
- 2) λ_s = Angle of inclination.

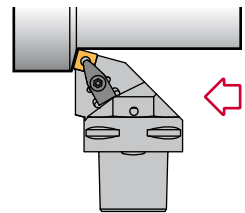
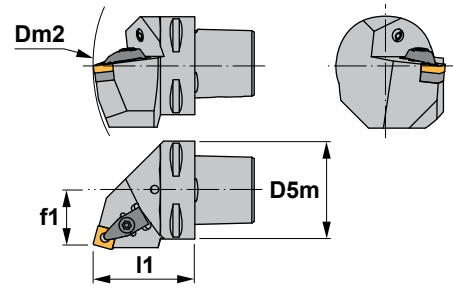

DSRN 75°

Reference	D5m	Dm2 min.	f1	l1	γ^1	λ_s^2	Insert size	
PSC32-DSRNR/L19048-12	1.260	4.882	0.748	1.890	-6°	-6°	SNM..43..	0.575
PSC40-DSRNR/L22050-12	1.575	5.512	0.866	1.969	-6°	-6°	SNM..43..	0.930
PSC50-DSRNR/L27060-12	1.969	6.496	1.063	2.362	-6°	-6°	SNM..43..	1.765
PSC63-DSRNR/L35065-12	2.480	7.480	1.378	2.559	-6°	-6°	SNM..43..	3.085
PSC50-DSRNR/L27060-15	1.969	6.496	1.063	2.362	-6°	-6°	SNM..54..	1.765
PSC63-DSRNR/L35065-15	2.480	7.480	1.378	2.559	-6°	-6°	SNM..54..	3.085
PSC50-DSRNR/L27060-19	1.969	6.496	1.063	2.362	-6°	-6°	SNM..64..	1.765
PSC63-DSRNR/L35065-19	2.480	7.480	1.378	2.559	-6°	-6°	SNM..64..	3.085
PSC80-DSRNR/L45080-19	3.150	9.843	1.772	3.150	-6°	-6°	SNM..64..	6.170

Reference							Nm
PSC...-12	1766	ISSN-442	2712	1696	4295	5004	3.5
PSC...-15	1768	ISSN-533	2716	1696	4295	5004	3.5
PSC...-19	1770	ISSN-633	2719	1696	4295	5004	3.5

Optional clamping systems



M CLAMPING

Reference							Nm
PSC...-12	2613	1086	5003	ISSN-442	1657	5025	3.0
PSC...-15	2614	1086	5003	ISSN-533	1673	5003	3.0
PSC...-19	2614	1086	5003	ISSN-633	1674	5004	3.0



C CLAMPING

Reference							Nm
PSC...-12-4	1766	ISSN-442	9414	2713	1086	5003	3.0
PSC...-12-7	1766	ISSN-422	9414	2713	1086	5003	3.0





Characteristics:
 Toolholder for external turning and chamfering applications equipped with square negative inserts.
 PSC with internal coolant.

- 1) γ = Rake angle (valid with a flat insert).
- 2) λ_s = Angle of inclination.

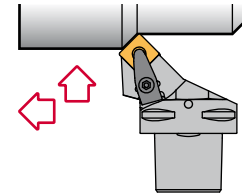
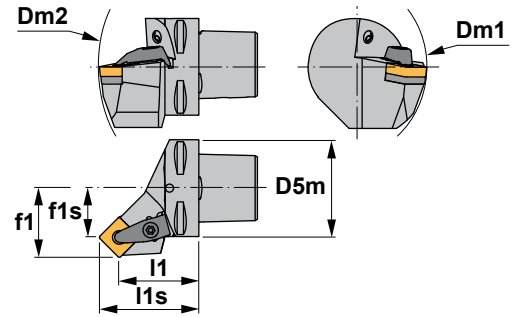

DSSN 45°

Reference	D5m	Dm1 min.	Dm2 min.	f1	f1s	l1	l1s	γ^1 λ_s^2	Insert size	lbs
PSC32-DSSNR/L22040-12	1.260	2.362	4.882	0.866	0.539	1.575	1.901	-8° 0°	SNM..43..	0.465
PSC40-DSSNR/L27042-12	1.575	4.331	5.512	1.063	0.735	1.654	1.981	-8° 0°	SNM..43..	0.770
PSC50-DSSNR/L35052-12	1.969	4.331	6.496	1.378	1.050	2.047	2.375	-8° 0°	SNM..43..	1.545
PSC63-DSSNR/L45056-12	2.480	4.331	7.480	1.772	1.444	2.205	2.532	-8° 0°	SNM..43..	2.470
PSC40-DSSNR/L27045-15	1.575	4.921	5.709	1.063	0.661	1.772	2.173	-8° 0°	SNM..54..	0.880
PSC50-DSSNR/L35050-15	1.969	4.921	6.496	1.378	0.975	1.969	2.372	-8° 0°	SNM..54..	1.500
PSC63-DSSNR/L45054-15	2.480	4.921	7.480	1.772	1.369	2.126	2.529	-8° 0°	SNM..54..	2.515
PSC50-DSSNR/L35048-19	1.969	4.921	6.496	1.378	0.885	1.890	2.381	-8° 0°	SNM..64..	1.545
PSC63-DSSNR/L45052-19	2.480	4.921	7.480	1.772	1.280	2.047	2.539	-8° 0°	SNM..64..	2.490

Reference							Nm
PSC...-12	1766	ISSN-442	2712	1696	4295	5004	3.5
PSC...-15	1768	ISSN-533	2716	1696	4295	5004	3.5
PSC...-19	1770	ISSN-633	2719	1696	4295	5004	3.5

Optional clamping systems



M CLAMPING

Reference							Nm
PSC...-12	2613	1086	5003	ISSN-442	1657	5025	3.0
PSC...-15	2614	1086	5003	ISSN-533	1673	5003	3.0
PSC...-19	2614	1086	5003	ISSN-633	1674	5004	3.0

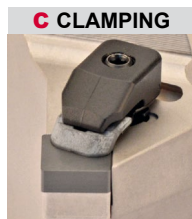

C CLAMPING

Reference							Nm
PSC...-12-4	1766	ISSN-442	9414	2713	1086	5003	3.0
PSC...-12-7	1766	ISSN-422	9414	2713	1086	5003	3.0



Characteristics:
 Toolholder for face turning applications equipped with triangular negative inserts. PSC with internal coolant.

- 1) γ = Rake angle (valid with a flat insert).
- 2) λ_s = Angle of inclination.

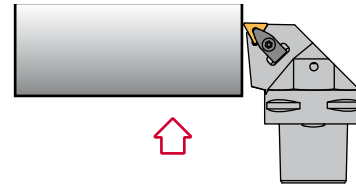
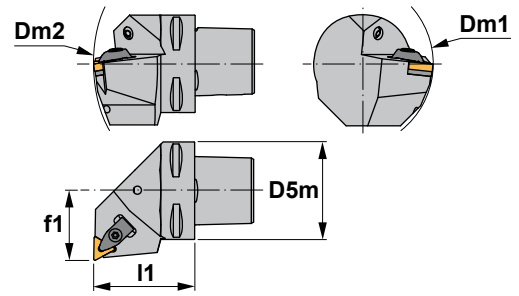

DTFN 90°

Reference	D5m	Dm1 min.	Dm2 min.	f1	l1	γ^1	λ_s^2	Insert size	
PSC40-DTFNR/L27050-16	1.575	4.331	5.512	1.063	1.969	-6°	-6°	TNM..33..	0.930
PSC50-DTFNR/L35060-16	1.969	4.331	6.496	1.378	2.362	-6°	-6°	TNM..33..	1.765
PSC63-DTFNR/L45065-16	2.480	4.331	7.480	1.772	2.559	-6°	-6°	TNM..33..	2.425
PSC40-DTFNR/L27050-22	1.575	4.331	5.512	1.063	1.969	-6°	-6°	TNM..43..	0.930
PSC50-DTFNR/L35060-22	1.969	4.331	6.496	1.378	2.362	-6°	-6°	TNM..43..	1.765
PSC63-DTFNR/L45065-22	2.480	4.331	7.480	1.772	2.559	-6°	-6°	TNM..43..	2.425

Reference							Nm
PSC40-DTFNR/L27050-16	1764	ITSN-342	2708	1695	4294	5004	3.5
PSC50-DTFNR/L35060-16	1764	ITSN-342	2708	1695	4294	5004	3.5
PSC63-DTFNR/L45065-16	1764	ITSN-342	2708	1695	4294	5004	3.5
PSC40-DTFNR/L27050-22	1766	ITSN-443	2712	1696	4295	5004	3.5
PSC50-DTFNR/L35060-22	1766	ITSN-443	2712	1696	4295	5004	3.5
PSC63-DTFNR/L45065-22	1766	ITSN-443	2712	1696	4295	5004	3.5

Optional clamping systems



Reference							Nm
PSC...-16	2604	1085	5025	ITSN-342	1675	5002	2.0





Characteristics:
 Toolholder for external turning applications equipped with triangular negative inserts. PSC with internal coolant.

- 1) γ = Rake angle (valid with a flat insert).
- 2) λ_s = Angle of inclination.

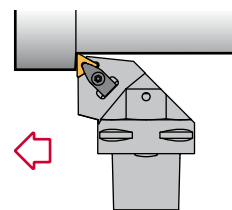
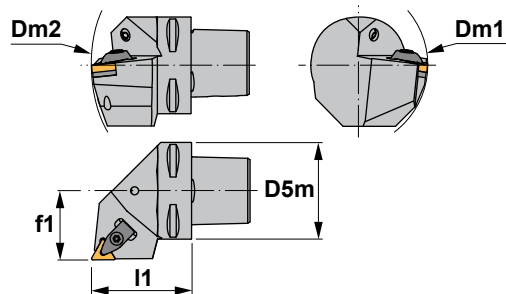

DTGN 90°

Reference	D5m	Dm1 min.	Dm2 min.	f1	l1	γ^1	λ_s^2	Insert size	lbs
PSC40-DTGNR/L27050-16	1.575	4.331	5.512	1.063	1.969	-6°	-6°	TNM..33..	0.930
PSC50-DTGNR/L35060-16	1.969	4.331	6.496	1.378	2.362	-6°	-6°	TNM..33..	1.765
PSC63-DTGNR/L45065-16	2.480	4.331	7.480	1.772	2.559	-6°	-6°	TNM..33..	2.425
PSC40-DTGNR/L27050-22	1.575	4.331	5.512	1.063	1.969	-6°	-6°	TNM..43..	0.930
PSC50-DTGNR/L35060-22	1.969	4.331	6.496	1.378	2.362	-6°	-6°	TNM..43..	1.765
PSC63-DTGNR/L45065-22	2.480	4.331	7.480	1.772	2.559	-6°	-6°	TNM..43..	2.425

Reference							Nm
PSC40-DTGNR/L27050-16	1764	ITSN-342	2708	1695	4294	5004	3.5
PSC50-DTGNR/L35060-16	1764	ITSN-342	2708	1695	4294	5004	3.5
PSC63-DTGNR/L45065-16	1764	ITSN-342	2708	1695	4294	5004	3.5
PSC40-DTGNR/L27050-22	1766	ITSN-433	2712	1696	4295	5004	3.5
PSC50-DTGNR/L35060-22	1766	ITSN-433	2712	1696	4295	5004	3.5
PSC63-DTGNR/L45065-22	1766	ITSN-433	2712	1696	4295	5004	3.5

Optional clamping systems



M CLAMPING

Reference						Nm
PSC...-16	2604	1085	5025	ITSN-342	1675 5002	2.0



Characteristics:
 Toolholder for very specific operations equipped with rhombic negative inserts (angle 35°).
 PSC with internal coolant.

- 1) γ = Rake angle (valid with a flat insert).
- 2) λ_s = Angle of inclination.

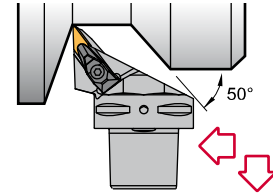
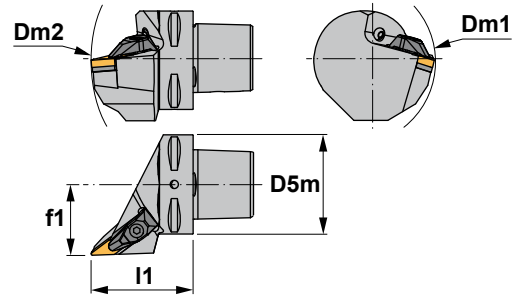

DVJN 93°

Reference	D5m	Dm1 min.	Dm2 min.	f1	l1	γ^1	λ_s^2	Insert size	
PSC40-DVJNR/L27062-16	1.575	2.362	5.984	1.063	2.441	-4°	-13°	VN..33..	0.990
PSC50-DVJNR/L35065-16	1.969	2.559	6.693	1.378	2.559	-4°	-13°	VN..33..	1.740
PSC63-DVJNR/L45065-16	2.480	3.189	7.480	1.772	2.559	-4°	-13°	VN..33..	2.425
PSC80-DVJNR/L55080-16	3.150	3.937	9.843	2.165	3.150	-4°	-13°	VN..33..	6.040

Reference							Nm
PSC40-DVJNR/L27062-16	1764	IVSN-322	2708	1695	4294	5004	3.5
PSC50-DVJNR/L35065-16	1764	IVSN-322	2708	1695	4294	5004	3.5
PSC63-DVJNR/L45065-16	1764	IVSN-322	2708	1695	4294	5004	3.5
PSC80-DVJNR/L55080-16	1764	IVSN-322	2708	1695	4294	5004	3.5

Optional clamping systems



M CLAMPING

Reference							Nm
PSC...-16	2604	1085	5025	IVSN-322	1665	5002	2.0







Characteristics:



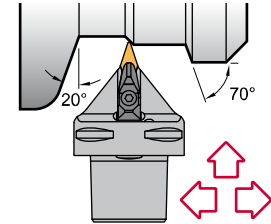
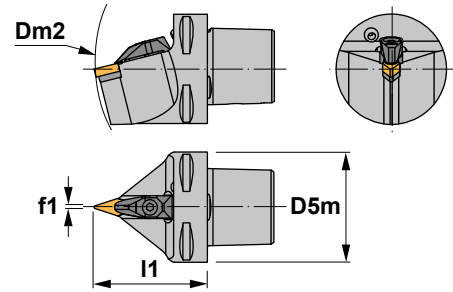

Profiling toolholder equipped with rhombic negative double-sided insert (angle 35°). PSC with internal coolant.

- 1) γ = Rake angle (valid with a flat insert).
- 2) λ_s = Angle of inclination.



DVVN 72° 30'



Reference	D5m	Dm2 min.	f1	l1	γ^1	λ_s^2	Insert size	
PSC40-DVVNN00062-16	1.575	5.984	0.024	2.441	-4°	-13°	VN..33..	0.950
PSC50-DVVNN00065-16	1.969	6.693	0.024	2.559	-4°	-13°	VN..33..	1.765
PSC63-DVVNN00065-16	2.480	7.480	0.024	2.559	-4°	-13°	VN..33..	2.360
PSC80-DVVNN00080-16	3.150	9.843	0.024	3.150	-4°	-13°	VN..33..	5.115

Reference							Nm
PSC40-DVVNN00062-16	1764	IVSN-322	2708	1695	4294	5004	3.5
PSC50-DVVNN00065-16	1764	IVSN-322	2708	1695	4294	5004	3.5
PSC63-DVVNN00065-16	1764	IVSN-322	2708	1695	4294	5004	3.5
PSC80-DVVNN00080-16	1764	IVSN-322	2708	1695	4294	5004	3.5

Optional clamping systems

M CLAMPING



Reference							Nm
PSC...-16	2604	1085	5025	IVSN-322	1665	5002	2.0



Characteristics:
 Multipurpose toolholder equipped with trigon negative double-sided insert (angle 80°).
 PSC with internal coolant.

- 1) γ = Rake angle (valid with a flat insert).
- 2) λ_s = Angle of inclination.

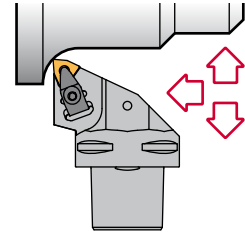
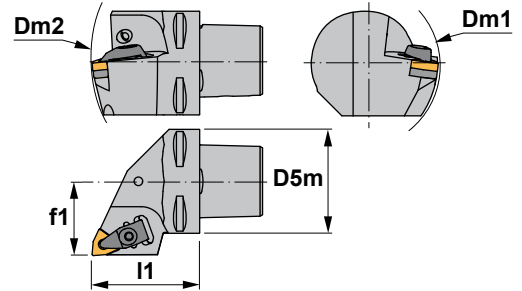

DWLN 95°

Reference	D5m	Dm1 min.	Dm2 min.	f1	l1	$\gamma^1)$	$\lambda_s^2)$	Insert size	lbs
PSC32-DWLN/L22040-06	1.260	2.362	4.567	0.866	1.575	-6°	-6°	WNMG33..	0.465
PSC40-DWLN/L27050-06	1.575	2.362	5.512	1.063	1.969	-6°	-6°	WNMG33..	0.930
PSC50-DWLN/L35060-06	1.969	2.559	6.496	1.378	2.362	-6°	-6°	WNMG33..	1.765
PSC63-DWLN/L45065-06	2.480	3.189	7.480	1.772	2.559	-6°	-6°	WNMG33..	2.425
PSC40-DWLN/L27050-08	1.575	4.331	5.512	1.063	1.969	-6°	-6°	WNMG43..	0.930
PSC50-DWLN/L35060-08	1.969	4.331	6.496	1.378	2.362	-6°	-6°	WNMG43..	1.765
PSC63-DWLN/L45065-08	2.480	4.331	7.480	1.772	2.559	-6°	-6°	WNMG43..	2.425
PSC80-DWLN/L55080-08	3.150	4.331	9.843	2.165	3.150	-6°	-6°	WNMG43..	6.040

Reference							Nm
PSC32-DWLN/L22040-06	1764	IWSN-322	2708	1695	4294	5004	3.5
PSC40-DWLN/L27050-06	1764	IWSN-322	2708	1695	4294	5004	3.5
PSC50-DWLN/L35060-06	1764	IWSN-322	2708	1695	4294	5004	3.5
PSC63-DWLN/L45065-06	1764	IWSN-322	2708	1695	4294	5004	3.5
PSC40-DWLN/L27050-08	1766	IWSN-433	2712	1696	4295	5004	3.5
PSC50-DWLN/L35060-08	1766	IWSN-433	2712	1696	4295	5004	3.5
PSC63-DWLN/L45065-08	1766	IWSN-433	2712	1696	4295	5004	3.5
PSC80-DWLN/L55080-08	1766	IWSN-433	2712	1696	4295	5004	3.5

WNMG

80° trigon negative inserts. A42-43

Reference	l	T	d
WNMG33..	0.241	0.187	0.375
WNMG43..	0.320	0.187	0.500

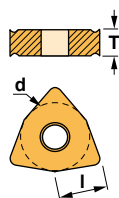



Characteristics:
 Multipurpose toolholder equipped with rhombic negative double-sided insert (angle 80°). PSC with internal coolant.
 1) γ = Rake angle (valid with a flat insert).
 2) λ_s = Angle of inclination.

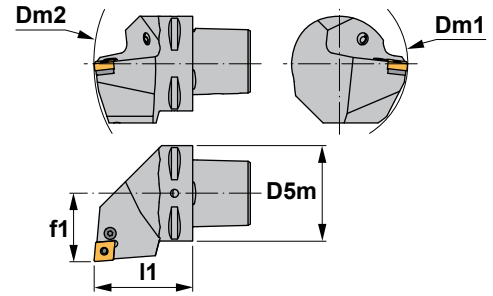
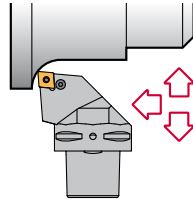

PCLN 95°

Reference	D5m	Dm1 min.	Dm2 min.	f1	l1	γ^1	λ_s^2	Insert size	
PSC32-PCLNR/L22040-12	1.260	2.362	4.882	0.866	1.575	-6°	-6°	CN..43..	0.465
PSC40-PCLNR/L27050-12	1.575	4.331	5.512	1.063	1.969	-6°	-6°	CN..43..	0.930
PSC50-PCLNR/L35060-12	1.969	4.331	6.496	1.378	2.362	-6°	-6°	CN..43..	1.765
PSC63-PCLNR/L45065-12	2.480	4.331	7.480	1.772	2.559	-6°	-6°	CN..43..	2.425
PSC80-PCLNR/L55080-12	3.150	4.331	9.843	2.165	3.150	-6°	-6°	CN..43..	6.040
PSC40-PCLNR/L27050-16	1.575	4.921	5.512	1.063	1.969	-6°	-6°	CN..54..	0.930
PSC50-PCLNR/L35060-16	1.969	4.921	6.496	1.378	2.362	-6°	-6°	CN..54..	1.765
PSC63-PCLNR/L45065-16	2.480	4.921	7.480	1.772	2.559	-6°	-6°	CN..54..	2.425
PSC80-PCLNR/L55080-16	3.150	4.921	9.843	2.165	3.150	-6°	-6°	CN..54..	6.040
PSC50-PCLNR/L35060-19	1.969	4.921	6.496	1.378	2.362	-6°	-6°	CN..64..	1.765
PSC63-PCLNR/L45065-19	2.480	4.921	7.480	1.772	2.559	-6°	-6°	CN..64..	2.425
PSC80-PCLNR/L55080-19	3.150	4.921	9.843	2.165	3.150	-6°	-6°	CN..64..	6.040
PSC80-PCLNR/L55080-25	3.150	5.906	9.843	2.165	3.150	-6°	-6°	CN..2509..	6.040

Reference							Nm
PSC32-PCLNR/L22040-12	8012	1608	5003	3612	4112	0012	3.0
PSC40-PCLNR/L27050-12	8012	1608	5003	3612	4112	0012	3.0
PSC50-PCLNR/L35060-12	8012	1608	5003	3612	4112	0012	3.0
PSC63-PCLNR/L45065-12	8012	1608	5003	3612	4112	0012	3.0
PSC80-PCLNR/L55080-12	8012	1608	5003	3612	4112	0012	3.0
PSC40-PCLNR/L27050-16	8016	1618	5003	3616	4115	0015	3.0
PSC50-PCLNR/L35060-16	8016	1618	5003	3616	4115	0015	3.0
PSC63-PCLNR/L45065-16	8016	1618	5003	3616	4115	0015	3.0
PSC80-PCLNR/L55080-16	8016	1618	5003	3616	4115	0015	3.0
PSC50-PCLNR/L35060-19	8019	1610	5004	3619	4119	0019	3.5
PSC63-PCLNR/L45065-19	8019	1610	5004	3619	4119	0019	3.5
PSC80-PCLNR/L55080-19	8019	1610	5004	3619	4119	0019	3.5
PSC80-PCLNR/L55080-25	8025	1612	5005	3625	4125	0025	4.0

CN.. 80° rhombic negative inserts. A24-26

Reference	l	T	d
CN..43..	0.508	0.187	0.500
CN..54..	0.633	0.250	0.625
CN..64..	0.763	0.250	0.750
CN..2509..	1.015	0.375	1.000

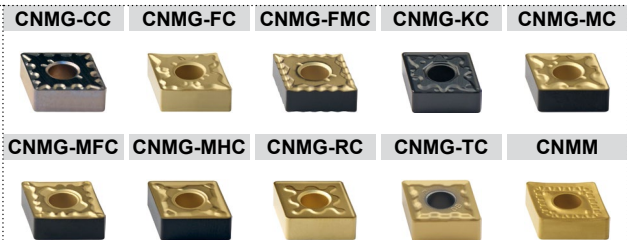
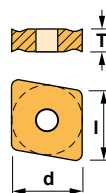

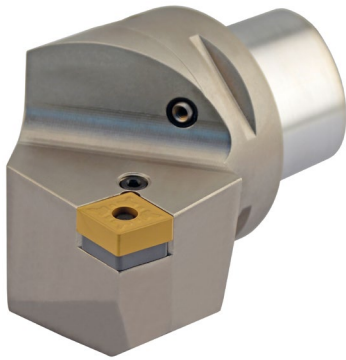

Characteristics:
 Multipurpose toolholder equipped with rhombic negative double-sided insert (angle 80°).
 PSC with internal coolant.

- 1) γ = Rake angle (valid with a flat insert).
- 2) λ_s = Angle of inclination.

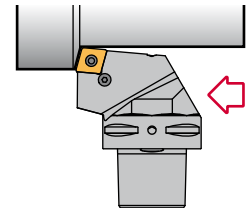
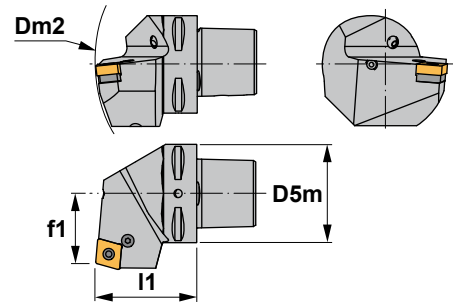

PCRN 75°

Reference	D5m	Dm2 min.	f1	l1	$\gamma^1)$	$\lambda_s^2)$	Insert size	
PSC50-PCRN/L27060-12	1.969	6.496	1.063	2.362	-6°	-6°	CN..43..	1.765
PSC63-PCRN/L35065-12	2.480	7.480	1.378	2.559	-6°	-6°	CN..43..	3.085
PSC50-PCRN/L27060-16	1.969	6.496	1.063	2.362	-6°	-6°	CN..54..	1.765
PSC63-PCRN/L35065-16	2.480	7.480	1.378	2.559	-6°	-6°	CN..54..	3.085
PSC50-PCRN/L27060-19	1.969	6.496	1.063	2.362	-6°	-6°	CN..64..	1.765
PSC63-PCRN/L35065-19	2.480	7.480	1.378	2.559	-6°	-6°	CN..64..	3.085

Reference							Nm
PSC50-PCRN/L27060-12	8012	1608	5003	3612	4112	0012	3.0
PSC63-PCRN/L35065-12	8012	1608	5003	3612	4112	0012	3.0
PSC50-PCRN/L27060-16	8016	1618	5003	3616	4115	0015	3.0
PSC63-PCRN/L35065-16	8016	1618	5003	3616	4115	0015	3.0
PSC50-PCRN/L27060-19	8019	1610	5004	3619	4119	0019	3.5
PSC63-PCRN/L35065-19	8019	1610	5004	3619	4119	0019	3.5

CN.. 80° rhombic negative inserts. A24-26

Reference	l	T	d
CN..43..	0.508	0.187	0.500
CN..54..	0.633	0.250	0.625
CN..64..	0.763	0.250	0.750

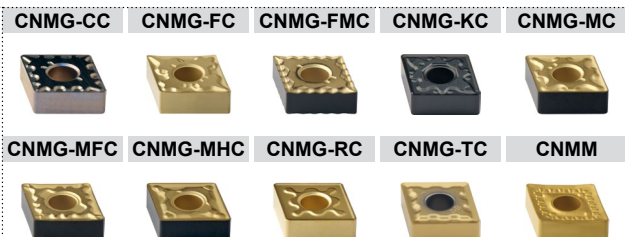
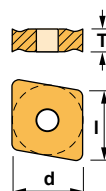



Characteristics:
 Turning and profiling toolholder equipped with rhombic negative double-sided insert (angle 55°).
 PSC with internal coolant.

1) γ = Rake angle (valid with a flat insert).
 2) λ_s = Angle of inclination.

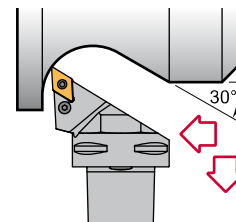
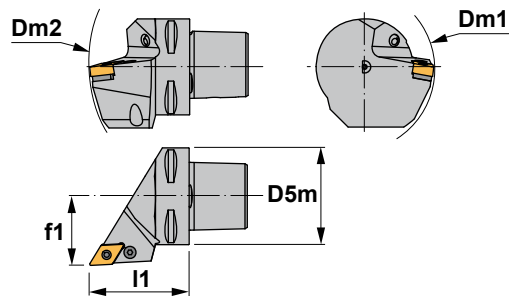

PDJN 93°

Reference	D5m	Dm1 min.	Dm2 min.	f1	l1	γ^1	λ_s^2	Insert size	lbs
PSC50-PDJNR/L35060-11	1.969	4.331	6.496	1.378	2.362	-6°	-7°	DN..33..	1.765
PSC40-PDJNR/L27055-15	1.575	4.331	5.709	1.063	2.165	-6°	-7°	DN..44..	0.950
PSC50-PDJNR/L35060-15	1.969	4.331	6.496	1.378	2.362	-6°	-7°	DN..44..	1.765
PSC63-PDJNR/L45065-15	2.480	4.331	7.480	1.772	2.559	-6°	-7°	DN..44..	2.425
PSC80-PDJNR/L55080-15	3.150	4.331	9.843	2.165	3.150	-6°	-7°	DN..44..	6.040

Reference								Nm
PSC50-PDJNR/L35060-11	8009	1606	5025	3711	4109	0009	- -	2.0
PSC40-PDJNR/L27055-15	8415	1638	5003	3715	4112	0012	3725 4135	3.0
PSC50-PDJNR/L35060-15	8415	1638	5003	3715	4112	0012	3725 4135	3.0
PSC63-PDJNR/L45065-15	8415	1638	5003	3715	4112	0012	3725 4135	3.0
PSC80-PDJNR/L55080-15	8415	1638	5003	3715	4112	0012	3725 4135	3.0

For inserts DN..43..

DN..

55° rhombic negative inserts. A28-30

Reference	l	T	d
DN..33..	0.457	0.187	0.375
DN..43..	0.610	0.187	0.500
DN..44..	0.610	0.250	0.500

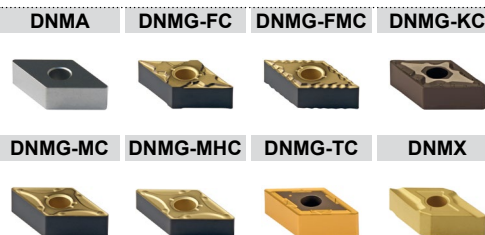
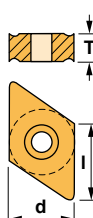



Characteristics:
 Turning and profiling toolholder equipped with rhombic negative double-sided insert (angle 55°).
 PSC with internal coolant.

- 1) γ = Rake angle (valid with a flat insert).
- 2) λ_s = Angle of inclination.

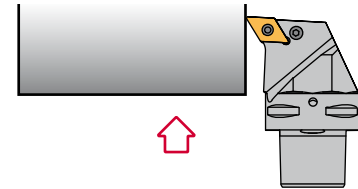
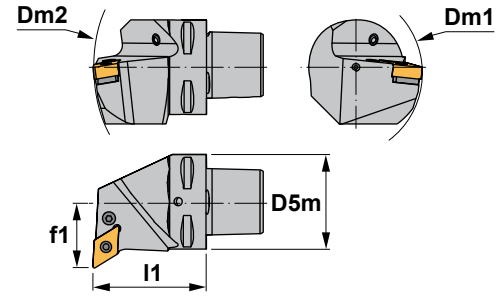

PDUN 93°

Reference	D5m	Dm1 min.	Dm2 min.	f1	l1	γ^1	λ_s^2	Insert size	
PSC40-PDUNR/L27050-15	1.575	4.331	5.512	1.063	1.969	-6°	-7°	DN..44..	0.930
PSC50-PDUNR/L35060-15	1.969	4.331	6.496	1.378	2.362	-6°	-7°	DN..44..	1.765
PSC63-PDUNR/L45065-15	2.480	4.331	7.480	1.772	2.559	-6°	-7°	DN..44..	2.425
PSC80-PDUNR/L55080-15	3.150	4.331	9.843	2.165	3.150	-6°	-7°	DN..44..	6.040

Reference									Nm
PSC40-PDUNR/L27050-15	8415	1638	5003	3715	4112	0012	3725	4135	3.0
PSC50-PDUNR/L35060-15	8415	1638	5003	3715	4112	0012	3725	4135	3.0
PSC63-PDUNR/L45065-15	8415	1638	5003	3715	4112	0012	3725	4135	3.0
PSC80-PDUNR/L55080-15	8415	1638	5003	3715	4112	0012	3725	4135	3.0

For inserts DN..43..

DN..		55° rhombic negative inserts. A28-30		
Reference	l	T	d	
DN..43..	0.610	0.187	0.500	
DN..44..	0.610	0.250	0.500	

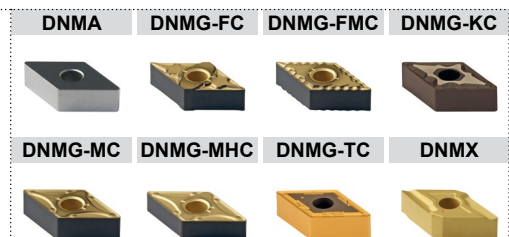



Characteristics:
 Profiling toolholder equipped with round positive insert. PSC with internal coolant.

- 1) γ = Rake angle (valid with a flat insert).
- 2) $\lambda.s$ = Angle of inclination.

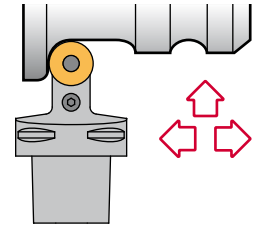
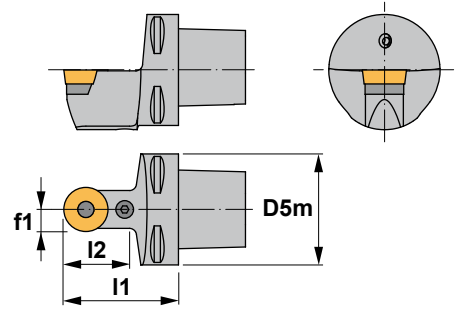

PRDC

Reference	D5m	f1	l1	l2	$\gamma^{(1)}$	$\lambda.s^{(2)}$	Insert size	
PSC63-PRDCN00065-25	2.480	0.492	2.559	1.575	0°	0°	RC..2507M0	2.360
PSC80-PRDCN00080-25	3.150	0.492	3.150	1.575	0°	0°	RC..2507M0	5.115
PSC80-PRDCN00080-32	3.150	0.630	3.150	1.772	0°	0°	RC..3209M0	5.115

Reference							Nm
PSC63-PRDCN00065-25	8125	1710	5004	3825	4119	0019	3.5
PSC80-PRDCN00080-25	8125	1710	5004	3825	4119	0019	3.5
PSC80-PRDCN00080-32	8132	1612	5005	3832	4125	0025	4.0

RC..

Round positive inserts with 7° clearance. A31

Reference	T	d
RC..2507M0	0.312	0.984
RC..3209M0	0.375	1.260

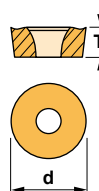

RCGT-AL



RCGT-AP



RCMT





Characteristics:
Profiling toolholder equipped with round positive insert. PSC with internal coolant.

- 1) γ = Rake angle (valid with a flat insert).
- 2) λ_s = Angle of inclination.

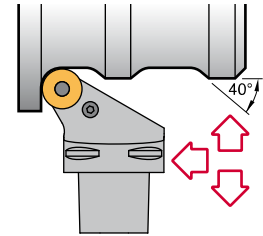
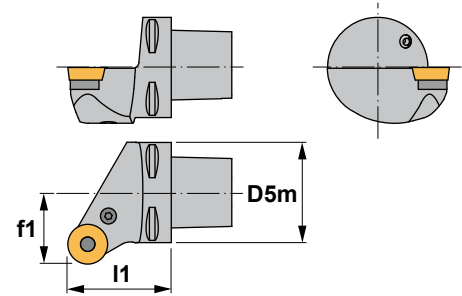

PRSC

Reference	D5m	f1	l1	γ^1	λ_s^2	Insert size	
PSC80-PRSCR/L55080-20	3.150	2.165	3.150	0°	0°	RC..2006M0	6.040
PSC63-PRSCR/L45065-25	2.480	1.772	2.559	0°	0°	RC..2507M0	2.425
PSC80-PRSCR/L55080-25	3.150	2.165	3.150	0°	0°	RC..2507M0	6.040
PSC80-PRSCR/L55080-32	3.150	2.165	3.150	0°	0°	RC..3209M0	6.040

Reference							Nm
PSC80-PRSCR/L55080-20	8120	1708	5003	3820	4115	0015	3.0
PSC63-PRSCR/L45065-25	8125	1710	5004	3825	4119	0019	3.5
PSC80-PRSCR/L55080-25	8125	1710	5004	3825	4119	0019	3.5
PSC80-PRSCR/L55080-32	8132	1612	5005	3832	4125	0025	4.0

RC..

Round positive inserts with 7° clearance. A31

Reference	T	d
RC..2006M0	0.250	0.787
RC..2507M0	0.312	1.000
RC..3209M0	0.375	1.260

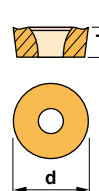

RCGT-AL

RCGT-AP



RCMT





Characteristics:

Toolholder for external turning and chamfering applications equipped with square negative inserts.

PSC with internal coolant.

1) γ = Rake angle (valid with a flat insert).

2) λ_s = Angle of inclination.

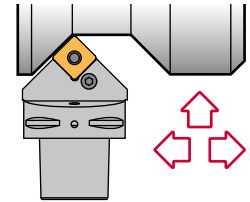
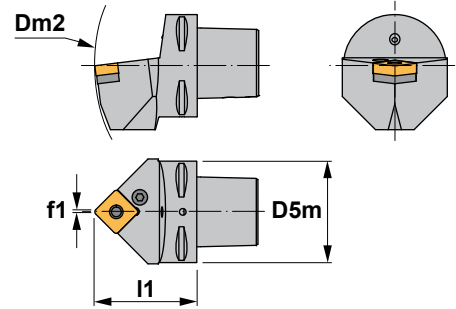

PSDN 45°

Reference	D5m	Dm2 min.	f1	I1	γ^1	λ_s^2	Insert size	
PSC40-PSDNN00050-12	1.575	5.512	0.012	1.969	-6°	-6°	SNM..43..	0.770
PSC50-PSDNN00060-12	1.969	6.496	0.012	2.362	-6°	-6°	SNM..43..	1.655
PSC63-PSDNN00065-12	2.480	7.480	0.012	2.559	-6°	-6°	SNM..43..	2.360
PSC40-PSDNN00050-15	1.575	5.512	0.020	1.969	-6°	-6°	SNM..54..	0.770
PSC50-PSDNN00060-15	1.969	6.496	0.020	2.362	-6°	-6°	SNM..54..	1.655
PSC63-PSDNN00065-15	2.480	7.480	0.020	2.559	-6°	-6°	SNM..54..	2.360
PSC50-PSDNN00060-19	1.969	6.693	0.020	2.362	-6°	-6°	SNM..64..	1.655
PSC63-PSDNN00065-19	2.480	7.677	0.020	2.559	-6°	-6°	SNM..64..	2.360
PSC63-PSDNN00065-25	2.480	7.677	0.039	2.559	-6°	-6°	SNM..85..	2.360
PSC80-PSDNN00080-25	3.150	9.843	0.039	3.150	-6°	-6°	SNM..85..	5.115

Reference							Nm
PSC40-PSDNN00050-12	8012	1608	5003	3512	4112	0012	3.0
PSC50-PSDNN00060-12	8012	1608	5003	3512	4112	0012	3.0
PSC63-PSDNN00065-12	8012	1608	5003	3512	4112	0012	3.0
PSC40-PSDNN00050-15	8016	1618	5003	3515	4115	0015	3.0
PSC50-PSDNN00060-15	8016	1618	5003	3515	4115	0015	3.0
PSC63-PSDNN00065-15	8016	1618	5003	3515	4115	0015	3.0
PSC50-PSDNN00060-19	8019	1610	5004	3519	4119	0019	3.5
PSC63-PSDNN00065-19	8019	1610	5004	3519	4119	0019	3.5
PSC63-PSDNN00065-25	8025	1612	5005	3525	4125	0025	4.0
PSC80-PSDNN00080-25	8025	1612	5005	3525	4125	0025	4.0

SNM..

Square negative inserts. A33-34

Reference	l	T	d
SNM..43..	0.500	0.187	0.500
SNM..54..	0.625	0.250	0.625
SNM..64..	0.750	0.250	0.750
SNM..85..	1.000	0.312	1.000

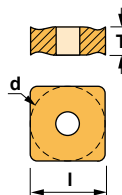

SNMG-FMC



SNMG-KC



SNMG-MHC



SNMG-RC



SNMG-TC



SNMM





Characteristics:
 Toolholder for face turning applications equipped with square negative inserts. PSC with internal coolant.

- 1) γ = Rake angle (valid with a flat insert).
- 2) λ_s = Angle of inclination.

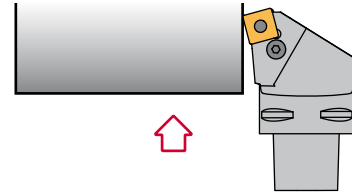
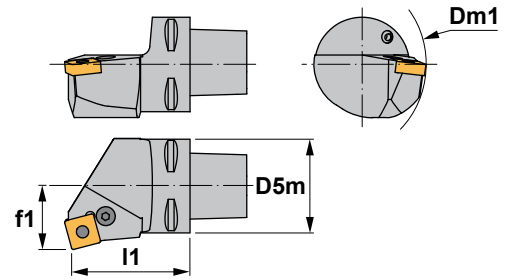

PSKN 75°

Reference	D5m	Dm1 min.	f1	l1	$\gamma^{(1)}$	$\lambda_s^{(2)}$	Insert size	
PSC40-PSKNR/L27050-12	1.575	4.331	1.063	1.969	-6°	-6°	SNM..43..	0.930
PSC50-PSKNR/L35060-12	1.969	4.331	1.378	2.362	-6°	-6°	SNM..43..	1.765
PSC63-PSKNR/L45065-12	2.480	4.331	1.772	2.559	-6°	-6°	SNM..43..	2.425
PSC50-PSKNR/L35060-15	1.969	4.921	1.378	2.362	-6°	-6°	SNM..54..	1.765
PSC63-PSKNR/L45065-15	2.480	4.921	1.772	2.559	-6°	-6°	SNM..54..	2.425
PSC50-PSKNR/L35060-19	1.969	4.921	1.378	2.362	-6°	-6°	SNM..64..	1.765
PSC63-PSKNR/L45065-19	2.480	4.921	1.772	2.559	-6°	-6°	SNM..64..	2.425
PSC80-PSKNR/L55080-19	3.150	4.921	2.165	3.150	-6°	-6°	SNM..64..	6.040
PSC80-PSKNR/L55080-25	3.150	5.906	2.165	3.150	-6°	-6°	SNM..85..	6.040

Reference							Nm
PSC40-PSKNR/L27050-12	8012	1608	5003	3512	4112	0012	3.0
PSC50-PSKNR/L35060-12	8012	1608	5003	3512	4112	0012	3.0
PSC63-PSKNR/L45065-12	8012	1608	5003	3512	4112	0012	3.0
PSC50-PSKNR/L35060-15	8016	1618	5003	3515	4115	0015	3.0
PSC63-PSKNR/L45065-15	8016	1618	5003	3515	4115	0015	3.0
PSC50-PSKNR/L35060-19	8019	1610	5004	3519	4119	0019	3.5
PSC63-PSKNR/L45065-19	8019	1610	5004	3519	4119	0019	3.5
PSC80-PSKNR/L55080-19	8019	1610	5004	3519	4119	0019	3.5
PSC80-PSKNR/L55080-25	8025	1612	5005	3525	4125	0025	4.0

SNM..

Square negative inserts. A33-34

Reference	l	T	d
SNM..43..	0.500	0.187	0.500
SNM..54..	0.625	0.250	0.625
SNM..64..	0.750	0.250	0.750
SNM..85..	1.000	0.312	1.000

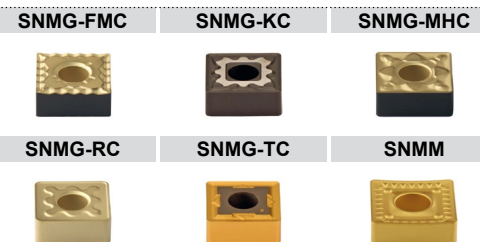
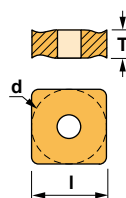



Characteristics:
 Toolholder for face turning applications equipped with square negative inserts. PSC with internal coolant.

- 1) γ = Rake angle (valid with a flat insert).
- 2) λ_s = Angle of inclination.

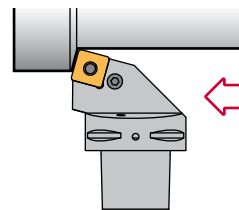
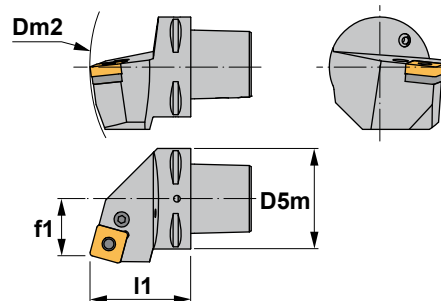

PSRN 75°

Reference	D5m	Dm2 min.	f1	l1	γ 1)	λ_s 2)	Insert size	
PSC32-PSRNR/L17040-12	1.260	4.882	0.669	1.575	-6°	-6°	SNM..43..	0.440
PSC40-PSRNR/L22050-12	1.575	5.512	0.866	1.969	-6°	-6°	SNM..43..	0.930
PSC50-PSRNR/L27060-12	1.969	6.496	1.063	2.362	-6°	-6°	SNM..43..	1.765
PSC63-PSRNR/L35065-12	2.480	7.480	1.378	2.559	-6°	-6°	SNM..43..	3.085
PSC50-PSRNR/L27060-15	1.969	6.496	1.063	2.362	-6°	-6°	SNM..54..	1.765
PSC63-PSRNR/L35065-15	2.480	7.480	1.378	2.559	-6°	-6°	SNM..54..	3.085
PSC50-PSRNR/L27060-19	1.969	6.496	1.063	2.362	-6°	-6°	SNM..64..	1.765
PSC63-PSRNR/L35065-19	2.480	7.480	1.378	2.559	-6°	-6°	SNM..64..	3.085
PSC80-PSRNR/L45080-19	3.150	9.843	1.772	3.150	-6°	-6°	SNM..64..	6.170
PSC80-PSRNR/L45080-25	3.150	9.843	1.772	3.150	-6°	-6°	SNM..85..	6.170

Reference							Nm
PSC32-PSRNR/L17040-12	8012	1608	5003	3512	4112	0012	3.0
PSC40-PSRNR/L22050-12	8012	1608	5003	3512	4112	0012	3.0
PSC50-PSRNR/L27060-12	8012	1608	5003	3512	4112	0012	3.0
PSC63-PSRNR/L35065-12	8012	1608	5003	3512	4112	0012	3.0
PSC50-PSRNR/L27060-15	8016	1618	5003	3515	4115	0015	3.0
PSC63-PSRNR/L35065-15	8016	1618	5003	3515	4115	0015	3.0
PSC50-PSRNR/L27060-19	8019	1610	5004	3519	4119	0019	3.5
PSC63-PSRNR/L35065-19	8019	1610	5004	3519	4119	0019	3.5
PSC80-PSRNR/L45080-19	8019	1610	5004	3519	4119	0019	3.5
PSC80-PSRNR/L45080-25	8025	1612	5005	3525	4125	0025	4.0

SNM..

Square negative inserts. A33-34

Reference	l	T	d
SNM..43..	0.500	0.187	0.500
SNM..54..	0.625	0.250	0.625
SNM..64..	0.750	0.250	0.750
SNM..85..	1.000	0.312	1.000

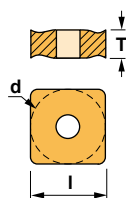

SNMG-FMC SNMG-KC SNMG-MHC



SNMG-RC SNMG-TC SNMM





Characteristics:
 Toolholder for external turning and chamfering applications equipped with square negative inserts.
 PSC with internal coolant.

- 1) γ = Rake angle (valid with a flat insert).
- 2) λ_s = Angle of inclination.

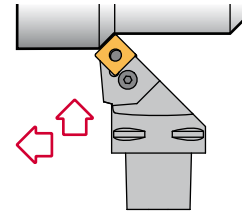
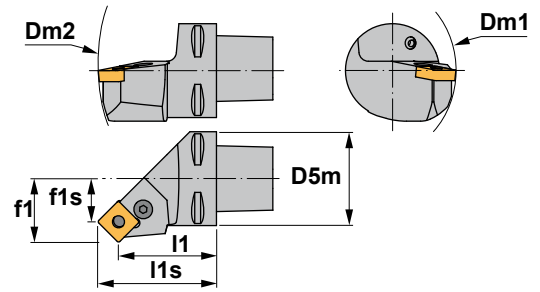

PSSN 45°

Reference	D5m	Dm1 min.	Dm2 min.	f1	f1s	l1	l1s	γ^1	λ_s^2	Insert size	lbs
PSC32-PSSNR/L22032-12	1.260	2.362	4.882	0.866	0.539	1.260	1.586	-8°	0°	SNM..43..	0.400
PSC40-PSSNR/L27042-12	1.575	4.331	5.512	1.063	0.735	1.654	1.981	-8°	0°	SNM..43..	0.770
PSC50-PSSNR/L35052-12	1.969	4.331	6.496	1.378	1.050	2.047	2.375	-8°	0°	SNM..43..	1.545
PSC63-PSSNR/L45056-12	2.480	4.331	7.480	1.772	1.444	2.205	2.532	-8°	0°	SNM..43..	2.470
PSC63-PSSNR/L45054-15	2.480	4.921	7.480	1.772	1.369	2.126	2.529	-8°	0°	SNM..54..	2.515
PSC63-PSSNR/L45052-19	2.480	4.921	7.480	1.772	1.280	2.047	2.539	-8°	0°	SNM..64..	2.490
PSC80-PSSNR/L55070-25	3.150	5.906	10.078	2.165	1.535	2.756	3.385	-8°	0°	SNM..85..	5.780

Reference							Nm
PSC32-PSSNR/L22032-12	8012	1608	5003	3512	4112	0012	3.0
PSC40-PSSNR/L27042-12	8012	1608	5003	3512	4112	0012	3.0
PSC50-PSSNR/L35052-12	8012	1608	5003	3512	4112	0012	3.0
PSC63-PSSNR/L45056-12	8012	1608	5003	3512	4112	0012	3.0
PSC63-PSSNR/L45054-15	8016	1618	5003	3515	4115	0015	3.0
PSC63-PSSNR/L45052-19	8019	1610	5004	3519	4119	0019	3.5
PSC80-PSSNR/L55070-25	8025	1612	5005	3525	4125	0025	4.0

SNM..

Square negative inserts. A33-34

Reference	l	T	d
SNM..43..	0.500	0.187	0.500
SNM..54..	0.625	0.250	0.625
SNM..64..	0.750	0.250	0.750
SNM..85..	1.000	0.312	1.000

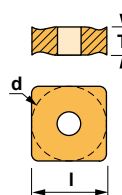

SNMG-FMC SNMG-KC SNMG-MHC



SNMG-RC

SNMG-TC

SNMM





Characteristics:
 Multipurpose toolholder equipped with rhombic positive insert (angle 80°).
 PSC with internal coolant.

- 1) γ = Rake angle (valid with a flat insert).
- 2) λ_s = Angle of inclination.

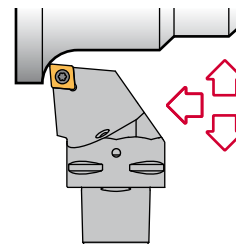
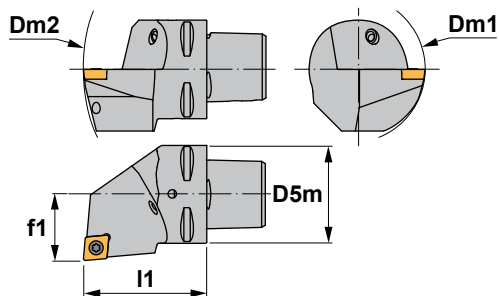

SCLC 95°

Reference	D5m	Dm1 min.	Dm2 min.	f1	l1	γ (1)	λ_s (2)	Insert size	lbs
PSC32-SCLCR/L22040-09	1.260	3.150	4.882	0.866	1.575	0°	0°	CC..32.5..	0.465
PSC40-SCLCR/L27050-09	1.575	3.150	5.512	1.063	1.969	0°	0°	CC..32.5..	0.930
PSC50-SCLCR/L35060-09	1.969	3.150	6.496	1.378	2.362	0°	0°	CC..32.5..	1.765
PSC63-SCLCR/L45065-09	2.480	3.150	7.480	1.772	2.559	0°	0°	CC..32.5..	2.425
PSC32-SCLCR/L22040-12	1.260	4.331	4.882	0.866	1.575	0°	0°	CC..43..	0.465
PSC40-SCLCR/L27050-12	1.575	4.331	5.512	1.063	1.969	0°	0°	CC..43..	0.930
PSC50-SCLCR/L35060-12	1.969	4.331	6.496	1.378	2.362	0°	0°	CC..43..	1.765
PSC63-SCLCR/L45065-12	2.480	4.331	7.480	1.772	2.559	0°	0°	CC..43..	2.425

Reference					Nm
PSC32-SCLCR/L22040-09	1240	5515	-	-	3.0
PSC40-SCLCR/L27050-09	1240	5515	-	-	3.0
PSC50-SCLCR/L35060-09	1240	5515	-	-	3.0
PSC63-SCLCR/L45065-09	1240	5515	-	-	3.0
PSC32-SCLCR/L22040-12	1540	5517	3614	1760	3.0
PSC40-SCLCR/L27050-12	1540	5517	3614	1760	3.0
PSC50-SCLCR/L35060-12	1540	5517	3614	1760	3.0
PSC63-SCLCR/L45065-12	1540	5517	3614	1760	3.0

CC.. 80° rhombic positive inserts with 7° clearance. A23

Reference	l	T	d
CC..32.5..	0.380	0.156	0.375
CC..43..	0.508	0.187	0.500

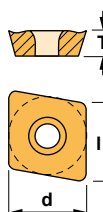

CCGT-AL



CCGT-AP



CCMT



CCMW





Characteristics:
 Multipurpose toolholder equipped with rhombic positive insert (angle 55°).
 PSC with internal coolant.

- 1) γ = Rake angle (valid with a flat insert).
- 2) λs = Angle of inclination.

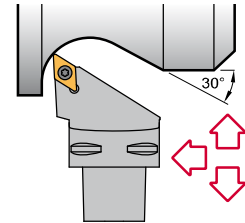
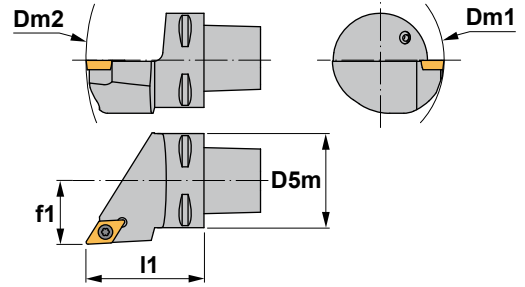

SDJC 93°

Reference	D5m	Dm1 min.	Dm2 min.	f1	l1	γ (1)	λs (2)	Insert size	
PSC32-SDJCR/L22040-07	1.260	3.150	4.882	0.866	1.575	0°	0°	DC..21.5..	0.465
PSC40-SDJCR/L27050-07	1.575	3.150	5.512	1.063	1.969	0°	0°	DC..21.5..	0.930
PSC32-SDJCR/L22040-11	1.260	4.331	4.882	0.866	1.575	0°	0°	DC..32.5..	0.465
PSC40-SDJCR/L27050-11	1.575	4.331	5.512	1.063	1.969	0°	0°	DC..32.5..	0.930
PSC50-SDJCR/L35060-11	1.969	4.331	6.496	1.378	2.362	0°	0°	DC..32.5..	1.765
PSC63-SDJCR/L45065-11	2.480	4.331	7.480	1.772	2.559	0°	0°	DC..32.5..	2.425

Reference					Nm
PSC32-SDJCR/L22040-07	1225	5507	-	-	0.9
PSC40-SDJCR/L27050-07	1225	5507	-	-	0.9
PSC32-SDJCR/L22040-11	1335	5516	3714	1750	3.0
PSC40-SDJCR/L27050-11	1335	5516	3714	1750	3.0
PSC50-SDJCR/L35060-11	1335	5516	3714	1750	3.0
PSC63-SDJCR/L45065-11	1335	5516	3714	1750	3.0

DC..

55° rhombic positive inserts with 7° clearance. A27

Reference	l	T	d
DC..21.5..	0.305	0.093	0.250
DC..32.5..	0.456	0.156	0.375

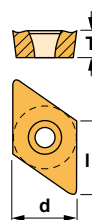

DCGT-AL



DCGT-AP



DCMT



DCMW

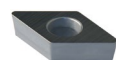



Characteristics:
 Multipurpose profiling toolholder equipped with rhombic positive insert (angle 55°).
 PSC with internal coolant.

- 1) γ = Rake angle (valid with a flat insert).
- 2) λ_s = Angle of inclination.

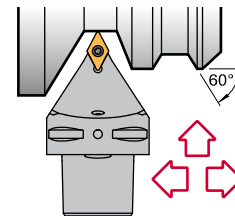
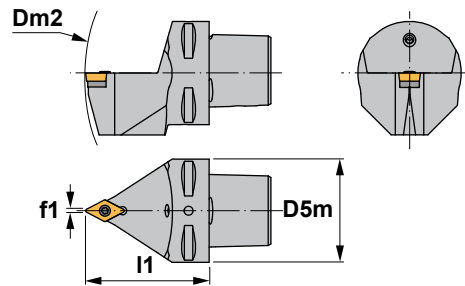

SDNC 62° 30'

Reference	D5m	Dm2 min.	f1	l1	γ^1	λ_s^2	Insert size	
PSC32-SDNCN00040-11	1.260	4.882	0.020	1.575	0°	0°	DC..32.5..	0.350
PSC40-SDNCN00050-11	1.575	5.512	0.020	1.969	0°	0°	DC..32.5..	0.770
PSC50-SDNCN00060-11	1.969	6.496	0.020	2.362	0°	0°	DC..32.5..	1.655

Reference					Nm
PSC32-SDNCN00040-11	1335	5516	3714	1750	3.0
PSC40-SDNCN00050-11	1335	5516	3714	1750	3.0
PSC50-SDNCN00060-11	1335	5516	3714	1750	3.0

DC..

55° rhombic positive inserts with 7° clearance. A27

Reference	l	T	d
DC..32.5..	0.456	0.156	0.375

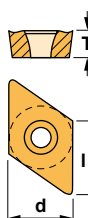

DCGT-AL



DCGT-AP



DCMT



DCMW

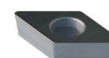



Characteristics:
Profiling toolholder equipped with round positive insert. PSC with internal coolant.

- 1) γ = Rake angle (valid with a flat insert).
- 2) λ_s = Angle of inclination.

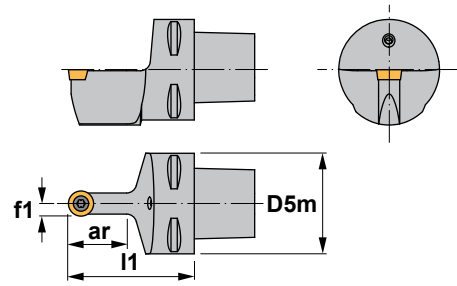
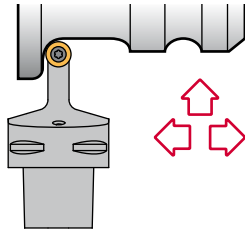

SRDC

Reference	ar	D5m	f1	l1	γ^1	λ_s^2	Insert size	
PSC32-SRDCN00040-06	0.472	1.260	0.118	1.575	0°	0°	RC..0602M0	0.350
PSC40-SRDCN00050-06	0.472	1.575	0.118	1.969	0°	0°	RC..0602M0	0.770
PSC50-SRDCN00060-06	0.472	1.969	0.118	2.362	0°	0°	RC..0602M0	1.655
PSC32-SRDCN00040-08	0.630	1.260	0.157	1.575	0°	0°	RC..0803M0	0.350
PSC40-SRDCN00050-08	0.630	1.575	0.157	1.969	0°	0°	RC..0803M0	0.770
PSC50-SRDCN00060-08	0.630	1.969	0.157	2.362	0°	0°	RC..0803M0	1.655
PSC32-SRDCN00040-10	0.787	1.260	0.197	1.575	0°	0°	RC..10T3M0	0.350
PSC40-SRDCN00050-10	0.984	1.575	0.197	1.969	0°	0°	RC..10T3M0	0.770
PSC50-SRDCN00060-10	0.984	1.969	0.197	2.362	0°	0°	RC..10T3M0	1.655
PSC63-SRDCN00065-10	0.984	2.480	0.197	2.559	0°	0°	RC..10T3M0	2.360
PSC40-SRDCN00050-12	1.102	1.575	0.236	1.969	0°	0°	RC..1204M0	0.770
PSC50-SRDCN00060-12	1.102	1.969	0.236	2.362	0°	0°	RC..1204M0	1.655
PSC63-SRDCN00065-12	1.102	2.480	0.236	2.559	0°	0°	RC..1204M0	2.360
PSC50-SRDCN00060-16	1.378	1.969	0.315	2.362	0°	0°	RC..1606M0	1.655
PSC63-SRDCN00065-16	1.378	2.480	0.315	2.559	0°	0°	RC..1606M0	2.360
PSC50-SRDCN00060-20	1.575	1.969	0.394	2.362	0°	0°	RC..2006M0	1.655
PSC63-SRDCN00065-20	1.575	2.480	0.394	2.559	0°	0°	RC..2006M0	2.360

Reference					Nm
... -06	1225	5507	-	-	0.9
... -08	1230	5508	-	-	1.2
... -10	1335	5516	3811	1750	3.0
... -12	1335	5516	3814	1750	3.0
... -16	1540	5517	3816	1765	3.0
... -20	1260	5520	3919	1059	4.0

RC..

Round positive inserts with 7° clearance. A31

Reference	T	d
RC..0602M0	0.094	0.236
RC..0803M0	0.125	0.315
RC..10T3M0	0.156	0.394
RC..1204M0	0.187	0.472
RC..1606M0	0.250	0.630
RC..2006M0	0.250	0.787

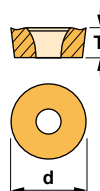

RCGT-AL

RCGT-AP



RCMT







Characteristics:



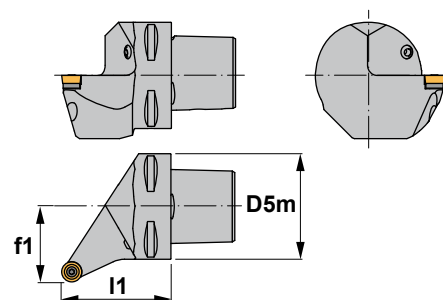
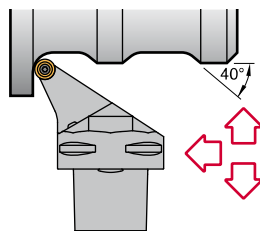

Profiling toolholder equipped with round positive insert. PSC with internal coolant.

- 1) γ = Rake angle (valid with a flat insert).
2) λ_s = Angle of inclination.



SRSC 45°

Reference	D5m	f1	l1	γ^1	λ_s^2	Insert size	
PSC32-SRSCR/L22040-06	1.260	0.866	1.575	0°	0°	RC..0602M0	0.465
PSC40-SRSCR/L27050-06	1.575	1.063	1.969	0°	0°	RC..0602M0	0.930
PSC50-SRSCR/L35060-06	1.969	1.378	2.362	0°	0°	RC..0602M0	1.765
PSC32-SRSCR/L22040-08	1.260	0.866	1.575	0°	0°	RC..0803M0	0.465
PSC40-SRSCR/L27050-08	1.575	1.063	1.969	0°	0°	RC..0803M0	0.930
PSC50-SRSCR/L35060-08	1.969	1.378	2.362	0°	0°	RC..0803M0	1.765
PSC32-SRSCR/L22040-10	1.260	0.866	1.575	0°	0°	RC..10T3M0	0.465
PSC40-SRSCR/L27050-10	1.575	1.063	1.969	0°	0°	RC..10T3M0	0.930
PSC50-SRSCR/L35060-10	1.969	1.378	2.362	0°	0°	RC..10T3M0	1.765
PSC63-SRSCR/L45065-10	2.480	1.772	2.559	0°	0°	RC..10T3M0	2.425
PSC40-SRSCR/L27050-12	1.575	1.063	1.969	0°	0°	RC..1204M0	0.930
PSC50-SRSCR/L35060-12	1.969	1.378	2.362	0°	0°	RC..1204M0	1.765
PSC63-SRSCR/L45065-12	2.480	1.772	2.559	0°	0°	RC..1204M0	2.425
PSC50-SRSCR/L35060-16	1.969	1.378	2.362	0°	0°	RC..1606M0	1.765
PSC63-SRSCR/L45065-16	2.480	1.772	2.559	0°	0°	RC..1606M0	2.425
PSC50-SRSCR/L35060-20	1.969	1.378	2.362	0°	0°	RC..2006M0	1.765
PSC63-SRSCR/L45065-20	2.480	1.772	2.559	0°	0°	RC..2006M0	2.425

Reference					Nm
...-06	1225	5507	-	-	0.9
...-08	1230	5508	-	-	1.2
...-10	1335	5516	3811	1750	3.0
...-12	1335	5516	3814	1750	3.0
...-16	1540	5517	3816	1765	3.0
...-20	1260	5520	3919	1059	4.0

RC..

Round positive inserts with 7° clearance.  A31

Reference	T	d
RC..0602M0	0.094	0.236
RC..0803M0	0.125	0.315
RC..10T3M0	0.156	0.394
RC..1204M0	0.187	0.472
RC..1606M0	0.250	0.630
RC..2006M0	0.250	0.787

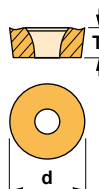

RCGT-AL

RCGT-AP



RCMT





Characteristics:

Toolholder for external turning and chamfering applications equipped with square positive inserts.
PSC with internal coolant.

- 1) γ = Rake angle (valid with a flat insert).
- 2) λ_s = Angle of inclination.

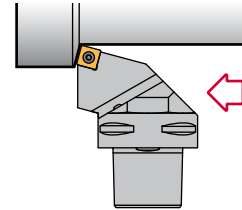
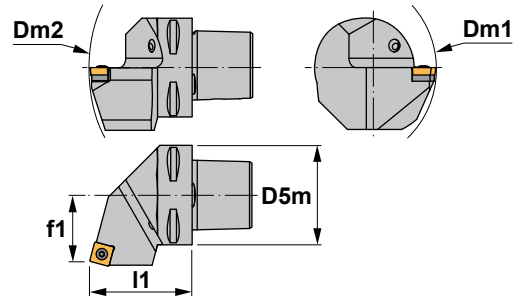

SSRC 75°

Reference	D5m	Dm1 min.	Dm2 min.	f1	l1	γ^1	λ_s^2	Insert size	lbs
PSC40-SSRCR/L22050-12	1.575	4.331	5.512	0.866	1.969	0°	0°	SC..43..	0.930
PSC50-SSRCR/L27060-12	1.969	4.331	6.496	1.063	2.362	0°	0°	SC..43..	1.765

Reference					Nm
PSC40-SSRCR/L22050-12	1540	5517	3514	1760	3.0
PSC50-SSRCR/L27060-12	1540	5517	3514	1760	3.0

SC.. Square positive inserts with 7° clearance. A32					
Reference	l	T	d		
SC..43..	0.500	0.187	0.500		





Characteristics:
 Toolholder for external turning applications equipped with triangular positive inserts. PSC with internal coolant.

- 1) γ = Rake angle (valid with a flat insert).
- 2) λ_s = Angle of inclination.

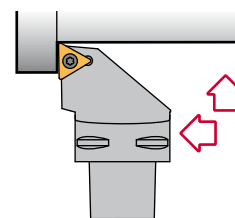
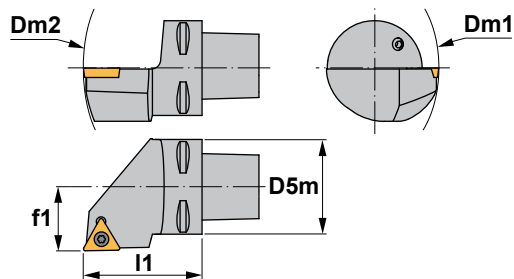

STGC 90°

Reference	D5m	Dm1 min.	Dm2 min.	f1	l1	γ^1	λ_s^2	Insert size	lbs
PSC32-STGCR/L22040-11	1.260	3.150	4.882	0.866	1.575	0°	0°	TC..21.5..	0.465
PSC40-STGCR/L27050-11	1.575	3.150	5.512	1.063	1.969	0°	0°	TC..21.5..	0.930
PSC32-STGCR/L22040-16	1.260	4.331	4.882	0.866	1.575	0°	0°	TC..32.5..	0.465
PSC40-STGCR/L27050-16	1.575	4.331	5.512	1.063	1.969	0°	0°	TC..32.5..	0.930
PSC50-STGCR/L35060-16	1.969	4.331	6.496	1.378	2.362	0°	0°	TC..32.5..	1.765
PSC63-STGCR/L45065-16	2.480	4.331	7.480	1.772	2.559	0°	0°	TC..32.5..	2.425

Reference					Nm
PSC32-STGCR/L22040-11		1225	5507	-	0.9
PSC40-STGCR/L27050-11		1225	5507	-	0.9
PSC32-STGCR/L22040-16		1335	5516	3414	3.0
PSC40-STGCR/L27050-16		1335	5516	3414	3.0
PSC50-STGCR/L35060-16		1335	5516	3414	3.0
PSC63-STGCR/L45065-16		1335	5516	3414	3.0

TC..

Triangular positive inserts with 7° clearance. A36

Reference	l	T	d
TC..21.5..	0.433	0.094	0.250
TC..32.5..	0.650	0.156	0.375

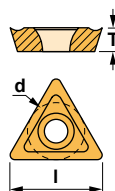

TCGT-AL



TCMT



TCMW





Characteristics:
 Toolholder for external and face turning applications equipped with triangular positive inserts.
 PSC with internal coolant.

- 1) γ = Rake angle (valid with a flat insert).
- 2) λ_s = Angle of inclination.

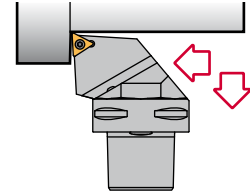
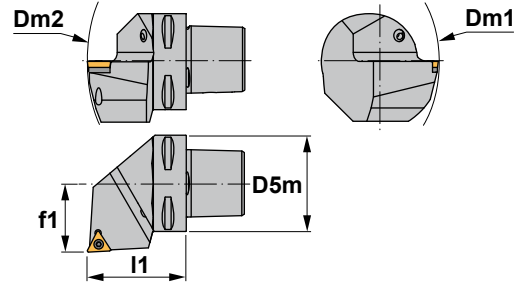

STJC 93°

Reference	D5m	Dm1 min.	Dm2 min.	f1	l1	γ^1	λ_s^2	Insert size	
PSC32-STJCR/L22040-11	1.260	3.150	4.882	0.866	1.575	0°	0°	TC..21.5..	0.465
PSC40-STJCR/L27050-11	1.575	3.150	5.512	1.063	1.969	0°	0°	TC..21.5..	0.930
PSC32-STJCR/L22040-16	1.260	4.331	4.882	0.866	1.575	0°	0°	TC..32.5..	0.465
PSC40-STJCR/L27050-16	1.575	4.331	5.512	1.063	1.969	0°	0°	TC..32.5..	0.930
PSC50-STJCR/L35060-16	1.969	4.331	6.496	1.378	2.362	0°	0°	TC..32.5..	1.765

Reference					Nm
PSC32-STJCR/L22040-11	1225	5507	-	-	0.9
PSC40-STJCR/L27050-11	1225	5507	-	-	0.9
PSC32-STJCR/L22040-16	1335	5516	3414	1750	3.0
PSC40-STJCR/L27050-16	1335	5516	3414	1750	3.0
PSC50-STJCR/L35060-16	1335	5516	3414	1750	3.0

TC..				Triangular positive inserts with 7° clearance. A36		TCGT-AL		TCMT	
Reference	l	T	d						
TC..21.5..	0.433	0.094	0.250						
TC..32.5..	0.650	0.156	0.375						
						TCMW			





Characteristics:
 Multipurpose profiling toolholder equipped with rhombic positive insert (angle 35°).
 PSC with internal coolant.

- 1) γ = Rake angle (valid with a flat insert).
- 2) λ_s = Angle of inclination.

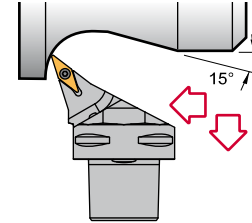
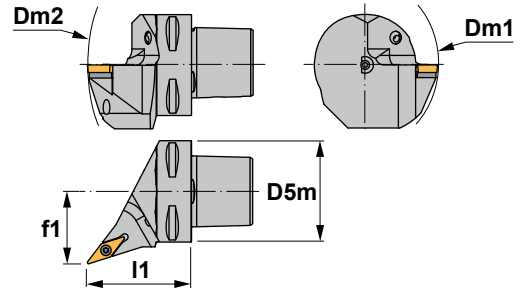

SVHB 107° 30'

Reference	D5m	Dm1 min.	Dm2 min.	f1	l1	γ^1	λ_s^2	Insert size	
PSC40-SVHBR/L27050-16	1.575	4.331	5.512	1.063	1.969	0°	0°	VBMT33..	0.930
PSC50-SVHBR/L35060-16	1.969	4.331	6.496	1.378	2.362	0°	0°	VBMT33..	1.765
PSC63-SVHBR/L45065-16	2.480	4.331	7.480	1.772	2.559	0°	0°	VBMT33..	2.425

Reference					Nm
PSC40-SVHBR/L27050-16	1335	5516	3718	1750	3.0
PSC50-SVHBR/L35060-16	1335	5516	3718	1750	3.0
PSC63-SVHBR/L45065-16	1335	5516	3718	1750	3.0

VBMT

35° rhombic positive insert with 5° clearance. A40

Reference	l	T	d
VBMT33..	0.650	0.187	0.375

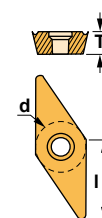



Characteristics:
 Multipurpose profiling toolholder equipped with rhombic positive insert (angle 35°).
 PSC with internal coolant.

- 1) γ = Rake angle (valid with a flat insert).
- 2) λ_s = Angle of inclination.

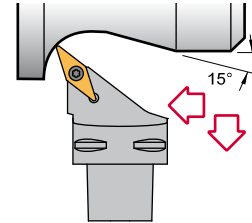
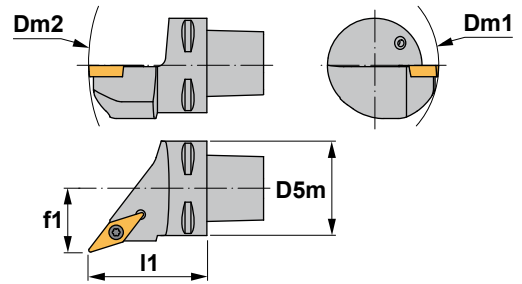

SVHC 107° 30'

Reference	D5m	Dm1 min.	Dm2 min.	f1	l1	γ 1	λ_s 2)	Insert size	lbs
PSC32-SVHCR/L22040-11	1.260	3.150	4.882	0.866	1.575	0°	0°	VC..22..	0.465
PSC40-SVHCR/L27050-11	1.575	3.150	5.512	1.063	1.969	0°	0°	VC..22..	0.930
PSC50-SVHCR/L35060-11	1.969	3.150	6.496	1.378	2.362	0°	0°	VC..22..	1.765
PSC40-SVHCR/L27050-16	1.575	4.331	5.512	1.063	1.969	0°	0°	VC..33..	0.930
PSC50-SVHCR/L35060-16	1.969	4.331	6.496	1.378	2.362	0°	0°	VC..33..	1.765
PSC63-SVHCR/L45065-16	2.480	4.331	7.480	1.772	2.559	0°	0°	VC..33..	2.425

Reference					Nm
PSC32-SVHCR/L22040-11	1225	5507	-	-	0.9
PSC40-SVHCR/L27050-11	1225	5507	-	-	0.9
PSC50-SVHCR/L35060-11	1225	5507	-	-	0.9
PSC40-SVHCR/L27050-16	1335	5516	3718	1750	3.0
PSC50-SVHCR/L35060-16	1335	5516	3718	1750	3.0
PSC63-SVHCR/L45065-16	1335	5516	3718	1750	3.0

VC..

35° rhombic positive inserts with 7° clearance. A40

Reference	l	T	d
VC..22..	0.433	0.125	0.250
VC..33..	0.650	0.187	0.375

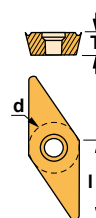

VCGT-AL



VCGT-AP



VCMT





Characteristics:
 Multipurpose profiling toolholder equipped with rhombic 5° positive insert (angle 35°). PSC with internal coolant.

- 1) γ = Rake angle (valid with a flat insert).
- 2) λ_s = Angle of inclination.

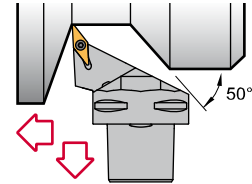
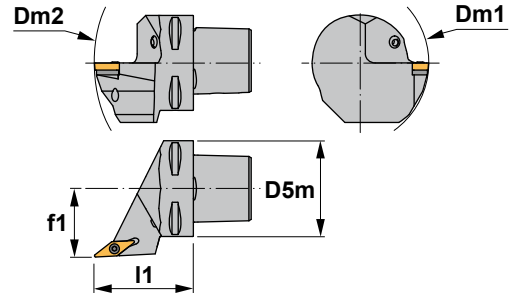

SVJB 93°

Reference	D5m	Dm1 min.	Dm2 min.	f1	l1	γ^1	λ_s^2	Insert size	
PSC40-SVJBR/L27050-16	1.575	4.331	5.709	1.063	1.969	0°	0°	VBMT33..	0.930
PSC50-SVJBR/L35060-16	1.969	4.331	6.496	1.378	2.362	0°	0°	VBMT33..	1.765
PSC63-SVJBR/L45065-16	2.480	4.331	7.480	1.772	2.559	0°	0°	VBMT33..	2.425

Reference					Nm
PSC40-SVJBR/L27050-16	1335	5516	3718	1750	3.0
PSC50-SVJBR/L35060-16	1335	5516	3718	1750	3.0
PSC63-SVJBR/L45065-16	1335	5516	3718	1750	3.0

VBMT

35° rhombic positive insert with 5° clearance. A40

Reference	l	T	d
VBMT33..	0.650	0.187	0.375

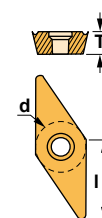



Characteristics:
 Multipurpose profiling toolholder equipped with rhombic positive insert (angle 35°).
 PSC with internal coolant.

- 1) γ = Rake angle (valid with a flat insert).
- 2) λ_s = Angle of inclination.

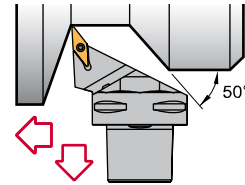
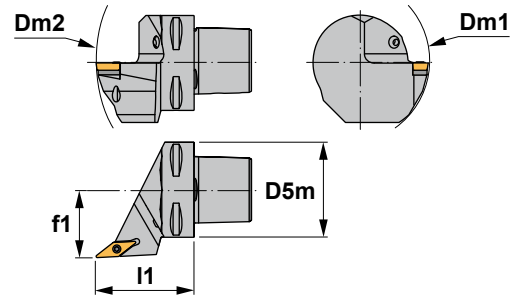

SVJC 93°

Reference	D5m	Dm1 min.	Dm2 min.	f1	l1	γ^1	λ_s^2	Insert size	
PSC32-SVJCR/L22040-11	1.260	3.150	4.764	0.866	1.575	0°	0°	VC..22..	0.465
PSC40-SVJCR/L27050-11	1.575	3.150	5.709	1.063	1.969	0°	0°	VC..22..	0.930
PSC50-SVJCR/L35060-11	1.969	3.150	6.496	1.378	2.362	0°	0°	VC..22..	1.765
PSC40-SVJCR/L27050-16	1.575	4.331	5.709	1.063	1.969	0°	0°	VC..33..	0.930
PSC50-SVJCR/L35060-16	1.969	4.331	6.496	1.378	2.362	0°	0°	VC..33..	1.765
PSC63-SVJCR/L45065-16	2.480	4.331	7.480	1.772	2.559	0°	0°	VC..33..	2.425

Reference					Nm
PSC32-SVJCR/L22040-11	1225	5507	-	-	0.9
PSC40-SVJCR/L27050-11	1225	5507	-	-	0.9
PSC50-SVJCR/L35060-11	1225	5507	-	-	0.9
PSC40-SVJCR/L27050-16	1335	5516	3718	1750	3.0
PSC50-SVJCR/L35060-16	1335	5516	3718	1750	3.0
PSC63-SVJCR/L45065-16	1335	5516	3718	1750	3.0

VC.. 35° rhombic positive inserts with 7° clearance. A40

Reference	l	T	d
VC..22..	0.433	0.125	0.250
VC..33..	0.650	0.187	0.375

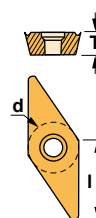

VCGT-AL



VCGT-AP



VCMT





Characteristics:
 Toolholder for multi-task machining equipped with rhombic negative inserts (angle 35°).
 PSC with internal coolant.
 HP= High pressure coolant.

1) γ = Rake angle (valid with a flat insert).
 2) λ_s = Angle of inclination.

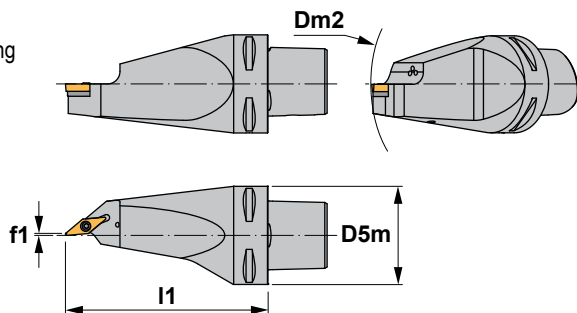

Main application

Alternative use

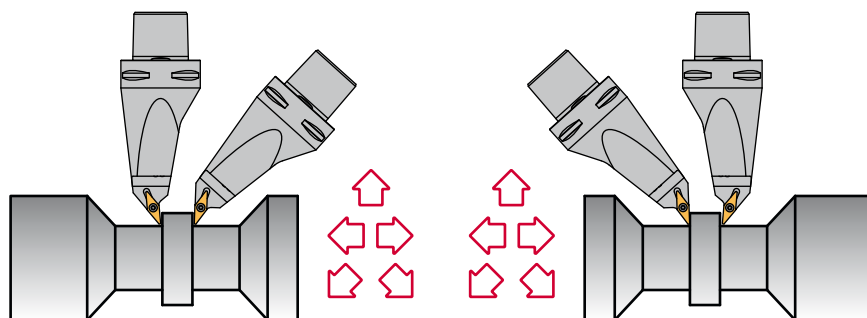

SVMB 50°

Reference	D5m	Dm2 min.	f1	l1	γ^1	λ_s^2	Insert size	lbs
PSC63-SVMBR/L00130-16HP	2.480	4.331	0.047	5.118	0°	0°	VBMT33..	3.725

Reference					Nm
PSC63-SVMBR/L00130-16HP	1335	5516	3718	1750	3.0

VBMT

35° rhombic positive insert with 5° clearance. ⓘ A40

Reference	l	T	d
VBMT33..	0.650	0.187	0.375

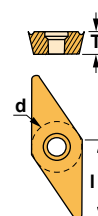

VBMT





Characteristics:

Multipurpose profiling toolholder equipped with rhombic 5° positive insert (angle 35°). PSC with internal coolant.

- 1) γ = Rake angle (valid with a flat insert).
- 2) λ_s = Angle of inclination.

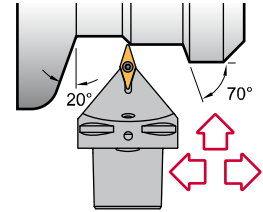
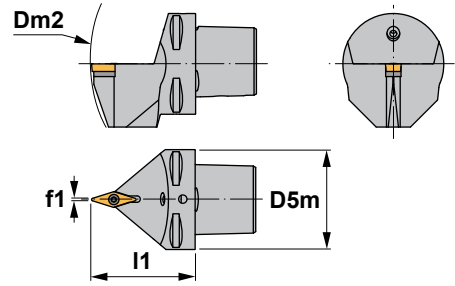

SVVB 72° 30'

Reference	D5m	Dm2 min.	f1	l1	γ^1	λ_s^2	Insert size	lbs
PSC40-SVVBN00050-16	1.575	5.512	0.024	1.969	0°	0°	VBMT33..	0.770
PSC50-SVVBN00060-16	1.969	6.496	0.024	2.362	0°	0°	VBMT33..	1.655
PSC63-SVVBN00065-16	2.480	7.480	0.024	2.559	0°	0°	VBMT33..	2.360

Reference					Nm
PSC40-SVVBN00050-16	1335	5516	3718	1750	3.0
PSC50-SVVBN00060-16	1335	5516	3718	1750	3.0
PSC63-SVVBN00065-16	1335	5516	3718	1750	3.0

VBMT				35° rhombic positive insert with 5° clearance. A40	
Reference	l	T	d		
VBMT33..	0.650	0.187	0.375		





Characteristics:
 Multipurpose profiling toolholder equipped with rhombic positive insert (angle 35°).
 PSC with internal coolant.

- 1) γ = Rake angle (valid with a flat insert).
- 2) λ_s = Angle of inclination.

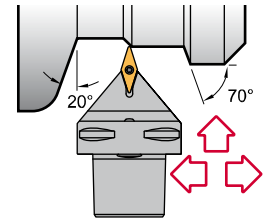
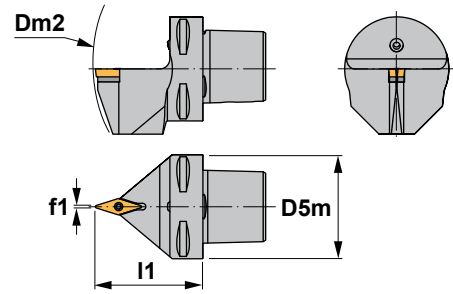

SVVC 72° 30'

Reference	D5m	Dm2 min.	f1	I1	γ^1	λ_s^2	Insert size	lbs
PSC32-SVVCN00040-11	1.260	4.882	0.012	1.575	0°	0°	VC..22..	0.350
PSC40-SVVCN00050-11	1.575	5.512	0.012	1.969	0°	0°	VC..22..	0.770
PSC40-SVVCN00050-16	1.575	5.512	0.024	1.969	0°	0°	VC..33..	0.770
PSC50-SVVCN00060-16	1.969	6.496	0.024	2.362	0°	0°	VC..33..	1.655
PSC63-SVVCN00065-16	2.480	7.480	0.024	2.559	0°	0°	VC..33..	2.360

Reference					Nm
PSC32-SVVCN00040-11	1225	5507	-	-	0.9
PSC40-SVVCN00050-11	1225	5507	-	-	0.9
PSC40-SVVCN00050-16	1335	5516	3718	1750	3.0
PSC50-SVVCN00060-16	1335	5516	3718	1750	3.0
PSC63-SVVCN00065-16	1335	5516	3718	1750	3.0

VC.. 35° rhombic positive inserts with 7° clearance. A40

Reference	l	T	d
VC..22..	0.433	0.125	0.250
VC..33..	0.650	0.187	0.375

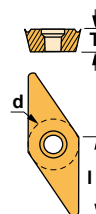

VC GT-AL



VC GT-AP



VC MT





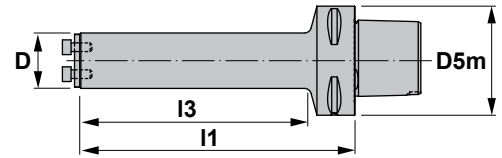

Characteristics:
Antivibratory adaptor.









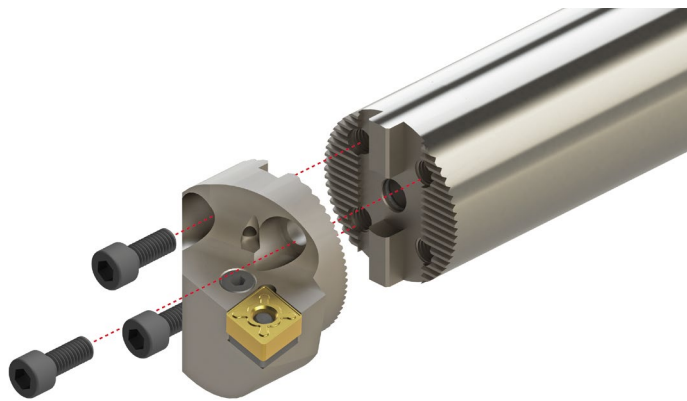

J..  

Reference	D5m	D	I3	I1	
PSC63-J25	2.480	0.984	4.055	5.196	2.865
PSC63-J32	2.480	1.260	5.078	6.300	3.750
PSC63-J40	2.480	1.575	6.653	7.795	5.070
PSC63-J50	2.480	1.969	8.346	9.410	7.275
PSC63-J60	2.480	2.362	10.354	11.300	13.010

Reference			Nm
PSC63-J25	1924	5025	2.0
PSC63-J32	1925	5003	3.0
PSC63-J40	1926	5004	3.5
PSC63-J50	1928	5005	4.0
PSC63-J60	1928	5005	4.0



Boring heads for anti-vibration bars.  A176-183

MTUN 93°-N 	PCLN 95°-N 	PDUN 93°-N 	PWLN 95°-N 
SCLC 95°-N 	SDUC 93°-N 	STFC 90°-N 	STXN 90°-N 



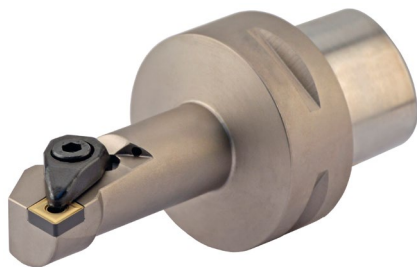

Characteristics:
 Boring bar for internal turning applications equipped with rhombic negative inserts (angle 80°).
 PSC with internal coolant.

- 1) γ = Rake angle (valid with a flat insert).
- 2) λ_s = Angle of inclination.

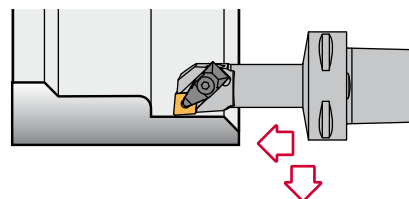
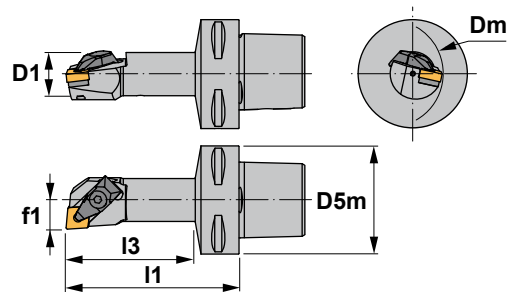

DCLN 95°

Reference	Dm	D1	D5m	f1	I1	I3	γ^1	λ_s^2	Insert size	
PSC40-DCLNR/L13080-09	0.984	0.787	1.575	0.512	3.150	2.244	-6°	-14°	CN..32..	0.880
PSC50-DCLNR/L13080-09	0.984	0.787	1.969	0.512	3.150	2.205	-6°	-14°	CN..32..	1.260
PSC40-DCLNR/L17090-12	1.260	0.984	1.575	0.669	3.543	2.677	-6°	-12°	CN..43..	1.060
PSC50-DCLNR/L17090-12	1.260	0.984	1.969	0.669	3.543	2.598	-6°	-12°	CN..43..	1.545
PSC63-DCLNR/L17100-12	1.260	0.984	2.480	0.669	3.937	2.835	-6°	-12°	CN..43..	2.205
PSC63-DCLNR/L27140-16	1.969	1.575	2.480	1.063	5.512	4.488	-6°	-16°	CN..54..	3.925

Reference							Nm
PSC40-DCLNR/L13080-09	-	-	2708	1695	4294	5004	3.5
PSC50-DCLNR/L13080-09	-	-	2708	1695	4294	5004	3.5
PSC40-DCLNR/L17090-12	1766	ICSN-422	2712	1696	4295	5004	3.5
PSC50-DCLNR/L17090-12	1766	ICSN-422	2712	1696	4295	5004	3.5
PSC63-DCLNR/L17100-12	1766	ICSN-422	2712	1696	4295	5004	3.5
PSC63-DCLNR/L27140-16	1768	ICSN-533	2716	1696	4295	5004	3.5

CN.. 80° rhombic negative inserts. A24-26

Reference	I	T	d
CN..32..	0.380	0.125	0.375
CN..43..	0.508	0.187	0.500
CN..54..	0.633	0.250	0.625

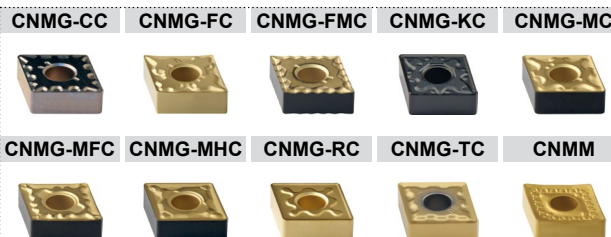
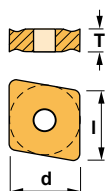



Characteristics:
 Boring bar for internal turning and profiling applications equipped with rhombic negative inserts (angle 55°).
 PSC with internal coolant.

- 1) γ = Rake angle (valid with a flat insert).
- 2) λ_s = Angle of inclination.

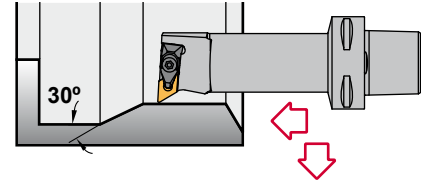
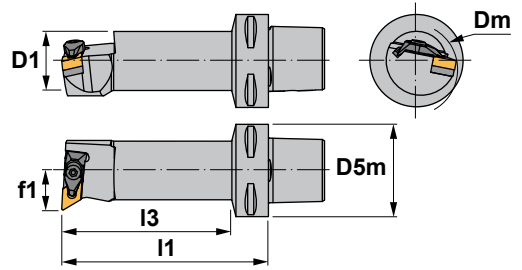

DDUN 93°

Reference	Dm	D1	D5m	f1	I1	I3	$\gamma^1)$	$\lambda_s^2)$	Insert size	
PSC40-DDUNR/L17090-11	1.260	0.984	1.575	0.669	3.543	2.677	-6°	-12°	DN..33..	1.060
PSC50-DDUNR/L17090-11	1.260	0.984	1.969	0.669	3.543	2.598	-6°	-12°	DN..33..	1.545
PSC40-DDUNR/L27080-15	1.969	1.562	1.575	1.063	3.150	2.323	-6°	-11°	DN..44..	1.630
PSC50-DDUNR/L27140-15	1.969	1.575	1.969	1.063	5.512	4.646	-6°	-11°	DN..44..	3.240
PSC63-DDUNR/L27140-15	1.969	1.575	2.480	1.063	5.512	4.488	-6°	-11°	DN..44..	3.925

Reference							Nm
PSC40-DDUNR/L17090-11	1764	IDSN-322	2708	1695	4294	5004	3.5
PSC50-DDUNR/L17090-11	1764	IDSN-322	2708	1695	4294	5004	3.5
PSC40-DDUNR/L27080-15	1766	IDSN-432	2712	1696	4295	5004	3.5
PSC50-DDUNR/L27140-15	1766	IDSN-432	2712	1696	4295	5004	3.5
PSC63-DDUNR/L27140-15	1766	IDSN-432	2712	1696	4295	5004	3.5

DN.. 55° rhombic negative inserts. A28-30

Reference	l	T	d
DN..33..	0.457	0.187	0.375
DN..44..	0.610	0.250	0.500

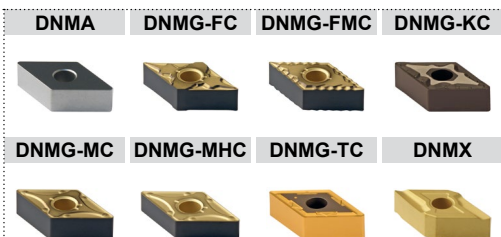

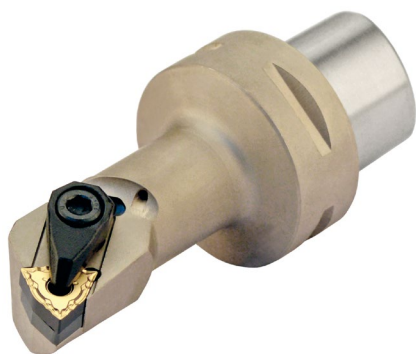

Characteristics:
 Multipurpose boring bar equipped with trigon negative double-sided insert (angle 80°).
 PSC with internal coolant.

1) γ = Rake angle
 (valid with a flat insert).
 2) λ_s = Angle of inclination.

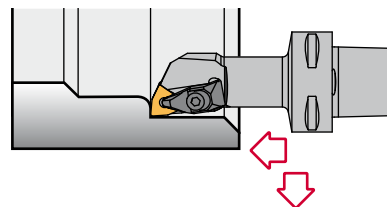
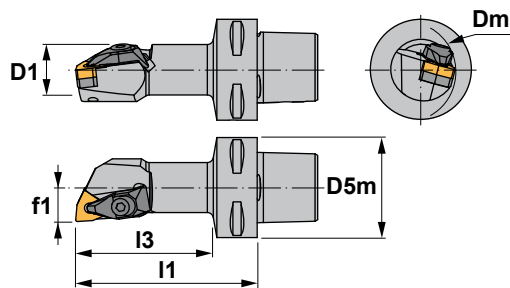

DWLN 95°

Reference	Dm	D1	D5m	f1	I1	I3	γ^1	λ_s^2	Insert size	
PSC40-DWLN/L13075-06	1.299	0.787	1.575	0.512	2.953	2.047	-6°	-17°	WNMG33..	0.925
PSC40-DWLN/L17090-08	1.378	0.984	1.575	0.669	3.543	2.677	-6°	-12°	WNMG43..	1.060
PSC50-DWLN/L17090-08	1.378	0.984	1.969	0.669	3.543	2.598	-6°	-12°	WNMG43..	1.545

Reference							Nm
PSC40-DWLN/L13075-06	1764	IWSN-322	2708	1695	4294	5004	3.5
PSC40-DWLN/L17090-08	1766	IWSN-433	2712	1696	4295	5004	3.5
PSC50-DWLN/L17090-08	1766	IWSN-433	2712	1696	4295	5004	3.5

WNMG

80° trigon negative inserts. A42-43

Reference	l	T	d
WNMG33..	0.254	0.187	0.375
WNMG43..	0.320	0.187	0.500

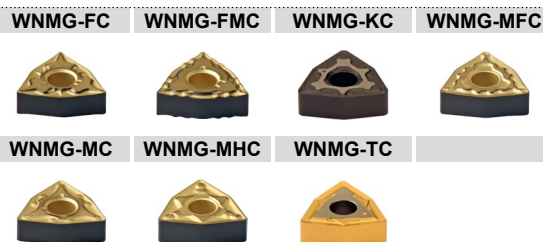
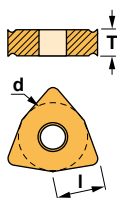



Characteristics:
Internal turning and profiling boring bar equipped with triangular negative double-sided insert.
PSC with internal coolant.

- 1) γ = Rake angle
(valid with a flat insert).
- 2) λ_s = Angle of inclination.

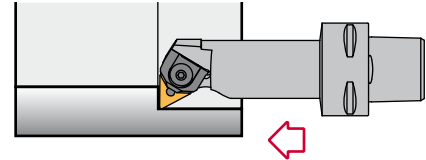
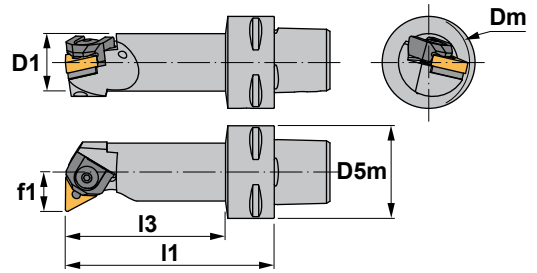

MTFN 90°

Reference	Dm	D1	D5m	f1	I1	I3	γ^1	λ_s^2	Insert size	
PSC40-MTFNR/L17090-16	1.260	0.984	1.575	0.669	3.543	2.717	-6°	-13°	TNM..33..	1.060
PSC40-MTFNR/L22110-16	1.575	1.260	1.575	0.866	4.331	3.504	-6°	-12°	TNM..33..	1.655
PSC40-MTFNR/L27120-16	1.969	1.575	1.575	1.063	4.724	3.937	-6°	-11°	TNM..33..	2.490
PSC50-MTFNR/L17090-16	1.260	0.984	1.969	0.669	3.543	2.638	-6°	-13°	TNM..33..	1.545
PSC50-MTFNR/L22110-16	1.575	1.260	1.969	0.866	4.331	3.465	-6°	-12°	TNM..33..	2.050
PSC50-MTFNR/L27140-16	1.969	1.575	1.969	1.063	5.512	4.685	-6°	-11°	TNM..33..	3.240
PSC63-MTFNR/L22110-16	1.575	1.260	2.480	0.866	4.331	3.307	-6°	-12°	TNM..33..	2.780
PSC63-MTFNR/L27140-16	1.969	1.575	2.480	1.063	5.512	4.528	-6°	-11°	TNM..33..	3.925

Reference						Nm
PSC40-MTFNR/L17090-16	2017	1644	5025	3414	1813	2.0
PSC40-MTFNR/L22110-16	2017	1644	5025	3414	1393	2.0
PSC40-MTFNR/L27120-16	2017	1644	5025	3414	1393	2.0
PSC50-MTFNR/L17090-16	2017	1644	5025	3414	1393	2.0
PSC50-MTFNR/L22110-16	2017	1644	5025	3414	1393	2.0
PSC50-MTFNR/L27140-16	2017	1644	5025	3414	1393	2.0
PSC63-MTFNR/L22110-16	2017	1644	5025	3414	1393	2.0
PSC63-MTFNR/L27140-16	2017	1644	5025	3414	1393	2.0

TNM..			
Triangular negative inserts. A37-38			
Reference	I	T	d
TNM..33..	0.650	0.187	0.375

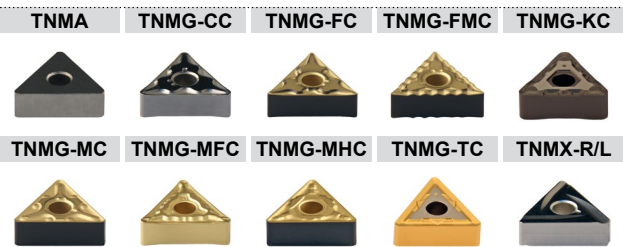
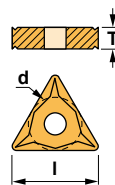



Characteristics:
 Internal turning and profiling boring bar equipped with rhombic negative double-sided insert (angle 35°).
 PSC with internal coolant.

- 1) γ = Rake angle (valid with a flat insert).
- 2) λ_s = Angle of inclination.

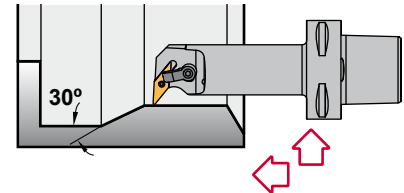
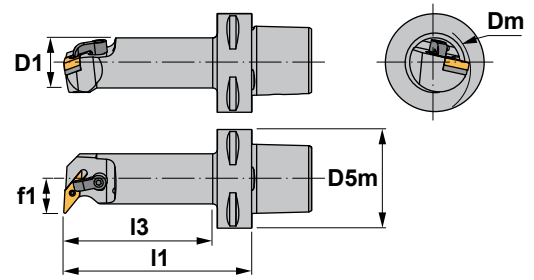

MVUN 93°

Reference	Dm	D1	D5m	f1	I1	I3	γ^1	λ_s^2	Insert size	lbs
PSC40-MVUNR/L27120-16	1.969	1.575	1.575	1.063	4.724	3.937	-6°	-10°	VN..33..	2.490
PSC50-MVUNR/L27140-16	1.969	1.575	1.969	1.063	5.512	4.685	-6°	-10°	VN..33..	3.240
PSC50-MVUNR/L35150-16	2.480	1.969	1.969	1.378	5.906	5.157	-6°	-10°	VN..33..	4.960
PSC63-MVUNR/L22120-16	1.575	1.260	2.480	0.866	4.724	3.701	-6°	-12°	VN..33..	2.820
PSC63-MVUNR/L35175-16	2.480	1.969	2.480	1.378	6.890	5.984	-6°	-10°	VN..33..	6.285

Reference							Nm
PSC40-MVUNR/L27120-16	2614	5003	IVSN-322	1086	1665	5002	3.0
PSC50-MVUNR/L27140-16	2614	5003	IVSN-322	1086	1665	5002	3.0
PSC50-MVUNR/L35150-16	2614	5003	IVSN-322	1086	1665	5002	3.0
PSC63-MVUNR/L22120-16	2614	5003	IVSN-322	1186	1665	5002	3.0
PSC63-MVUNR/L35175-16	2614	5003	IVSN-322	1086	1665	5002	3.0

VN..

35° rhombic negative inserts. A41

Reference	l	T	d
VN..33..	0.650	0.187	0.375

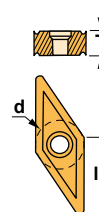

VNGP



VNMG



VNMG-TC





Characteristics:
 Multipurpose boring bar equipped with trigon negative double-sided insert (angle 80°).
 PSC with internal coolant.

- 1) γ = Rake angle (valid with a flat insert).
- 2) λ_s = Angle of inclination.

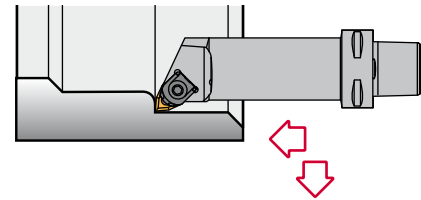
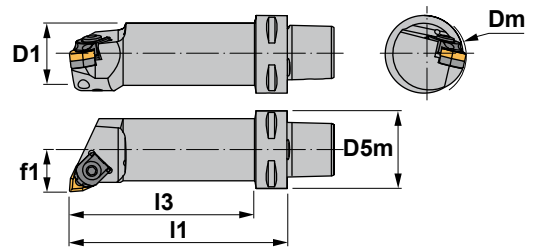

MWLN 95°

Reference	Dm	D1	D5m	f1	I1	I3	γ^1	λ_s^2	Insert size	
PSC32-MWLN/L13075-06	0.984	0.787	1.260	0.512	2.953	2.323	-6°	-14°	WNMG33..	0.530
PSC32-MWLN/L17090-06	1.260	0.984	1.260	0.669	3.543	2.953	-6°	-12°	WNMG33..	0.795
PSC40-MWLN/L13075-06	0.984	0.787	1.575	0.512	2.953	2.087	-6°	-14°	WNMG33..	0.925
PSC40-MWLN/L17090-06	1.260	0.984	1.575	0.669	3.543	2.717	-6°	-12°	WNMG33..	1.060
PSC40-MWLN/L17090-08	1.260	0.984	1.575	0.669	3.543	2.717	-6°	-14°	WNMG43..	1.060
PSC40-MWLN/L22110-08	1.575	1.260	1.575	0.866	4.331	3.504	-6°	-14°	WNMG43..	1.655
PSC40-MWLN/L27120-08	1.969	1.575	1.575	1.063	4.724	3.937	-6°	-12°	WNMG43..	2.490
PSC50-MWLN/L17090-08	1.260	0.984	1.969	0.669	3.543	2.638	-6°	-14°	WNMG43..	1.545
PSC50-MWLN/L22110-08	1.575	1.260	1.969	0.866	4.331	3.465	-6°	-14°	WNMG43..	2.050
PSC50-MWLN/L27140-08	1.969	1.575	1.969	1.063	5.512	4.685	-6°	-12°	WNMG43..	3.240

Reference						Nm
PSC32-MWLN/L13075-06	2006	5025	-	1643	1813	2.0
PSC32-MWLN/L17090-06	2006	5025	3006	1644	1813	2.0
PSC40-MWLN/L13075-06	2006	5025	-	1643	1813	2.0
PSC40-MWLN/L17090-06	2006	5025	3006	1644	1813	2.0
PSC40-MWLN/L17090-08	2011	5005	-	1647	1814	4.0
PSC40-MWLN/L22110-08	2011	5005	IWSN-433	1661	1814	4.0
PSC40-MWLN/L27120-08	2011	5005	IWSN-433	1661	1814	4.0
PSC50-MWLN/L17090-08	2011	5005	-	1647	1814	4.0
PSC50-MWLN/L22110-08	2011	5005	IWSN-433	1661	1814	4.0
PSC50-MWLN/L27140-08	2011	5005	IWSN-433	1661	1814	4.0

WNMG

80° trigon negative inserts. A42-43

Reference	l	T	d
WNMG33..	0.254	0.187	0.375
WNMG43..	0.320	0.187	0.500

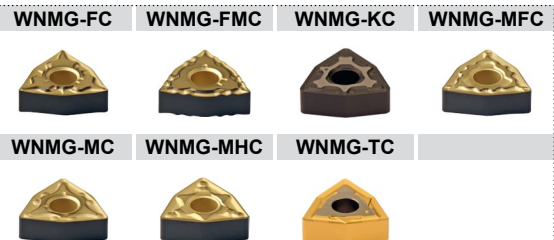
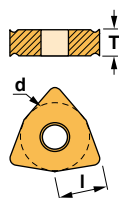



Characteristics: Boring bar for internal turning applications equipped with rhombic negative inserts (angle 80°). PSC with internal coolant.

- 1) γ = Rake angle (valid with a flat insert).
- 2) λ_s = Angle of inclination.

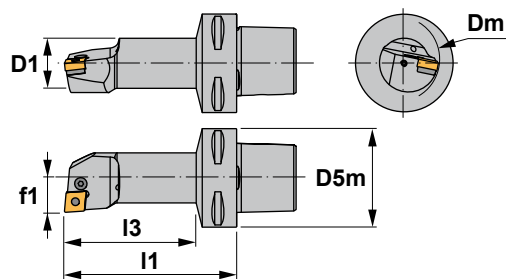
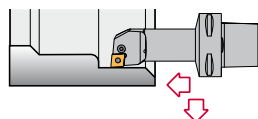

PCLN 95°

Reference	Dm	D1	D5m	f1	I1	I3	$\gamma^{(1)}$	$\lambda_s^{(2)}$	Insert size	
PSC40-PCLNR/L13080-09	0.984	0.787	1.575	0.512	3.150	2.283	-6°	-11°	CN..32..	0.880
PSC50-PCLNR/L13080-09	0.984	0.787	1.969	0.512	3.150	2.205	-6°	-11°	CN..32..	1.260
PSC32-PCLNR/L17090-12	1.260	0.984	1.260	0.669	3.543	2.953	-6°	-11°	CN..43..	0.795
PSC32-PCLNR/L22064-12	1.575	1.260	1.260	0.866	2.520	1.969	-6°	-11°	CN..43..	0.770
PSC32-PCLNR/L22096-12	1.575	1.260	1.260	0.866	3.780	3.228	-6°	-11°	CN..43..	1.215
PSC40-PCLNR/L17090-12	1.260	0.984	1.575	0.669	3.543	2.717	-6°	-11°	CN..43..	1.060
PSC40-PCLNR/L22110-12	1.575	1.260	1.575	0.866	4.331	3.504	-6°	-11°	CN..43..	1.655
PSC40-PCLNR/L27080-12	1.969	1.575	1.575	1.063	3.150	2.362	-6°	-10°	CN..43..	1.630
PSC40-PCLNR/L27120-12	1.969	1.575	1.575	1.063	4.724	3.937	-6°	-11°	CN..43..	2.490
PSC50-PCLNR/L17090-12	1.260	0.984	1.969	0.669	3.543	2.638	-6°	-11°	CN..43..	1.545
PSC50-PCLNR/L22110-12	1.575	1.260	1.969	0.866	4.331	3.465	-6°	-11°	CN..43..	2.050
PSC50-PCLNR/L27140-12	1.969	1.575	1.969	1.063	5.512	4.685	-6°	-10°	CN..43..	3.240
PSC50-PCLNR/L35100-12	2.480	1.969	1.969	1.378	3.937	3.189	-6°	-7°	CN..43..	3.265
PSC63-PCLNR/L17100-12	1.260	0.984	2.480	0.669	3.937	2.913	-6°	-11°	CN..43..	2.205
PSC63-PCLNR/L22110-12	1.575	1.260	2.480	0.866	4.331	3.307	-6°	-11°	CN..43..	2.780
PSC50-PCLNR/L35150-16	2.480	1.969	1.969	1.378	5.906	5.157	-6°	-11°	CN..54..	4.960
PSC63-PCLNR/L27140-16	1.969	1.575	2.480	1.063	5.512	4.528	-6°	-11°	CN..54..	3.925
PSC63-PCLNR/L35175-16	2.480	1.969	2.480	1.378	6.890	5.984	-6°	-11°	CN..54..	6.285

Reference							Nm
PSC40-PCLNR/L13080-09	8005	1605	5002	-	-	-	1.4
PSC50-PCLNR/L13080-09	8005	1605	5002	-	-	-	1.4
PSC32-PCLNR/L17090-12	8212	1626	5025	-	-	-	2.0
PSC32-PCLNR/L22064-12	8312	1648	5003	3612	4112	0012	3.0
PSC32-PCLNR/L22096-12	8312	1648	5003	3612	4112	0012	3.0
PSC40-PCLNR/L17090-12	8212	1626	5025	-	-	-	2.0
PSC40-PCLNR/L22110-12	8312	1648	5003	3612	4112	0012	3.0
PSC40-PCLNR/L27080-12	8012	1608	5003	3612	4112	0012	3.0
PSC40-PCLNR/L27120-12	8012	1608	5003	3612	4112	0012	3.0
PSC50-PCLNR/L17090-12	8212	1626	5025	-	-	-	2.0
PSC50-PCLNR/L22110-12	8312	1648	5003	3612	4112	0012	3.0
PSC50-PCLNR/L27140-12	8012	1608	5003	3612	4112	0012	3.0
PSC50-PCLNR/L35100-12	8012	1608	5003	3612	4112	0012	3.0
PSC63-PCLNR/L17100-12	8212	1626	5025	-	-	-	2.0
PSC63-PCLNR/L22110-12	8312	1648	5003	3612	4112	0012	3.0
PSC50-PCLNR/L35150-16	8016	1618	5003	3616	4115	0015	3.0
PSC63-PCLNR/L27140-16	8016	1618	5003	3616	4115	0015	3.0
PSC63-PCLNR/L35175-16	8016	1618	5003	3616	4115	0015	3.0

CN..

80° rhombic negative inserts. A24-26



Characteristics:

Boring bar for internal turning and profiling applications equipped with rhombic negative inserts (angle 55°). PSC with internal coolant.

- 1) γ = Rake angle (valid with a flat insert).
- 2) λ_s = Angle of inclination.

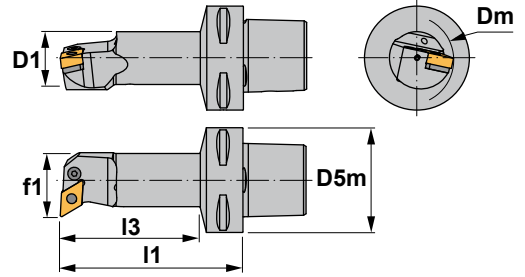
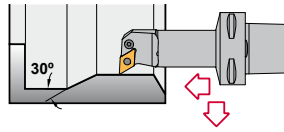

PDUN 93°

Reference	Dm	D1	D5m	f1	I1	I3	γ^1	λ_s^2	Insert size	
PSC32-PDUNR/L17090-11	1.260	0.984	1.260	0.669	3.543	2.953	-6°	-11°	DN..33..	0.795
PSC40-PDUNR/L17090-11	1.260	0.984	1.575	0.669	3.543	2.717	-6°	-11°	DN..33..	1.060
PSC40-PDUNR/L22110-11	1.575	1.260	1.575	0.866	4.331	3.504	-6°	-10°	DN..33..	1.655
PSC50-PDUNR/L17090-11	1.260	0.984	1.969	0.669	3.543	2.638	-6°	-11°	DN..33..	1.545
PSC50-PDUNR/L22110-11	1.575	1.260	1.969	0.866	4.331	3.465	-6°	-10°	DN..33..	2.050
PSC63-PDUNR/L17100-11	1.260	0.984	2.480	0.669	3.937	2.913	-6°	-11°	DN..33..	2.205
PSC40-PDUNR/L27080-15	1.969	1.575	1.575	1.063	3.150	2.362	-6°	-11°	DN..44..	1.630
PSC40-PDUNR/L27120-15	1.969	1.575	1.575	1.063	4.724	3.937	-6°	-11°	DN..44..	2.490
PSC50-PDUNR/L27140-15	1.969	1.575	1.969	1.063	5.512	4.685	-6°	-11°	DN..44..	3.240
PSC50-PDUNR/L35100-15	2.480	1.969	1.969	1.378	3.937	3.189	-6°	-10°	DN..44..	3.265
PSC50-PDUNR/L35150-15	2.480	1.969	1.969	1.378	5.906	5.157	-6°	-10°	DN..44..	4.960
PSC63-PDUNR/L22110-15	1.575	1.260	2.480	0.866	4.331	3.307	-6°	-12°	DN..44..	2.780
PSC63-PDUNR/L27140-15	1.969	1.575	2.480	1.063	5.512	4.528	-6°	-11°	DN..44..	3.925
PSC63-PDUNR/L35175-15	2.480	1.969	2.480	1.378	6.890	5.984	-6°	-10°	DN..44..	6.285

Reference									Nm
PSC32-PDUNR/L17090-11	8009	1606	5025	3711	4109	0009	3725	4135	2.0
PSC40-PDUNR/L17090-11	8009	1606	5025	3711	4109	0009	3725	4135	2.0
PSC40-PDUNR/L22110-11	8009	1606	5025	3711	4109	0009	3725	4135	2.0
PSC50-PDUNR/L17090-11	8009	1606	5025	3711	4109	0009	3725	4135	2.0
PSC50-PDUNR/L22110-11	8009	1606	5025	3711	4109	0009	3725	4135	2.0
PSC63-PDUNR/L17100-11	8009	1606	5025	3711	4109	0009	3725	4135	2.0
PSC40-PDUNR/L27080-15	8415	1638	5003	3715	4112	0012	3725	4135	3.0
PSC40-PDUNR/L27120-15	8415	1638	5003	3715	4112	0012	3725	4135	3.0
PSC50-PDUNR/L27140-15	8415	1638	5003	3715	4112	0012	3725	4135	3.0
PSC50-PDUNR/L35100-15	8415	1638	5003	3715	4112	0012	3725	4135	3.0
PSC50-PDUNR/L35150-15	8415	1638	5003	3715	4112	0012	3725	4135	3.0
PSC63-PDUNR/L22110-15	8415	1638	5003	3715	4112	0012	3725	4135	3.0
PSC63-PDUNR/L27140-15	8415	1638	5003	3715	4112	0012	3725	4135	3.0
PSC63-PDUNR/L35175-15	8415	1638	5003	3715	4112	0012	3725	4135	3.0

For DN..43.. inserts

DN..	55° rhombic negative inserts. A28-30		
Reference	l	T	d
DN..33..	0.457	0.187	0.375
DN..43..	0.610	0.187	0.500
DN..44..	0.610	0.250	0.500

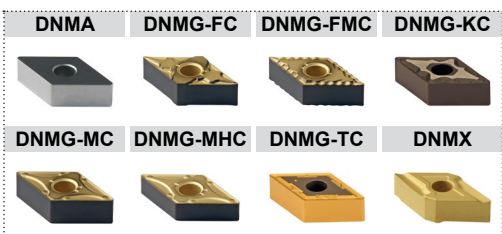



Characteristics:
 Boring bar for internal turning applications equipped with square negative inserts.
 PSC with internal coolant.

- 1) γ = Rake angle (valid with a flat insert).
- 2) λ_s = Angle of inclination.

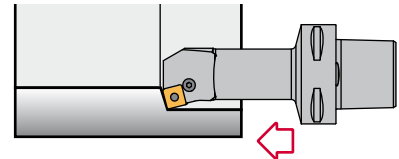
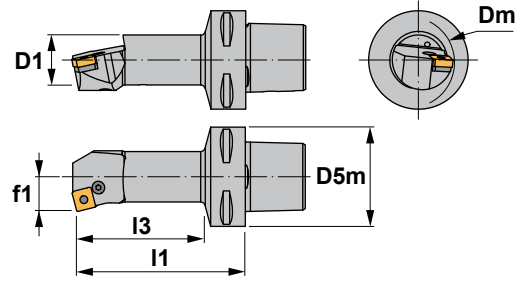

PSKN 75°

Reference	Dm	D1	D5m	f1	I1	I3	γ^1	λ_s^2	Insert size	lbs
PSC40-PSKNR/L17090-12	1.260	0.984	1.575	0.669	3.543	2.717	-6°	-11°	SNM..43..	1.060
PSC50-PSKNR/L17090-12	1.260	0.984	1.969	0.669	3.543	2.638	-6°	-11°	SNM..43..	1.545
PSC50-PSKNR/L22110-12	1.575	1.260	1.969	0.866	4.331	2.677	-6°	-10°	SNM..43..	2.050
PSC50-PSKNR/L27140-12	1.969	1.575	1.969	1.063	5.512	4.685	-6°	-10°	SNM..43..	3.240
PSC63-PSKNR/L22110-12	1.575	1.260	2.480	0.866	4.331	3.307	-6°	-10°	SNM..43..	2.780

Reference							Nm
PSC40-PSKNR/L17090-12	8212	1626	5025	-	-	-	2.0
PSC50-PSKNR/L17090-12	8212	1626	5025	-	-	-	2.0
PSC50-PSKNR/L22110-12	8312	1648	5003	3512	4112	0012	3.0
PSC50-PSKNR/L27140-12	8012	1608	5003	3512	4112	0012	3.0
PSC63-PSKNR/L22110-12	8012	1608	5003	3512	4112	0012	3.0

SNM..

Square negative inserts. A33-34

Reference	I	T	d
SNM..43..	0.500	0.187	0.500

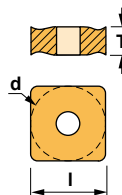

SNMG-FMC



SNMG-KC



SNMG-MHC



SNMG-RC



SNMG-TC



SNMM







SCLC 95°



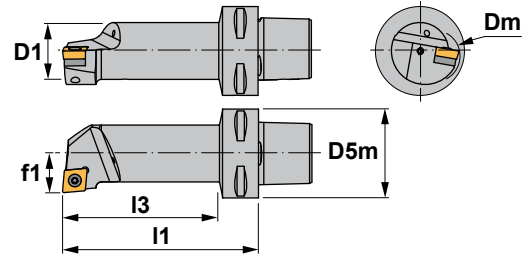
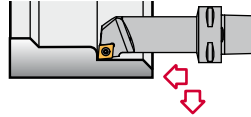

Characteristics:

Multipurpose boring bar equipped with rhombic positive insert (angle 80°). PSC with internal coolant.

- 1) γ = Rake angle (valid with a flat insert).
- 2) λ_s = Angle of inclination.



Reference	Dm	D1	D5m	f1	l1	l3	$\gamma^{1)}$	$\lambda_s^{2)}$	Insert size	
PSC32-SCLCR/L11065-09	0.787	0.630	1.260	0.433	2.559	1.890	0°	-12°	CC..32.5..	0.400
PSC32-SCLCR/L13075-09	0.984	0.787	1.260	0.512	2.953	2.323	0°	-8°	CC..32.5..	0.530
PSC32-SCLCR/L17090-09	1.260	0.984	1.260	0.669	3.543	2.953	0°	-6°	CC..32.5..	0.795
PSC40-SCLCR/L11070-09	0.787	0.630	1.575	0.433	2.756	1.850	0°	-12°	CC..32.5..	0.730
PSC40-SCLCR/L13080-09	0.984	0.787	1.575	0.512	3.150	2.283	0°	-8°	CC..32.5..	0.880
PSC40-SCLCR/L17090-09	1.260	0.984	1.575	0.669	3.543	2.717	0°	-6°	CC..32.5..	1.060
PSC40-SCLCR/L27080-09	1.969	1.562	1.575	1.063	3.150	2.362	0°	-6°	CC..32.5..	1.630
PSC50-SCLCR/L11070-09	0.787	0.630	1.969	0.433	2.756	1.811	0°	-12°	CC..32.5..	1.100
PSC50-SCLCR/L13080-09	0.984	0.787	1.969	0.512	3.150	2.205	0°	-8°	CC..32.5..	1.260
PSC50-SCLCR/L17090-09	1.260	0.984	1.969	0.669	3.543	2.638	0°	-6°	CC..32.5..	1.545
PSC50-SCLCR/L35100-09	2.480	1.956	1.969	1.378	3.937	3.189	0°	-4°	CC..32.5..	3.265
PSC32-SCLCR/L17090-12	1.260	0.984	1.260	0.669	3.543	2.953	0°	-6°	CC..43..	0.795
PSC32-SCLCR/L22064-12	1.575	1.248	1.260	0.866	2.520	1.969	0°	-10°	CC..43..	0.770
PSC32-SCLCR/L22096-12	1.575	1.366	1.260	0.866	3.780	3.228	0°	-10°	CC..43..	1.215
PSC40-SCLCR/L17090-12	1.260	0.984	1.575	0.669	3.543	2.717	0°	-6°	CC..43..	1.060
PSC40-SCLCR/L22110-12	1.575	1.260	1.575	0.866	4.331	3.504	0°	-10°	CC..43..	1.655
PSC40-SCLCR/L27080-12	1.969	1.562	1.575	1.063	3.150	2.362	0°	-8°	CC..43..	1.630
PSC50-SCLCR/L17090-12	1.260	0.984	1.969	0.669	3.543	2.638	0°	-6°	CC..43..	1.545
PSC50-SCLCR/L22110-12	1.575	1.260	1.969	0.866	4.331	3.465	0°	-10°	CC..43..	2.050
PSC50-SCLCR/L27140-12	1.969	1.575	1.969	1.063	5.512	4.685	0°	-8°	CC..43..	3.240
PSC50-SCLCR/L35100-12	2.480	1.956	1.969	1.378	3.937	3.150	0°	-5°	CC..43..	3.265

Reference					Nm
PSC32-SCLCR/L.....-09	1440	5515	-	-	3.0
PSC40-SCLCR/L.....-09	1440	5515	-	-	3.0
PSC40-SCLCR/L17090-09	1240	5515	-	-	3.0
PSC40-SCLCR/L27080-09	1240	5515	-	-	3.0
PSC50-SCLCR/L.....-09	1440	5515	-	-	3.0
PSC50-SCLCR/L17090-09	1240	5515	-	-	3.0
PSC50-SCLCR/L35100-09	1240	5515	-	-	3.0
PSC32-SCLCR/L17090-12	1250	5515	-	-	3.0
PSC32-SCLCR/L22064-12	1540	5517	3614	1760	3.0
PSC32-SCLCR/L22096-12	1540	5517	3614	1760	3.0
PSC40-SCLCR/L17090-12	1250	5520	-	-	4.0
PSC40-SCLCR/L22110-12	1540	5517	3614	1760	3.0
PSC40-SCLCR/L27080-12	1540	5517	3614	1760	3.0
PSC50-SCLCR/L17090-12	1250	5520	-	-	4.0
PSC50-SCLCR/L22110-12	1540	5517	3614	1760	3.0
PSC50-SCLCR/L27140-12	1540	5517	3614	1760	3.0
PSC50-SCLCR/L35100-12	1540	5517	3614	1760	3.0





Characteristics:
 Multipurpose profiling boring bar equipped with rhombic positive insert (angle 55°).
 PSC with internal coolant.

- 1) γ = Rake angle (valid with a flat insert).
- 2) λ_s = Angle of inclination.

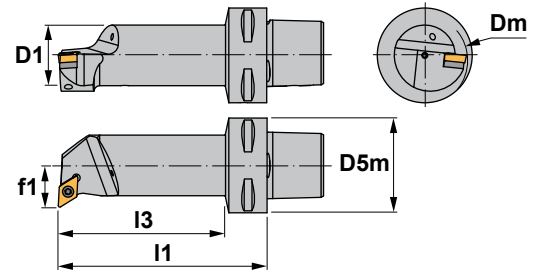
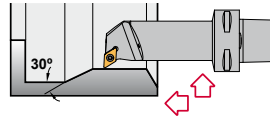

SDUC 93°

Reference	Dm	D1	D5m	f1	I1	I3	γ^1	λ_s^2	Insert size	
PSC32-SDUCR/L11065-07	0.787	0.630	1.260	0.433	2.559	1.890	0°	-6°	DC..21.5..	0.400
PSC40-SDUCR/L11070-07	0.787	0.630	1.575	0.433	2.756	1.850	0°	-8°	DC..21.5..	0.730
PSC50-SDUCR/L11070-07	0.787	0.630	1.969	0.433	2.756	1.811	0°	-8°	DC..21.5..	1.100
PSC32-SDUCR/L13075-11	0.984	0.787	1.260	0.512	2.953	2.323	0°	-6°	DC..32.5..	0.530
PSC32-SDUCR/L17090-11	1.260	0.984	1.260	0.669	3.543	2.953	0°	-6°	DC..32.5..	0.795
PSC32-SDUCR/L22064-11	1.575	1.248	1.260	0.866	2.520	1.969	0°	-6°	DC..32.5..	0.770
PSC32-SDUCR/L22096-11	1.575	1.248	1.260	0.866	3.780	3.228	0°	-6°	DC..32.5..	1.215
PSC40-SDUCR/L13080-11	0.984	0.787	1.575	0.512	3.150	2.283	0°	-6°	DC..32.5..	0.880
PSC40-SDUCR/L17090-11	1.260	0.984	1.575	0.669	3.543	2.717	0°	-6°	DC..32.5..	1.060
PSC40-SDUCR/L22110-11	1.575	1.260	1.575	0.866	4.331	3.504	0°	-6°	DC..32.5..	1.655
PSC40-SDUCR/L27080-11	1.969	1.575	1.575	1.063	3.150	2.362	0°	-6°	DC..32.5..	1.630
PSC50-SDUCR/L13080-11	0.984	0.787	1.969	0.512	3.150	2.205	0°	-6°	DC..32.5..	1.260
PSC50-SDUCR/L17090-11	1.260	0.984	1.969	0.669	3.543	2.638	0°	-6°	DC..32.5..	1.545
PSC50-SDUCR/L22110-11	1.575	1.260	1.969	0.866	4.331	3.465	0°	-6°	DC..32.5..	2.050
PSC50-SDUCR/L35100-11	2.480	1.956	1.969	1.378	3.937	3.189	0°	-4°	DC..32.5..	3.265

Reference					Nm
PSC32-SDUCR/L11065-07	1225	5507	-	-	0.9
PSC40-SDUCR/L11070-07	1225	5507	-	-	0.9
PSC50-SDUCR/L11070-07	1225	5507	-	-	0.9
PSC32-SDUCR/L13075-11	1240	5515	-	-	3.0
PSC32-SDUCR/L17090-11	1240	5515	-	-	3.0
PSC32-SDUCR/L22064-11	1335	5516	3714	1750	3.0
PSC32-SDUCR/L22096-11	1335	5516	3714	1750	3.0
PSC40-SDUCR/L13080-11	1240	5515	-	-	3.0
PSC40-SDUCR/L17090-11	1240	5515	-	-	3.0
PSC40-SDUCR/L22110-11	1335	5516	3714	1750	3.0
PSC40-SDUCR/L27080-11	1335	5516	3714	1750	3.0
PSC50-SDUCR/L13080-11	1240	5515	-	-	3.0
PSC50-SDUCR/L17090-11	1240	5515	-	-	3.0
PSC50-SDUCR/L22110-11	1335	5516	3714	1750	3.0
PSC50-SDUCR/L35100-11	1335	5516	3714	1750	3.0

DC..

55° rhombic positive inserts with 7° clearance. A27

Reference	l	T	d
DC..21.5..	0.305	0.093	0.250
DC..32.5..	0.456	0.156	0.375

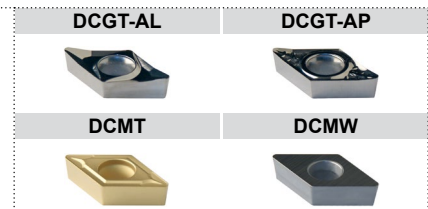
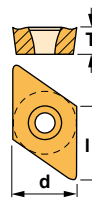



Characteristics:
 Backwards multipurpose profiling boring bar equipped with rhombic positive insert (angle 55°).
 PSC with internal coolant.

- 1) γ = Rake angle (valid with a flat insert).
- 2) λ_s = Angle of inclination.

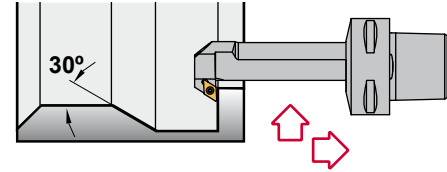
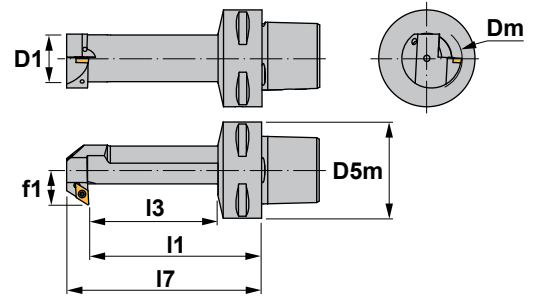

SDUC-X 93°

Reference	Dm	D1	D5m	f1	I1	I3	I7	γ^1 $\lambda_s^{(2)}$	Insert size	
PSC32-SDUCR/L13070-07X	0.866	0.630	1.260	0.512	2.756	2.126	3.177	0° -6°	DC..21.5..	0.460
PSC32-SDUCR/L15080-07X	1.063	0.787	1.260	0.591	3.150	2.520	3.177	0° -3°	DC..21.5..	0.615
PSC40-SDUCR/L13070-07X	0.866	0.630	1.575	0.512	2.756	1.890	3.177	0° -6°	DC..21.5..	0.730
PSC40-SDUCR/L15080-07X	1.063	0.787	1.575	0.591	3.150	2.283	3.602	0° -3°	DC..21.5..	0.880
PSC40-SDUCR/L18090-07X	1.260	0.984	1.575	0.709	3.543	2.717	3.996	0° -3°	DC..21.5..	1.060
PSC50-SDUCR/L15080-07X	1.063	0.787	1.969	0.591	3.150	2.244	3.602	0° -3°	DC..21.5..	1.280
PSC50-SDUCR/L18090-07X	1.260	0.984	1.969	0.709	3.543	2.638	3.996	0° -3°	DC..21.5..	1.480

Reference			Nm
PSC32-SDUCR/L13070-07X	1225	5507	0.9
PSC32-SDUCR/L15080-07X	1225	5507	0.9
PSC40-SDUCR/L13070-07X	1225	5507	0.9
PSC40-SDUCR/L15080-07X	1225	5507	0.9
PSC40-SDUCR/L18090-07X	1225	5507	0.9
PSC50-SDUCR/L15080-07X	1225	5507	0.9
PSC50-SDUCR/L18090-07X	1225	5507	0.9

DC.. 55° rhombic positive inserts with 7° clearance. A27

Reference	l	T	d
DC..21.5..	0.305	0.093	0.250

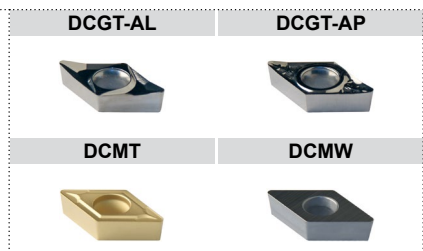
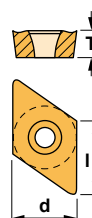



Characteristics:
 Multipurpose boring bar equipped
 with square positive insert.
 PSC with internal coolant.

- 1) γ = Rake angle
 (valid with a flat insert).
- 2) λ_s = Angle of inclination.

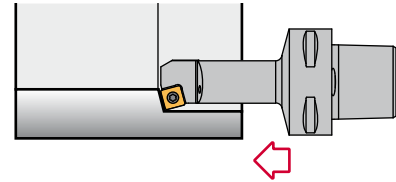
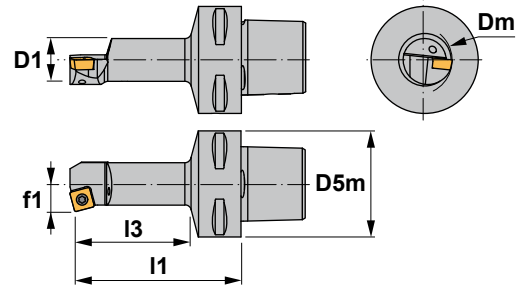

SSKC 75°

Reference	Dm	D1	D5m	f1	I1	I3	γ^1	λ_{s2}	Insert size	
PSC40-SSKCR/L13080-09	0.984	0.787	1.575	0.512	3.150	2.283	0°	-6°	SC..32.5..	0.880
PSC50-SSKCR/L13080-09	0.984	0.787	1.969	0.512	3.150	2.205	0°	-6°	SC..32.5..	1.260

Reference			Nm
PSC40-SSKCR/L13080-09	1540	5517	3.0
PSC50-SSKCR/L13080-09	1540	5517	3.0

SC..

Square positive inserts with 7° clearance. A32

Reference	l	T	d
SC..32.5..	0.375	0.156	0.375

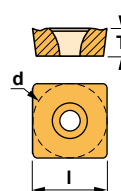

SCGT-AL



SCMT



SCMT-39





Characteristics:
 Multipurpose boring bar equipped with triangular positive insert.
 PSC with internal coolant.

- 1) γ = Rake angle (valid with a flat insert).
- 2) λ_s = Angle of inclination.

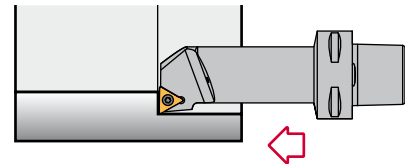
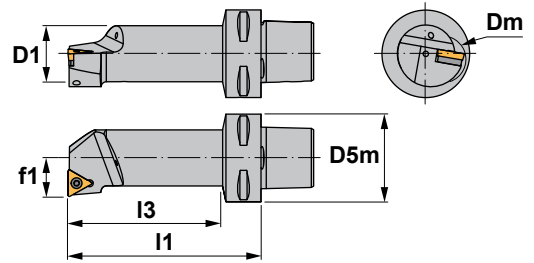

STFC 90°

Reference	Dm	D1	D5m	f1	I1	I3	γ^1	λ_s^2	Insert size	
PSC32-STFCR/L11065-11	0.787	0.630	1.260	0.433	2.559	1.890	0°	-4°	TC..21.5..	0.400
PSC32-STFCR/L13075-11	0.984	0.787	1.260	0.512	2.953	2.323	0°	-3°	TC..21.5..	0.530
PSC40-STFCR/L11070-11	0.787	0.630	1.575	0.433	2.756	1.850	0°	-4°	TC..21.5..	0.730
PSC40-STFCR/L13080-11	0.984	0.787	1.575	0.512	3.150	2.244	0°	-3°	TC..21.5..	0.880
PSC50-STFCR/L11070-11	0.787	0.630	1.969	0.433	2.756	1.811	0°	-4°	TC..21.5..	1.100
PSC50-STFCR/L13080-11	0.984	0.787	1.969	0.512	3.150	2.205	0°	-3°	TC..21.5..	1.260
PSC32-STFCR/L17090-16	1.260	0.984	1.260	0.669	3.543	2.913	0°	-3.5°	TC..32.5..	0.795
PSC40-STFCR/L17090-16	1.260	0.984	1.575	0.669	3.543	2.717	0°	-6°	TC..32.5..	1.060
PSC40-STFCR/L22110-16	1.575	1.260	1.575	0.866	4.331	3.504	0°	-10°	TC..32.5..	1.655
PSC50-STFCR/L17090-16	1.260	0.984	1.969	0.669	3.543	2.638	0°	-6°	TC..32.5..	1.545
PSC50-STFCR/L22110-16	1.575	1.260	1.969	0.866	4.331	3.465	0°	-10°	TC..32.5..	2.050

Reference					Nm
PSC32-STFCR/L11065-11	1225	5507	-	-	0.9
PSC32-STFCR/L13075-11	1225	5507	-	-	0.9
PSC40-STFCR/L11070-11	1225	5507	-	-	0.9
PSC40-STFCR/L13080-11	1225	5507	-	-	0.9
PSC50-STFCR/L11070-11	1225	5507	-	-	0.9
PSC50-STFCR/L13080-11	1225	5507	-	-	0.9
PSC32-STFCR/L17090-16	1240	5515	-	-	3.0
PSC40-STFCR/L17090-16	1240	5515	-	-	3.0
PSC40-STFCR/L22110-16	1335	5516	3414	1750	3.0
PSC50-STFCR/L17090-16	1240	5515	-	-	3.0
PSC50-STFCR/L22110-16	1335	5516	3414	1750	3.0

TC..

Triangular positive inserts with 7° clearance. A36

Reference	l	T	d
TC..21.5..	0.433	0.094	0.250
TC..32.5..	0.650	0.156	0.375

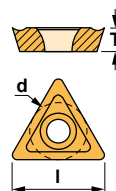

TCGT-AL

TCMT



TCMW





Characteristics:

Multipurpose profiling boring bar equipped with rhombic positive insert (angle 35°).

PSC with internal coolant.

1) γ = Rake angle (valid with a flat insert).

2) λ_s = Angle of inclination.

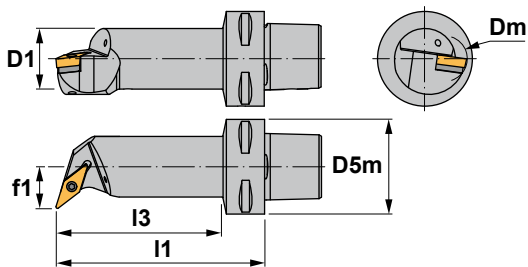
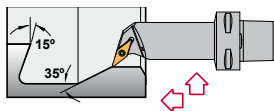

SVQB 107° 30'

Reference	Dm	D1	D5m	f1	I1	I3	γ^1	λ_s^2	Insert size	
PSC32-SVQBR/L18090-16	1.299	0.984	1.260	0.709	3.543	2.953	0°	-6°	VBMT33..	0.795
PSC32-SVQBR/L22064-16	1.575	1.248	1.260	0.866	2.520	1.930	0°	-7.5°	VBMT33..	0.770
PSC32-SVQBR/L22096-16	1.575	1.248	1.260	0.866	3.780	3.228	0°	-8°	VBMT33..	1.215
PSC40-SVQBR/L18090-16	1.299	0.984	1.575	0.709	3.543	2.717	0°	-6°	VBMT33..	1.060
PSC40-SVQBR/L22110-16	1.575	1.260	1.575	0.866	4.331	3.504	0°	-8°	VBMT33..	1.655
PSC40-SVQBR/L27080-16	1.969	1.575	1.575	1.063	3.150	2.362	0°	-8°	VBMT33..	1.630
PSC40-SVQBR/L27120-16	1.969	1.575	1.575	1.063	4.724	3.937	0°	-8°	VBMT33..	2.490
PSC50-SVQBR/L18090-16	1.299	0.984	1.969	0.709	3.543	2.638	0°	-6°	VBMT33..	1.480
PSC50-SVQBR/L22110-16	1.575	1.260	1.969	0.866	4.331	3.465	0°	-8°	VBMT33..	2.050
PSC50-SVQBR/L27140-16	1.969	1.575	1.969	1.063	5.512	4.685	0°	-8°	VBMT33..	3.240
PSC50-SVQBR/L35100-16	2.480	1.969	1.969	1.378	3.937	3.189	0°	-7°	VBMT33..	3.265
PSC50-SVQBR/L35150-16	2.480	1.969	1.969	1.378	5.906	5.157	0°	-7°	VBMT33..	4.960
PSC63-SVQBR/L22120-16	1.575	1.260	2.480	0.866	4.724	3.701	0°	-8°	VBMT33..	2.820
PSC63-SVQBR/L27145-16	1.969	1.575	2.480	1.063	5.709	4.724	0°	-8°	VBMT33..	3.925
PSC63-SVQBR/L35175-16	2.480	1.969	2.480	1.378	6.890	5.984	0°	-8°	VBMT33..	6.285

Reference					Nm
PSC32-SVQBR/L18090-16	1335	5516	3718	1750	3.0
PSC32-SVQBR/L22064-16	1335	5516	3718	1750	3.0
PSC32-SVQBR/L22096-16	1335	5516	3718	1750	3.0
PSC40-SVQBR/L18090-16	1335	5516	3718	1750	3.0
PSC40-SVQBR/L22110-16	1335	5516	3718	1750	3.0
PSC40-SVQBR/L27080-16	1335	5516	3718	1750	3.0
PSC40-SVQBR/L27120-16	1335	5516	3718	1750	3.0
PSC50-SVQBR/L18090-16	1335	5516	3718	1750	3.0
PSC50-SVQBR/L22110-16	1335	5516	3718	1750	3.0
PSC50-SVQBR/L27140-16	1335	5516	3718	1750	3.0
PSC50-SVQBR/L35100-16	1335	5516	3718	1750	3.0
PSC50-SVQBR/L35150-16	1335	5516	3718	1750	3.0
PSC63-SVQBR/L22120-16	1335	5516	3718	1750	3.0
PSC63-SVQBR/L27145-16	1335	5516	3718	1750	3.0
PSC63-SVQBR/L35175-16	1335	5516	3718	1750	3.0

VBMT

35° rhombic positive insert with 5° clearance. A40

Reference

VBMT33..

l	T	d
0.650	0.187	0.375

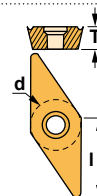

VBMT





Characteristics:
 Multipurpose profiling boring bar equipped with rhombic positive insert (angle 35°).
 PSC with internal coolant.

- 1) γ = Rake angle
(valid with a flat insert).
- 2) λ_s = Angle of inclination.

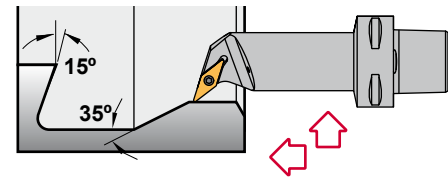
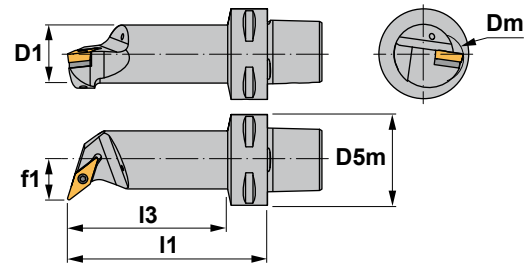

SVQC 107° 30'

Reference	Dm	D1	D5m	f1	l1	l3	$\gamma^{1)}$	$\lambda_s^{2)}$	Insert size	
PSC32-SVQCR/L13070-11	0.866	0.630	1.260	0.512	2.756	2.100	0°	-7°	VC..1103..	0.460
PSC32-SVQCR/L15080-11	1.063	0.787	1.260	0.591	3.150	2.516	0°	-5°	VC..1103..	0.615
PSC40-SVQCR/L13070-11	0.984	0.787	1.575	0.512	2.756	1.886	0°	-5.5°	VC..1103..	0.730
PSC40-SVQCR/L15080-11	1.063	0.787	1.575	0.591	3.150	2.280	0°	-5°	VC..1103..	0.880
PSC40-SVQCR/L18090-16	1.299	0.984	1.575	0.709	3.543	2.717	0°	-12°	VC..1604..	1.060
PSC40-SVQCR/L22110-16	1.575	1.260	1.575	0.866	4.331	3.504	0°	-8°	VC..1604..	1.655
PSC40-SVQCR/L27080-16	1.969	1.575	1.575	1.063	3.150	2.362	0°	-8°	VC..1604..	1.630
PSC40-SVQCR/L27120-16	1.969	1.575	1.575	1.063	4.724	3.937	0°	-8°	VC..1604..	2.490
PSC50-SVQCR/L18090-16	1.299	0.984	1.969	0.709	3.543	2.638	0°	-12°	VC..1604..	1.480
PSC50-SVQCR/L22110-16	1.575	1.260	1.969	0.866	4.331	3.465	0°	-8°	VC..1604..	2.050
PSC50-SVQCR/L27140-16	1.969	1.575	1.969	1.063	5.512	4.685	0°	-8°	VC..1604..	3.240
PSC50-SVQCR/L35100-16	2.480	1.969	1.969	1.378	3.937	3.189	0°	-7°	VC..1604..	3.265
PSC50-SVQCR/L35150-16	2.480	1.969	1.969	1.378	5.906	5.157	0°	-7°	VC..1604..	4.960
PSC63-SVQCR/L22120-16	1.575	1.260	2.480	0.866	4.724	3.701	0°	-8°	VC..1604..	2.820
PSC63-SVQCR/L27145-16	1.969	1.575	2.480	1.063	5.709	4.724	0°	-8°	VC..1604..	3.925
PSC63-SVQCR/L35175-16	2.480	1.969	2.480	1.378	6.890	5.984	0°	-8°	VC..1604..	6.285

Reference					Nm
.....-11	1225	5507	-	-	0.9
.....-16	1335	5516	3718	1750	3.0

VC.. 35° rhombic positive inserts with 7° clearance. A40

Reference	l	T	d
VC..22..	0.433	0.125	0.250
VC..33..	0.650	0.187	0.375

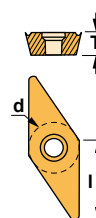

VCGT-AL	VCGT-AP
VCMT	





Characteristics:
 Multipurpose threading toolholder
 for negative lay down inserts.
 PSC with internal coolant.

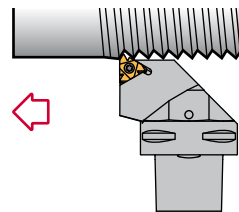
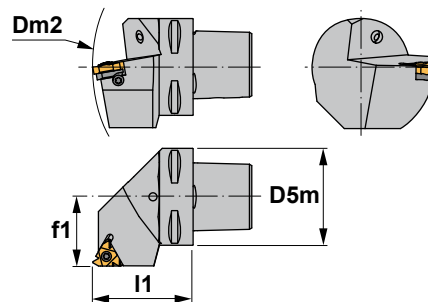

SE 90°

Reference	D5m	Dm2 min.	f1	l1	Insert size	lbs
PSC32-SER/L22040-16	1.260	4.882	0.866	1.575	16ER/L..	0.460
PSC40-SER/L27050-16	1.575	5.512	1.063	1.969	16ER/L..	0.925
PSC50-SER/L35060-16	1.969	6.496	1.378	2.362	16ER/L..	1.765
PSC63-SER/L45065-16	2.480	7.480	1.772	2.559	16ER/L..	2.425
PSC32-SER/L22040-22	1.260	4.882	0.866	1.575	22ER/L..	0.460
PSC40-SER/L27050-22	1.575	5.512	1.063	1.969	22ER/L..	0.925
PSC50-SER/L35060-22	1.969	6.496	1.378	2.362	22ER/L..	1.765
PSC63-SER/L45065-22	2.480	7.480	1.772	2.559	22ER/L..	2.425
PSC80-SER/L55080-22	3.150	9.843	2.165	3.150	22ER/L..	6.040

WARNING!! Because of large thread profile, modification may have to be made to the toolholder to achieve full depth of thread.

Reference						Nm
PSC32-SER/L22040-16	SA3	5510	YE3	YI3	SY3	2.0
PSC40-SER/L27050-16	SA3	5510	YE3	YI3	SY3	2.0
PSC50-SER/L35060-16	SA3	5510	YE3	YI3	SY3	2.0
PSC63-SER/L45065-16	SA3	5510	YE3	YI3	SY3	2.0
PSC32-SER/L22040-22	SA4	5520	YE4	YI4	SY4	4.0
PSC40-SER/L27050-22	SA4	5520	YE4	YI4	SY4	4.0
PSC50-SER/L35060-22	SA4	5520	YE4	YI4	SY4	4.0
PSC63-SER/L45065-22	SA4	5520	YE4	YI4	SY4	4.0
PSC80-SER/L55080-22	SA4	5520	YE4	YI4	SY4	4.0

ER/L

Triangular negative inserts for external threading. C03,05,08,10

Reference	l	d
16ER/L..	0.629	0.374
22ER/L..	0.866	0.500

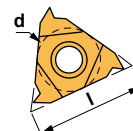



Characteristics:
Multipurpose threading boring bar for negative lay down inserts.
PSC with internal coolant.

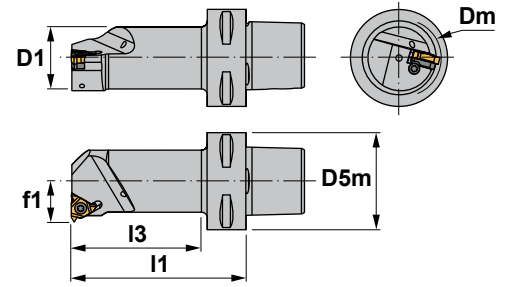
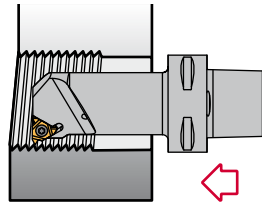

SI 90°

Reference	D1	Dm	D5m	f1	I1	I3	Insert size				R	L		Nm	
PSC32-SIR/L12050-16	0.610	0.787	1.260	0.472	1.969	1.299	16NR/L..	SN3	5510	-	-	-	-	2.0	0.460
PSC32-SIR/L22085-16	1.240	1.575	1.260	0.866	3.346	2.756	16NR/L..	SA3	5510	YI3	YE3	SY3	-	2.0	1.125
PSC40-SIR/L12060-16	0.610	0.787	1.575	0.472	2.362	1.457	16NR/L..	SN3	5510	-	-	-	-	2.0	0.660
PSC40-SIR/L14060-16	0.730	0.984	1.575	0.551	2.362	1.496	16NR/L..	SA3T	5510	YI3	YE3	SY3	-	2.0	0.750
PSC40-SIR/L17070-16	0.964	1.260	1.575	0.669	2.756	1.890	16NR/L..	SA3	5510	YI3	YE3	SY3	-	2.0	0.900
PSC40-SIR/L22090-16	1.260	1.575	1.575	0.866	3.543	2.717	16NR/L..	SA3	5510	YI3	YE3	SY3	-	2.0	1.435
PSC40-SIR/L27080-16	1.555	1.969	1.575	1.063	3.150	2.362	16NR/L..	SA3	5510	YI3	YE3	SY3	-	2.0	1.675
PSC50-SIR/L12060-16	0.610	0.787	1.969	0.472	2.362	1.378	16NR/L..	SN3	5510	-	-	-	-	2.0	1.080
PSC50-SIR/L14060-16	0.730	0.984	1.969	0.551	2.362	1.417	16NR/L..	SA3T	5510	YI3	YE3	SY3	-	2.0	1.125
PSC50-SIR/L17070-16	0.964	1.260	1.969	0.669	2.756	1.850	16NR/L..	SA3	5510	YI3	YE3	SY3	-	2.0	1.300
PSC50-SIR/L22090-16	0.964	1.575	1.969	0.866	3.543	2.677	16NR/L..	SA3	5510	YI3	YE3	SY3	-	2.0	1.810
PSC50-SIR/L27105-16	1.575	1.969	1.969	1.063	4.134	3.307	16NR/L..	SA3	5510	YI3	YE3	SY3	-	2.0	2.645
PSC63-SIR/L14070-16	0.730	0.984	2.480	0.551	2.756	1.654	16NR/L..	SA3T	5510	YI3	YE3	SY3	-	2.0	1.985
PSC63-SIR/L17075-16	0.964	1.260	2.480	0.669	2.953	1.890	16NR/L..	SA3	5510	YI3	YE3	SY3	-	2.0	2.140
PSC63-SIR/L22090-16	1.260	1.575	2.480	0.866	3.543	2.520	16NR/L..	SA3	5510	YI3	YE3	SY3	-	2.0	2.515
PSC63-SIR/L27105-16	1.575	1.969	2.480	1.063	4.134	3.150	16NR/L..	SA3	5510	YI3	YE3	SY3	-	2.0	3.310
PSC40-SIR/L15065-22	0.730	0.984	1.575	0.591	2.559	1.654	22NR/L..	SN4	5520	-	-	-	-	4.0	0.770
PSC40-SIR/L19070-22	0.984	1.260	1.575	0.748	2.756	1.890	22NR/L..	SA4	5520	YI4	YE4	SY4	-	4.0	0.925
PSC40-SIR/L22090-22	1.240	1.575	1.575	0.866	3.543	2.717	22NR/L..	SA4	5520	YI4	YE4	SY4	-	4.0	1.435
PSC40-SIR/L27080-22	1.555	1.969	1.575	1.063	3.150	2.362	22NR/L..	SA4	5520	YI4	YE4	SY4	-	4.0	1.675
PSC50-SIR/L15065-22	0.730	0.984	1.969	0.591	2.559	1.614	22NR/L..	SN4	5520	-	-	-	-	4.0	1.150
PSC50-SIR/L19070-22	0.984	1.260	1.969	0.748	2.756	1.850	22NR/L..	SA4	5520	YI4	YE4	SY4	-	4.0	1.325
PSC50-SIR/L22090-22	1.240	1.575	1.969	0.866	3.543	2.677	22NR/L..	SA4	5520	YI4	YE4	SY4	-	4.0	1.810
PSC50-SIR/L27105-22	1.575	1.969	1.969	1.063	4.134	3.307	22NR/L..	SA4	5520	YI4	YE4	SY4	-	4.0	2.645
PSC63-SIR/L19075-22	0.984	1.260	2.480	0.748	2.953	1.890	22NR/L..	SA4	5520	YI4	YE4	SY4	-	4.0	2.140
PSC63-SIR/L22090-22	1.240	1.575	2.480	0.866	3.543	2.520	22NR/L..	SA4	5520	YI4	YE4	SY4	-	4.0	2.515
PSC63-SIR/L27105-22	1.575	1.969	2.480	1.063	4.134	3.150	22NR/L..	SA4	5520	YI4	YE4	SY4	-	4.0	3.310

WARNING!! Because of large thread profile, modification may have to be made to the boring bar to achieve full depth of thread.

NR/L

Triangular negative inserts for internal threading. C04,06,07,09,10

Reference

l

d

16NR/L..

0.629

0.374

22NR/L..

0.866

0.500

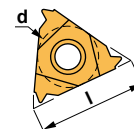

NR/L

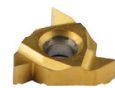

NR/L TD





Characteristics:

Parting, grooving and side turning toolholder for modular blades CZFD.
 Double-sided inserts 0.079 to 0.236 inches thickness.
 PSC with internal coolant.

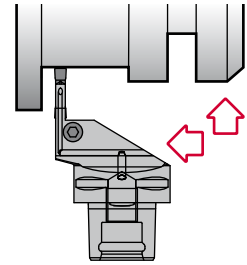
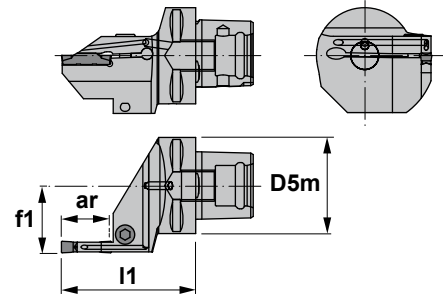

CZCD

Reference	D5m	f1	l1	ar max	Insert size			Nm	
PSC32-CZCDR/L22055-02	1.260	0.866	2.165	0.591	WDM..02	1296	5005	4.0	0.550
PSC40-CZCDR/L27055-02	1.575	1.063	2.165	0.591	WDM..02	1096	5005	4.0	0.950
PSC50-CZCDR/L35060-02	1.969	1.378	2.362	0.591	WDM..02	1096	5005	4.0	1.765
PSC32-CZCDR/L22055-03	1.260	0.866	2.165	0.787	WDM..03	1296	5005	4.0	0.550
PSC40-CZCDR/L27060-03	1.575	1.063	2.362	0.787	WDM..03	1096	5005	4.0	1.060
PSC50-CZCDR/L35060-03	1.969	1.378	2.362	0.787	WDM..03	1096	5005	4.0	1.765
PSC63-CZCDR/L45065-03	2.480	1.772	2.559	0.787	WDM..03	1096	5005	4.0	2.425
PSC32-CZCDR/L22060-04	1.260	0.866	2.362	0.787	WDM..04	1296	5005	4.0	0.575
PSC40-CZCDR/L27067-04	1.575	1.063	2.638	0.984	WDM..04	1096	5005	4.0	0.970
PSC50-CZCDR/L35067-04	1.969	1.378	2.638	0.984	WDM..04	1096	5005	4.0	1.765
PSC63-CZCDR/L45070-04	2.480	1.772	2.756	0.984	WDM..04	1096	5005	4.0	2.975
PSC40-CZCDR/L27067-05	1.575	1.063	2.638	0.984	WDM..05	1096	5005	4.0	0.970
PSC50-CZCDR/L35067-05	1.969	1.378	2.638	0.984	WDM..05	1096	5005	4.0	1.765
PSC63-CZCDR/L45070-05	2.480	1.772	2.756	0.984	WDM..05	1096	5005	4.0	2.975
PSC40-CZCDR/L27070-06	1.575	1.063	2.756	0.984	WDM..06	1096	5005	4.0	0.970
PSC50-CZCDR/L35070-06	1.969	1.378	2.756	0.984	WDM..06	1096	5005	4.0	1.720
PSC63-CZCDR/L45075-06	2.480	1.772	2.953	0.984	WDM..06	1096	5005	4.0	3.150

For modular blades CZFD, see pages B12 to B13.

WDM..

B04

Reference	T
WDM..02	0.079
WDM..03	0.118
WDM..04	0.157
WDM..05	0.197
WDM..06	0.236

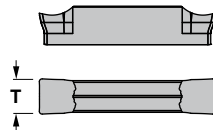

WDMG: Insert for grooving.
 WDMP: Insert for parting.
 WDMR: Insert for parting with radius.
 WDMT: Insert for turning.

WDMG

WDMP



WDMR

WDMT



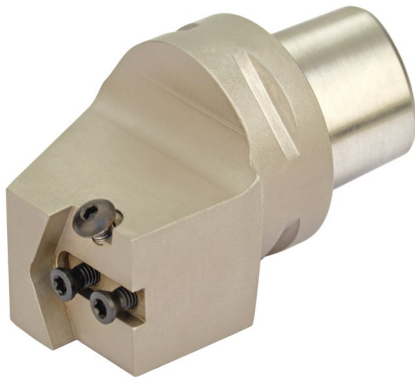

Characteristics:
 Parting, grooving and side turning toolholder for modular blades CZFD.
 Double-sided inserts 0.079 to 0.236 inches thickness.

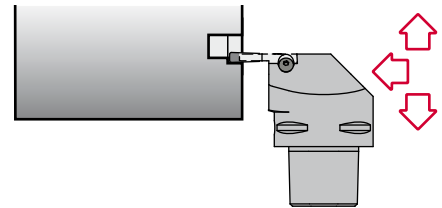
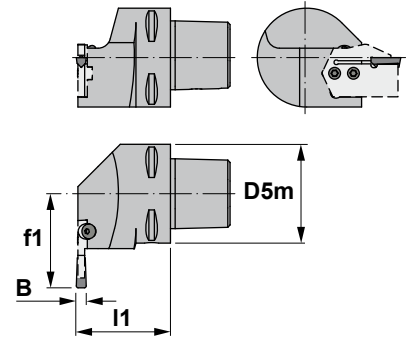

CZFD

Reference	D5m	f1	l1	B	
PSC32-CZFDR/L18040	1.260	0.708	1.574	0.079-0.236	0.550
PSC40-CZFDR/L22050	1.575	0.866	1.968	0.079-0.236	0.950
PSC50-CZFDR/L27060	1.969	1.063	2.362	0.079-0.236	1.765
PSC63-CZFDR/L34065	2.480	1.338	2.560	0.079-0.236	2.425

Reference					Nm
PSC32-CZFDR/L18040	1025	1450	5003	5520	3.0
PSC40-CZFDR/L22050	1025	1450	5003	5520	3.0
PSC50-CZFDR/L27060	1025	1450	5003	5520	3.0
PSC63-CZFDR/L34065	1025	1450	5003	5520	3.0

For modular blades CZFD, see pages B12 to B13.

Modular blades







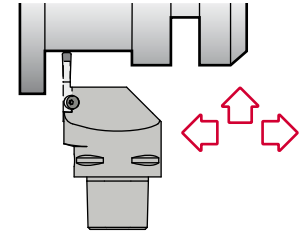
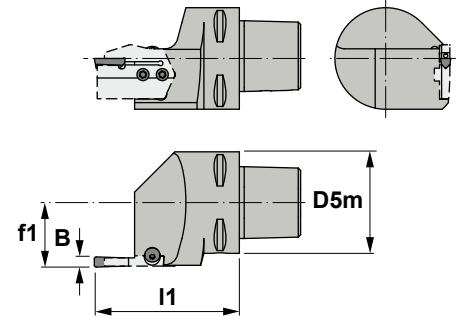

Characteristics:
Parting, grooving and side turning
toolholder for modular blades CZFD.
Double-sided inserts 0.079 to 0.236
inches thickness.



CZGD

Reference	D5m	f1	I1	B	
PSC32-CZGDR/L22042	1.260	0.866	1.653	0.079-0.236	0.550
PSC40-CZGDR/L27050	1.575	1.063	1.968	0.079-0.236	0.950
PSC50-CZGDR/L30050	1.969	1.181	1.968	0.079-0.236	1.765
PSC63-CZGDR/L45055	2.480	1.771	2.165	0.079-0.236	2.425

Reference					Nm
PSC32-CZGDR/L22042	1025	1450	5003	5520	3.0
PSC40-CZGDR/L27050	1025	1450	5003	5520	3.0
PSC50-CZGDR/L30050	1025	1450	5003	5520	3.0
PSC63-CZGDR/L45055	1025	1450	5003	5520	3.0

For modular blades CZFD, see pages B12 to B13.

Modular blades





Characteristics:
 Multipurpose grooving and threading
 top clamp toolholder.
 Right tools require left inserts and
 vice versa.
 PSC with internal coolant.

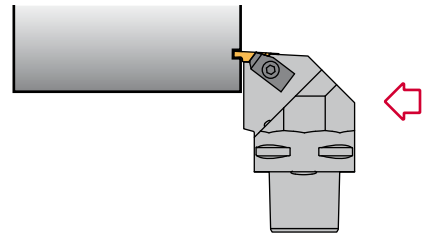
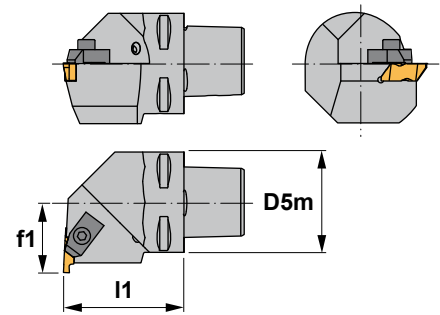

NE 93°

Reference	D5m	f1	l1	Insert size	lbs
PSC40-NER/L27050-03	1.575	1.063	1.969	N..3	0.925
PSC50-NER/L35060-03	1.969	1.378	2.362	N..3	1.765
PSC63-NER/L45065-03	2.480	1.772	2.559	N..3	2.425

Reference					Nm
PSC40-NER/L27050-03	TF-73	TF-72	5004	1495	3.5
PSC50-NER/L35060-03	TF-73	TF-72	5004	1495	3.5
PSC63-NER/L45065-03	TF-73	TF-72	5004	1495	3.5

N.. B06-07		NG	NR
Reference	T		
N..3	0.195		
NG: Insert for grooving. NR: Insert for parting with radius. NT: Insert for threading.		NT	





Characteristics:
 Specific application grooving toolholder.
 Right tools require left inserts and vice versa.
 PSC with internal coolant.

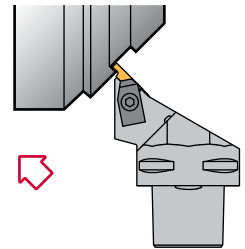
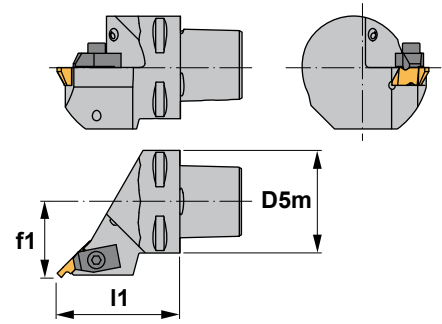

NR 45°

Reference	D5m	f1	l1	Insert size	
PSC40-NRR/L27055-03	1.575	1.063	2.165	N..3	0.950
PSC50-NRR/L35060-03	1.969	1.378	2.362	N..3	1.765
PSC63-NRR/L45065-03	2.480	1.772	2.559	N..3	2.425

Reference					Nm
PSC40-NRR/L27055-03	TF-73	TF-72	5004	1495	3.5
PSC50-NRR/L35060-03	TF-73	TF-72	5004	1495	3.5
PSC63-NRR/L45065-03	TF-73	TF-72	5004	1495	3.5

N.. B06-07	
Reference	T
N..3	0.195

NG: Insert for grooving.
 NR: Insert for parting with radius.
 NT: Insert for threading.

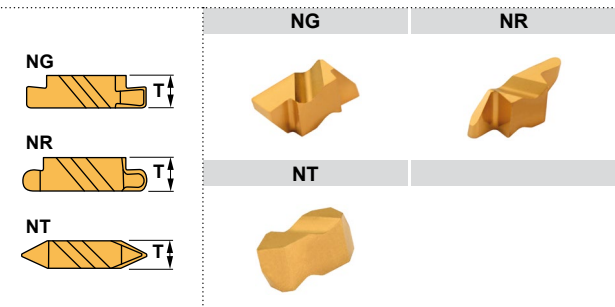

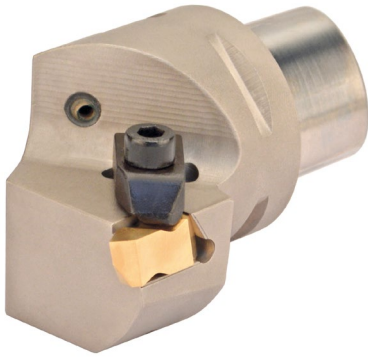

Characteristics:
 Multipurpose grooving and threading
 top clamp toolholder.
 PSC with internal coolant.

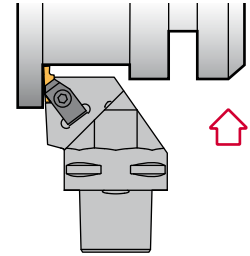
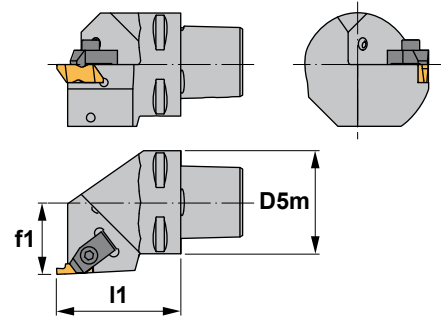

NS 93°

Reference	D5m	f1	l1	Insert size	
PSC32-NSR22040-02	1.260	0.866	1.575	N..2	1.015
PSC40-NSR/L27050-02	1.575	1.063	1.969	N..2	0.925
PSC32-NSR22045-03	1.260	0.866	1.772	N..3	0.530
PSC40-NSR/L27050-03	1.575	1.063	1.969	N..3	0.925
PSC50-NSR/L35060-03	1.969	1.378	2.362	N..3	1.765
PSC63-NSR/L45065-03	2.480	1.772	2.559	N..3	2.425
PSC40-NSR/L27055-04	1.575	1.063	2.165	N..4	0.950
PSC50-NSR/L35060-04	1.969	1.378	2.362	N..4	1.765
PSC63-NSR/L45065-04	2.480	1.772	2.559	N..4	2.425

Reference							Nm
PSC32-NSR22040-02	TF-74	TF-75	-	-	5003	1494	3.0
PSC40-NSR/L27050-02	TF-74	TF-75	-	-	5003	1494	3.0
PSC32-NSR22045-03	TF-72	TF-73	-	-	5004	1495	3.5
PSC40-NSR/L27050-03	TF-72	TF-73	-	-	5004	1495	3.5
PSC50-NSR/L35060-03	TF-72	TF-73	-	-	5004	1495	3.5
PSC63-NSR/L45065-03	TF-72	TF-73	-	-	5004	1495	3.5
PSC40-NSR/L27055-04	TF-72	TF-73	3521	1625	5004	1495	3.5
PSC50-NSR/L35060-04	TF-72	TF-73	3521	1625	5004	1495	3.5
PSC63-NSR/L45065-04	TF-72	TF-73	3521	1625	5004	1495	3.5

N..

B06-07

Reference	T
N..2	0.150
N..3	0.195
N..4	0.255

NG: Insert for grooving.
 NR: Insert for parting with radius.
 NT: Insert for threading.

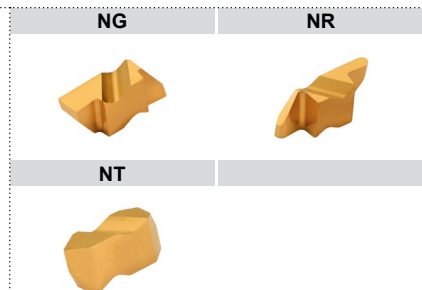
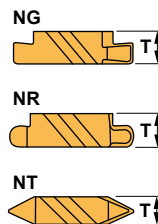



Characteristics:
 Multipurpose grooving and threading top clamp boring bar.
 Right tools require left inserts and vice versa.
 PSC with internal coolant.

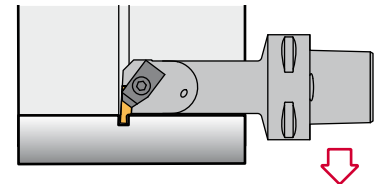
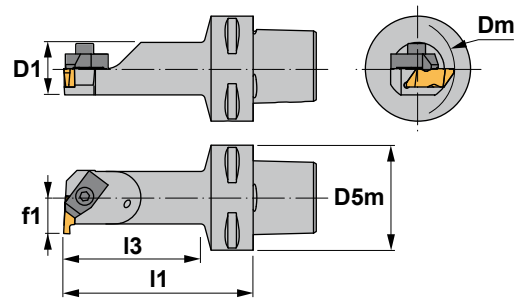

NNTO 93°

Reference	Dm	D1	D5m	f1	l1	l3	Insert size	
PSC40-NNTOR/L11070-02	0.866	0.630	1.575	0.433	2.756	1.850	N..2	0.730
PSC40-NNTOR/L13080-02	1.024	0.787	1.575	0.512	3.150	2.283	N..2	0.880
PSC50-NNTOR/L11070-02	0.866	0.630	1.969	0.433	2.756	1.811	N..2	1.100
PSC50-NNTOR/L13080-02	1.024	0.787	1.969	0.512	3.150	2.205	N..2	1.255
PSC50-NNTOR/L17090-02	1.339	0.984	1.969	0.669	3.543	2.638	N..2	1.545
PSC40-NNTOR/L17090-03	1.339	0.984	1.575	0.669	3.543	2.717	N..3	1.060
PSC50-NNTOR/L17090-03	1.339	0.984	1.969	0.669	3.543	2.638	N..3	1.545
PSC50-NNTOR/L22110-03	1.732	1.260	1.969	0.866	4.331	3.465	N..3	2.050
PSC63-NNTOR/L27140-04	2.126	1.575	2.480	1.063	5.512	4.528	N..4	3.925
PSC63-NNTOR/L35175-04	2.756	1.969	2.480	1.378	6.890	5.984	N..4	6.285

Reference					Nm
PSC40-NNTOR/L11070-02	TF-147	TF-146	5003	1494	3.0
PSC40-NNTOR/L13080-02	TF-75	TF-146	5003	1494	3.0
PSC50-NNTOR/L11070-02	TF-75	TF-146	5003	1494	3.0
PSC50-NNTOR/L13080-02	TF-75	TF-146	5003	1494	3.0
PSC50-NNTOR/L17090-02	TF-75	TF-146	5003	1494	3.0
PSC40-NNTOR/L17090-03	TF-73	TF-72	5004	1495	3.5
PSC50-NNTOR/L17090-03	TF-73	TF-72	5004	1495	3.5
PSC50-NNTOR/L22110-03	TF-73	TF-72	5004	1495	3.5
PSC63-NNTOR/L27140-04	TF-73	TF-72	5004	1495	3.5
PSC63-NNTOR/L35175-04	TF-73	TF-72	5004	1495	3.5

N..

B06-07

Reference	T
N..2	0.150
N..3	0.195
N..4	0.255

NG: Insert for grooving.
 NR: Insert for parting with radius.
 NT: Insert for threading.

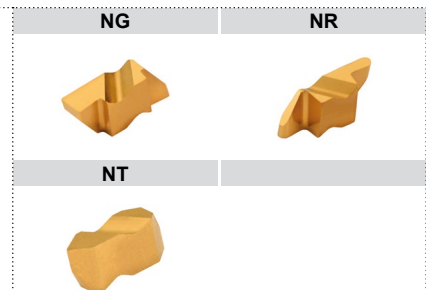
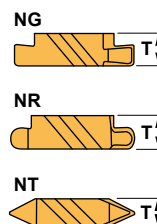



Characteristics:

Helical flute indexable insert drills provide faster cutting speeds and efficient chip removal for use on conventional and C.N.C. machines. This type of drills incorporates a neutral-rake geometry and screw-down square inserts for stability and clean through-hole putting. PSC with internal coolant. Max. hole depth = 3xDiameter (D)

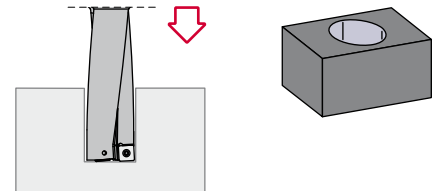
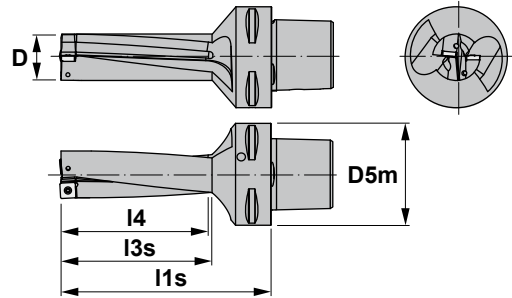

45..

Reference	D5m	D	l1s	l3s	l4	Radial Adj. Dmax	Insert size		Nm	
PSC40-451415	1.575	0.591	3.228	1.890	1.772	+0,40↻15,8	SPMT0603..	1225 5507	0.9	0.730
PSC40-451416	1.575	0.630	3.386	2.008	1.890	+0,30↻16,6	SPMT0603..	1225 5507	0.9	0.795
PSC40-451417	1.575	0.669	3.504	2.126	2.008	+0,60↻18,2	SPMT0603..	1225 5507	0.9	0.815
PSC40-451417,5	1.575	0.689	3.622	2.205	2.087	+0,50↻18,5	SPMT0603..	1225 5507	0.9	0.840
PSC40-451418	1.575	0.709	3.661	2.244	2.126	+0,40↻18,8	SPMT0603..	1225 5507	0.9	0.860
PSC40-451418,5	1.575	0.728	3.740	2.323	2.205	+0,40↻19,3	SPMT0603..	1225 5507	0.9	0.880
PSC40-451419	1.575	0.748	3.780	2.362	2.244	+0,30↻19,6	SPMT0603..	1225 5507	0.9	0.905
PSC40-451420	1.575	0.787	3.976	2.520	2.362	+0,90↻21,8	SPMT0603..	1225 5507	0.9	0.970
PSC40-452421	1.575	0.827	4.114	2.598	2.480	+0,80↻22,6	SPMT0703..	1225 5507	0.9	1.015
PSC40-452422	1.575	0.866	4.213	2.717	2.598	+0,60↻23,2	SPMT0703..	1225 5507	0.9	1.080
PSC40-452423	1.575	0.906	4.370	2.835	2.717	+0,50↻24,0	SPMT0703..	1225 5507	0.9	1.145
PSC40-452424	1.575	0.945	4.528	2.992	2.835	+1,10↻26,2	SPMT0703..	1225 5507	0.9	1.235
PSC40-452425	1.575	0.984	4.685	3.110	2.953	+1,00↻27,0	SPMT0703..	1225 5507	0.9	1.300
PSC40-453426	1.575	1.024	4.803	3.189	3.071	+0,90↻27,8	SPMT0903..	1230 5508	1.2	1.410
PSC40-453427	1.575	1.063	4.921	3.307	3.189	+0,70↻28,4	SPMT0903..	1230 5508	1.2	1.500
PSC40-453428	1.575	1.102	5.079	3.425	3.307	+0,60↻29,2	SPMT0903..	1230 5508	1.2	1.590
PSC40-453429	1.575	1.142	5.197	3.543	3.425	+0,50↻30,0	SPMT0903..	1230 5508	1.2	1.675
PSC40-453430	1.575	1.181	5.393	3.701	3.543	+1,12↻32,2	SPMT0903..	1230 5508	1.2	1.785

SPMT

Square positive insert with 11° clearance. H02

Reference	l	T	d
SPMT060304	0.250	0.125	0.250
SPMT070308	0.312	0.125	0.312
SPMT090308	0.374	0.125	0.374

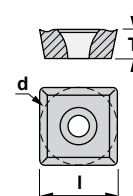

SPMT





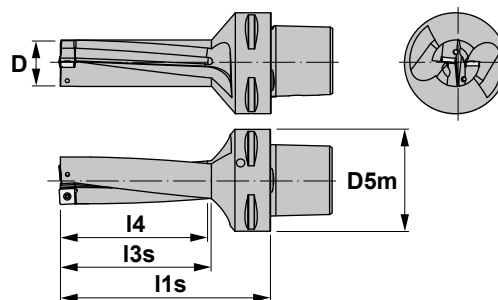

Characteristics:

Helical flute indexable insert drills provide faster cutting speeds and efficient chip removal for use on conventional and C.N.C. machines.



45..



Reference	D5m	D	l1s	l3s	l4	Radial Adj. Dmax	Insert size		Nm	
PSC50-451415	1.969	0.591	3.228	1.890	1.772	+0,40↔15,8	SPMT0603..	1225 5507	0.9	1.280
PSC50-451416	1.969	0.630	3.386	2.008	1.890	+0,30↔16,6	SPMT0603..	1225 5507	0.9	1.300
PSC50-451417	1.969	0.669	3.504	2.126	2.008	+0,60↔18,2	SPMT0603..	1225 5507	0.9	1.325
PSC50-451417,5	1.969	0.689	3.622	2.205	2.087	+0,50↔18,5	SPMT0603..	1225 5507	0.9	1.325
PSC50-451418	1.969	0.709	3.661	2.244	2.126	+0,40↔18,8	SPMT0603..	1225 5507	0.9	1.325
PSC50-451418,5	1.969	0.728	3.740	2.323	2.205	+0,40↔19,3	SPMT0603..	1225 5507	0.9	1.325
PSC50-451419	1.969	0.748	3.780	2.362	2.244	+0,30↔19,6	SPMT0603..	1225 5507	0.9	1.345
PSC50-451420	1.969	0.787	3.976	2.520	2.362	+0,90↔21,8	SPMT0603..	1225 5507	0.9	1.410
PSC50-452421	1.969	0.827	4.114	2.598	2.480	+0,80↔22,6	SPMT0703..	1225 5507	0.9	1.435
PSC50-452422	1.969	0.866	4.213	2.717	2.598	+0,60↔23,2	SPMT0703..	1225 5507	0.9	1.480
PSC50-452423	1.969	0.906	4.370	2.835	2.717	+0,50↔24,0	SPMT0703..	1225 5507	0.9	1.545
PSC50-452424	1.969	0.945	4.528	2.992	2.835	+1,10↔26,2	SPMT0703..	1225 5507	0.9	1.630
PSC50-452425	1.969	0.984	4.685	3.110	2.953	+1,00↔27,0	SPMT0703..	1225 5507	0.9	1.720
PSC50-453426	1.969	1.024	4.803	3.189	3.071	+0,90↔27,8	SPMT0903..	1230 5508	1.2	1.810
PSC50-453427	1.969	1.063	4.921	3.307	3.189	+0,70↔28,4	SPMT0903..	1230 5508	1.2	1.810
PSC50-453428	1.969	1.102	5.079	3.425	3.307	+0,60↔29,2	SPMT0903..	1230 5508	1.2	1.985
PSC50-453429	1.969	1.142	5.197	3.543	3.425	+0,50↔30,0	SPMT0903..	1230 5508	1.2	2.095
PSC50-453430	1.969	1.181	5.393	3.701	3.543	+1,12↔32,2	SPMT0903..	1230 5508	1.2	2.225
PSC50-453431	1.969	1.220	5.551	3.819	3.661	+0,99↔33,0	SPMT0903..	1230 5508	1.2	2.340
PSC50-453432	1.969	1.260	5.669	3.937	3.780	+0,87↔33,7	SPMT0903..	1230 5508	1.2	2.450
PSC50-453433	1.969	1.299	5.827	4.055	3.898	+0,75↔34,5	SPMT0903..	1230 5508	1.2	2.600
PSC50-453434	1.969	1.339	5.945	4.173	4.016	+0,62↔35,2	SPMT0903..	1230 5508	1.2	2.780
PSC50-454435	1.969	1.378	6.102	4.291	4.134	+0,50↔36,0	SPMT1204..	1250 5520	4.0	2.935
PSC50-454436	1.969	1.417	6.260	4.429	4.252	+1,38↔38,8	SPMT1204..	1250 5520	4.0	3.130
PSC50-454437	1.969	1.457	6.378	4.528	4.370	+1,25↔39,5	SPMT1204..	1250 5520	4.0	3.240
PSC50-454438	1.969	1.496	6.535	4.665	4.488	+1,13↔40,2	SPMT1204..	1250 5520	4.0	3.485
PSC50-454439	1.969	1.535	6.653	4.763	4.606	+1,00↔41,0	SPMT1204..	1250 5520	4.0	3.615
PSC50-454440	1.969	1.575	6.811	4.882	4.724	+0,88↔41,8	SPMT1204..	1250 5520	4.0	4.500
PSC50-454441	1.969	1.614	6.970	5.000	4.843	+0,75↔42,5	SPMT1204..	1250 5520	4.0	4.500
PSC50-454442	1.969	1.654	7.322	5.118	4.961	+0,63↔43,2	SPMT1204..	1250 5520	4.0	4.500
PSC50-454443	1.969	1.693	7.480	5.236	5.079	+0,50↔44,0	SPMT1204..	1250 5520	4.0	4.740

SPMT

Square positive insert with 11° clearance.  H02

Reference	l	T	d
SPMT060304	0.250	0.125	0.250
SPMT070308	0.312	0.125	0.312
SPMT090308	0.374	0.125	0.374
SPMT120408	0.500	0.187	0.500

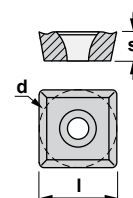

SPMT





Characteristics:
Helical flute indexable insert drills provide faster cutting speeds and efficient chip removal for use on conventional and C.N.C. machines.

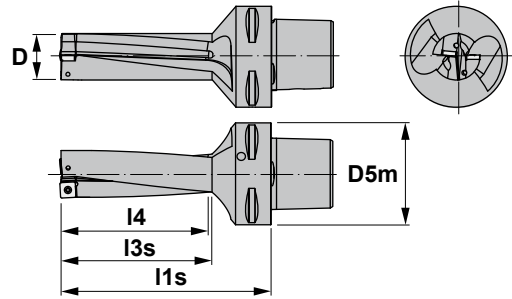

45..

Reference	D5m	D	l1s	l3s	l4	Radial Adj. Dmax	Insert size			Nm	
PSC63-451415	2.480	0.591	3.307	1.890	1.772	+0,40↔15,8	SPMT0603..	1225	5507	0.9	1.850
PSC63-451416	2.480	0.630	3.465	2.008	1.890	+0,30↔16,6	SPMT0603..	1225	5507	0.9	1.895
PSC63-451417	2.480	0.669	3.583	2.126	2.008	+0,60↔18,2	SPMT0603..	1225	5507	0.9	1.920
PSC63-451417,5	2.480	0.689	3.701	2.205	2.087	+0,50↔18,5	SPMT0603..	1225	5507	0.9	1.940
PSC63-451418	2.480	0.709	3.740	2.244	2.126	+0,40↔18,8	SPMT0603..	1225	5507	0.9	1.940
PSC63-451418,5	2.480	0.728	3.819	2.323	2.205	+0,40↔19,3	SPMT0603..	1225	5507	0.9	1.985
PSC63-451419	2.480	0.748	3.858	2.362	2.244	+0,30↔19,6	SPMT0603..	1225	5507	0.9	1.985
PSC63-451420	2.480	0.787	4.055	2.520	2.362	+0,90↔21,8	SPMT0603..	1225	5507	0.9	2.050
PSC63-452421	2.480	0.827	4.173	2.598	2.480	+0,80↔22,6	SPMT0703..	1225	5507	0.9	2.115
PSC63-452422	2.480	0.866	4.291	2.717	2.598	+0,60↔23,2	SPMT0703..	1225	5507	0.9	2.140
PSC63-452423	2.480	0.906	4.449	2.835	2.717	+0,50↔24,0	SPMT0703..	1225	5507	0.9	2.225
PSC63-452424	2.480	0.945	4.606	2.992	2.835	+1,10↔26,2	SPMT0703..	1225	5507	0.9	2.295
PSC63-452425	2.480	0.984	4.763	3.110	2.953	+1,00↔27,0	SPMT0703..	1225	5507	0.9	2.380
PSC63-453426	2.480	1.024	4.882	3.189	3.071	+0,90↔27,8	SPMT0903..	1230	5508	1.2	2.470
PSC63-453427	2.480	1.102	5.000	3.307	3.189	+0,70↔28,4	SPMT0903..	1230	5508	1.2	2.560
PSC63-453428	2.480	1.102	5.173	3.425	3.307	+0,60↔29,2	SPMT0903..	1230	5508	1.2	2.670
PSC63-453429	2.480	1.142	5.275	3.543	3.425	+0,50↔30,0	SPMT0903..	1230	5508	1.2	2.780
PSC63-453430	2.480	1.181	5.472	3.701	3.543	+1,12↔32,2	SPMT0903..	1230	5508	1.2	2.910
PSC63-453431	2.480	1.220	5.630	3.819	3.661	+0,99↔33,0	SPMT0903..	1230	5508	1.2	3.020
PSC63-453432	2.480	1.260	5.748	3.937	3.780	+0,87↔33,7	SPMT0903..	1230	5508	1.2	3.150
PSC63-453433	2.480	1.299	5.906	4.055	3.898	+0,75↔34,5	SPMT0903..	1230	5508	1.2	3.305
PSC63-453434	2.480	1.339	6.023	4.173	4.016	+0,62↔35,2	SPMT0903..	1230	5508	1.2	3.440
PSC63-454435	2.480	1.378	6.181	4.291	4.134	+0,50↔36,0	SPMT1204..	1250	5520	4.0	3.595
PSC63-454436	2.480	1.417	6.339	4.429	4.252	+1,38↔38,8	SPMT1204..	1250	5520	4.0	3.770
PSC63-454437	2.480	1.457	6.456	4.528	4.370	+1,25↔39,5	SPMT1204..	1250	5520	4.0	3.950
PSC63-454438	2.480	1.496	6.614	4.665	4.488	+1,13↔40,2	SPMT1204..	1250	5520	4.0	4.145
PSC63-454439	2.480	1.535	6.732	4.763	4.606	+1,00↔41,0	SPMT1204..	1250	5520	4.0	4.275
PSC63-454440	2.480	1.575	6.890	4.882	4.724	+0,88↔41,8	SPMT1204..	1250	5520	4.0	4.500
PSC63-454441	2.480	1.614	7.047	5.000	4.843	+0,75↔42,5	SPMT1204..	1250	5520	4.0	4.760
PSC63-454442	2.480	1.654	7.165	5.118	4.961	+0,63↔43,2	SPMT1204..	1250	5520	4.0	5.005
PSC63-454443	2.480	1.693	7.322	5.236	5.079	+0,50↔44,0	SPMT1204..	1250	5520	4.0	5.180

SPMT

Square positive insert with 11° clearance. H02

Reference	l	T	d
SPMT060304	0.250	0.125	0.250
SPMT070308	0.312	0.125	0.312
SPMT090308	0.374	0.125	0.374
SPMT120408	0.500	0.187	0.500

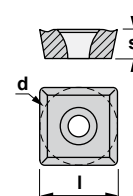

SPMT



CANELA also offers a full range of adapters.

13
ISO 7388
DIN 69871/A

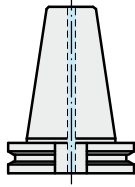

16
HSK
DIN 69893-1

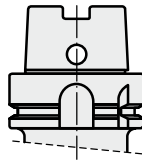

23
ISO
JIS B 6339-BT

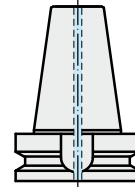

18.218

EXTENSION

REDUCER

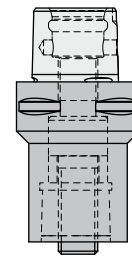
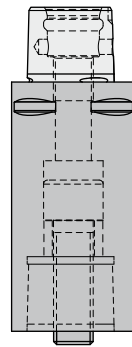

18.160

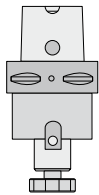

18.215

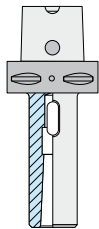

18.296

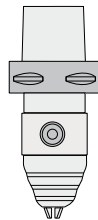

18.306

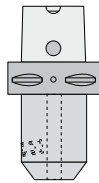

18.315

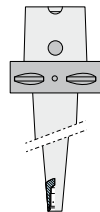

18.400

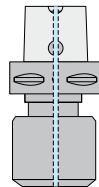

18.406

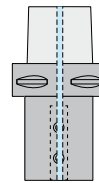

18.453

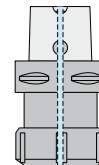

18.455

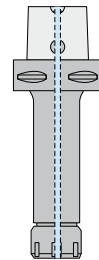

18.470

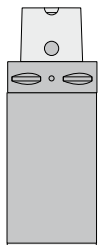

18.500

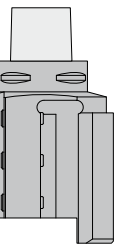

18.510

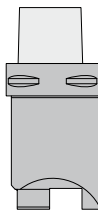

18.520

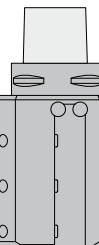

18.530

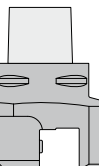

18.540

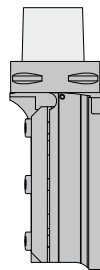

18.550

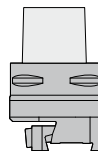

18.620

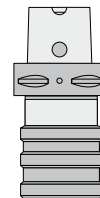

18.999

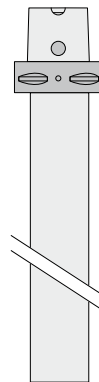

Code system

18	160	050	0125
1	2	3	4

1 Model

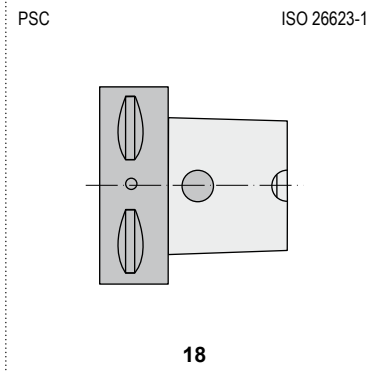

2 Arbor type

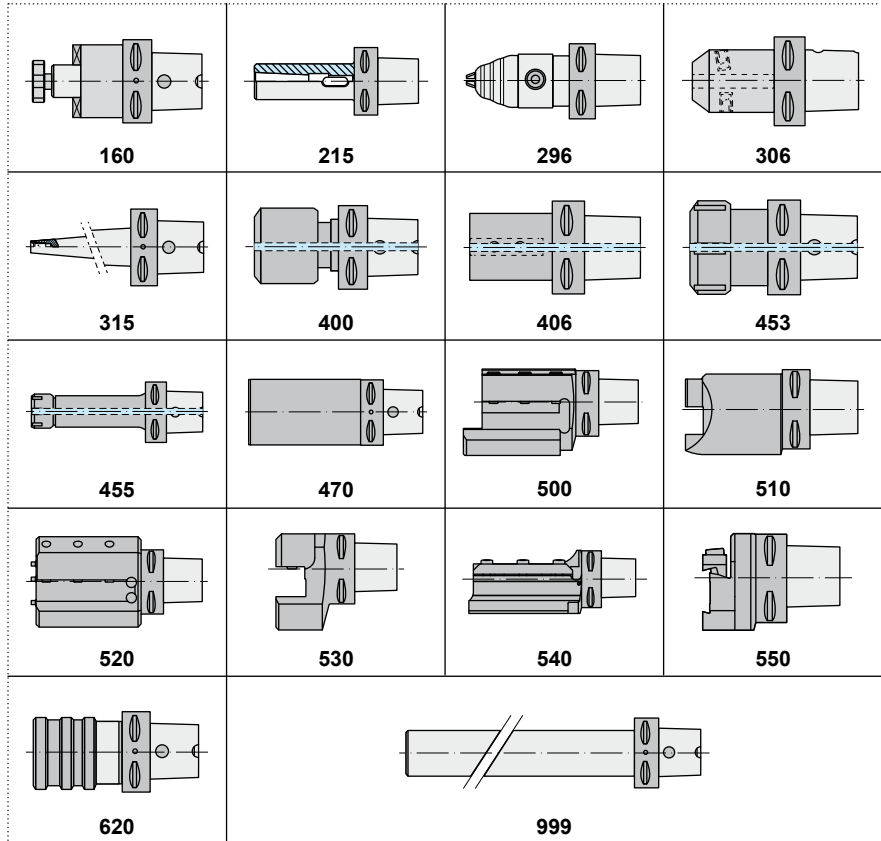

3 Arbor size

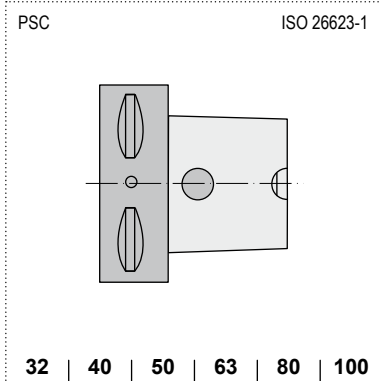

4 Adaptor size

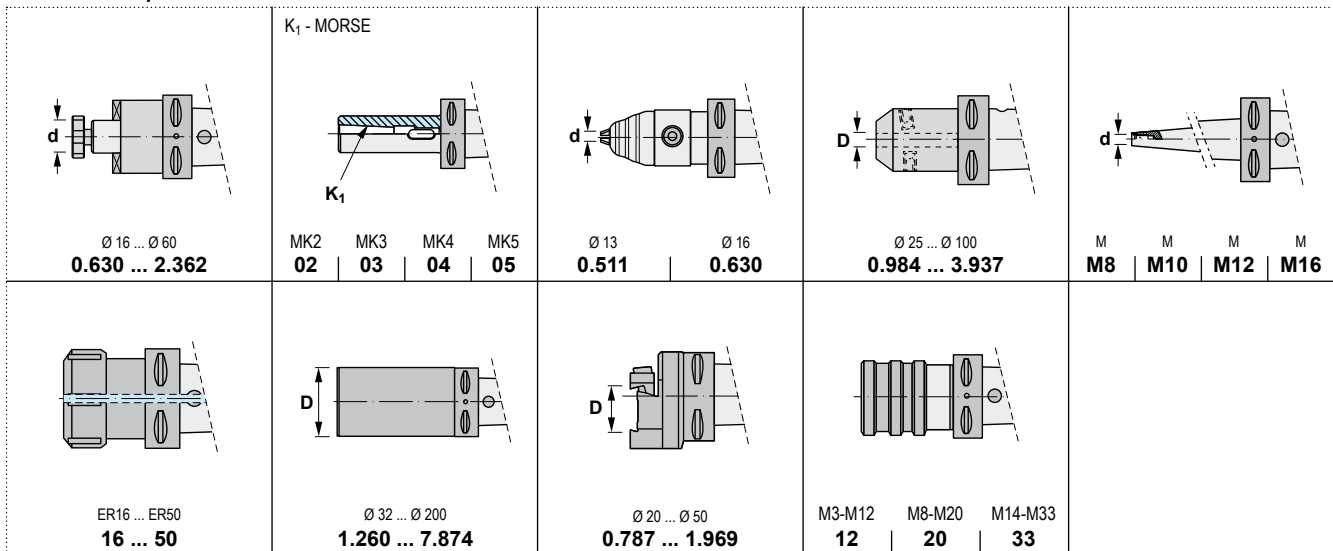

AT3 TECHNICAL CHARACTERISTICS OF THE TOOLHOLDERS

MATERIAL:

- Chromium-manganese carburised steel 1.7131 (16MnCr5).

EXECUTION:

- Carburised, hardened and tempered.
- Surface hardness HRC 58±2 (670±40 HV30)
- Depth of carburised layer minimum 0.020 inches.
- Tensile strength in core minimum 800 N/mm2 after carburizing.

ACCURACY:

- Taper according to DIN 254
- Taper angle: tolerance AT 3 DIN 7178 part 1 and DIN 2080 part 1.
- Other tolerances according to DIN 7160 and 7168.
- Taper surface roughness RZ<0.039 inches.

TOLERANCE AT:

- Indicates the tolerance of measuring plane D between the real and the theoretical value of the taper conicity.
- This value of measuring plane D must always be less (negative), never more (positive) in order to GUARANTEE a good toolholder fixation at the bigger taper diameter.

K	AT3 mm
ISO 30	0,002
ISO 40	0,003
ISO 45	0,003
ISO 50	0,004
ISO 60	0,005

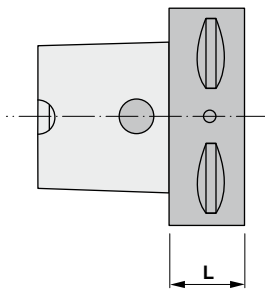

18 PSC ISO 26623-1

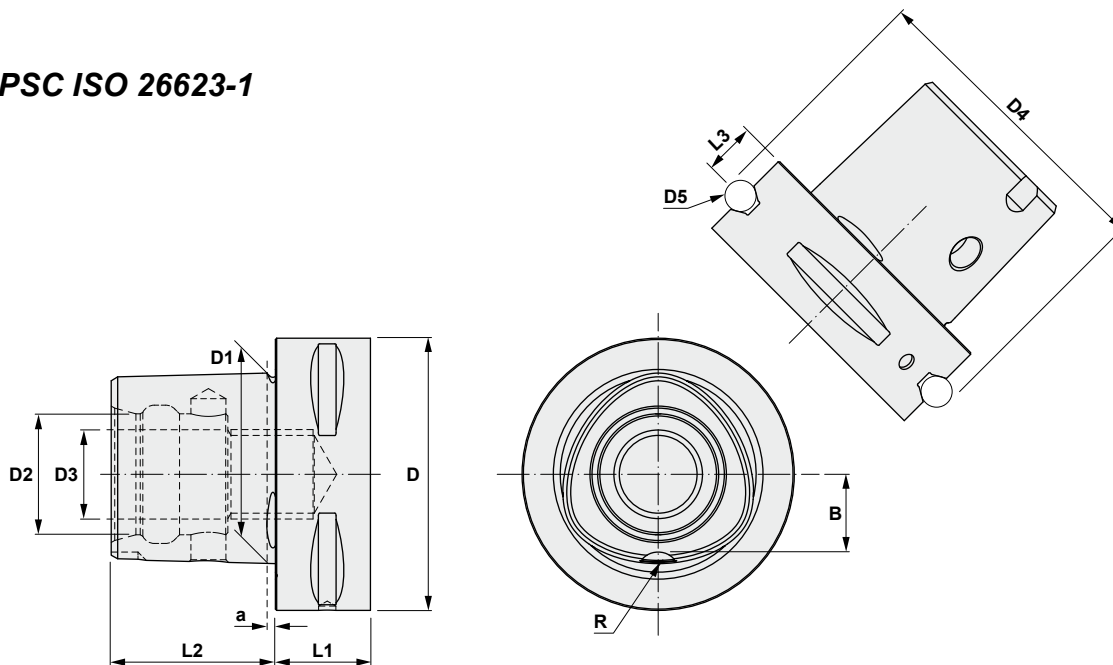

PSC	D	D1	D2	D3	D4	D5	L1 min	L2	L3	a	B	R
32	1.260	0.866	0.591	M12 x 1,5	1.535	0.197	0.591	0.748	0.236	0.096	0.354	0.118
40	1.575	1.102	0.709	M14 x 1,5	1.811	0.197	0.787	0.945	0.315	0.096	0.433	0.118
50	1.969	1.378	0.827	M16 x 1,5	2.335	0.276	0.787	1.181	0.394	0.118	0.551	0.157
63	2.480	1.732	1.102	M20 x 2,0	2.783	0.276	0.866	1.496	0.472	0.118	0.709	0.197
80	3.150	2.165	1.260	M20 x 2,0	3.386	0.276	1.181	1.890	0.472	0.118	0.874	0.236
100	3.937	2.835	1.693	M24 x 2,0	4.331	0.394	1.260	2.362	0.630	0.118	1.150	0.236

Arbors and adaptors PSC ISO 26623-1

<p>18.160</p>  <p>Page E84-85</p>	<p>18.215</p>  <p>Page E86</p>	<p>18.296</p>  <p>Page E87</p>	<p>18.306</p>  <p>Page E88-89</p>	<p>18.315</p>  <p>Page E90</p>
<p>18.400</p>  <p>Page E92-93</p>	<p>18.406</p>  <p>Page E94-95</p>	<p>18.453</p>  <p>Page E96</p>	<p>18.455</p>  <p>Page E97</p>	<p>18.470</p>  <p>Page E98</p>
<p>18.500</p>  <p>Page E100-101</p>	<p>18.510</p>  <p>Page E102-103</p>	<p>18.520</p>  <p>Page E104-105</p>	<p>18.530</p>  <p>Page E106-107</p>	<p>18.540</p>  <p>Page E108</p>
<p>18.550</p>  <p>Page E109</p>	<p>18.620</p>  <p>Page E110</p>	<p>18.999</p>  <p>Page E111</p>		
<p>13.218</p>  <p>Page E112</p>	<p>16.218</p>  <p>Page E113</p>	<p>18.218 Extension</p>  <p>Page E114</p>	<p>18.218 Reducer</p>  <p>Page E115</p>	<p>23.218</p>  <p>Page E116</p>
<p>MC</p>  <p>Page E117</p>	<p>AC</p>  <p>Page E117</p>			







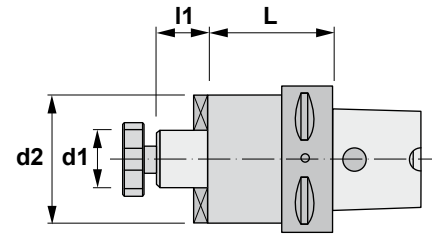
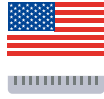

Characteristics:
Shell mill adaptor.
PSC ISO 26623-1
For cutters with driving slot DIN 138.



18.160





Reference	PSC	d1 h6	L	l1	d2				
18.160.040.0075	40	0.750	0.984	0.709	1.575	10107	86207	11103	1.235
18.160.040.0100	40	1.000	1.378	0.709	1.968	10110	86210	11004	1.700
18.160.050.0075	50	0.750	0.984	0.709	1.693	10107	86207	11103	2.250
18.160.050.0100	50	1.000	0.984	0.709	2.126	10110	86210	11004	1.140
18.160.050.0125	50	1.250	1.575	0.709	2.480	10112	86212	11105	1.320
18.160.050.0150	50	1.500	1.772	0.906	3.150	10115	86215	11006	1.810
18.160.063.0075	63	0.750	1.181	0.709	2.047	10107	86207	11103	1.875
18.160.063.0100	63	1.000	1.181	0.709	2.480	10110	86210	11004	1.900
18.160.063.0125	63	1.250	1.181	0.709	2.559	10112	86212	11105	1.965
18.160.063.0150	63	1.500	1.969	0.906	3.150	10115	86215	11006	3.900
18.160.080.0075	80	0.750	1.181	0.709	2.047	10107	86207	11103	3.880
18.160.080.0100	80	1.000	1.181	0.709	2.480	10110	86210	11004	3.950
18.160.080.0125	80	1.250	1.181	0.709	2.835	10112	86212	11105	4.035
18.160.080.0150	80	1.500	2.362	0.906	3.150	10115	86215	11006	5.250

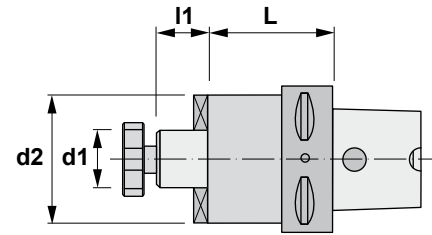

Characteristics:
Shell mill adaptor.
PSC ISO 26623-1
For cutters with driving slot DIN 138.



18.160

Reference	PSC	d1 h6	L	l1	d2				
18.160.040.16	40	0.630	2.165	0.669	1.457	10008	86016	11103	1.235
18.160.040.22	40	0.866	2.165	0.748	1.850	10010	86022	11004	1.700
18.160.050.16	50	0.630	2.362	0.669	1.457	10008	86016	11103	1.720
18.160.050.22	50	0.866	2.362	0.748	1.850	10010	86022	11004	2.250
18.160.050.27	50	1.063	2.362	0.827	2.283	10012	86027	11005	2.800
18.160.050.32	50	1.260	2.362	0.945	2.480	10016	86032	11105	3.310
18.160.063.16	63	0.630	2.480	0.669	1.457	10008	86016	11103	2.360
18.160.063.22	63	0.866	0.984	0.748	1.850	10010	86122	11004	1.810
18.160.063.22/100	63	0.866	3.937	0.748	1.850	10010	86022	11004	3.990
18.160.063.27	63	1.063	0.984	0.827	2.283	10012	86127	11005	1.875
18.160.063.27/100	63	1.063	3.937	0.827	2.283	10012	86027	11005	5.270
18.160.063.32	63	1.260	0.984	0.945	2.480	10016	86132	11105	1.965
18.160.063.32/100	63	1.260	3.937	0.945	2.480	10016	86032	11105	5.975
18.160.063.40	63	1.575	1.575	1.063	3.504	10020	80040	11006	3.900
18.160.063.40/100	63	1.575	3.937	1.063	2.756	10020	86040	11006	7.120
18.160.080.16	80	0.630	1.969	0.669	1.457	10008	86016	11103	4.190
18.160.080.22	80	0.866	1.181	0.748	1.850	10010	86122	11004	3.880
18.160.080.22/100	80	0.866	3.937	0.748	1.850	10010	86022	11004	5.975
18.160.080.27	80	1.063	1.181	0.827	2.283	10012	86127	11005	3.950
18.160.080.27/100	80	1.063	3.937	0.827	2.283	10012	86027	11005	7.145
18.160.080.32	80	1.260	1.181	0.945	2.480	10016	86132	11105	4.035
18.160.080.32/100	80	1.260	3.937	0.945	2.480	10016	86032	11105	7.785
18.160.080.40	80	1.575	1.575	1.063	2.480	10020	86140	11006	5.250
18.160.080.40/100	80	1.575	3.937	1.063	2.756	10020	86040	11006	8.820
18.160.080.60	80	2.362	2.362	1.575	5.118	-	80060	11012	11.950
18.160.100.16	100	0.630	1.969	0.669	1.457	10008	86016	11103	7.190
18.160.100.22	100	0.866	1.969	0.748	1.850	10010	86022	11004	7.450
18.160.100.22/100	100	0.866	3.937	0.748	1.850	10010	86022	11004	8.930
18.160.100.27	100	1.063	1.969	0.827	2.283	10012	86027	11005	7.785
18.160.100.27/100	100	1.063	3.937	0.827	2.283	10012	86027	11005	10.055
18.160.100.32	100	1.260	1.969	0.945	2.480	10016	86032	11105	8.575
18.160.100.32/100	100	1.260	3.937	0.945	2.480	10016	86032	11105	12.920
18.160.100.40	100	1.575	1.969	1.063	2.480	10020	86040	11006	8.775
18.160.100.40/100	100	1.575	3.937	1.063	2.480	10020	86040	11006	13.095
18.160.100.60	100	2.362	2.756	1.575	5.118	-	80060	11012	16.780



Characteristics:
 Reducing adaptor.
 PSC ISO 26623-1
 For tools with Morse taper shank
 and tang DIN 228-B. Form B.

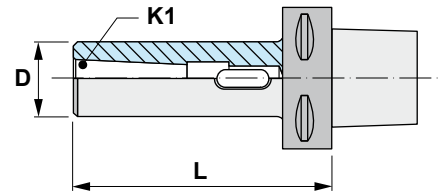

18.215

Reference	PSC	K1 MORSE	L	D	
18.215.050.02	50	2	4.331	1.260	1.895
18.215.050.03	50	3	5.118	1.575	2.710
18.215.063.02	63	2	4.331	1.260	2.515
18.215.063.03	63	3	5.118	1.575	3.310
18.215.063.04	63	4	5.906	2.047	4.960
18.215.080.03	80	3	4.724	1.575	5.160
18.215.080.04	80	4	5.512	2.047	6.570
18.215.080.05	80	5	6.299	2.480	7.675
18.215.100.03	100	3	5.118	1.575	8.335
18.215.100.04	100	4	5.906	2.047	9.875
18.215.100.05	100	5	6.890	2.480	11.310





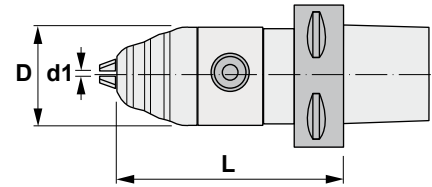

Characteristics:
CNC-Universal precision drill chucks.
PSC ISO 26623-1
For left and right hand turn.

*** SUPPLIED WITH WRENCH**



18.296

Reference	PSC	d1	D	L	
18.296.040.13	40	0.020 - 0.512	1.969	4.409	3.440
18.296.050.13	50	0.020 - 0.512	1.969	4.409	3.815
18.296.063.13	63	0.020 - 0.512	1.969	4.409	5.115
18.296.063.16	63	0.118 - 0.630	2.244	4.409	5.180
18.296.080.13	80	0.020 - 0.512	1.969	4.921	6.680
18.296.080.16	80	0.118 - 0.630	2.244	4.921	7.230
18.296.100.13	100	0.020 - 0.512	1.969	5.315	9.370
18.296.100.16	100	0.118 - 0.630	2.244	5.315	9.700



Reference		3x 
18.296.040.13	50706	60313
18.296.050.13	50706	60313
18.296.063.13	50706	60313
18.296.063.16	50706	60313
18.296.080.13	50706	60313
18.296.080.16	50706	60313
18.296.100.13	50706	60313
18.296.100.16	50706	60313

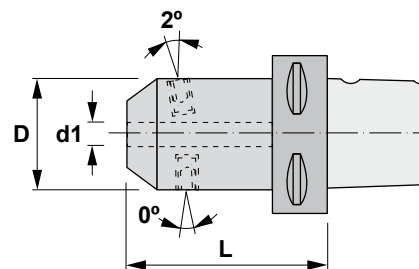
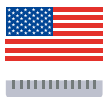

Characteristics:
 Combined end mill adaptors type Weldon / Whistle-Notch. PSC ISO 26623-1
 For tools with cylindrical shank and tightening inclined flat DIN 1835-B+E.



18.306

Reference	PSC	d1	L	D	2x 	
18.306.040.0037	40	0.375	2.008	1.000	15403	0.815
18.306.040.0050	40	0.500	2.205	1.248	15405	1.255
18.306.040.0062	40	0.625	2.165	1.614	15406	1.435
18.306.040.0075	40	0.750	2.362	1.752	15407	1.650
18.306.050.0037	50	0.375	2.165	1.000	15403	1.280
18.306.050.0050	50	0.500	2.362	1.248	15405	1.610
18.306.050.0062	50	0.625	2.362	1.614	15406	1.920
18.306.050.0075	50	0.750	2.362	1.752	15407	2.160
18.306.050.0087	50	0.875	2.953	1.969	15408	2.250
18.306.050.0100	50	1.000	3.347	2.248	4 x 15410	3.570
18.306.050.0125	50	1.250	3.347	2.480	4 x 15410	3.680
18.306.063.0037	63	0.375	2.362	1.000	15403	2.120
18.306.063.0050	63	0.500	2.362	1.248	15405	2.425
18.306.063.0062	63	0.625	2.560	1.614	15406	2.820
18.306.063.0075	63	0.750	2.560	1.752	15407	2.910
18.306.063.0087	63	0.875	3.150	1.969	15408	3.150
18.306.063.0100	63	1.000	3.347	2.248	4 x 15410	4.585
18.306.063.0125	63	1.250	3.347	2.480	4 x 15410	4.610
18.306.063.0150	63	1.500	3.543	2.756	4 x 15414	4.825
18.306.080.0037	80	0.375	2.756	1.000	15403	4.190
18.306.080.0050	80	0.500	2.756	1.248	15405	4.280
18.306.080.0062	80	0.625	2.756	1.614	15406	4.875
18.306.080.0075	80	0.750	2.953	1.752	15407	5.140
18.306.080.0087	80	0.875	3.150	1.969	15408	5.290
18.306.080.0100	80	1.000	3.150	2.248	4 x 15410	6.635
18.306.080.0125	80	1.250	3.150	2.480	4 x 15410	6.840
18.306.080.0150	80	1.500	3.347	2.756	4 x 15414	7.030
18.306.080.0200	80	2.000	4.528	3.681	4 x 15420	8.290





Characteristics:
 Combined end mill adaptors type Weldon /
 Whistle-Notch. PSC ISO 26623-1
 For tools with cylindrical shank and
 tightening inclined flat DIN 1835-B+E.

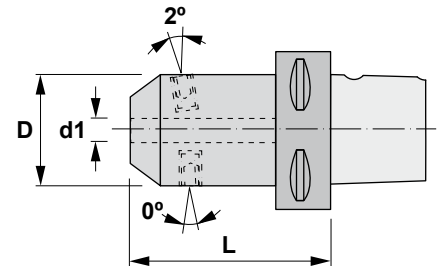

18.306

Reference	PSC	d1	L	D	2x	lbs
18.306.040.06	40	0.236	1.969	0.984	15106	0.770
18.306.040.08	40	0.315	1.969	1.102	15108	0.815
18.306.040.10	40	0.394	1.969	1.378	15110	0.970
18.306.040.12	40	0.472	2.165	1.654	15212	1.255
18.306.040.16	40	0.630	2.165	1.890	15314	1.435
18.306.050.06	50	0.236	2.165	0.984	15106	1.215
18.306.050.08	50	0.315	2.165	1.102	15108	1.280
18.306.050.10	50	0.394	2.559	1.378	15110	1.610
18.306.050.12	50	0.472	2.559	1.654	15212	1.920
18.306.050.14	50	0.551	2.559	1.654	15212	1.875
18.306.050.16	50	0.630	2.559	1.890	15314	2.160
18.306.050.18	50	0.709	2.559	1.890	15314	2.095
18.306.050.20	50	0.787	2.559	2.047	15216	2.250
18.306.050.25	50	0.984	3.150	2.559	4 x 15218	3.570
18.306.063.06	63	0.236	3.150	0.984	15106	2.030
18.306.063.08	63	0.315	3.150	1.102	15108	2.120
18.306.063.10	63	0.394	3.150	1.378	15110	2.425
18.306.063.12	63	0.472	3.150	1.654	15212	2.820
18.306.063.14	63	0.551	3.150	1.654	15212	2.780
18.306.063.16	63	0.630	3.150	1.890	15314	3.150
18.306.063.18	63	0.709	3.150	1.890	15314	3.090
18.306.063.20	63	0.787	3.150	2.047	15216	3.330
18.306.063.25	63	0.984	3.543	2.559	4 x 15218	4.585
18.306.063.32	63	1.260	3.543	2.835	4 x 15220	4.170
18.306.063.40	63	1.575	3.740	3.150	4 x 15220	3.705
18.306.080.06	80	0.236	3.150	0.984	15106	4.190
18.306.080.08	80	0.315	3.150	1.102	15108	4.280
18.306.080.10	80	0.394	3.150	1.378	15110	4.540
18.306.080.12	80	0.472	3.150	1.654	15212	4.875
18.306.080.14	80	0.551	3.150	1.654	15212	4.830
18.306.080.16	80	0.630	3.150	1.890	15314	5.140
18.306.080.20	80	0.787	3.150	2.047	15216	5.290
18.306.080.25	80	0.984	3.543	2.559	4 x 15218	6.635
18.306.080.32	80	1.260	3.543	2.835	4 x 15220	7.030
18.306.080.40	80	1.575	4.331	3.150	4 x 15220	8.775
18.306.080.50	80	1.969	4.724	3.937	4 x 15024	8.290
18.306.100.12	100	0.472	3.937	1.654	15212	8.270
18.306.100.16	100	0.630	3.937	1.890	15314	8.665
18.306.100.20	100	0.787	3.937	2.047	15216	8.865
18.306.100.25	100	0.984	3.937	2.559	4 x 15218	10.030
18.306.100.32	100	1.260	3.937	2.835	4 x 15220	10.470
18.306.100.40	100	1.575	4.724	3.150	4 x 15220	12.345
18.306.100.50	100	1.969	5.118	3.937	4 x 15024	16.535





Characteristics:
 Mill adaptors.
 PSC ISO 26623-1
 For frontal end mill support
 screwed shanks.

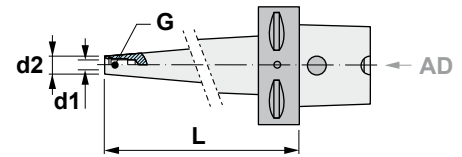

18.315

Reference	PSC	L	d1	d2	
18.315.040.08	40	2.756	M8	0.512	0.685
18.315.040.10	40	3.150	M10	0.709	0.860
18.315.040.12	40	3.150	M12	0.827	0.950
18.315.050.08	50	2.756	M8	0.512	1.080
18.315.050.10	50	3.150	M10	0.709	1.255
18.315.050.12	50	3.150	M12	0.827	1.345
18.315.050.16	50	3.150	M16	1.142	1.655
18.315.063.08	63	2.756	M8	0.512	1.700
18.315.063.10	63	3.543	M10	0.709	1.940
18.315.063.12	63	3.937	M12	0.827	2.160
18.315.063.16	63	3.937	M16	1.142	2.580
18.315.080.12	80	3.937	M12	0.827	4.300
18.315.080.16	80	3.937	M16	1.142	4.650
18.315.100.12	100	4.724	M12	0.827	7.915
18.315.100.16	100	4.724	M16	1.142	7.850







Characteristics:
 Strong hold collet chuck for cylindrical collets.
 PSC ISO 26623-1

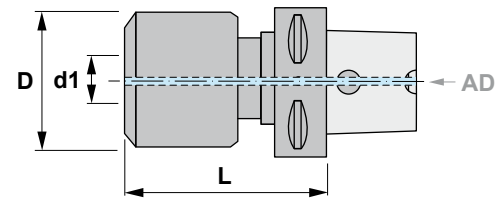
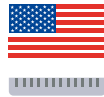

18.400

Reference	PSC	L	d1	D	lbs
18.400.063.0075	63	3.661	0.750	2.125	3.725
18.400.080.0075	80	3.503	0.750	2.834	5.490
18.400.080.0125	80	3.976	1.250	2.834	6.925
18.400.100.0125	100	4.724	1.250	2.834	11.375



Complements (Collets type C)

Reference	d	D	L
C2006	0.236	0.787	2.165
C2008	0.315	0.787	2.165
C2010	0.394	0.787	2.165
C2012	0.472	0.787	2.165
C2016	0.630	0.787	2.165
C3206	0.236	1.260	2.559
C3208	0.315	1.260	2.559
C3210	0.394	1.260	2.559
C3212	0.472	1.260	2.559
C3216	0.630	1.260	2.559
C3220	0.787	1.260	2.559
C3225	0.984	1.260	2.559

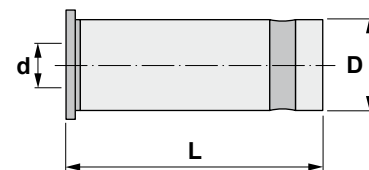



Characteristics:
Strong hold collet chuck for cylindrical collets.
PSC ISO 26623-1

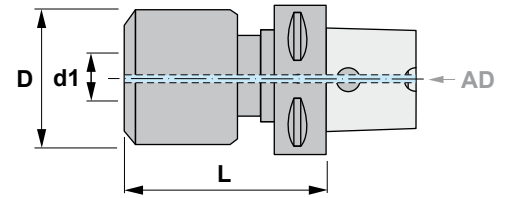

18.400

Reference	PSC	L	d1	D	lbs
18.400.063.20	63	3.661	0.787	2.126	3.725
18.400.080.20	80	3.504	0.787	2.835	5.490
18.400.080.32	80	3.976	1.260	2.835	6.925
18.400.100.32	100	4.724	1.260	2.835	11.375

Complements (Collets type C)

Reference	d	D	L
C2006	0.236	0.787	2.165
C2008	0.315	0.787	2.165
C2010	0.394	0.787	2.165
C2012	0.472	0.787	2.165
C2016	0.630	0.787	2.165
C3206	0.236	1.260	2.559
C3208	0.315	1.260	2.559
C3210	0.394	1.260	2.559
C3212	0.472	1.260	2.559
C3216	0.630	1.260	2.559
C3220	0.787	1.260	2.559
C3225	0.984	1.260	2.559

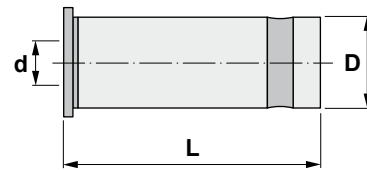



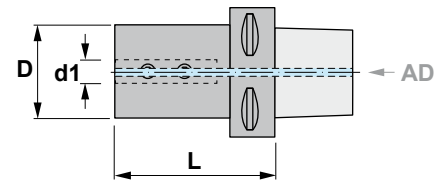

Characteristics:
Boring bar holders.
PSC ISO 26623-1



18.406



Reference	PSC	L	d1	D		
18.406.040.0025	40	1.970	0.250	1.420	14302	1.150
18.406.040.0037	40	1.970	0.375	1.420	14303	1.280
18.406.040.0050	40	1.970	0.500	1.420	14303	1.310
18.406.040.0062	40	1.970	0.625	1.420	14306	1.380
18.406.040.0075	40	2.360	0.750	1.420	14306	1.600
18.406.040.0100	40	3.583	1.000	2.284	14306	1.810
18.406.050.0037	50	2.360	0.375	1.420	14303	1.720
18.406.050.0050	50	2.360	0.500	1.420	14303	1.740
18.406.050.0062	50	2.360	0.625	1.420	14306	1.780
18.406.050.0075	50	2.360	0.750	1.420	14306	1.810
18.406.050.0100	50	2.760	1.000	2.130	14306	2.205
18.406.050.0150	50	4.528	1.500	2.870	14306	3.130
18.406.063.0037	63	2.560	0.375	1.420	14303	2.515
18.406.063.0050	63	2.560	0.500	1.420	14303	2.600
18.406.063.0062	63	2.560	0.625	1.420	14306	2.625
18.406.063.0075	63	2.660	0.750	1.420	14306	2.875
18.406.063.0100	63	2.950	1.000	2.130	14306	3.130
18.406.063.0150	63	4.130	1.500	2.870	14306	7.090
18.406.080.0062	80	3.350	0.625	1.420	14306	5.030
18.406.080.0075	80	3.350	0.750	1.420	14306	5.315
18.406.080.0100	80	3.350	1.000	2.130	14306	5.490
18.406.080.0150	80	3.350	1.500	2.870	14306	9.800

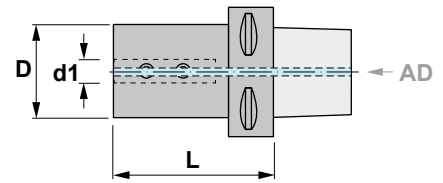

Characteristics:
Boring bar holders.
PSC ISO 26623-1



18.406

Reference	PSC	L	d1	D		
18.406.040.08	40	1.969	0.315	1.732	14206	1.300
18.406.040.10	40	1.969	0.394	1.732	14208	1.280
18.406.040.12	40	1.969	0.472	1.732	14208	1.255
18.406.040.16	40	1.969	0.630	1.732	14210	1.215
18.406.040.20	40	1.969	0.787	1.732	14210	1.125
18.406.040.25	40	2.362	0.984	1.969	14210	1.455
18.406.050.08	50	2.047	0.315	1.732	14206	1.740
18.406.050.10	50	2.047	0.394	1.732	14208	1.720
18.406.050.12	50	2.047	0.472	1.732	14208	1.700
18.406.050.16	50	2.047	0.630	1.732	14210	1.610
18.406.050.20	50	2.047	0.787	1.969	14210	1.810
18.406.050.25	50	2.362	0.984	2.165	14210	2.205
18.406.063.08	63	2.362	0.315	1.732	14206	2.515
18.406.063.10	63	2.362	0.394	1.732	14208	2.495
18.406.063.12	63	2.362	0.472	1.732	14208	2.470
18.406.063.16	63	2.362	0.630	1.732	14210	2.405
18.406.063.20	63	2.362	0.787	1.969	14210	2.625
18.406.063.25	63	2.835	0.984	2.165	14210	3.130
18.406.063.32	63	2.953	1.260	2.165	14210	2.910
18.406.063.40	63	3.346	1.575	2.559	14210	7.190
18.406.080.16	80	3.346	0.630	1.732	14210	5.030
18.406.080.20	80	3.346	0.787	1.969	14210	5.315
18.406.080.25	80	3.346	0.984	2.165	14210	5.490
18.406.080.32	80	3.346	1.260	2.835	14310	6.790
18.406.080.40	80	3.740	1.575	2.559	14310	10.695
18.406.080.50	80	3.937	1.969	2.953	14310	10.320
18.406.100.16	100	3.937	0.630	1.732	14210	7.560
18.406.100.20	100	3.937	0.787	1.969	14210	8.050
18.406.100.25	100	3.937	0.984	2.165	14210	8.600
18.406.100.32	100	3.937	1.260	2.165	14310	10.140
18.406.100.40	100	4.331	1.575	2.559	14310	11.465
18.406.100.50	100	4.724	1.969	2.953	14310	12.300







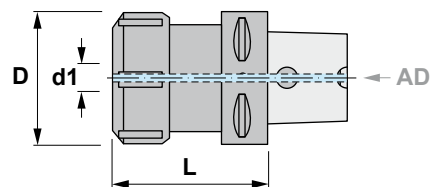

Characteristics:
Collet chucks for DIN 6499 (ER) collets.
PSC ISO 26623-1
For tools with cylindrical shank DIN 1835-B.



*** SUPPLIED WITHOUT WRENCH**

18.453

Reference	PSC		L	d1	D			
18.453.040.16	40	ER16	2.362	0.020-0.394	1.102	45316	50216	0.925
18.453.040.20	40	ER20	2.362	0.039-0.512	1.339	45320	50220	1.080
18.453.040.25	40	ER25	2.362	0.039-0.630	1.654	45325	50225	1.390
18.453.040.32	40	ER32	2.362	0.079-0.787	1.969	45332	50232	1.875
18.453.050.16	50	ER16	2.362	0.020-0.394	1.102	45316	50216	1.325
18.453.050.16/100	50	ER16	3.937	0.020-0.394	1.102	45316	50216	1.740
18.453.050.20	50	ER20	2.362	0.039-0.512	1.339	45320	50220	1.480
18.453.050.20/100	50	ER20	3.937	0.039-0.512	1.339	45320	50220	1.985
18.453.050.25	50	ER25	2.362	0.039-0.630	1.654	45325	50225	1.785
18.453.050.25/100	50	ER25	3.937	0.039-0.630	1.654	45325	50225	2.535
18.453.050.32	50	ER32	2.362	0.079-0.787	1.969	45332	50232	2.250
18.453.050.32/100	50	ER32	3.937	0.079-0.787	1.969	45332	50232	3.350
18.453.050.40	50	ER40	2.559	0.118-1.181	2.480	45340	50240	3.110
18.453.050.40/100	50	ER40	3.937	0.118-1.181	2.480	45340	50240	4.300
18.453.063.16	63	ER16	2.362	0.020-0.394	1.102	45316	50216	1.920
18.453.063.16/100	63	ER16	3.937	0.020-0.394	1.102	45316	50216	2.340
18.453.063.20	63	ER20	2.362	0.039-0.512	1.339	45320	50220	2.075
18.453.063.20/100	63	ER20	3.937	0.039-0.512	1.339	45320	50220	2.580
18.453.063.25	63	ER25	2.362	0.039-0.630	1.654	45325	50225	2.360
18.453.063.25/100	63	ER25	3.937	0.039-0.630	1.654	45325	50225	3.110
18.453.063.32	63	ER32	2.362	0.079-0.787	1.969	45332	50232	2.820
18.453.063.32/100	63	ER32	3.937	0.079-0.787	1.969	45332	50232	3.990
18.453.063.40	63	ER40	2.756	0.118-1.181	2.480	45340	50240	3.900
18.453.063.40/120	63	ER40	4.724	0.118-1.181	2.480	45340	50240	6.040
18.453.080.32	80	ER32	2.756	0.079-0.787	1.969	45332	50232	5.095
18.453.080.32/160	80	ER32	6.299	0.079-0.787	1.969	45332	50232	7.540
18.453.080.40	80	ER40	2.756	0.118-1.181	2.480	45340	50240	5.865
18.453.080.40/160	80	ER40	6.299	0.118-1.181	2.480	45340	50240	9.590
18.453.100.32	100	ER32	3.937	0.079-0.787	1.969	45332	50232	8.730
18.453.100.32/160	100	ER32	6.299	0.079-0.787	1.969	45332	50232	10.540
18.453.100.40	100	ER40	3.937	0.118-1.181	2.480	45340	50240	9.765
18.453.100.40/160	100	ER40	6.299	0.118-1.181	2.480	45340	50240	12.545
18.453.100.50	100	ER50	3.937	0.236-1.339	3.071	45350	50250	12.040
18.453.100.50/160	100	ER50	6.299	0.236-1.339	3.071	45350	50250	15.850





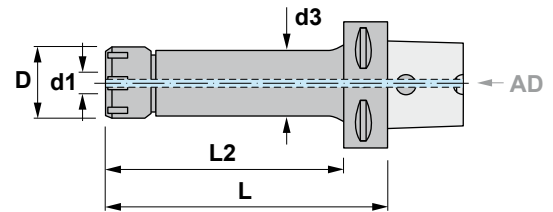

Characteristics:
 Long collet chuck for
 DIN 6499 (ER) collets.
 PSC ISO 26623-1
 For tools with cylindrical shank.
 With "mini" collet nut.



*** SUPPLIED WITHOUT WRENCH**

18.455

Reference	PSC		L	d1	D	L2	d3				
18.455.063.16	63	ER16	2.362	0.020-0.394	0.866	-	-	45516	50916	19210	1.895
18.455.063.16/100	63	ER16	3.937	0.020-0.394	0.866	3.071	0.866	45516	50916	19210	2.095
18.455.063.20	63	ER20	2.362	0.039-0.512	1.102	-	-	45520	50920	19212	2.120
18.455.063.20/100	63	ER20	3.937	0.039-0.512	1.102	3.071	1.181	45520	50920	19212	2.470

ERXX

Reference	Accessories
ERXX	Collets with double slot DIN 6499 - Form B (ER)



ERCXX

Reference	Accessories
ERCXX	Sealed collets DIN 6499 (ER)



ERTXX

Reference	Accessories
ERTXX	Collets DIN 6499 - Form Mexin (ER)





Characteristics:
Blank adaptors.
PSC ISO 26623-1

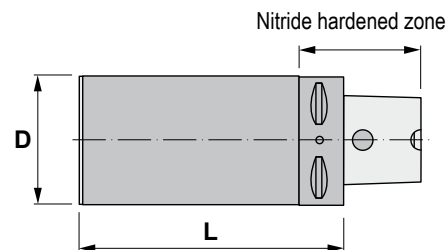

18.470

Reference	PSC	D	L	
18.470.032.032/090	32	1.260	3.543	1.300
18.470.032.040/110	32	1.575	4.331	2.315
18.470.032.050/125	32	1.969	4.921	3.990
18.470.032.060/090	32	2.362	3.543	3.925
18.470.032.070/060	32	2.756	2.362	3.240
18.470.032.090/070	32	3.543	2.756	6.305
18.470.040.040/095	40	1.575	3.740	2.185
18.470.040.040/120	40	1.575	4.724	2.735
18.470.040.060/165	40	2.362	6.496	7.630
18.470.040.080/075	40	3.150	2.953	5.335
18.470.040.080/120	40	3.150	4.724	9.240
18.470.040.100/085	40	3.937	3.346	9.390
18.470.050.050/125	50	1.969	4.921	4.520
18.470.050.050/150	50	1.969	5.906	5.360
18.470.050.063/180	50	2.480	7.087	9.570
18.470.050.075/175	50	2.953	6.890	12.790
18.470.050.090/080	50	3.543	3.150	7.540
18.470.050.095/150	50	3.740	5.906	16.890
18.470.050.110/090	50	4.331	3.543	12.460
18.470.063.063/180	63	2.480	7.087	10.210
18.470.063.075/195	63	2.953	7.677	14.795
18.470.063.110/085	63	4.331	3.346	11.930
18.470.063.110/120	63	4.331	4.724	17.680
18.470.063.120/180	63	4.724	7.087	32.475
18.470.063.130/095	63	5.118	3.740	32.500
18.470.080.080/200	80	3.150	7.874	18.585
18.470.080.100/200	80	3.937	7.874	26.900
18.470.080.120/160	80	4.724	6.299	29.235
18.470.080.130/090	80	5.118	3.543	17.570
18.470.080.150/200	80	5.906	7.874	55.780
18.470.080.160/120	80	6.299	4.724	35.120
18.470.100.100/100	100	3.937	3.937	16.050
18.470.100.100/200	100	3.937	7.874	29.650
18.470.100.150/100	100	5.906	3.937	27.600
18.470.100.150/200	100	5.906	7.874	58.180
18.470.100.160/150	100	6.299	5.906	47.865
18.470.100.200/100	100	7.874	3.937	43.760





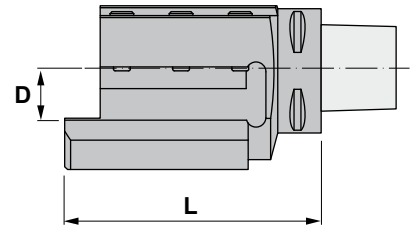
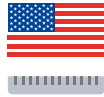

Characteristics:
 Adaptor with axial mounting.
 PSC ISO 26623-1
 Adaptor for square turning toolholder
 left / right hand.



18.500

Reference	PSC	D	L	lbs
18.500.050.0075R/L	50	0.750	3.858	4.520
18.500.063.0075R/L	63	0.750	3.937	5.645
18.500.063.0100R/L	63	1.000	5.118	8.025
18.500.080.0125R/L	80	1.250	5.512	8.795



Reference	3x 	
18.500.050.0075R/L	17207	29708
18.500.063.0075R/L	17207	29708
18.500.063.0100R/L	17207	29708
18.500.080.0125R/L	17207	29710



Characteristics:
 Adaptor with axial mounting.
 PSC ISO 26623-1
 Adaptor for square turning toolholder
 left / right hand.

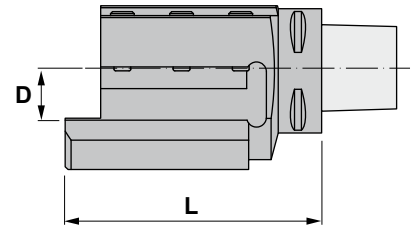

18.500

Reference	PSC	D	L	
18.500.050.20R/L	50	0.787	3.858	4.520
18.500.063.20R/L	63	0.787	3.937	5.645
18.500.063.25R/L	63	0.984	5.118	8.025
18.500.063.32R/L	63	1.260	5.275	8.795
18.500.080.32R/L	80	1.260	5.512	11.885
18.500.100.32R/L	100	1.260	5.906	22.265

Reference	3x 	
18.500.050.20R/L	17010	29708
18.500.063.20R/L	17110	29708
18.500.063.25R/L	17012	29708
18.500.063.32R/L	17012	29708
18.500.080.32R/L	17012	29710
18.500.100.32R/L	17012	29710



Characteristics:
 Adaptor with angular mounting.
 PSC ISO 26623-1
 Adaptor for square turning toolholder
 left / right hand.

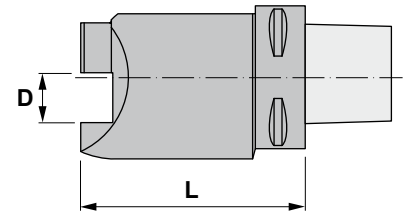
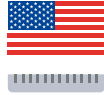

18.510

Reference	PSC	D	L	 lbs
18.510.050.0075R/L	50	0.750	3.819	3.900
18.510.063.0075R/L	63	0.750	3.898	4.810
18.510.080.0125R/L	80	1.250	5.315	14.725



Reference		
18.510.050.0075R/L	17207	29708
18.510.063.0075R/L	17207	29708
18.510.080.0125R/L	17212	29710



Characteristics:
 Adaptor with angular mounting.
 PSC ISO 26623-1
 Adaptor for square turning toolholder
 left / right hand.

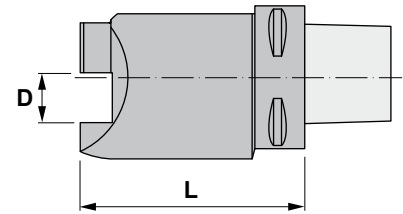

18.510

Reference	PSC	D	L	
18.510.050.20R/L	50	0.787	3.819	3.900
18.510.063.20R/L	63	0.787	3.898	4.810
18.510.063.25R/L	63	0.984	5.118	9.765
18.510.080.32R/L	80	1.260	5.315	14.725
18.510.100.32R/L	100	1.260	5.709	22.115

Reference		
18.510.050.20R/L	17110	29708
18.510.063.20R/L	17110	29708
18.510.063.25R/L	17012	29708
18.510.080.32R/L	17012	29710
18.510.100.32R/L	17012	29710





Characteristics:
 Mini-turret with axial mounting.
 PSC ISO 26623-1
 Multipurpose mini-turret for square toolholders.

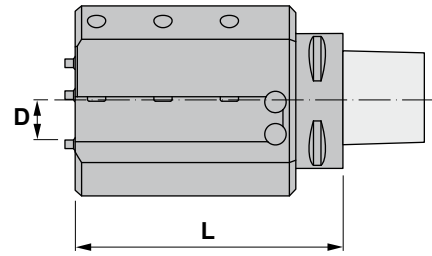
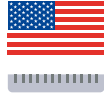

18.520

Reference	PSC	D	L	lbs
18.520.050.0075R/L	50	0.750	4.842	8.315
18.520.063.0075R/L	63	0.750	4.921	9.370
18.520.080.0125R/L	80	1.250	5.906	17.150



Reference		
18.520.050.0075R/L	17207	29708
18.520.063.0075R/L	17207	29708
18.520.080.0125R/L	17212	29710



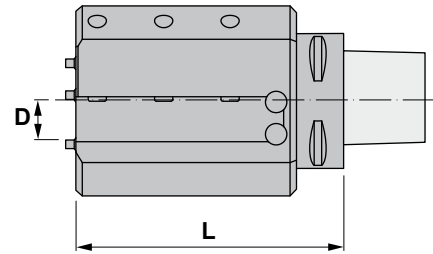

Characteristics:
 Mini-turret with axial mounting.
 PSC ISO 26623-1
 Multipurpose mini-turret for square
 toolholders.



18.520

Reference	PSC	D	L	 lbs
18.520.050.20R/L	50	0.787	4.842	8.315
18.520.063.20R/L	63	0.787	4.921	9.370
18.520.063.25R/L	63	0.984	5.118	11.330
18.520.080.32R/L	80	1.260	5.906	17.150
18.520.100.32R/L	100	1.260	6.299	25.130

Reference		
18.520.050.20R/L	17012	29708
18.520.063.20R/L	17012	29708
18.520.063.25R/L	17012	29708
18.520.080.32R/L	17012	29710
18.520.100.32R/L	17012	29710



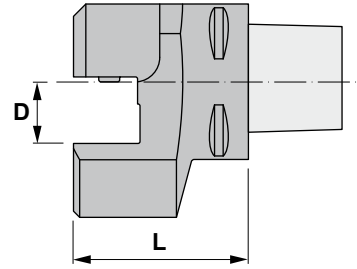
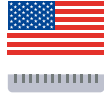

Characteristics:
 Adaptor with radial mounting.
 PSC ISO 26623-1
 Multipurpose adaptor for square
 toolholders.



18.530

Reference	PSC	D	L	 lbs
18.530.050.0075	50	0.750	2.244	3.220
18.530.063.0075	63	0.750	2.323	3.950
18.530.063.0100	63	1.000	2.795	6.305
18.530.080.0125	80	1.250	3.337	10.470



Reference		
18.530.050.0075	17307	29708
18.530.063.0075	17307	29708
18.530.063.0100	17207	29708
18.530.080.0125	17207	29710

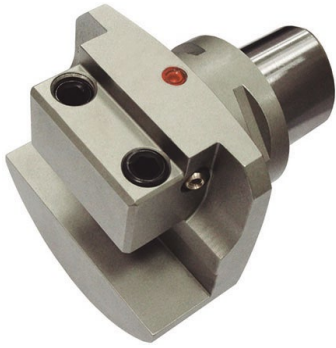

Characteristics:
Adaptor with radial mounting.
PSC ISO 26623-1
Multipurpose adaptor for square
toolholders.

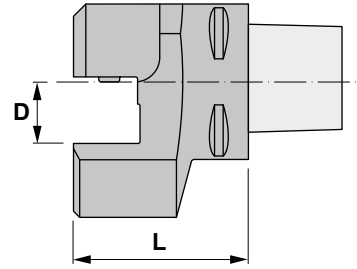

18.530

Reference	PSC	D	L	 lbs
18.530.050.20	50	0.787	2.283	3.220
18.530.063.20	63	0.787	2.362	3.950
18.530.063.25	63	0.984	2.795	6.305
18.530.063.32	63	1.260	2.795	7.275
18.530.080.32	80	1.260	3.346	10.470
18.530.100.32	100	1.260	3.543	14.265

Reference		
18.530.050.20	17112	29708
18.530.063.20	17112	29708
18.530.063.25	17012	29708
18.530.063.32	17012	29708
18.530.080.32	17012	29710
18.530.100.32	17012	29710





Characteristics:
Adaptor with axial mounting for blades.
PSC ISO 26623-1

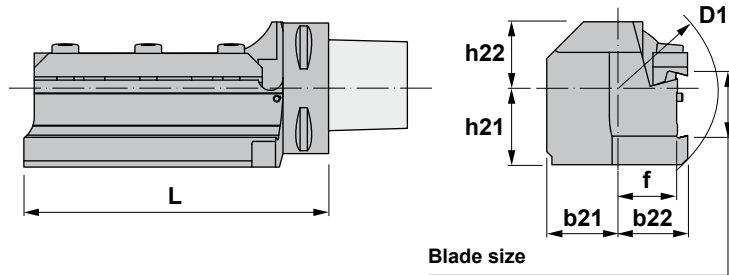

18.540

Reference	PSC	Blade size	D1	b21	b22	f	h21	h22	L	
18.540.050.26R/L	50	26	3.465	0.984	1.260	1.063	1.181	1.024	3.740	3.310
18.540.063.32R/L	63	32	4.173	1.260	1.555	1.260	1.496	1.260	5.787	7.275
18.540.080.32R/L	80	32	4.961	1.594	1.890	1.594	1.594	1.594	6.102	11.465
18.540.100.32R/L	100	32	5.709	1.969	2.283	1.988	1.988	1.969	6.299	20.370
18.540.100.52R/L	100	52/53	6.890	1.969	2.283	1.988	2.559	1.969	7.874	27.360

Reference		
18.540.050.26R/L	80526	11008
18.540.063.32R/L	80632	11108
18.540.080.32R/L	80632	11108
18.540.100.32R/L	80632	11108
18.540.100.52R/L	81052	11108



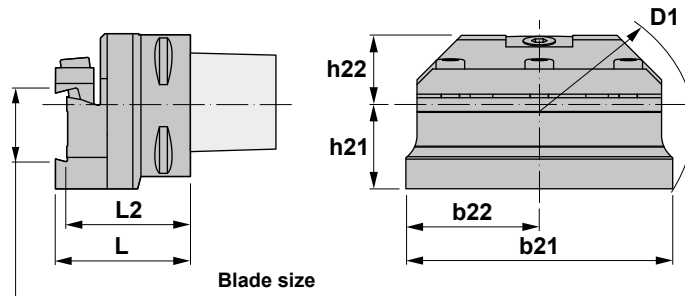

Characteristics:
Adaptor with radial mounting for blades.
PSC ISO 26623-1



18.550

Reference	PSC	Blade size	D1	b21	b22	h21	h22	L	L2	
18.550.050.26	50	26	3.937	3.150	1.575	1.181	0.992	2.283	2.087	2.865
18.550.063.32	63	32	5.551	4.724	2.362	1.457	1.260	2.480	2.186	5.070
18.550.080.32	80	32	5.709	4.724	2.362	1.594	1.575	2.795	2.500	7.720
18.550.100.32	100	32	5.709	4.724	2.362	1.988	1.969	2.953	2.657	12.280
18.550.100.52	100	52/53	7.677	6.299	3.150	2.559	1.969	2.953	2.657	14.200

Reference		
18.550.050.26	80526	11008
18.550.063.32	81632	11108
18.550.080.32	81632	11108
18.550.100.32	81632	11108
18.550.100.52	81052	11108



Characteristics:
 Quick change tapping head with axial compensation.
 PSC ISO 26623-1
 With Bilz system tap chucks bushings.
 Compensation in compression (C) and tension (T).

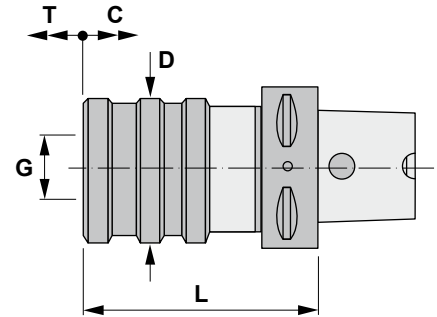

18.620

Reference	PSC	N ^o .	G Ø	d1	L	D	C	T			
18.620.040.12	40	1	19	M3-M12	2.559	1.496	0.354	0.354	710XX	750XX	1.125
18.620.050.12	50	1	19	M3-M12	2.559	1.496	0.354	0.354	710XX	750XX	1.520
18.620.063.12	63	1	19	M3-M12	2.756	1.496	0.354	0.354	710XX	750XX	2.140
18.620.063.20	63	2	31	M8-M20	3.740	2.165	0.591	0.591	720XX	760XX	3.770
18.620.063.33	63	3	48	M14-M33	5.512	3.110	0.945	0.945	730XX	770XX	7.830
18.620.080.12	80	1	19	M3-M12	3.150	1.496	0.354	0.354	710XX	750XX	4.520
18.620.080.20	80	2	31	M8-M20	3.937	2.165	0.591	0.591	720XX	760XX	6.000
18.620.080.33	80	3	48	M14-M33	5.906	3.110	0.945	0.945	730XX	770XX	11.110
18.620.100.12	100	1	19	M3-M12	3.543	1.496	0.354	0.354	710XX	750XX	7.650
18.620.100.20	100	2	31	M8-M20	4.331	2.165	0.591	0.591	720XX	760XX	9.215
18.620.100.33	100	3	48	M14-M33	6.299	3.110	0.945	0.945	730XX	770XX	14.595

710XX..730XX

Reference	Accessories
710XX..730XX	Quick change adapters without overload clutch



750XX..770XX

Reference	Accessories
750XX..770XX	Quick change adapters with overload clutch





Characteristics:
Test arbors.
PSC ISO 26623-1

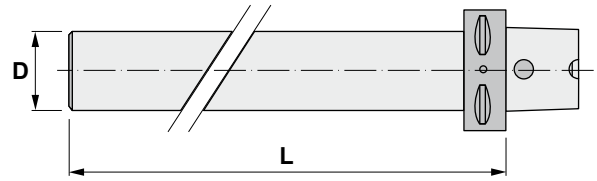

18.999

Reference	PSC	L	D	 lbs
18.999.050	50	10.039	1.260	4.210
18.999.063	63	12.677	1.575	7.190
18.999.080	80	13.028	1.575	10.320





Characteristics:
Adaptor DIN 69871-A
to PSC ISO 26623-1.

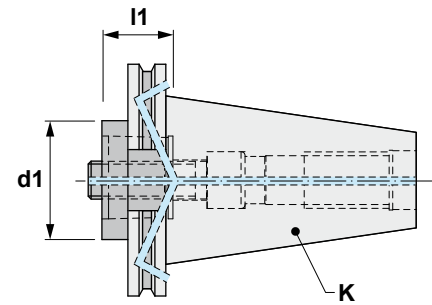

13.218

Reference	K ISO	PSC	d1	l1	
13.218.30.32/030	30	32	1.260	1.181	0.880
13.218.30.32/060	30	32	1.260	2.362	1.210
13.218.40.32/030	40	32	1.260	1.181	1.875
13.218.40.32/060	40	32	1.260	2.362	2.205
13.218.40.40/030	40	40	1.575	1.181	1.875
13.218.40.40/060	40	40	1.575	2.362	2.425
13.218.40.50/030	40	50	1.969	1.181	1.875
13.218.40.50/070	40	50	1.969	2.756	3.090
13.218.40.63/085	40	63	2.480	3.346	4.190
13.218.50.32/030	50	32	1.260	1.181	5.950
13.218.50.32/060	50	32	1.260	2.362	6.615
13.218.50.40/030	50	40	1.575	1.181	1.875
13.218.50.40/060	50	40	1.575	2.362	6.615
13.218.50.50/030	50	50	1.969	1.181	5.840
13.218.50.50/070	50	50	1.969	2.756	7.075
13.218.50.63/030	50	63	2.480	1.181	5.755
13.218.50.63/080	50	63	2.480	3.150	8.270
13.218.50.80/070	50	80	3.150	2.756	8.600
13.218.50.80/120	50	80	3.150	4.724	12.235



Characteristics:
Adaptor HSK DIN 69893-1
to PSC ISO 26623-1.

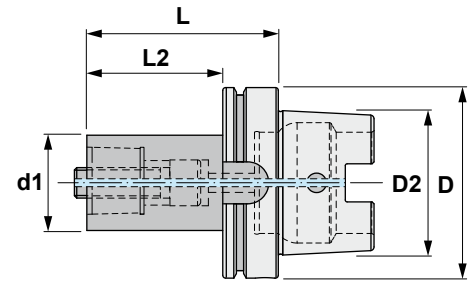

16.218

Reference	HSK	PSC	d1	D	D2	L	L2	
16.218.063.32/075	63	32	1.260	2.480	1.890	2.953	1.929	1.985
16.218.063.40/080	63	40	1.575	2.480	1.890	3.150	2.126	2.425
16.218.063.50/090	63	50	1.969	2.480	1.890	3.543	2.520	3.200
16.218.100.32/080	100	32	1.260	3.937	2.953	3.150	2.008	5.095
16.218.100.40/090	100	40	1.575	3.937	2.953	3.543	2.402	5.620
16.218.100.50/100	100	50	1.969	3.937	2.953	3.937	2.795	6.505
16.218.100.63/110	100	63	2.480	3.937	2.953	4.331	3.189	8.160
16.218.100.80/120	100	80	3.150	3.937	2.953	4.724	3.583	10.800





Characteristics:
Extension
PSC ISO 26623-1.

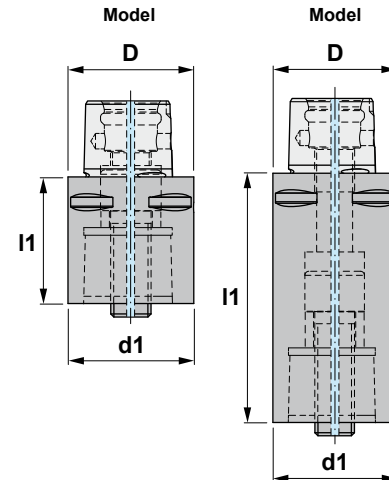

18.218

Reference	Model	Side PSC / Machine	d1	D	l1	
18.218.32.32/035	1	32	1.260	1.260	1.378	0.440
18.218.32.32/060	2	32	1.260	1.260	2.362	0.795
18.218.32.32/080	2	32	1.260	1.260	3.150	1.080
18.218.40.40/040	1	40	1.575	1.575	1.575	0.815
18.218.40.40/060	2	40	1.575	1.575	2.362	1.320
18.218.40.40/080	2	40	1.575	1.575	3.150	1.765
18.218.50.50/050	1	50	1.969	1.969	1.969	1.610
18.218.50.50/080	2	50	1.969	1.969	3.150	2.735
18.218.50.50/100	2	50	1.969	1.969	3.937	3.305
18.218.63.63/060	1	63	2.480	2.480	2.362	2.980
18.218.63.63/100	2	63	2.480	2.480	3.937	5.180
18.218.63.63/140	2	63	2.480	2.480	5.512	7.275
18.218.80.80/065	1	80	3.150	3.150	2.559	5.180
18.218.80.80/100	2	80	3.150	3.150	3.937	8.270
18.218.80.80/125	2	80	3.150	3.150	4.921	10.470



Characteristics:
Reducer
PSC ISO 26623-1.

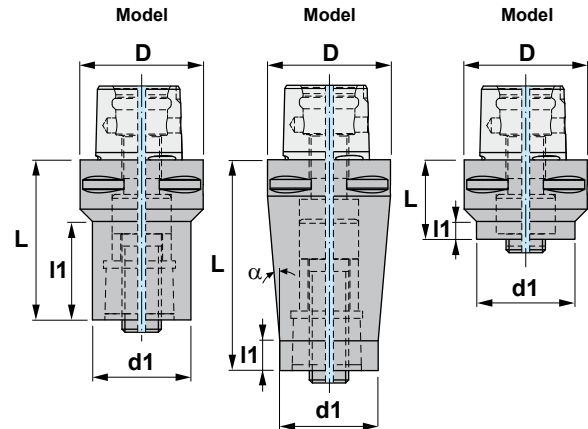

18.218

Reference	Model	Side Machine	Side PSC	D	d1	L	l1	α	
18.218.40.32/055	1	40	32	1.575	1.260	2.165	1.220	-	0.950
18.218.40.32/070	2	40	32	1.575	1.260	2.756	0.472	6.0°	1.235
18.218.50.32/060	1	50	32	1.969	1.260	2.362	1.370	-	1.410
18.218.50.40/065	1	50	40	1.969	1.575	2.559	1.575	-	1.765
18.218.50.40/085	2	50	40	1.969	1.575	3.346	0.472	5.4°	2.490
18.218.50.32/033	3	50	32	1.969	1.260	1.299	0.394	-	1.035
18.218.50.40/040	3	50	40	1.969	1.575	1.575	0.709	-	1.210
18.218.63.32/070	1	63	32	2.480	1.260	2.756	1.535	-	2.140
18.218.63.40/080	1	63	40	2.480	1.575	3.150	2.024	-	2.645
18.218.63.50/080	1	63	50	2.480	1.969	3.150	2.028	-	3.305
18.218.63.50/110	2	63	50	2.480	1.969	4.331	0.472	4.9°	4.960
18.218.63.32/032	3	63	32	2.480	1.260	1.260	0.236	-	1.675
18.218.63.40/040	3	63	40	2.480	1.575	1.575	0.433	-	1.765
18.218.63.50/050	3	63	50	2.480	1.969	1.969	1.043	-	2.205
18.218.80.32/060	1	80	32	3.150	1.260	2.362	1.153	-	4.190
18.218.80.40/070	1	80	40	3.150	1.575	2.756	1.437	-	4.410
18.218.80.50/080	1	80	50	3.150	1.969	3.150	1.941	-	5.070
18.218.80.63/080	1	80	63	3.150	2.480	3.150	2.090	-	5.840
18.218.80.63/120	2	80	63	3.150	2.480	4.724	0.472	6.2°	9.480
18.218.80.50/045	3	80	50	3.150	1.969	1.772	0.394	-	3.970
18.218.80.63/055	3	80	63	3.150	2.480	2.165	0.787	-	4.410



Characteristics:
Adaptor JIS B 6339-BT
to PSC ISO 26623-1.

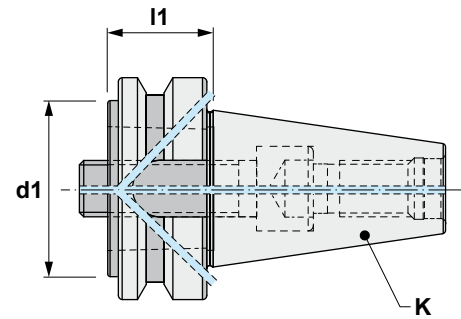

23.218

Reference	K ISO	PSC	d1	l1	
23.218.30.32/030	30	32	1.260	1.181	0.880
23.218.30.32/060	30	32	1.260	2.362	1.320
23.218.40.32/030	40	32	1.260	1.181	2.205
23.218.40.32/060	40	32	1.260	2.362	2.645
23.218.40.40/030	40	40	1.575	1.181	2.095
23.218.40.40/060	40	40	1.575	2.362	2.755
23.218.40.50/030	40	50	1.969	1.181	1.985
23.218.40.50/070	40	50	1.969	2.756	3.305
23.218.40.63/075	40	63	2.480	2.953	4.190
23.218.50.32/040	50	32	1.260	1.575	8.050
23.218.50.32/070	50	32	1.260	2.756	8.490
23.218.50.40/040	50	40	1.575	1.575	8.050
23.218.50.40/070	50	40	1.575	2.756	8.600
23.218.50.50/040	50	50	1.969	1.575	7.830
23.218.50.50/080	50	50	1.969	3.150	9.150
23.218.50.63/040	50	63	2.480	1.575	7.605
23.218.50.63/090	50	63	2.480	3.543	10.250
23.218.50.80/070	50	80	3.150	2.756	9.260
23.218.50.80/120	50	80	3.150	4.724	13.560



Characteristics:
Manual caps.

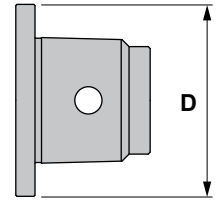

MC

Reference	Manual Cap	
PSC32-MC	1.260	0.175
PSC40-MC	1.575	0.330
PSC50-MC	1.969	0.400
PSC63-MC	2.480	0.925
PSC80-MC	3.150	2.205



Characteristics:
Automatic caps.

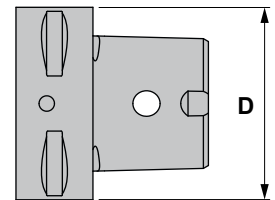

AC

Reference	Automatic Cap	
PSC40-AC	1.575	0.550
PSC50-AC	1.969	0.980
PSC63-AC	2.480	1.545
PSC80-AC	3.150	3.750

