

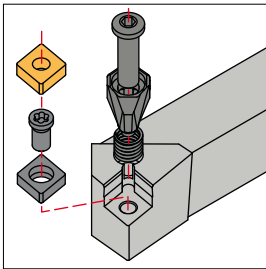

TOOLHOLDERS

Clamping systems	A54
Code system (ISO)	A55
Applications index	A56-59
Dimple lock toolholders	A60-71
Wedge clamp toolholders	A72-75
Double lock toolholders	A76-99
Top clamp toolholders	A100-109
Center screw toolholders	A110-133
Cutting data	A134-135



(D) Dimple lock

The "D" clamping system avoids insert movement during high feed or heavily interrupted machining, due to its accurate indexing that holds the insert securely clamped.

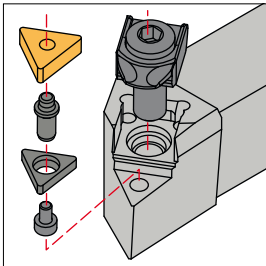

(W) Wedge clamp

Negative inserts require good clamping force for heavy duty work, for this purpose we have designed our "W" system, one of the strongest and safest available.

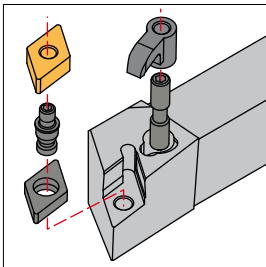

(M) Double lock

The double lock system offers good rigidity in negative inserts clamping. It is the first choice for center hole negative ceramic and cermet inserts.

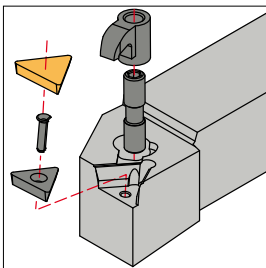

(C) Top clamp

The classic positive insert clamping system is designed to hold flat positive inserts, both with additional or sintered chipbreaker.

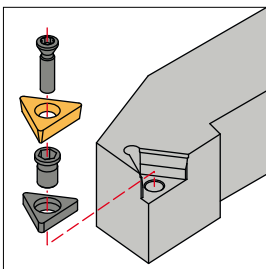
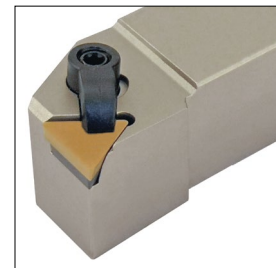

(S) Center screw

Since the advent of the TORX screw it has been possible to hold with complete safety positive inserts with center hole. Our range covers all the screw fixing permutations.

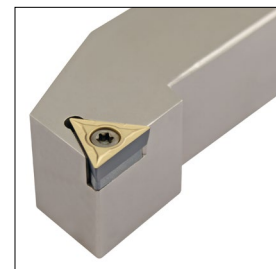

Code system (ISO)



1 Clamping method of insert

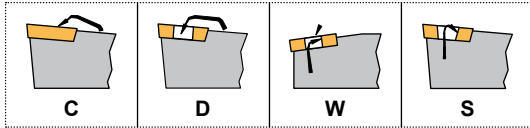

2 Insert shape

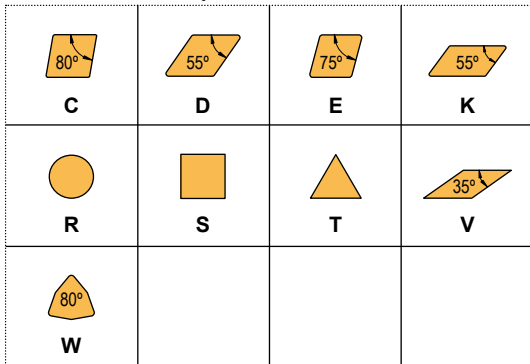

4 Clearance angle of insert

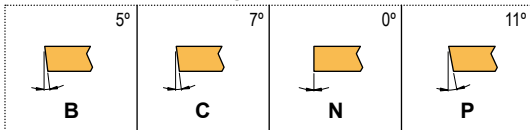

5 Hand

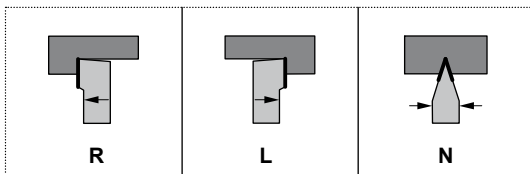

6 Shank height, inch.

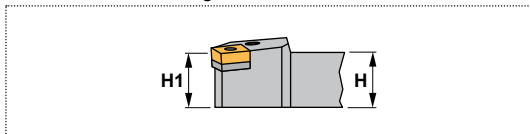

7 Shank width, inch.

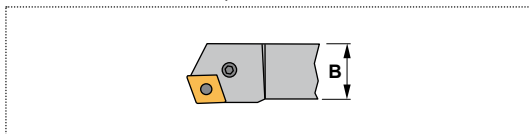

3 Holder style

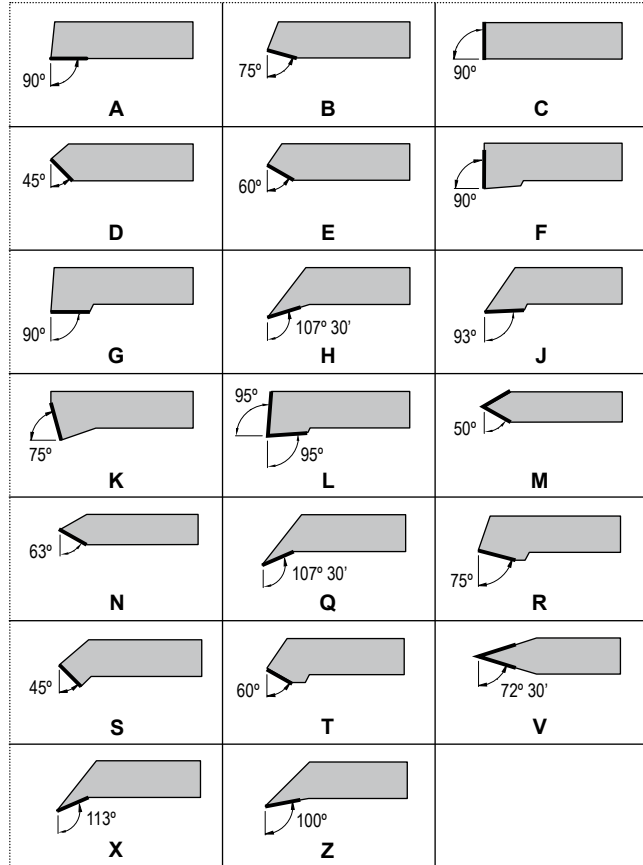

8 Cutting edge length, inch.

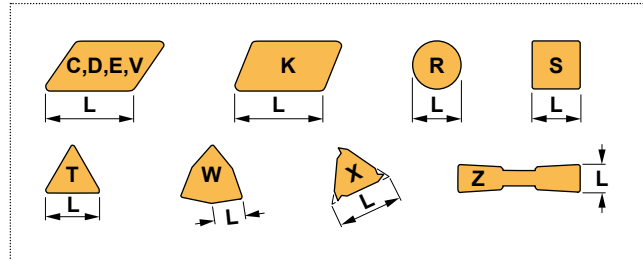



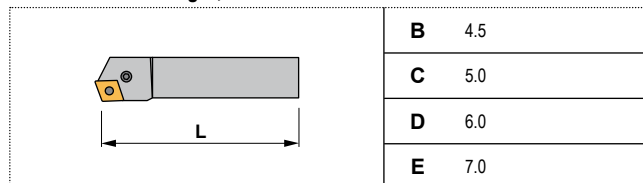





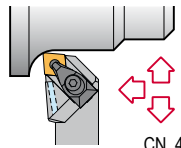

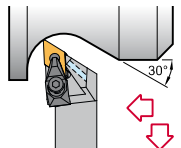

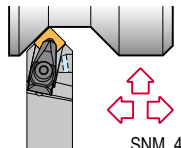
9 Tool length, inch.

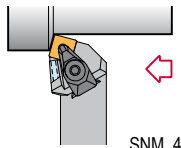

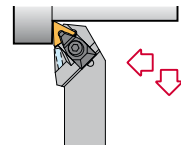
NEGATIVE TOOLHOLDERS

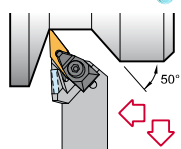
■ Dimple lock toolholders (with internal coolant)

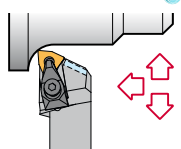
<p>DCLN 95°-AN </p>  <p>CN..43.. CN..54.. CN..64..</p> <p>Page A60</p>	<p>DDJN 93°-AN </p>  <p>30°</p> <p>DN..43..</p> <p>Page A61</p>	<p>DSDN 45°-AN </p>  <p>SNM..43.. SNM..54.. SNM..64..</p> <p>Page A62</p>	<p>DSRN 75°-AN </p>  <p>SNM..43.. SNM..54.. SNM..64..</p> <p>Page A63</p>	<p>DTJN 93°-AN </p>  <p>TNM..33.. TNM..43..</p> <p>Page A64</p>
<p>DVJN 93°-AN </p>  <p>50°</p> <p>VN..33..</p> <p>Page A65</p>	<p>DWLN 95°-AN </p>  <p>WNUM43..</p> <p>Page A66</p>			

■ Dimple lock toolholders (without internal coolant)

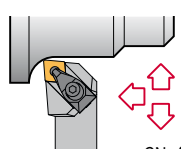
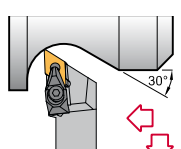
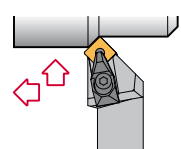
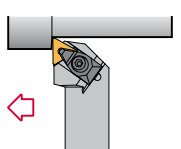
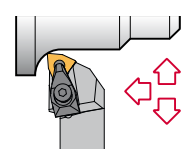
<p>DCLN 95°-N</p>  <p>CN..43.. CN..54.. CN..64..</p> <p>Page A67</p>	<p>DDJN 93°-N</p>  <p>30°</p> <p>DN..43..</p> <p>Page A68</p>	<p>DSSN 45°-N</p>  <p>SNM..43.. SNM..64..</p> <p>Page A69</p>	<p>DTGN 90°-N</p>  <p>TNM..33.. TNM..43..</p> <p>Page A70</p>	<p>DWLN 95°-N</p>  <p>WNUM43..</p> <p>Page A71</p>
---	--	--	---	---

■ Wedge clamp

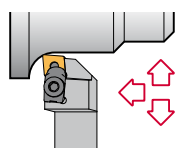
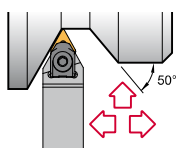
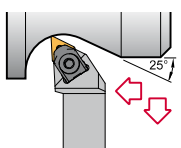
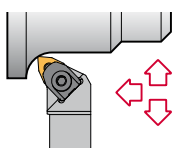
<p>WCLN 95°</p>  <p>CN..43.. CN..64..</p> <p>Page A72</p>	<p>WTENNS 60°</p>  <p>50°</p> <p>TNM..33.. TNM..43..</p> <p>Page A73</p>	<p>WTJNS 93°</p>  <p>25°</p> <p>TNM..33.. TNM..43..</p> <p>Page A74</p>	<p>WWLN 95°</p>  <p>WNM..43..</p> <p>Page A75</p>	
---	--	---	--	--



NEGATIVE TOOLHOLDERS

Double lock toolholders

<p>MCFN 90°</p> <p>CN..43.. CN..54.. CN..64..</p> <p>Page A76</p>	<p>MCGN 90°</p> <p>CN..43.. CN..54.. CN..64..</p> <p>Page A77</p>	<p>MCKN 75°</p> <p>CN..43.. CN..54.. CN..64..</p> <p>Page A78</p>	<p>MCLN 95°</p> <p>CN..43.. CN..54.. CN..64..</p> <p>Page A79</p>	<p>MCMN 50°</p> <p>CN..43.. CN..54.. CN..64..</p> <p>Page A80</p>
<p>MCRN 75°</p> <p>CN..43.. CN..54.. CN..64..</p> <p>Page A81</p>	<p>MDJN 93°</p> <p>DN..33.. DN..43.. DN..54..</p> <p>Page A82</p>	<p>MDPN 62°30'</p> <p>DN..43.. DN..54..</p> <p>Page A83</p>	<p>MDQN 107°30'</p> <p>DN..43..</p> <p>Page A84</p>	<p>MRGN</p> <p>RNMG32.. .. RNMG86..</p> <p>Page A85</p>
<p>MSDN 45°</p> <p>SNM..32.. .. SNM..64..</p> <p>Page A86</p>	<p>MSKN 75°</p> <p>SNM..43.. .. SNM..64..</p> <p>Page A87</p>	<p>MSRN 75°</p> <p>SNM..43.. .. SNM..85..</p> <p>Page A88</p>	<p>MSSN 45°</p> <p>SNM..43.. .. SNM..64..</p> <p>Page A89</p>	<p>MTAN 90°</p> <p>TNM..22.. .. TNM..54..</p> <p>Page A90</p>
<p>MTCN 90°</p> <p>TNM..33.. TNM..43..</p> <p>Page A91</p>	<p>MTENNS 60°</p> <p>TNM..22.. TNM..66..</p> <p>Page A92</p>	<p>MTFN 90°</p> <p>TNM..33.. .. TNM..54..</p> <p>Page A93</p>	<p>MTGN 90°</p> <p>TNM..22.. .. TNM..66..</p> <p>Page A94</p>	<p>MTJNS 93°</p> <p>TNM..33.. .. TNM..66..</p> <p>Page A95</p>
<p>MTRN 75°</p> <p>TNM..33.. .. TNM..54..</p> <p>Page A96</p>	<p>MVJN 93°</p> <p>VN..33.. VN..43..</p> <p>Page A97</p>	<p>MVVN 72°30'</p> <p>VN..33.. VN..43..</p> <p>Page A98</p>	<p>MWLN 95°</p> <p>WNM..33.. WNM..43..</p> <p>Page A99</p>	

POSITIVE TOOLHOLDERS

Top clamp toolholders

<p>CKJN 93°</p> <p>Page A100 KNUX1604..</p>	<p>CSBP 75°</p> <p>Page A101 SP..32.. SP..42..</p>	<p>CSDP 45°</p> <p>Page A102 SP..32.. SP..42..</p>	<p>CTAP 90°</p> <p>Page A103 TP..22.. TP..32..</p>	<p>CTCO 90°</p> <p>Page A104 TP..32.. TP..43..</p>
<p>CTCP 90°</p> <p>Page A105 TP..32.. TP..43..</p>	<p>CTEP 60°</p> <p>Page A106 TP..22.. TP..32..</p>	<p>CTFP 90°</p> <p>Page A107 TP..32..</p>	<p>CTGP 90°</p> <p>Page A108 TP..22.. TP..32..</p>	<p>CTRP 75°</p> <p>Page A109 TP..22.. TP..32..</p>

Center screw toolholders

<p>SAGD 90°</p> <p>Page A110 ADMW1503..</p>	<p>SCAC 90°</p> <p>Page A111 CC..21.5.. CC..32.5..</p>	<p>SCLC 95°</p> <p>Page A112-113 CC..21.5.. CC..32.5.. CC..43..</p>	<p>SDAC 90°</p> <p>Page A114 DC..21.5.. DC..32.5..</p>	<p>SDJC 93°</p> <p>Page A115-116 DC..21.5.. DC..32.5..</p>
<p>SDNC 62° 30'</p> <p>Page A117 DC..21.5.. DC..32.5..</p>	<p>SDPC 62° 30'</p> <p>Page A118 DC..21.5.. DC..32.5..</p>	<p>SRDC</p> <p>Page A119 RC..0803M0 RC..1204M0</p>	<p>SRGC</p> <p>Page A120 RC..10T3M0 RC..1204M0</p>	<p>SRSC</p> <p>Page A121 RC..10T3M0 RC..1204M0</p>
<p>SSDC 45°</p> <p>Page A122 SC..32.5.. SC..43..</p>	<p>STAC 90°</p> <p>Page A123 TC..21.5.. TC..32.5..</p>	<p>STDC 45°</p> <p>Page A124 TC..21.5.. TC..32.5..</p>	<p>STFC 90°</p> <p>TC..21.5.. TC..32.5.. Page A125</p>	<p>STGC 90°</p> <p>Page A126 TC..21.5.. TC..32.5..</p>



POSITIVE TOOLHOLDERS

Center screw toolholders

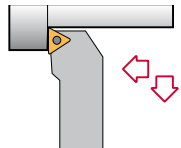
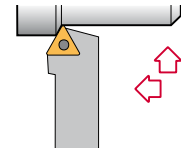
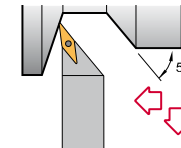
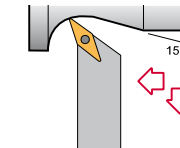
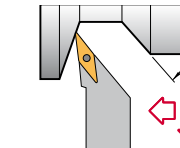
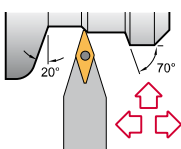
<p>STJC 93°</p>  <p>Page A127 TC..21.5..</p>	<p>STTC 60°</p>  <p>Page A128 TC..32.5..</p>	<p>SVAC 90°</p>  <p>Page A129 VC..22.. VC..33..</p>	<p>SVHC 107°30'</p>  <p>Page A130 VC..33..</p>	<p>SVJC 93°</p>  <p>Page A131-132 VC..22.. VC..33..</p>
<p>SVVC 72°30'</p>  <p>Page A133 VC..33..</p>				

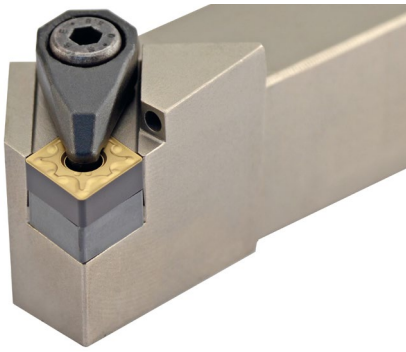

Characteristics:

Multipurpose toolholder equipped with rhombic negative double-sided insert (angle 80°).
For low powered machines and small pieces choose toolholder Ref. SCLC (Page: A112).

Axial -6.5°
Radial -6.5°

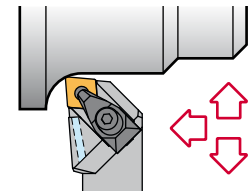
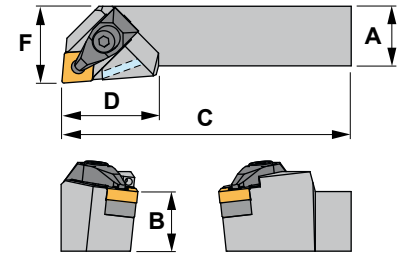

DCLN 95°-AN

Reference	A	B	C	D	F	Insert size	
DCLNR/L124BAN	0.750	0.750	4.50	1.250	1.000	CN..43..	0.880
DCLNR/L164DAN	1.000	1.000	6.00	1.250	1.250	CN..43..	1.540
DCLNR/L204DAN	1.250	1.250	6.00	1.250	1.500	CN..43..	2.755
DCLNR/L205DAN	1.250	1.250	6.00	1.375	1.500	CN..54..	2.755
DCLNR/L245EAN	1.500	1.500	7.00	1.375	2.000	CN..54..	6.615
DCLNR/L206DAN	1.250	1.250	6.00	1.653	1.500	CN..64..	2.755
DCLNR/L246EAN	1.500	1.500	7.00	1.653	2.000	CN..64..	6.615

Reference							Nm
DCLNR/L124BAN	ICSN-442	1766	2712	1696	4295	5004	3.5
DCLNR/L164DAN	ICSN-442	1766	2712	1696	4295	5004	3.5
DCLNR/L204DAN	ICSN-442	1766	2712	1696	4295	5004	3.5
DCLNR/L205DAN	ICSN-533	1768	2716	1696	4295	5004	3.5
DCLNR/L245EAN	ICSN-533	1768	2716	1696	4295	5004	3.5
DCLNR/L206DAN	ICSN-633	1770	2719	1696	4295	5004	3.5
DCLNR/L246EAN	ICSN-633	1770	2719	1696	4295	5004	3.5

Optional clamping systems



M CLAMPING

Reference							Nm ¹	Nm ²
MCLN...43..AN	2613	1086	5003	ICSN-442	1657	5025	3.0	2.0
MCLN...54..AN	2614	1086	5003	ICSN-533	1673	5003	3.0	3.0
MCLN...64..AN	2614	1086	5003	ICSN-633	1674	5004	3.0	3.5



C CLAMPING

Reference							Nm
CCLN...43..AN	1766	ICSN-442	9414	2713	1086	5004	3.5
CCLN...45..AN	1766	ICSN-422	9414	2713	1086	5004	3.5
CCLN...54..AN	1768	ICSN-523	9414	2713	1086	5004	3.5
CCLN...64..AN	1770	ICSN-623	9414	2713	1086	5004	3.5



Characteristics:

Turning and profiling toolholder equipped with rhombic negative double-sided insert (angle 55°).

For low powered machines and small pieces choose toolholder Ref. SDJC (Page: A115).

Axial 6.25°
Radial -6.75°

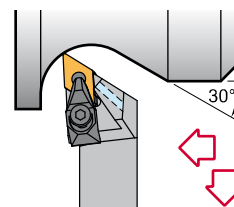
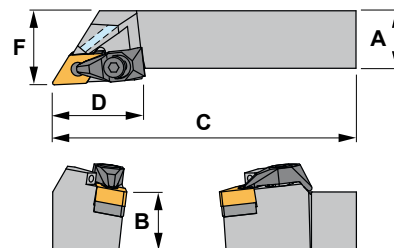

DDJN 93°-AN







Reference	A	B	C	D	F	Insert size	lbs
DDJNR/L124BAN	0.750	0.750	4.50	1.535	1.000	DN..43..	0.880
DDJNR/L164DAN	1.000	1.000	6.00	1.535	1.250	DN..43..	1.540
DDJNR/L204DAN	1.250	1.250	6.00	1.535	1.500	DN..43..	2.755
DDJNR/L244EAN	1.500	1.500	7.00	1.535	2.000	DN..43..	6.615

Reference							Nm
DDJNR/L124BAN	IDSN-442	1766	2712	1696	4295	5004	3.5
DDJNR/L164DAN	IDSN-442	1766	2712	1696	4295	5004	3.5
DDJNR/L204DAN	IDSN-442	1766	2712	1696	4295	5004	3.5
DDJNR/L244EAN	IDSN-442	1766	2712	1696	4295	5004	3.5

Optional clamping systems



M CLAMPING

Reference							Nm ¹	Nm ²
MDJN...43..AN	2613	1086	5003	IDSN-432	1657	5025	3.0	2.0



C CLAMPING

Reference							Nm
CDJN...43..AN	1766	IDSN-422	9416	2717	1086	5003	3.0



Characteristics:

Toolholder for specific operations equipped with square negative inserts and strong cutting edges.

For low powered machines and small pieces choose toolholder Ref. SSDC (Page: A122).

Axial -7°
Radial 0°

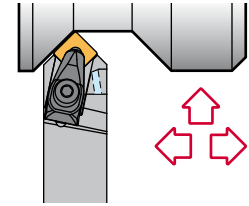
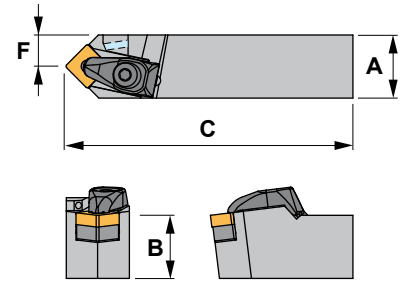

DSDN 45°-AN

Reference	A	B	C	F	Insert size	
DSDNN124BAN	0.750	0.750	4.50	0.375	SNM..43..	0.880
DSDNN164DAN	1.000	1.000	6.00	0.500	SNM..43..	1.540
DSDNN205DAN	1.250	1.250	6.00	0.625	SNM..54..	2.755
DSDNN206DAN	1.250	1.250	6.00	0.625	SNM..64..	2.755
DSDNN246EAN	1.500	1.500	7.00	0.750	SNM..64..	6.615

Reference							Nm
DSDNN124BAN	ISSN-442	1766	2712	1696	4295	5004	3.5
DSDNN164DAN	ISSN-442	1766	2712	1696	4295	5004	3.5
DSDNN205DAN	ISSN-533	1768	2716	1696	4295	5004	3.5
DSDNN206DAN	ISSN-633	1770	2719	1696	4295	5004	3.5
DSDNN246EAN	ISSN-633	1770	2719	1696	4295	5004	3.5

Optional clamping systems

M CLAMPING



Reference							Nm ¹	Nm ²
MSDN...43..AN	2613	1086	5003	ISSN-442	1657	5025	3.0	2.0
MSDN...54..AN	2614	1086	5003	ISSN-533	1673	5003	3.0	3.0
MSDN...64..AN	2614	1086	5003	ISSN-633	1674	5004	3.0	3.5

C CLAMPING



Reference							Nm
CSDN...43..AN	1766	ISSN-442	9414	2713	1086	5003	3.0
CSDN...45..AN	1766	ISSN-422	9414	2713	1086	5003	3.0

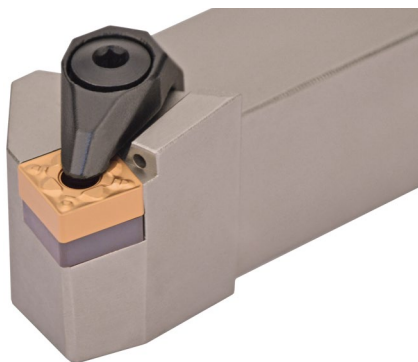

Characteristics:

Toolholder for specific operations equipped with square negative inserts and strong cutting edges. The double clamping (pin + clamp) ensures good rigidity and stability in roughing applications.

Axial -6°
Radial -6°

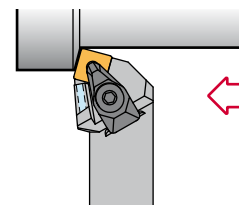
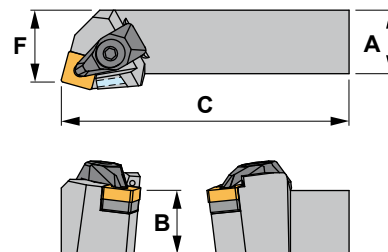

DSRN 75°-AN

Reference	A	B	C	D	F	Insert size	
DSRNR/L124BAN	0.750	0.750	4.50	1.375	0.880	SNM..43..	0.880
DSRNR/L164DAN	1.000	1.000	6.00	1.375	1.130	SNM..43..	1.540
DSRNR/L205DAN	1.250	1.250	6.00	1.375	1.353	SNM..54..	2.755
DSRNR/L206DAN	1.250	1.250	6.00	1.375	1.321	SNM..64..	2.755

Reference							Nm
DSRNR/L124BAN	ISSN-442	1766	2712	1696	4295	5004	3.5
DSRNR/L164DAN	ISSN-442	1766	2712	1696	4295	5004	3.5
DSRNR/L205DAN	ISSN-533	1768	2716	1696	4295	5004	3.5
DSRNR/L206DAN	ISSN-633	1770	2719	1696	4295	5004	3.5

Optional clamping systems

M CLAMPING

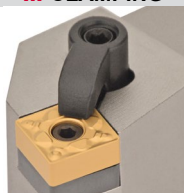

Reference							Nm ¹	Nm ²
MSRN...43..AN	2613	1086	5003	ISSN-442	1657	5025	3.0	2.0
MSRN...54..AN	2614	1086	5003	ISSN-533	1673	5003	3.0	3.0
MSRN...64..AN	2614	1086	5003	ISSN-633	1674	5004	3.0	3.5

C CLAMPING



Reference							Nm
CSRN...43..AN	1766	ISSN-442	9414	2713	1086	5003	3.0
CSRN...45..AN	1766	ISSN-422	9414	2713	1086	5003	3.0

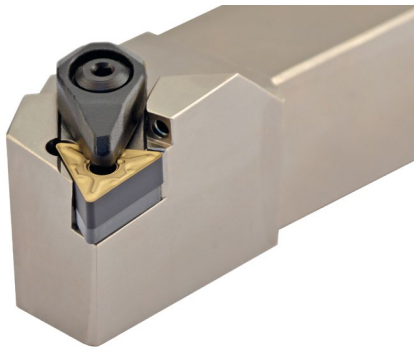

Characteristics:
 Multipurpose toolholder equipped with triangular negative double-sided inserts (angle 60°).
 For specific applications, roughing, semi-finishing and finishing.

Axial -6°
 Radial -6°

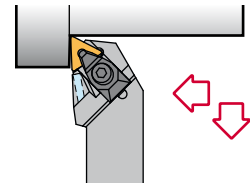
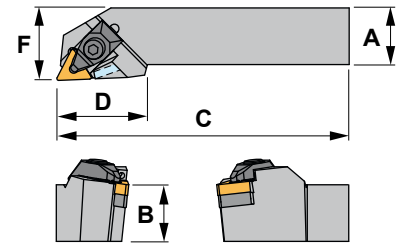

DTJN 93°-AN

Reference	A	B	C	D	F	Insert size	lbs
DTJNR/L123BAN	0.750	0.750	4.50	1.250	1.000	TNM..33..	0.880
DTJNR/L163DAN	1.000	1.000	6.00	1.250	1.250	TNM..33..	1.540
DTJNR/L164DAN	1.000	1.000	6.00	1.375	1.250	TNM..43..	1.540
DTJNR/L204DAN	1.250	1.250	6.00	1.250	1.500	TNM..43..	2.755
DTJNR/L244EAN	1.500	1.500	7.00	1.375	2.000	TNM..43..	6.615

Reference							Nm
DTJNR/L123BAN	ITSN-342	1764	2708	1695	4294	5004	3.5
DTJNR/L163DAN	ITSN-342	1764	2708	1695	4294	5004	3.5
DTJNR/L164DAN	ITSN-433	1766	2712	1696	4295	5004	3.5
DTJNR/L204DAN	ITSN-433	1766	2712	1696	4295	5004	3.5
DTJNR/L244EAN	ITSN-433	1766	2712	1696	4295	5004	3.5

TNM..

Triangular negative inserts. A37-38

Reference	l	T	d
TNM..33..	0.650	0.187	0.375
TNM..43..	0.866	0.187	0.500

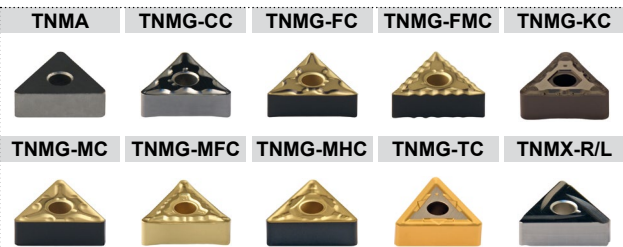
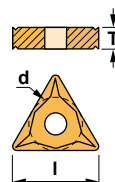

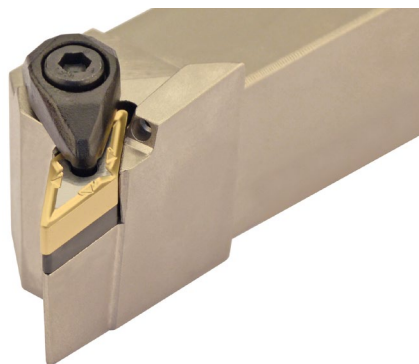

Characteristics: Toolholder for very specific operations equipped with rhombic negative inserts (angle 35°).

For low powered or poor rigid machines and small pieces, it is recommended to choose toolholder Ref. SVJC (Page: A131).

Axial -13°
Radial -4°

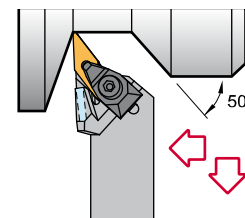
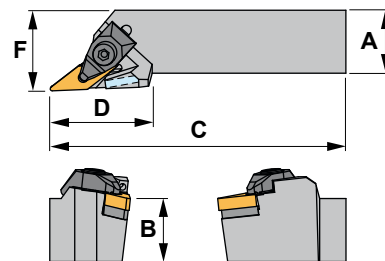

DVJN 93°-AN

Reference	A	B	C	D	F	Insert size	lbs
DVJNR/L123BAN	0.750	0.750	4.50	1.750	1.000	VN..33..	0.880
DVJNR/L163DAN	1.000	1.000	6.00	1.750	1.250	VN..33..	1.540
DVJNR/L203DAN	1.250	1.250	6.00	1.750	1.500	VN..33..	2.755
DVJNR/L243EAN	1.500	1.500	7.00	1.750	2.000	VN..33..	6.615

Reference							Nm
DVJNR/L123BAN	IVSN-322	1764	2708	1695	4294	5004	3.5
DVJNR/L163DAN	IVSN-322	1764	2708	1695	4294	5004	3.5
DVJNR/L203DAN	IVSN-322	1764	2708	1695	4294	5004	3.5
DVJNR/L243EAN	IVSN-322	1764	2708	1695	4294	5004	3.5

VN..

35° rhombic negative inserts. A41

Reference

l T d

VN..33.. 0.650 0.187 0.375

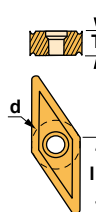

VNGP

VNMG



VNMG-TC



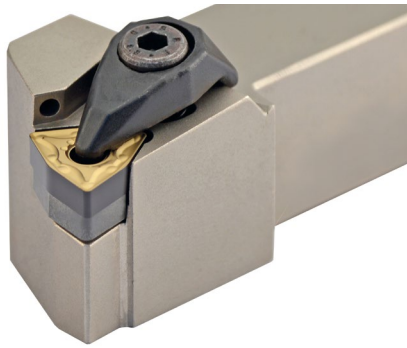

Characteristics:

Multipurpose toolholder equipped with trigon negative double-sided insert (angle 80°).

For top clamp toolholder see Ref. MWLN (Page: A99) or WWLN (Page: A75).

Axial -6°
Radial -6°

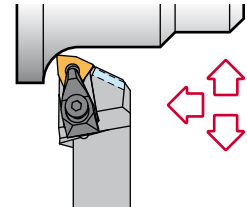
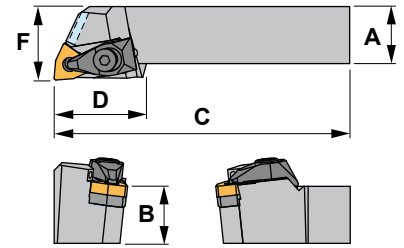

DWLN 95°-AN

Reference	A	B	C	D	F	Insert size	lbs
DWLN/L124BAN	0.750	0.750	4.50	1.250	1.000	WNMG43..	0.880
DWLN/L164DAN	1.000	1.000	6.00	1.250	1.250	WNMG43..	1.540
DWLN/L204DAN	1.250	1.250	6.00	1.250	1.500	WNMG43..	2.755
DWLN/L244EAN	1.500	1.500	7.00	1.250	2.000	WNMG43..	6.615

Reference							Nm
DWLN/L124BAN	IWSN-433	1766	2712	1696	4295	5004	3.5
DWLN/L164DAN	IWSN-433	1766	2712	1696	4295	5004	3.5
DWLN/L204DAN	IWSN-433	1766	2712	1696	4295	5004	3.5
DWLN/L244EAN	IWSN-433	1766	2712	1696	4295	5004	3.5

WNMG

80° trigon negative inserts. A42-43

Reference	l	T	d
WNMG43..	0.320	0.187	0.500

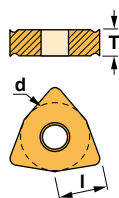

WNMG-FC WNMG-FMC WNMG-KC WNMG-MFC



WNMG-MC WNMG-MHC WNMG-TC





Characteristics:

Multipurpose toolholder equipped with rhombic negative double-sided insert (angle 80°).
For low powered machines and small pieces choose toolholder Ref. SCLC (Page: A112).

Axial -6,5°
Radial -6,5°

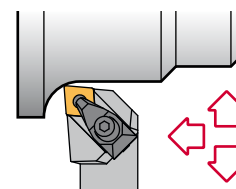
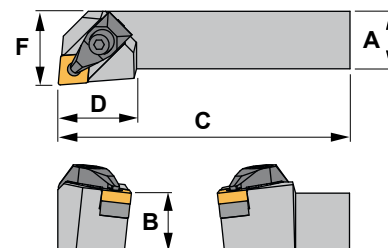

DCLN 95°-N

Reference	A	B	C	D	F	Insert size	lbs
DCLNR/L124BN	0.750	0.750	4.50	1.250	1.000	CN..43..	0.880
DCLNR/L164DN	1.000	1.000	6.00	1.250	1.250	CN..43..	1.540
DCLNR/L204DN	1.250	1.250	6.00	1.250	1.500	CN..43..	2.755
DCLNR/L205DN	1.250	1.250	6.00	1.375	1.500	CN..54..	2.755
DCLNR/L245EN	1.500	1.500	7.00	1.375	2.000	CN..54..	6.615
DCLNR/L206DN	1.250	1.250	6.00	1.653	1.500	CN..64..	2.755
DCLNR/L246EN	1.500	1.500	7.00	1.653	2.000	CN..64..	6.615

Reference							Nm
DCLNR/L124BN	ICSN-442	1766	2712	1696	4295	5004	3.5
DCLNR/L164DN	ICSN-442	1766	2712	1696	4295	5004	3.5
DCLNR/L204DN	ICSN-442	1766	2712	1696	4295	5004	3.5
DCLNR/L205DN	ICSN-533	1768	2716	1696	4295	5004	3.5
DCLNR/L245EN	ICSN-533	1768	2716	1696	4295	5004	3.5
DCLNR/L206DN	ICSN-633	1770	2719	1696	4295	5004	3.5
DCLNR/L246EN	ICSN-633	1770	2719	1696	4295	5004	3.5

Optional clamping systems



M CLAMPING

Reference							Nm ¹	Nm ²
MCLN...43..N	2613	1086	5003	ICSN-442	1657	5025	3.0	2.0
MCLN...54..N	2614	1086	5003	ICSN-533	1673	5003	3.0	3.0
MCLN...64..N	2614	1086	5003	ICSN-633	1674	5004	3.0	3.5



C CLAMPING

Reference							Nm
CCLN...43..N	1766	ICSN-442	9414	2713	1086	5004	3.5
CCLN...45..N	1766	ICSN-422	9414	2713	1086	5004	3.5
CCLN...54..N	1768	ICSN-523	9414	2713	1086	5004	3.5
CCLN...64..N	1770	ICSN-623	9414	2713	1086	5004	3.5

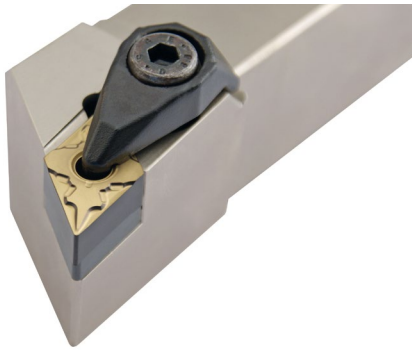

Characteristics:

Turning and profiling toolholder equipped with rhombic negative double-sided insert (angle 55°).

For low powered machines and small pieces choose toolholder Ref. SDJC (Page: A115).

Axial 6.25°
Radial -6.75°

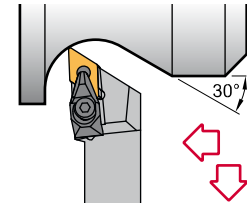
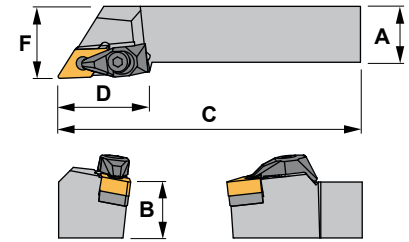

DDJN 93°-N

Reference	A	B	C	D	F	Insert size	
DDJNR/L124BN	0.750	0.750	4.50	1.535	1.000	DN..43..	0.880
DDJNR/L164DN	1.000	1.000	6.00	1.535	1.250	DN..43..	1.540
DDJNR/L204DN	1.250	1.250	6.00	1.535	1.500	DN..43..	2.755
DDJNR/L244EN	1.500	1.500	7.00	1.535	2.000	DN..43..	6.615

Reference							Nm
DDJNR/L124BN	IDSN-442	1766	2712	1696	4295	5004	3.5
DDJNR/L164DN	IDSN-442	1766	2712	1696	4295	5004	3.5
DDJNR/L204DN	IDSN-442	1766	2712	1696	4295	5004	3.5
DDJNR/L244EN	IDSN-442	1766	2712	1696	4295	5004	3.5

Optional clamping systems

M CLAMPING



Reference							Nm ¹	Nm ²
MDJN...43..N	2613	1086	5003	IDSN-432	1657	5025	3.0	2.0

C CLAMPING



Reference							Nm
CDJN...43..N	1766	IDSN-422	9416	2717	1086	5003	3.0

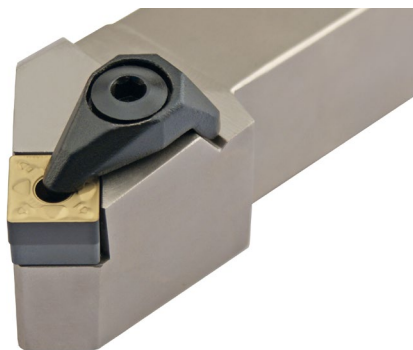

Characteristics:

Toolholder for external turning and chamfering applications equipped with square negative inserts.

The dimple lock ensures good rigidity and chip flow in roughing applications.

Axial -5.75°
Radial -5.75°

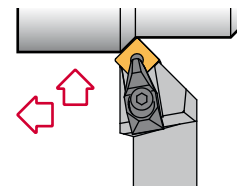
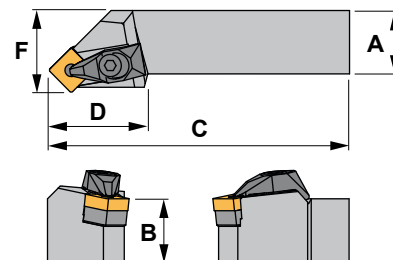

DSSN 45°-N

Reference	A	B	C	D	F	Insert size	
DSSNR/L124BN	0.750	0.750	4.50	1.457	1.000	SNM..43..	0.800
DSSNR/L164DN	1.000	1.000	6.00	1.457	1.250	SNM..43..	1.550
DSSNR/L204DN	1.250	1.250	6.00	1.457	1.500	SNM..43..	2.200
DSSNR/L206DN	1.250	1.250	6.00	1.772	1.500	SNM..64..	2.850
DSSNR/L246EN	1.500	1.500	7.00	1.772	2.000	SNM..64..	6.800

Reference							Nm
DSSNR/L124BN	ISSN-442	1766	2712	1696	4295	5004	3.5
DSSNR/L164DN	ISSN-442	1766	2712	1696	4295	5004	3.5
DSSNR/L204DN	ISSN-442	1766	2712	1696	4295	5004	3.5
DSSNR/L206DN	ISSN-633	1770	2719	1696	4295	5004	3.5
DSSNR/L246EN	ISSN-633	1770	2719	1696	4295	5004	3.5

Optional clamping systems

M CLAMPING



Reference								Nm ¹	Nm ²
MSSN...43..N	2613	1086	5003	ISSN-442	1657	5025		3.0	2.0
MSSN...54..N	2614	1086	5003	ISSN-533	1673	5003		3.0	3.0
MSSN...64..N	2614	1086	5003	ISSN-633	1674	5004		3.0	3.5

C CLAMPING



Reference							Nm
CSSN...43..N	1766	ISSN-442	9414	2713	1086	5003	3.0
CSSN...45..N	1766	ISSN-422	9414	2713	1086	5003	3.0

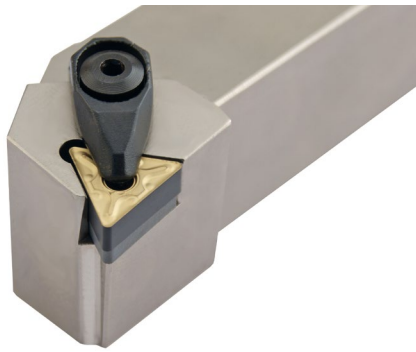

Characteristics:

Toolholder for external turning applications equipped with triangular negative inserts. For low powered machines and small pieces choose toolholder Ref. CTGP (Page: A108) or STGC (Page: A126).

Axial -6°
Radial -6°

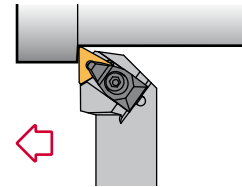
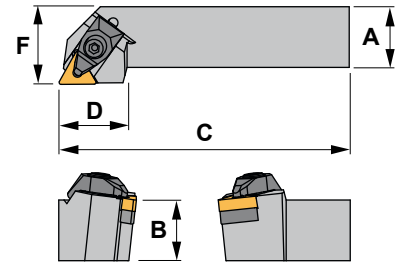

DTGN 90°-N

Reference	A	B	C	D	F	Insert size	
DTGNR/L123BN	0.750	0.750	4.50	1.102	1.000	TNM..33..	0.900
DTGNR/L163DN	1.000	1.000	6.00	1.102	1.250	TNM..33..	1.650
DTGNR/L164DN	1.000	1.000	6.00	1.338	1.250	TNM..43..	1.650
DTGNR/L204DN	1.250	1.250	6.00	1.338	1.500	TNM..43..	2.900

Reference							Nm
DTGNR/L123BN	ITSN-342	1764	2708	1695	4294	5004	3.5
DTGNR/L163DN	ITSN-342	1764	2708	1695	4294	5004	3.5
DTGNR/L164DN	ITSN-433	1766	2712	1696	4295	5004	3.5
DTGNR/L204DN	ITSN-433	1766	2712	1696	4295	5004	3.5

TNM..

Triangular negative inserts.  A37-38

Reference	l	T	d
TNM..33..	0.650	0.187	0.375
TNM..43..	0.866	0.187	0.500

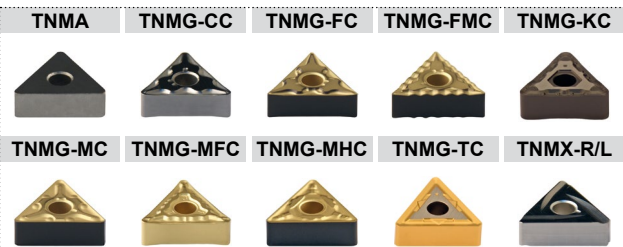
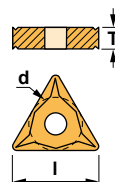



Characteristics:

Multipurpose toolholder equipped with trigon negative double-sided insert (angle 80°).

For top clamp toolholder see Ref. MWLN (Page: A99) or WWLN (Page: A75).

Axial -6°
Radial -6°

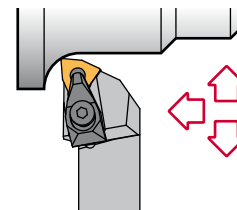
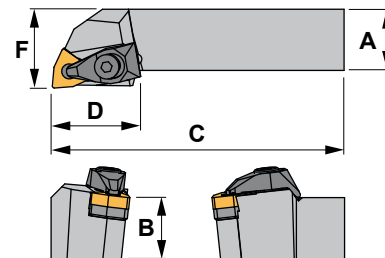

DWLN 95°-N

Reference	A	B	C	D	F	Insert size	
DWLN/L124BN	0.750	0.750	4.50	1.250	1.000	WNMG43..	0.880
DWLN/L164DN	1.000	1.000	6.00	1.250	1.250	WNMG43..	1.540
DWLN/L204DN	1.250	1.250	6.00	1.250	1.500	WNMG43..	2.755
DWLN/L244EN	1.500	1.500	7.00	1.250	2.000	WNMG43..	6.615

Reference							Nm
DWLN/L124BN	IWSN-433	1766	2712	1696	4295	5004	3.5
DWLN/L164DN	IWSN-433	1766	2712	1696	4295	5004	3.5
DWLN/L204DN	IWSN-433	1766	2712	1696	4295	5004	3.5
DWLN/L244EN	IWSN-433	1766	2712	1696	4295	5004	3.5

WNMG

80° trigon negative inserts.  A42-43

Reference	l	T	d
WNMG43..	0.320	0.187	0.500

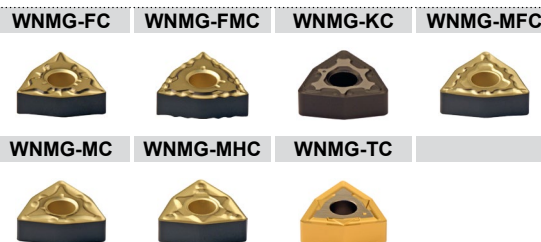
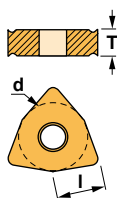

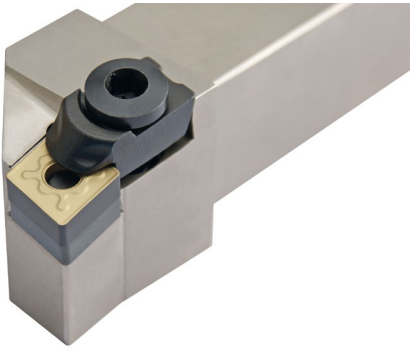

Characteristics:
 Multipurpose toolholder equipped with rhombic negative double-sided insert (angle 80°).
 For low powered machines and small pieces choose toolholder Ref. SCLC (Page: A112).

Axial -8°
 Radial -6.5°

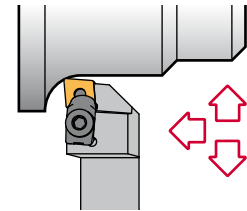
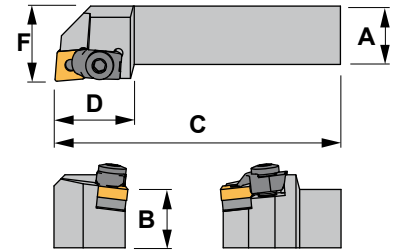

WCLN 95°

Reference	A	B	C	D	F	Insert size	lbs
WCLNR/L124B	0.750	0.750	4.50	1.130	1.000	CN..43..	0.990
WCLNR/L164D	1.000	1.000	6.00	1.130	1.250	CN..43..	1.760
WCLNR/L204D	1.250	1.250	6.00	1.130	1.500	CN..43..	2.640
WCLNR/L166D	1.000	1.000	6.00	1.510	1.250	CN..64..	1.760
WCLNR/L206D	1.250	1.250	6.00	1.510	1.500	CN..64..	2.640
WCLNR/L246D	1.500	1.500	6.00	1.510	2.000	CN..64..	6.820

Reference						Nm
WCLNR/L124B	2019	5105	ICSN-432	1661	1394	4.0
WCLNR/L164D	2019	5105	ICSN-432	1661	1394	4.0
WCLNR/L204D	2019	5105	ICSN-432	1661	1394	4.0
WCLNR/L166D	2029	5105	3619	1682	1296	4.0
WCLNR/L206D	2029	5105	3619	1682	1296	4.0
WCLNR/L246D	2029	5105	3619	1682	1296	4.0

CN.. 80° rhombic negative inserts. A24-26

Reference	l	T	d
CN..43..	0.508	0.187	0.500
CN..64..	0.760	0.250	0.750

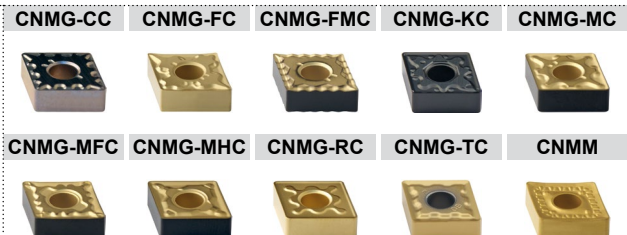
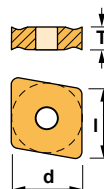

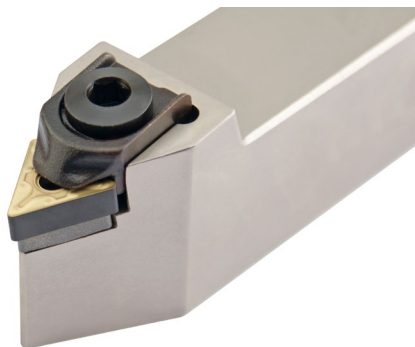

Characteristics:
 Profiling toolholder equipped with triangular negative double-sided insert (angle 60°).
 For general applications, roughing, semi-finishing and finishing.

Axial -8.25°
 Radial -2.25°

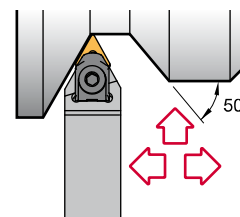
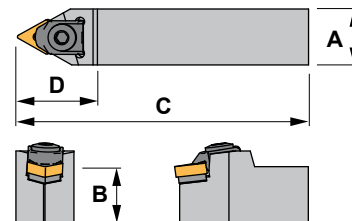

WTENNS 60°

Reference	A	B	C	D	Insert size	lbs
WTENNS123B	0.750	0.750	4.50	1.300	TNM..33..	0.990
WTENNS163D	1.000	1.000	6.00	1.300	TNM..33..	1.760
WTENNS164D	1.000	1.000	6.00	1.500	TNM..43..	1.760
WTENNS204D	1.250	1.250	6.00	1.500	TNM..43..	2.640

Reference						Nm
WTENNS123B	2013	5105	3414	1642	1393	4.0
WTENNS163D	2013	5105	3414	1642	1393	4.0
WTENNS164D	2029	5105	ITSN-433	1661	1394	4.0
WTENNS204D	2029	5105	ITSN-433	1661	1394	4.0

TNM..

Triangular negative inserts. A37-38

Reference	l	T	d
TNM..33..	0.650	0.187	0.375
TNM..43..	0.866	0.187	0.500

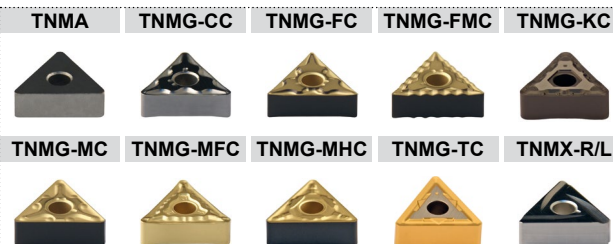
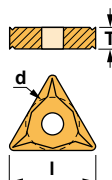





Characteristics:



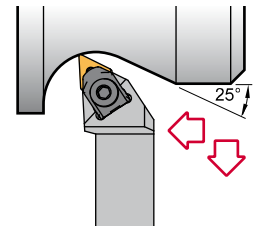
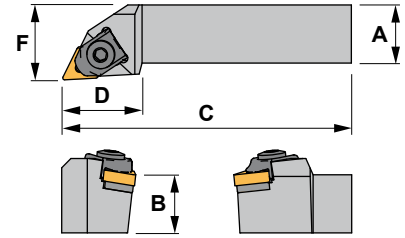

Turning and profiling toolholder equipped with triangular negative double-sided insert. The center pin and top clamp ensure good rigidity and stability in roughing applications.

Axial -6°
Radial -6°



WTJNS 93°

Reference	A	B	C	D	F	Insert size	
WTJNRS/LS123B	0.750	0.750	4.50	1.030	1.000	TNM..33..	0.990
WTJNRS/LS163D	1.000	1.000	6.00	1.030	1.250	TNM..33..	1.760
WTJNRS/LS164D	1.000	1.000	6.00	1.250	1.250	TNM..43..	1.760
WTJNRS/LS204D	1.250	1.250	6.00	1.250	1.500	TNM..43..	2.640

Reference						Nm
WTJNRS/LS123B	2013	5105	3414	1642	1393	4.0
WTJNRS/LS163D	2013	5105	3414	1642	1393	4.0
WTJNRS/LS164D	2029	5105	ITSN-433	1661	1394	4.0
WTJNRS/LS204D	2029	5105	ITSN-433	1661	1394	4.0

TNM..

Triangular negative inserts.  A37-38

Reference	l	T	d
TNM..33..	0.650	0.187	0.375
TNM..43..	0.866	0.187	0.500

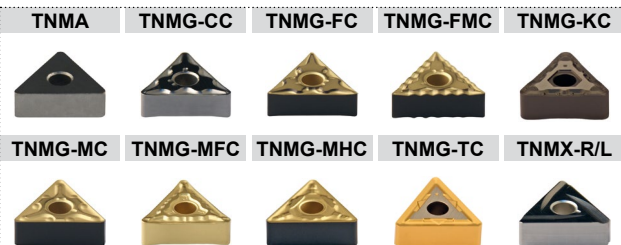
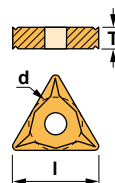

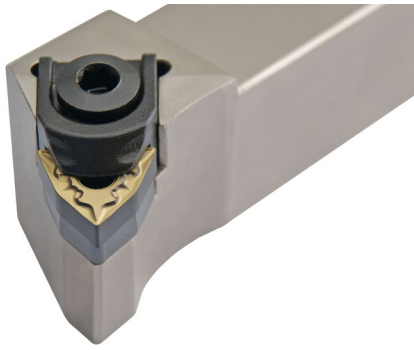

Characteristics:

Multipurpose toolholder equipped with trigon negative double-sided insert (angle 80°).

Not suitable for cermet, ceramic or K10 and P10 grade inserts.

Axial -6.5°
Radial -6.5°

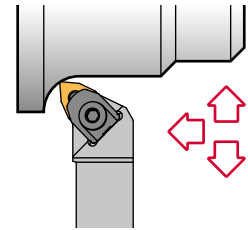
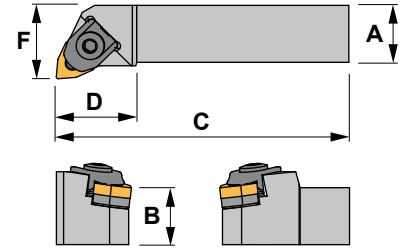

WWLN 95°

Reference	A	B	C	D	F	Insert size	 lbs
WWLNR/L124B	0.750	0.750	4.50	1.070	1.000	WNMG43..	0.990
WWLNR/L164D	1.000	1.000	6.00	1.070	1.250	WNMG43..	1.760
WWLNR/L204D	1.250	1.250	6.00	1.070	1.500	WNMG43..	2.640
WWLNR/L244E	1.500	1.500	7.00	1.070	2.000	WNMG43..	6.615

Reference						Nm
WWLNR/L124B	2012	5105	IWSN-433	1661	1394	4.0
WWLNR/L164D	2012	5105	IWSN-433	1661	1394	4.0
WWLNR/L204D	2012	5105	IWSN-433	1661	1394	4.0
WWLNR/L244E	2012	5105	IWSN-433	1661	1394	4.0

WNMG

80° trigon negative inserts.  A42-43

Reference	l	T	d
WNMG43..	0.320	0.187	0.500

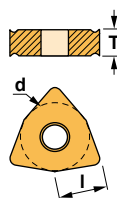

WNMG-FC WNMG-FMC WNMG-KC WNMG-MFC



WNMG-MC WNMG-MHC WNMG-TC



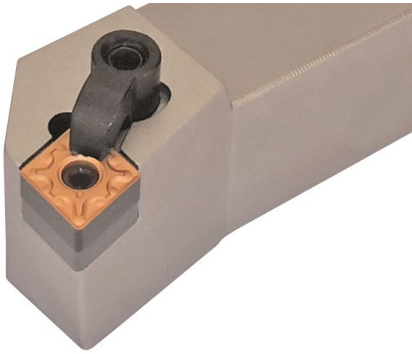

Characteristics:

Face turning toolholder equipped with rhombic negative double-sided inserts (angle 80°) with strong cutting edge. The double clamping (pin + clamp) ensures good rigidity and stability in roughing applications.

Axial -6°
Radial -6°

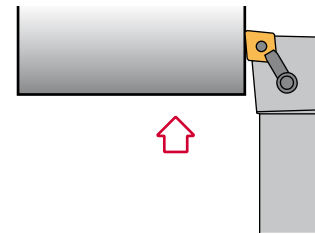
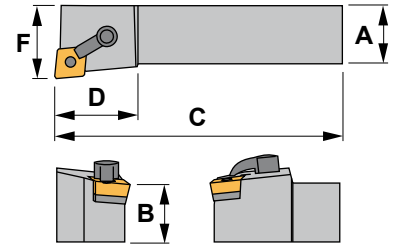

MCFN 90°

Reference	A	B	C	D	F	Insert size	
MCFNR/L124B	0.750	0.750	4.50	1.120	1.000	CN..43..	0.880
MCFNR/L164D	1.000	1.000	6.00	1.120	1.250	CN..43..	1.540
MCFNR/L204D	1.250	1.250	6.00	1.120	1.500	CN..43..	2.755
MCFNR/L854D	1.000	1.250	6.00	1.120	1.250	CN..43..	2.200
MCFNR/L165D	1.000	1.000	6.00	1.250	1.250	CN..54..	1.540
MCFNR/L205D	1.250	1.250	6.00	1.250	1.500	CN..54..	2.755
MCFNR/L245D	1.500	1.500	6.00	1.250	2.000	CN..54..	6.615
MCFNR/L166D	1.000	1.000	6.00	1.310	1.250	CN..64..	1.540
MCFNR/L206D	1.250	1.250	6.00	1.310	1.500	CN..64..	2.755
MCFNR/L246D	1.500	1.500	6.00	1.310	2.000	CN..64..	6.615

Reference								Nm ¹	Nm ²
MCFNR/L124B	CL-20	XNS-48	5103	ICSN-432	NL-46	5124		3.0	3.5
MCFNR/L164D	CL-20	XNS-48	5103	ICSN-432	NL-46	5124		3.0	3.5
MCFNR/L204D	CL-20	XNS-48	5103	ICSN-432	NL-46	5124		3.0	3.5
MCFNR/L854D	CL-20	XNS-48	5103	ICSN-432	NL-46	5124		3.0	3.5
MCFNR/L165D	CL-12	XNS-510	5004	ICSN-533	NL-58	5103		3.5	3.0
MCFNR/L205D	CL-12	XNS-510	5004	ICSN-533	NL-58	5103		3.5	3.0
MCFNR/L245D	CL-12	XNS-510	5004	ICSN-533	NL-58	5103		3.5	3.0
MCFNR/L166D	CL-12	XNS-510	5004	ICSN-633	NL-68	5135		3.5	4.0
MCFNR/L206D	CL-12	XNS-510	5004	ICSN-633	NL-68	5135		3.5	4.0
MCFNR/L246D	CL-12	XNS-510	5004	ICSN-633	NL-68	5103		3.5	3.0

CN..

80° rhombic negative inserts. A24-26

Reference	l	T	d
CN..43..	0.508	0.187	0.500
CN..54..	0.633	0.250	0.625
CN..64..	0.763	0.250	0.750

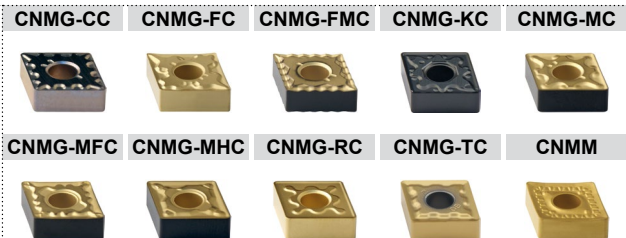
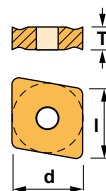

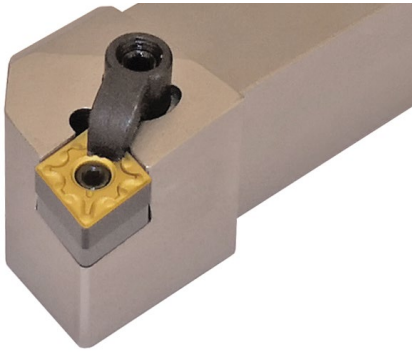

Characteristics:

Profiling toolholder equipped with rhombic negative double-sided inserts (angle 80°) with strong cutting edge. The double clamping (pin + clamp) ensures good rigidity and stability in roughing applications.

Axial -6°
Radial -6°

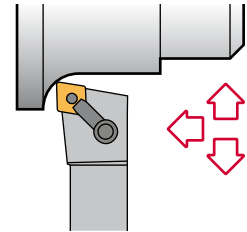
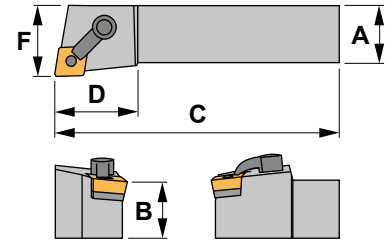

MCGN 90°

Reference	A	B	C	D	F	Insert size	
MCGNR/L124B	0.750	0.750	4.50	1.120	1.000	CN..43..	0.880
MCGNR/L164D	1.000	1.000	6.00	1.120	1.250	CN..43..	1.540
MCGNR/L204D	1.250	1.250	6.00	1.120	1.500	CN..43..	2.755
MCGNR/L244D	1.500	1.500	6.00	1.250	2.000	CN..43..	2.200
MCGNR/L165D	1.000	1.000	6.00	1.500	1.250	CN..54..	1.540
MCGNR/L205D	1.250	1.250	6.00	1.500	1.500	CN..54..	2.755
MCGNR/L245D	1.500	1.500	6.00	1.500	2.000	CN..54..	6.615
MCGNR/L206D	1.250	1.250	6.00	1.650	1.500	CN..64..	2.755
MCGNR/L246D	1.500	1.500	6.00	1.650	2.000	CN..64..	6.615

Reference							Nm ¹	Nm ²
MCGNR/L124B	CL-20	XNS-48	5103	ICSN-432	NL-46	5124	3.0	3.5
MCGNR/L164D	CL-20	XNS-48	5103	ICSN-432	NL-46	5124	3.0	3.5
MCGNR/L204D	CL-20	XNS-48	5103	ICSN-432	NL-46	5124	3.0	3.5
MCGNR/L244D	CL-20	XNS-48	5103	ICSN-432	NL-46	5124	3.0	3.5
MCGNR/L165D	CL-12	XNS-510	5004	ICSN-533	NL-58	5103	3.5	3.0
MCGNR/L205D	CL-12	XNS-510	5004	ICSN-533	NL-58	5103	3.5	3.0
MCGNR/L245D	CL-12	XNS-510	5004	ICSN-533	NL-58	5103	3.5	3.0
MCGNR/L206D	CL-12	XNS-510	5004	ICSN-633	NL-68	5135	3.5	4.0
MCGNR/L246D	CL-12	XNS-510	5004	ICSN-633	NL-68	5135	3.5	4.0

CN..

80° rhombic negative inserts. A24-26

Reference	l	T	d
CN..43..	0.508	0.187	0.500
CN..54..	0.633	0.250	0.625
CN..64..	0.763	0.250	0.750

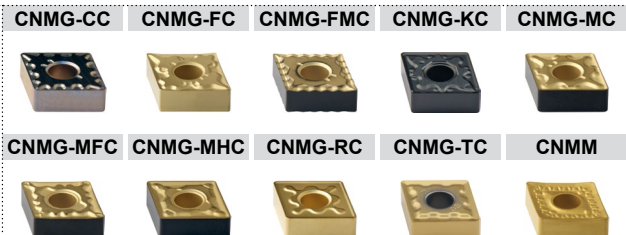
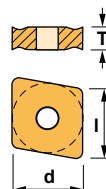

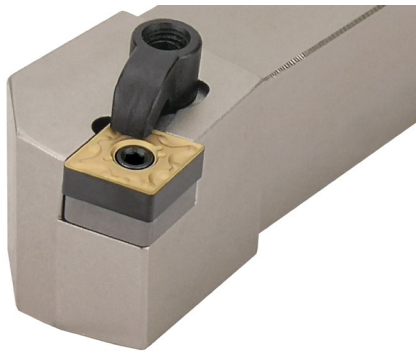

Characteristics:

Face turning toolholder equipped with rhombic negative double-sided inserts (angle 80°) with strong cutting edge. The double clamping (pin + clamp) ensures good rigidity and stability in roughing applications.

Axial -4°
Radial -7°

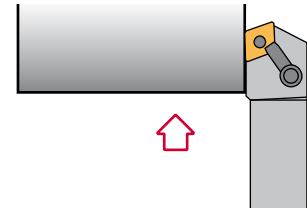
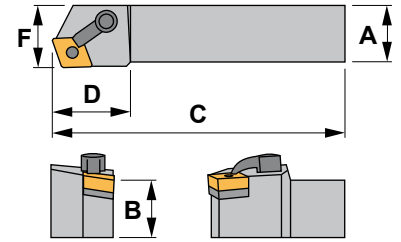

MCKN 75°

Reference	A	B	C	D	F	Insert size	
MCKNR/L124B	0.750	0.750	4.50	1.200	1.000	CN..43..	0.880
MCKNR/L164D	1.000	1.000	6.00	1.200	1.250	CN..43..	1.540
MCKNR/L204D	1.250	1.250	6.00	1.200	1.500	CN..43..	2.755
MCKNR/L165D	1.000	1.000	6.00	1.350	1.250	CN..54..	1.540
MCKNR/L205D	1.250	1.250	6.00	1.350	1.500	CN..54..	2.755
MCKNR/L166D	1.000	1.000	6.00	1.470	1.250	CN..64..	1.540
MCKNR/L206D	1.250	1.250	6.00	1.470	1.500	CN..64..	2.755
MCKNR/L246D	1.500	1.500	6.00	1.470	2.000	CN..64..	6.615

Reference								Nm ¹	Nm ²
MCKNR/L124B	CL-20	XNS-48	5103	ICSN-432	NL-46	5124		3.0	3.5
MCKNR/L164D	CL-20	XNS-48	5103	ICSN-432	NL-46	5124		3.0	3.5
MCKNR/L204D	CL-20	XNS-48	5103	ICSN-432	NL-46	5124		3.0	3.5
MCKNR/L165D	CL-12	XNS-510	5004	ICSN-533	NL-58	5103		3.5	3.0
MCKNR/L205D	CL-12	XNS-510	5004	ICSN-533	NL-58	5103		3.5	3.0
MCKNR/L166D	CL-12	XNS-510	5004	ICSN-633	NL-68	5135		3.5	4.0
MCKNR/L206D	CL-12	XNS-510	5004	ICSN-633	NL-68	5135		3.5	4.0
MCKNR/L246D	CL-12	XNS-510	5004	ICSN-633	NL-68	5135		3.5	4.0

CN.. 80° rhombic negative inserts. A24-26

Reference	l	T	d
CN..43..	0.508	0.187	0.500
CN..54..	0.633	0.250	0.625
CN..64..	0.763	0.250	0.750

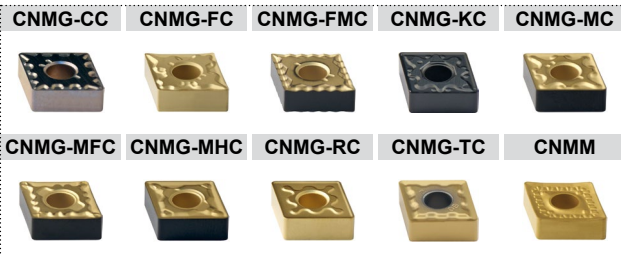
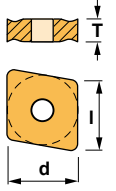

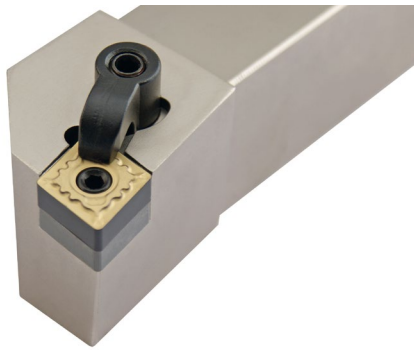

Characteristics:

Multipurpose toolholder equipped with rhombic negative double-sided insert (angle 80°).
For low powered machines and small pieces choose toolholder Ref. SCLC (Page: A112).

Axial -8°
Radial -6.25°

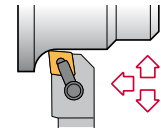
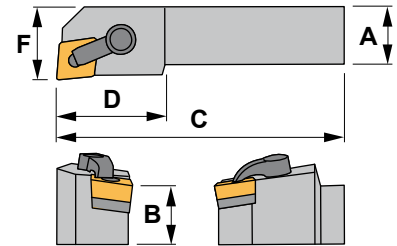

MCLN 95°

Reference	A	B	C	D	F	Insert size	lbs
MCLNR/L124B	0.750	0.750	4.50	1.130	1.000	CN..43..	0.880
MCLNR/L164D	1.000	1.000	6.00	1.130	1.250	CN..43..	1.540
MCLNR/L204D	1.250	1.250	6.00	1.130	1.500	CN..43..	2.755
MCLNR/L854D	1.000	1.250	6.00	1.130	1.250	CN..43..	2.200
MCLNR/L165D	1.000	1.000	6.00	1.470	1.250	CN..54..	1.540
MCLNR/L205D	1.250	1.250	6.00	1.470	1.500	CN..54..	2.755
MCLNR/L245D	1.500	1.500	6.00	1.470	2.000	CN..54..	6.615
MCLNR/L166D	1.000	1.000	6.00	1.510	1.250	CN..64..	1.540
MCLNR/L206D	1.250	1.250	6.00	1.510	1.500	CN..64..	2.755
MCLNR/L246D	1.500	1.500	6.00	1.510	2.000	CN..64..	6.615
MCLNR/L246E	1.500	1.500	7.00	1.500	2.000	CN..64..	6.615
MCLNR/L856D	1.000	1.250	6.00	1.510	1.250	CN..64..	2.200
MCLNR/L866E	1.000	1.500	7.00	1.510	1.250	CN..64..	3.100

Reference							Nm ¹	Nm ²
MCLNR/L124B	CL-20	XNS-48	5103	ICSN-432	NL-46	5124	3.0	3.5
MCLNR/L164D	CL-20	XNS-48	5103	ICSN-432	NL-46	5124	3.0	3.5
MCLNR/L204D	CL-20	XNS-48	5103	ICSN-432	NL-46	5124	3.0	3.5
MCLNR/L854D	CL-20	XNS-48	5103	ICSN-432	NL-46	5124	3.0	3.5
MCLNR/L165D	CL-12	XNS-510	5004	ICSN-533	NL-58	5103	3.5	3.0
MCLNR/L205D	CL-12	XNS-510	5004	ICSN-533	NL-58	5103	3.5	3.0
MCLNR/L245D	CL-12	XNS-510	5004	ICSN-533	NL-58	5103	3.5	3.0
MCLNR/L166D	CL-12	XNS-510	5004	ICSN-633	NL-68	5135	3.5	4.0
MCLNR/L206D	CL-12	XNS-510	5004	ICSN-633	NL-68	5135	3.5	4.0
MCLNR/L246D	CL-12	XNS-510	5004	ICSN-633	NL-68	5135	3.5	4.0
MCLNR/L246E	CL-12	XNS-510	5004	ICSN-633	NL-68	5135	3.5	4.0
MCLNR/L856D	CL-12	XNS-510	5004	ICSN-633	NL-68	5135	3.5	4.0
MCLNR/L866E	CL-12	XNS-510	5004	ICSN-633	NL-68	5135	3.5	4.0

CN..

80° rhombic negative inserts.  A24-26

Reference	l	T	d
CN..43..	0.508	0.187	0.500
CN..54..	0.633	0.250	0.625
CN..64..	0.763	0.250	0.750

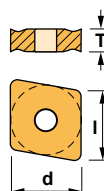

CNMG-CC CNMG-FC CNMG-FMC CNMG-KC CNMG-KC



CNMG-MFC CNMG-MHC CNMG-RC CNMG-TC CNMM





Characteristics:

Multipurpose toolholder equipped with rhombic negative double-sided inserts (angle 80°) with strong cutting edge. The double clamping (pin + clamp) ensures good rigidity and stability in roughing applications.

Axial -7°
Radial 0°

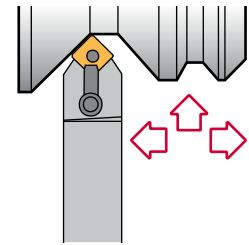
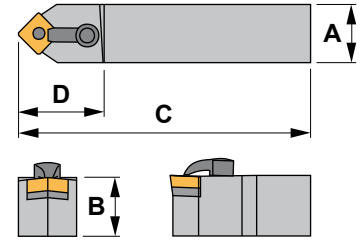

MCMN 50°

Reference	A	B	C	D	Insert size	
MCMNN124B	0.750	0.750	4.50	1.280	CN..43..	0.880
MCMNN164D	1.000	1.000	6.00	1.280	CN..43..	1.540
MCMNN204D	1.250	1.250	6.00	1.390	CN..43..	2.755
MCMNN854D	1.000	1.250	6.00	1.280	CN..43..	2.200
MCMNN165D	1.000	1.000	6.00	1.750	CN..54..	1.540
MCMNN205D	1.250	1.250	6.00	1.610	CN..54..	2.755
MCMNN245D	1.500	1.500	6.00	1.610	CN..54..	6.615
MCMNN246D	1.500	1.500	6.00	1.670	CN..64..	6.615

Reference							Nm ¹	Nm ²
MCMNN124B	CL-20	XNS-48	5103	ICSN-432	NL-46	5124	3.0	3.5
MCMNN164D	CL-20	XNS-48	5103	ICSN-432	NL-46	5124	3.0	3.5
MCMNN204D	CL-20	XNS-48	5103	ICSN-432	NL-46	5124	3.0	3.5
MCMNN854D	CL-20	XNS-48	5103	ICSN-432	NL-46	5124	3.0	3.5
MCMNN165D	CL-12	XNS-510	5004	ICSN-533	NL-58	5103	3.5	3.0
MCMNN205D	CL-12	XNS-510	5004	ICSN-533	NL-58	5103	3.5	3.0
MCMNN245D	CL-12	XNS-510	5004	ICSN-533	NL-58	5103	3.5	3.0
MCMNN246D	CL-12	XNS-510	5004	ICSN-633	NL-68	5103	3.5	3.0

CN..

80° rhombic negative inserts. A24-26

Reference

	l	T	d
CN..43..	0.508	0.187	0.500
CN..54..	0.633	0.250	0.625
CN..64..	0.763	0.250	0.750

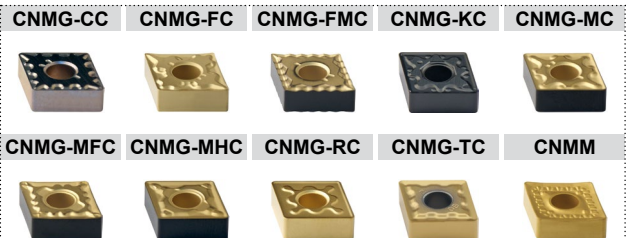
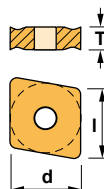

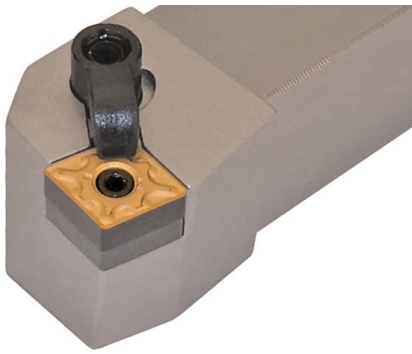

Characteristics:
 External turning toolholder equipped with rhombic negative double-sided inserts (angle 80°) with strong cutting edge. The double clamping (pin + clamp) ensures good rigidity and stability in roughing applications.

Axial -6°
 Radial -6°

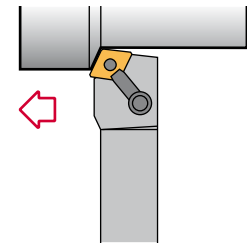
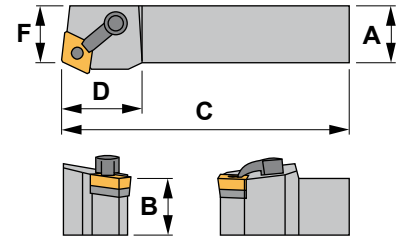

MCRN 75°

Reference	A	B	C	D	F	Insert size	lbs
MCRNR/L124B	0.750	0.750	4.50	1.180	0.878	CN..43..	0.880
MCRNR/L164D	1.000	1.000	6.00	1.180	1.128	CN..43..	1.540
MCRNR/L204D	1.250	1.250	6.00	1.180	1.318	CN..43..	2.755
MCRNR/L165D	1.000	1.000	6.00	1.101	1.101	CN..54..	1.540
MCRNR/L205D	1.250	1.250	6.00	1.351	1.351	CN..54..	2.755
MCRNR/L206D	1.250	1.250	6.00	1.318	1.318	CN..64..	2.755
MCRNR/L246D	1.500	1.500	6.00	1.818	1.818	CN..64..	6.615

Reference							Nm ¹	Nm ²
MCRNR/L124B	CL-20	XNS-48	5103	ICSN-432	NL-46	5124	3.0	3.5
MCRNR/L164D	CL-20	XNS-48	5103	ICSN-432	NL-46	5124	3.0	3.5
MCRNR/L204D	CL-20	XNS-48	5103	ICSN-432	NL-46	5124	3.0	3.5
MCRNR/L165D	CL-12	XNS-510	5004	ICSN-533	NL-58	5103	3.5	3.0
MCRNR/L205D	CL-12	XNS-510	5004	ICSN-533	NL-58	5103	3.5	3.0
MCRNR/L206D	CL-12	XNS-510	5004	ICSN-633	NL-68	5135	3.5	4.0
MCRNR/L246D	CL-12	XNS-510	5004	ICSN-633	NL-68	5135	3.5	4.0

CN..

80° rhombic negative inserts. A24-26

Reference	l	T	d
CN..43..	0.508	0.187	0.500
CN..54..	0.633	0.250	0.625
CN..64..	0.763	0.250	0.750

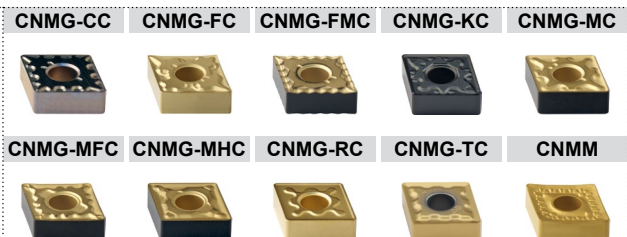
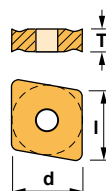



Characteristics:

Turning and profiling toolholder equipped with rhombic negative double-sided insert (angle 55°).

For low powered machines and small pieces choose toolholder Ref. SDJC (Page: A115).

Axial -6°
Radial -7°

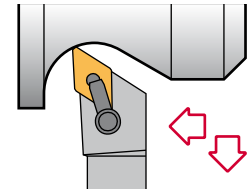
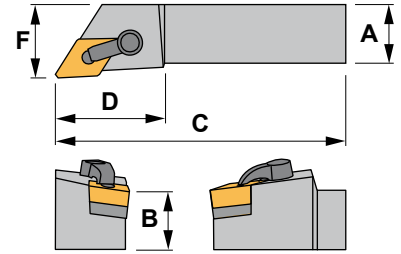

MDJN 93°

Reference	A	B	C	D	F	Insert size	
MDJNR/L083A	0.500	0.500	4.00	1.062	0.625	DN..33..	0.155
MDJNR/L103B	0.625	0.625	4.50	1.250	0.875	DN..33..	0.440
MDJNR/L124B	0.750	0.750	4.50	1.500	1.000	DN..43..	0.880
MDJNR/L164D	1.000	1.000	6.00	1.500	1.250	DN..43..	1.540
MDJNR/L204D	1.250	1.250	6.00	1.500	1.500	DN..43..	2.755
MDJNR/L244D	1.500	1.500	6.00	1.500	2.000	DN..43..	6.615
MDJNR/L854D	1.000	1.250	6.00	1.500	1.250	DN..43..	2.200
MDJNR/L165D	1.000	1.000	6.00	1.440	1.250	DN..54..	1.540
MDJNR/L205D	1.250	1.250	6.00	1.440	1.500	DN..54..	2.755
MDJNR/L245D	1.500	1.500	6.00	1.440	2.000	DN..54..	6.615
MDJNR/L855D	1.000	1.250	6.00	1.440	1.250	DN..54..	2.200

Reference							Nm ¹	Nm ²
MDJNR/L083A	CL-7	XNS-36	5124	-	NL-33L	5102	3.5	1.4
MDJNR/L103B	CL-7	XNS-36	5124	-	NL-33L	5102	3.5	1.4
MDJNR/L124B	CL-20	XNS-48	5103	IDSN-432	NL-46	5124	3.0	3.5
MDJNR/L164D	CL-20	XNS-48	5103	IDSN-432	NL-46	5124	3.0	3.5
MDJNR/L204D	CL-20	XNS-48	5103	IDSN-432	NL-46	5124	3.0	3.5
MDJNR/L244D	CL-20	XNS-48	5103	IDSN-432	NL-46	5124	3.0	3.5
MDJNR/L854D	CL-20	XNS-48	5103	IDSN-432	NL-46	5124	3.0	3.5
MDJNR/L165D	CL-12	XNS-510	5004	IDSN-533	NL-58	5103	3.5	3.0
MDJNR/L205D	CL-12	XNS-510	5004	IDSN-533	NL-58	5103	3.5	3.0
MDJNR/L245D	CL-12	XNS-510	5004	IDSN-533	NL-58	5103	3.5	3.0
MDJNR/L855D	CL-12	XNS-510	5004	IDSN-533	NL-58	5103	3.5	3.0

DN..

55° rhombic negative inserts. A28-30

Reference	l	T	d
DN..33..	0.457	0.187	0.375
DN..43..	0.610	0.187	0.500
DN..54..	0.764	0.250	0.625

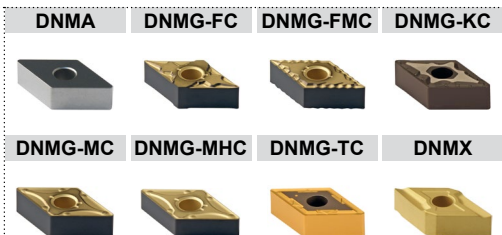
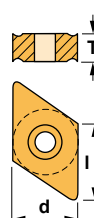

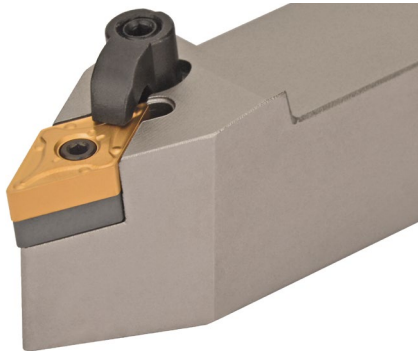

Characteristics:

Copying toolholder equipped with rhombic negative double-sided inserts (angle 55°) with strong cutting edge.

For low powered machines and small pieces choose toolholder Ref. SDPC (Page: A118).

Axial -8°
Radial 0°

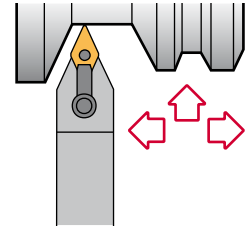
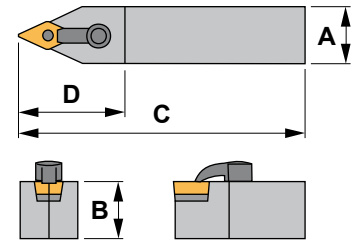

MDPN 62°30'

Reference	A	B	C	D	Insert size	lbs
MDPNN124B	0.750	0.750	4.50	1.620	DN..43..	0.880
MDPNN164D	1.000	1.000	6.00	1.620	DN..43..	1.540
MDPNN204D	1.250	1.250	6.00	1.620	DN..43..	2.755
MDPNN165D	1.000	1.000	6.00	1.880	DN..54..	1.540
MDPNN205D	1.250	1.250	6.00	1.880	DN..54..	2.755
MDPNN245E	1.500	1.500	7.00	1.880	DN..54..	6.615
MDPNN855D	1.000	1.250	6.00	1.880	DN..54..	2.200
MDPNN865D	1.000	1.500	6.00	1.880	DN..54..	3.100

Reference							Nm ¹	Nm ²
MDPNN124B	CL-22	XNS-48	5103	IDSN-432	NL-46	5124	3.0	3.5
MDPNN164D	CL-20	XNS-48	5103	IDSN-432	NL-46	5124	3.0	3.5
MDPNN204D	CL-20	XNS-48	5103	IDSN-432	NL-46	5124	3.0	3.5
MDPNN165D	CL-12	XNS-510	5004	IDSN-533	NL-58	5103	3.5	3.0
MDPNN205D	CL-12	XNS-510	5004	IDSN-533	NL-58	5103	3.5	3.0
MDPNN245E	CL-12	XNS-510	5004	IDSN-533	NL-58	5103	3.5	3.0
MDPNN855D	CL-12	XNS-510	5004	IDSN-533	NL-58	5103	3.5	3.0
MDPNN865D	CL-12	XNS-510	5004	IDSN-533	NL-58	5103	3.5	3.0

DN..

55° rhombic negative inserts. A28-30

Reference	l	T	d
DN..43..	0.610	0.187	0.500
DN..54..	0.764	0.250	0.625

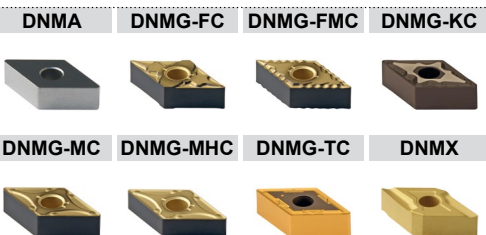



Characteristics:

Multipurpose toolholder equipped with rhombic negative double-sided insert (angle 55°).
For low powered machines and small pieces choose toolholder Ref. SDJC (Page: A115).

Axial -6°
Radial -6°

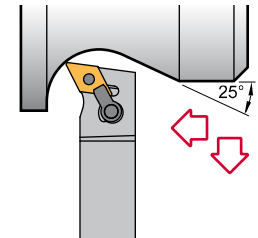
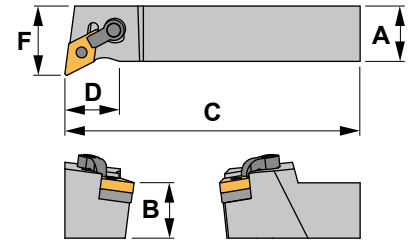

MDQN 107°30'

Reference	A	B	C	D	F	Insert size	
MDQNR/L124B	0.750	0.750	4.50	1.370	1.000	DN..43..	0.880
MDQNR/L164D	1.000	1.000	6.00	1.370	1.250	DN..43..	1.540
MDQNR/L204D	1.250	1.250	6.00	1.370	1.500	DN..43..	2.755
MDQNR/L244E	1.500	1.500	7.00	1.370	2.000	DN..43..	6.615

Reference							Nm ¹	Nm ²
MDQNR/L124B	CL-20	XNS-48	5103	IDSN-432	NL-46	5124	3.0	3.5
MDQNR/L164D	CL-20	XNS-48	5103	IDSN-432	NL-46	5124	3.0	3.5
MDQNR/L204D	CL-20	XNS-48	5103	IDSN-432	NL-46	5124	3.0	3.5
MDQNR/L244E	CL-20	XNS-48	5103	IDSN-432	NL-46	5124	3.0	3.5

DN..

55° rhombic negative inserts. A28-30

Reference

Reference	l	T	d
DN..43..	0.610	0.187	0.500

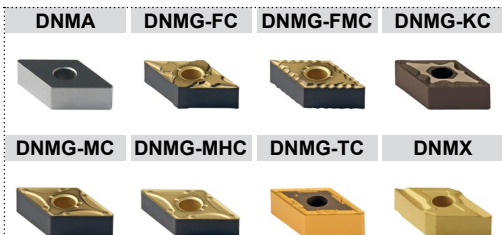

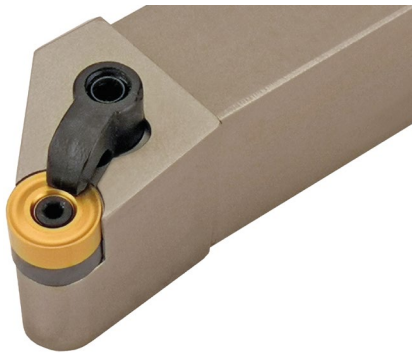
**Characteristics:**

Toolholder equipped with round negative inserts with strong cutting edge.
For low powered machines and small pieces choose toolholder Ref. SRGC (Page: A120).

Axial -7°
Radial -7°

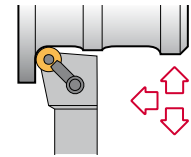
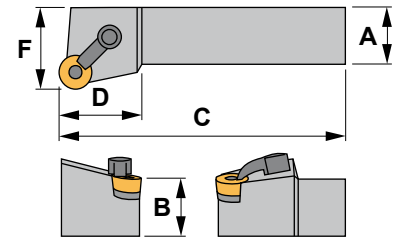

MRGN

Reference	A	B	C	D	F	Insert size	
MRGNR/L123B	0.750	0.750	4.50	0.810	1.000	RNMG32..	0.880
MRGNR/L124B	0.750	0.750	4.50	1.060	1.000	RNMG43..	0.880
MRGNR/L164D	1.000	1.000	6.00	1.060	1.250	RNMG43..	1.540
MRGNR/L204D	1.250	1.250	6.00	1.060	1.500	RNMG43..	2.755
MRGNR/L854D	1.000	1.250	6.00	1.060	1.250	RNMG43..	2.200
MRGNR/L864D	1.000	1.500	6.00	1.060	1.250	RNMG43..	3.100
MRGNR/L165D	1.000	1.000	6.00	1.250	1.250	RNMG54..	1.540
MRGNR/L205D	1.250	1.250	6.00	1.250	1.500	RNMG54..	2.755
MRGNR/L166D	1.000	1.000	6.00	1.380	1.250	RNMG64..	1.540
MRGNR/L206D	1.250	1.250	6.00	1.380	1.500	RNMG64..	2.755
MRGNR/L246E	1.500	1.500	7.00	1.380	2.000	RNMG64..	6.615
MRGNR/L248E	1.500	1.500	7.00	1.440	2.000	RNMG86..	6.615

Reference							Nm ¹	Nm ²
MRGNR/L123B	CL-20	XNS-48	5103	-	NL-33	5102	3.0	1.4
MRGNR/L124B	CL-20	XNS-48	5103	IRSN-43	NL-46	5124	3.0	3.5
MRGNR/L164D	CL-20	XNS-48	5103	IRSN-43	NL-46	5124	3.0	3.5
MRGNR/L204D	CL-20	XNS-48	5103	IRSN-43	NL-46	5124	3.0	3.5
MRGNR/L854D	CL-20	XNS-48	5103	IRSN-43	NL-46	5124	3.0	3.5
MRGNR/L864D	CL-20	XNS-48	5103	IRSN-43	NL-46	5124	3.0	3.5
MRGNR/L165D	CL-12	XNS-510	5004	IRSN-53	NL-58	5103	3.5	3.0
MRGNR/L205D	CL-12	XNS-510	5004	IRSN-53	NL-58	5103	3.5	3.0
MRGNR/L166D	CL-12	XNS-510	5004	IRSN-63	NL-68	5135	3.5	4.0
MRGNR/L206D	CL-12	XNS-510	5004	IRSN-63	NL-68	5135	3.5	4.0
MRGNR/L246E	CL-12	XNS-510	5004	IRSN-63	NL-68	5135	3.5	4.0
MRGNR/L248E	CL-30	XNS-510	5004	IRSN-84	NL-810	5004	3.5	3.5

RNMG

Round negative insert.  A31

Reference	T	d
RNMG32..	0.125	0.375
RNMG43..	0.187	0.500
RNMG54..	0.250	0.625
RNMG64..	0.250	0.750
RNMG86..	0.375	1.000

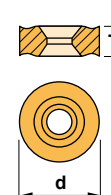

RNMG



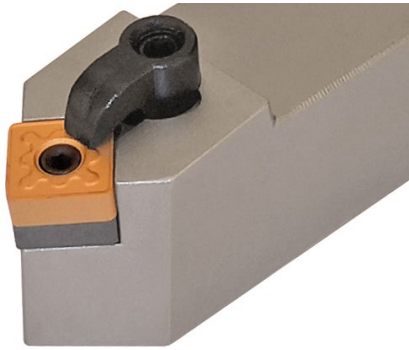

Characteristics:

Toolholder for specific operations equipped with square negative inserts and strong cutting edges.

For low powered machines and small pieces choose toolholder Ref. SSDC (Page: A122).

Axial -7°
Radial 0°

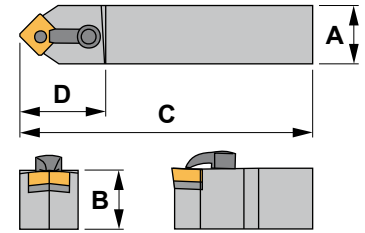

MSDN 45°

Reference	A	B	C	D	Insert size	
MSDNN083A	0.500	0.500	4.00	1.000	SNM..32..	0.155
MSDNN103B	0.625	0.625	4.50	1.000	SNM..32..	0.440
MSDNN124B	0.750	0.750	4.50	1.300	SNM..43..	0.880
MSDNN164D	1.000	1.000	6.00	1.300	SNM..43..	1.540
MSDNN854D	1.000	1.250	6.00	1.300	SNM..43..	2.200
MSDNN165D	1.000	1.000	6.00	1.500	SNM..54..	1.540
MSDNN205D	1.250	1.250	6.00	1.500	SNM..54..	2.755
MSDNN855D	1.000	1.250	6.00	1.500	SNM..54..	2.200
MSDNN166D	1.000	1.000	6.00	1.730	SNM..64..	1.540
MSDNN206D	1.250	1.250	6.00	1.750	SNM..64..	2.755
MSDNN246E	1.500	1.500	7.00	1.750	SNM..64..	6.615
MSDNN856D	1.000	1.250	6.00	1.750	SNM..64..	2.200

Reference							Nm ¹	Nm ²
MSDNN083A	CL-6	XNS-36	5124	ISSN-322	NL-34	5102	3.5	1.4
MSDNN103B	CL-6	XNS-36	5124	ISSN-322	NL-34	5102	3.5	1.4
MSDNN124B	CL-20	XNS-48	5103	ISSN-432	NL-46	5124	3.0	3.5
MSDNN164D	CL-20	XNS-48	5103	ISSN-432	NL-46	5124	3.0	3.5
MSDNN854D	CL-20	XNS-48	5103	ISSN-432	NL-46	5124	3.0	3.5
MSDNN165D	CL-12	XNS-510	5004	ISSN-533	NL-58	5103	3.5	3.0
MSDNN205D	CL-12	XNS-510	5004	ISSN-533	NL-58	5103	3.5	3.0
MSDNN855D	CL-12	XNS-510	5004	ISSN-533	NL-58	5103	3.5	3.0
MSDNN166D	CL-12	XNS-510	5004	ISSN-633	NL-68	5135	3.5	4.0
MSDNN206D	CL-12	XNS-510	5004	ISSN-633	NL-68	5135	3.5	4.0
MSDNN246E	CL-12	XNS-510	5004	ISSN-633	NL-68	5135	3.5	4.0
MSDNN856D	CL-12	XNS-510	5004	ISSN-633	NL-68	5135	3.5	4.0

SNM..

Square negative inserts. A33-34

Reference	l	T	d
SNM..32..	0.375	0.125	0.375
SNM..43..	0.500	0.187	0.500
SNM..54..	0.625	0.250	0.625
SNM..64..	0.750	0.250	0.750

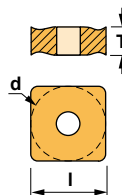

SNMG-FMC



SNMG-KC



SNMG-MHC



SNMG-RC



SNMG-TC



SNMM



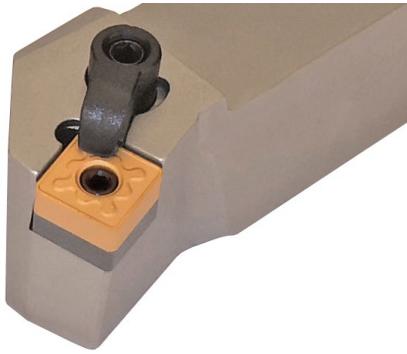

Characteristics:

Toolholder for specific operations equipped with square negative inserts and strong cutting edges. Face turning toolholder for general applications, roughing, semi-finishing and finishing.

Axial -4°
Radial -7°

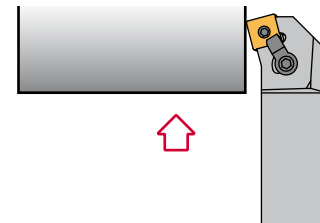
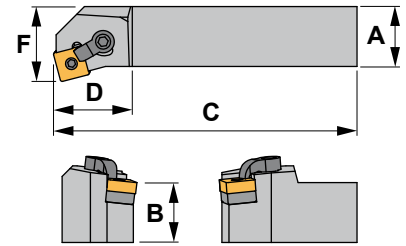

MSKN 75°

Reference	A	B	C	D	F	Insert size	lbs
MSKNR/L124B	0.750	0.750	4.50	1.220	1.000	SNM..43..	0.880
MSKNR/L164D	1.000	1.000	6.00	1.220	1.250	SNM..43..	1.540
MSKNR/L165D	1.000	1.000	6.00	1.410	1.250	SNM..54..	1.540
MSKNR/L205D	1.250	1.250	6.00	1.410	1.500	SNM..54..	2.755
MSKNR/L855D	1.000	1.250	6.00	1.410	1.250	SNM..54..	2.200
MSKNR/L206D	1.250	1.250	6.00	1.500	1.500	SNM..64..	2.755
MSKNR/L246E	1.500	1.500	7.00	1.500	2.000	SNM..64..	6.615

Reference							Nm ¹	Nm ²
MSKNR/L124B	CL-20	XNS-48	5103	ISSN-432	NL-46	5124	3.0	3.5
MSKNR/L164D	CL-20	XNS-48	5103	ISSN-432	NL-46	5124	3.0	3.5
MSKNR/L165D	CL-12	XNS-510	5004	ISSN-533	NL-58	5103	3.5	3.0
MSKNR/L205D	CL-12	XNS-510	5004	ISSN-533	NL-58	5103	3.5	3.0
MSKNR/L855D	CL-12	XNS-510	5004	ISSN-533	NL-58	5103	3.5	3.0
MSKNR/L206D	CL-12	XNS-510	5004	ISSN-633	NL-68	5135	3.5	4.0
MSKNR/L246E	CL-12	XNS-510	5004	ISSN-633	NL-68	5135	3.5	4.0

SNM..

Square negative inserts. A33-34

Reference

l

T

d

SNM..43..

0.500

0.187

0.500

SNM..54..

0.625

0.250

0.625

SNM..64..

0.750

0.250

0.750

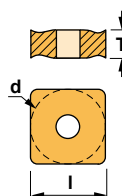

SNMG-FMC

SNMG-KC

SNMG-MHC



SNMG-RC

SNMG-TC

SNMM



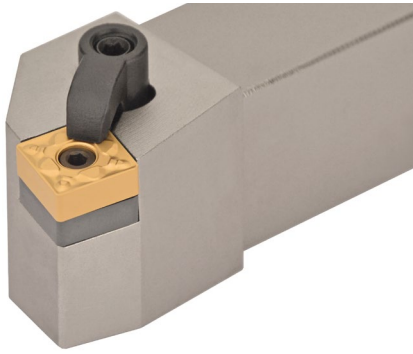

Characteristics:

Toolholder for specific operations equipped with square negative inserts and strong cutting edges.





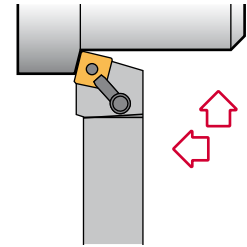
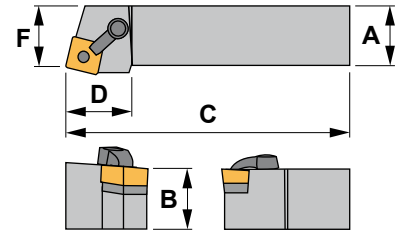

External toolholder for general applications, roughing, semi-finishing and finishing.

Axial -7°
Radial -5°



MSRN 75°

Reference	A	B	C	D	F	Insert size	lbs
MSRNR/L124B	0.750	0.750	4.50	1.250	0.880	SNM..43..	0.880
MSRNR/L164D	1.000	1.000	6.00	1.250	1.130	SNM..43..	1.540
MSRNR/L165D	1.000	1.000	6.00	1.500	1.103	SNM..54..	1.540
MSRNR/L205D	1.250	1.250	6.00	1.500	1.353	SNM..54..	2.755
MSRNR/L206D	1.250	1.250	6.00	1.590	1.321	SNM..64..	2.755
MSRNR/L246E	1.500	1.500	7.00	1.590	1.821	SNM..64..	6.615
MSRNR/L248E	1.500	1.500	7.00	1.890	1.770	SNM..85..	6.750

Reference							Nm ¹	Nm ²
MSRNR/L124B	CL-20	XNS-48	5103	ISSN-432	NL-46	5124	3.0	3.5
MSRNR/L164D	CL-20	XNS-48	5103	ISSN-432	NL-46	5124	3.0	3.5
MSRNR/L165D	CL-12	XNS-510	5004	ISSN-533	NL-58	5103	3.5	3.0
MSRNR/L205D	CL-12	XNS-510	5004	ISSN-533	NL-58	5103	3.5	3.0
MSRNR/L206D	CL-12	XNS-510	5004	ISSN-633	NL-68	5135	3.5	4.0
MSRNR/L246E	CL-12	XNS-510	5004	ISSN-633	NL-68	5135	3.5	4.0
MSRNR/L248E	CL-30	XNS-510	5004	ISSN-846	NL-810	5004	3.5	3.5

SNM..

Square negative inserts.  A33-34

Reference	l	T	d
SNM..43..	0.500	0.187	0.500
SNM..54..	0.625	0.250	0.625
SNM..64..	0.750	0.250	0.750
SNM..85..	1.000	0.312	1.000

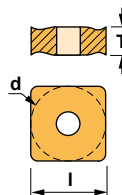

SNMG-FMC



SNMG-KC



SNMG-MHC



SNMG-RC



SNMG-TC



SNMM



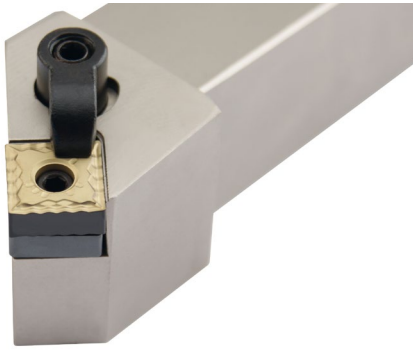

Characteristics: Toolholder for external turning and chamfering applications equipped with square negative inserts.
For low powered machines and small pieces choose toolholder Ref. SSDC (Page: A122).

Axial -6°
Radial -6°

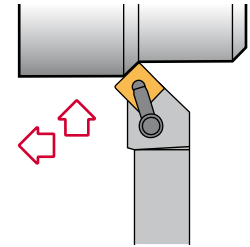
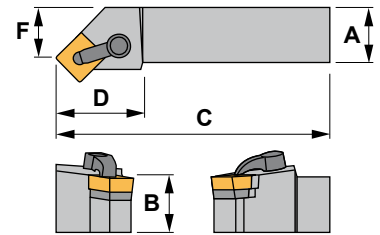

MSSN 45°

Reference	A	B	C	D	F	Insert size	lbs
MSSNR/L124B	0.750	0.750	4.50	1.230	0.675	SNM..43..	0.880
MSSNR/L164D	1.000	1.000	6.00	1.230	0.925	SNM..43..	1.540
MSSNR/L165D	1.000	1.000	6.00	1.380	0.847	SNM..54..	1.540
MSSNR/L205D	1.250	1.250	6.00	1.380	1.097	SNM..54..	2.755
MSSNR/L206D	1.250	1.250	6.00	1.470	1.011	SNM..64..	2.755
MSSNR/L246E	1.500	1.500	7.00	1.470	1.511	SNM..64..	6.615
MSSNR/L866E	1.000	1.500	7.00	1.470	0.761	SNM..64..	3.100

Reference							Nm ¹	Nm ²
MSSNR/L124B	CL-20	XNS-48	5103	ISSN-432	NL-46	5124	3.0	3.5
MSSNR/L164D	CL-20	XNS-48	5103	ISSN-432	NL-46	5124	3.0	3.5
MSSNR/L165D	CL-12	XNS-510	5004	ISSN-533	NL-58	5103	3.5	3.0
MSSNR/L205D	CL-12	XNS-510	5004	ISSN-533	NL-58	5103	3.5	3.0
MSSNR/L206D	CL-12	XNS-510	5004	ISSN-633	NL-68	5135	3.5	4.0
MSSNR/L246E	CL-12	XNS-510	5004	ISSN-633	NL-68	5135	3.5	4.0
MSSNR/L866E	CL-12	XNS-510	5004	ISSN-633	NL-68	5135	3.5	4.0

SNM..

Square negative inserts. A33-34

Reference

l

T

d

SNM..43..

0.500

0.187

0.500

SNM..54..

0.625

0.250

0.625

SNM..64..

0.750

0.250

0.750

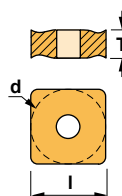

SNMG-FMC

SNMG-KC

SNMG-MHC



SNMG-RC

SNMG-TC

SNMM



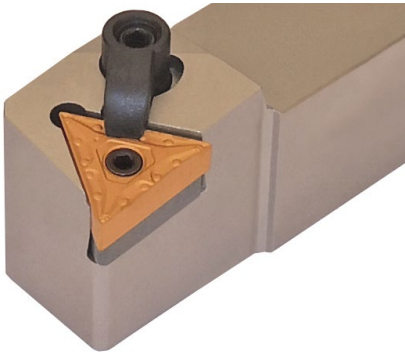

Characteristics:

Profiling toolholder equipped with negative double-sided inserts with strong cutting edges. For low powered machines and small pieces choose toolholder Ref. STGC (Page: A126).

Axial -6°
Radial -6°

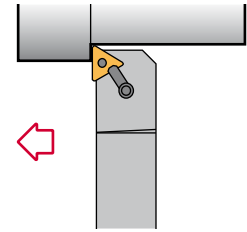
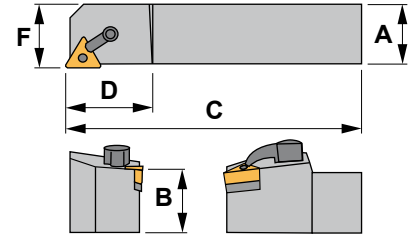

MTAN 90°

Reference	A	B	C	D	F	Insert size	lbs
MTANR/L082A	0.500	0.500	4.00	0.875	0.500	TNM..22..	0.155
MTANR/L123B	0.750	0.750	4.50	1.060	0.750	TNM..33..	0.880
MTANR/L163D	1.000	1.000	6.00	1.060	1.000	TNM..33..	1.540
MTANR/L164D	1.000	1.000	6.00	1.220	1.000	TNM..43..	1.540
MTANR/L205D	1.250	1.250	6.00	1.430	1.250	TNM..54..	2.755
MTANR/L245D	1.500	1.500	6.00	1.430	1.500	TNM..54..	6.615

Reference							Nm ¹	Nm ²
MTANR/L082A	CL-7	XNS-34	5124	-	NL-23	5100	3.5	
MTANR/L123B	CL-20	XNS-48	5103	ITSN-322	NL-34L	5102	3.0	1.4
MTANR/L163D	CL-20	XNS-48	5103	ITSN-322	NL-34L	5102	3.0	1.4
MTANR/L164D	CL-20	XNS-48	5103	ITSN-433	NL-46	5124	3.0	3.5
MTANR/L205D	CL-12	XNS-510	5004	ITSN-533	NL-58	5103	3.5	3.0
MTANR/L245D	CL-12	XNS-510	5004	ITSN-533	NL-58	5103	3.5	3.0

TNM..

Triangular negative inserts. A37-38

Reference	l	T	d
TNM..22..	0.433	0.125	0.250
TNM..33..	0.650	0.187	0.375
TNM..43..	0.866	0.187	0.500
TNM..54..	1.083	0.250	0.625

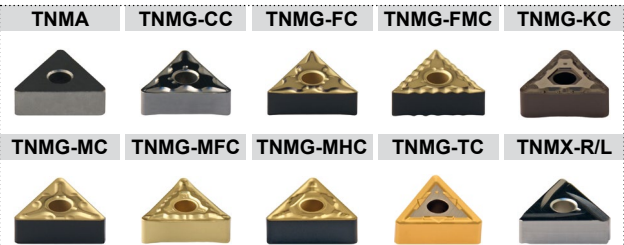
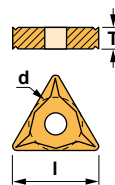





Characteristics:



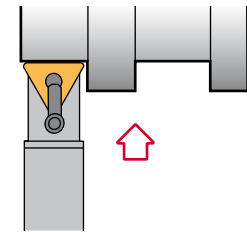
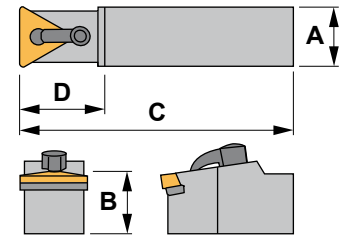



External toolholder for positive inserts.
Toolholder for special applications equipped with triangular negative inserts with strong cutting edges. Profiling toolholder for general applications on all kind of materials.

Axial 6°
Radial 0°



MTCN 90°

Reference	A	B	C	D	Insert size	 lbs
MTCNN443F	0.500	1.000	8.00	1.000	TNM..33..	1.200
MTCNN124B	0.750	0.750	4.50	1.375	TNM..43..	0.800
MTCNN644F	0.750	1.000	8.00	1.375	TNM..43..	1.800
MTCNN664F	0.750	1.500	8.00	1.375	TNM..43..	2.600

Reference							Nm ¹	Nm ²
MTCNN443F	CL-20	XNS-48	5103	ITSN-322	NL-34L	5102	3.0	1.4
MTCNN124B	CL-12	XNS-58	5004	ITSN-433	NL-46	5124	3.5	3.5
MTCNN644F	CL-12	XNS-510	5004	ITSN-433	NL-46	5124	3.5	3.5
MTCNN664F	CL-12	XNS-510	5004	ITSN-433	NL-46	5124	3.5	3.5

TNM..

Triangular negative inserts.  A37-38

Reference	l	T	d
TNM..33..	0.650	0.187	0.375
TNM..43..	0.866	0.187	0.500

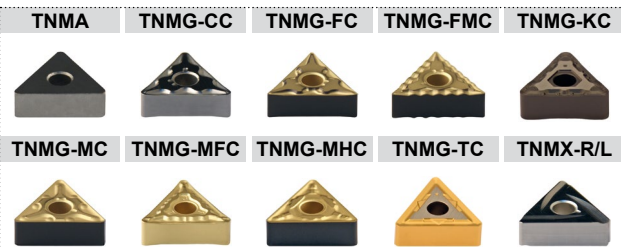
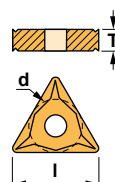

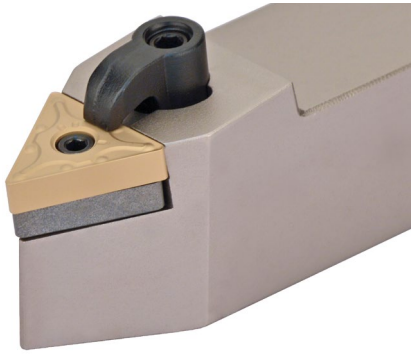

Characteristics:

Copying toolholder equipped with triangular negative double-sided inserts with strong cutting edges.





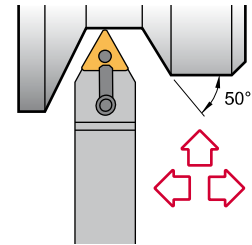
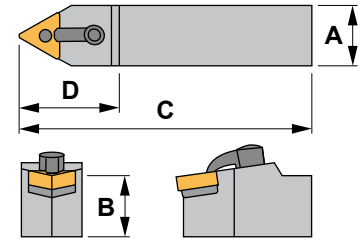

Copying toolholder for general applications, roughing, semi-finishing and finishing.

Axial -8°
Radial 0°



MTENNS 60°

Reference	A	B	C	D	Insert size	
MTENNS082A	0.500	0.500	4.00	1.000	TNM..22..	0.155
MTENNS103B	0.625	0.625	4.50	1.125	TNM..33..	0.440
MTENNS123B	0.750	0.750	4.50	1.300	TNM..33..	0.880
MTENNS163D	1.000	1.000	6.00	1.300	TNM..33..	1.540
MTENNS164D	1.000	1.000	6.00	1.500	TNM..43..	1.540
MTENNS205D	1.250	1.250	6.00	1.732	TNM..54..	2.755
MTENNS246E	1.500	1.500	7.00	2.086	TNM..66..	6.615

Reference							Nm ¹	Nm ²
MTENNS082A	CL-7	XNS-34	5124	-	NL-23	5100	3.5	
MTENNS103B	CL-6	XNS-36	5124	ITSN-322	NL-34L	5102	3.5	1.4
MTENNS123B	CL-20	XNS-48	5103	ITSN-322	NL-34L	5102	3.0	1.4
MTENNS163D	CL-20	XNS-48	5103	ITSN-322	NL-34L	5102	3.0	1.4
MTENNS164D	CL-20	XNS-48	5103	ITSN-433	NL-46	5124	3.0	3.5
MTENNS205D	CL-12	XNS-510	5004	ITSN-533	NL-58	5103	3.5	3.0
MTENNS246E	CL-12	XNS-510	5004	ITSN-637	NL-68L	5135	3.5	4.0

TNM..

Triangular negative inserts.  A37-38

Reference	l	T	d
TNM..22..	0.433	0.125	0.250
TNM..33..	0.650	0.187	0.375
TNM..43..	0.866	0.187	0.500
TNM..54..	1.083	0.250	0.625
TNM..66..	1.300	0.375	0.750

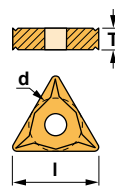

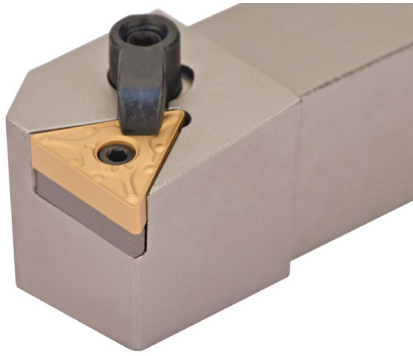

Characteristics:

Face turning toolholder equipped with triangular negative double-sided inserts with strong cutting edges.

For low powered machines and small pieces choose toolholder Ref. STFC (Page: A125).

Axial -6°
Radial -6°

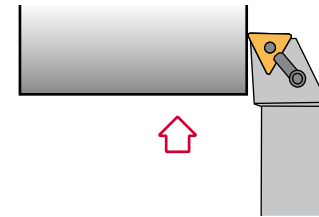
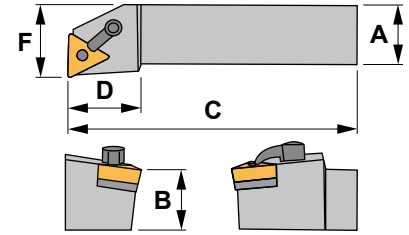

MTFN 90°

Reference	A	B	C	D	F	Insert size	
MTFNR/L123B	0.750	0.750	4.50	1.000	1.000	TNM..33..	0.880
MTFNR/L163D	1.000	1.000	6.00	1.000	1.250	TNM..33..	1.540
MTFNR/L164D	1.000	1.000	6.00	1.000	1.250	TNM..43..	1.540
MTFNR/L204D	1.250	1.250	6.00	1.000	1.500	TNM..43..	2.755
MTFNR/L854D	1.000	1.250	6.00	1.000	1.250	TNM..43..	2.200
MTFNR/L864D	1.000	1.500	6.00	1.000	1.250	TNM..43..	3.100
MTFNR/L165D	1.000	1.000	6.00	1.440	1.250	TNM..54..	1.540
MTFNR/L205D	1.250	1.250	6.00	1.440	1.500	TNM..54..	2.755
MTFNR/L245E	1.500	1.500	7.00	1.440	2.000	TNM..54..	6.615
MTFNR/L855D	1.000	1.250	6.00	1.440	1.250	TNM..54..	2.200
MTFNR/L865D	1.000	1.500	6.00	1.440	1.250	TNM..54..	3.100

Reference							Nm ¹	Nm ²
MTFNR/L123B	CL-20	XNS-48	5103	ITSN-322	NL-34L	5102	3.0	1.4
MTFNR/L163D	CL-20	XNS-48	5103	ITSN-322	NL-34L	5102	3.0	1.4
MTFNR/L164D	CL-20	XNS-48	5103	ITSN-433	NL-46	5124	3.0	3.5
MTFNR/L204D	CL-20	XNS-48	5103	ITSN-433	NL-46	5124	3.0	3.5
MTFNR/L854D	CL-20	XNS-48	5103	ITSN-433	NL-46	5124	3.0	3.5
MTFNR/L864D	CL-20	XNS-48	5103	ITSN-433	NL-46	5124	3.0	3.5
MTFNR/L165D	CL-12	XNS-510	5004	ITSN-533	NL-58	5103	3.5	3.0
MTFNR/L205D	CL-12	XNS-510	5004	ITSN-533	NL-58	5103	3.5	3.0
MTFNR/L245E	CL-12	XNS-510	5004	ITSN-533	NL-58	5103	3.5	3.0
MTFNR/L855D	CL-12	XNS-510	5004	ITSN-533	NL-58	5103	3.5	3.0
MTFNR/L865D	CL-12	XNS-510	5004	ITSN-533	NL-58	5103	3.5	3.0

TNM..

Triangular negative inserts. A37-38

Reference	l	T	d
TNM..33..	0.650	0.187	0.375
TNM..43..	0.866	0.187	0.500
TNM..54..	1.083	0.250	0.625

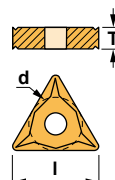

TNMA	TNMG-CC	TNMG-FC	TNMG-FMC	TNMG-KC
TNMG-MC	TNMG-MFC	TNMG-MHC	TNMG-TC	TNMX-R/L

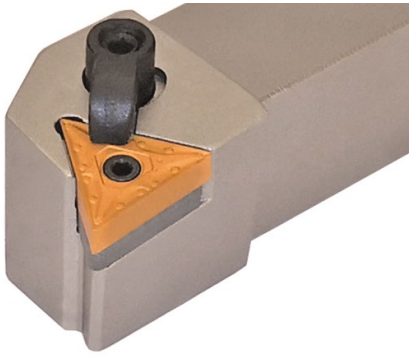

Characteristics:

Profiling toolholder equipped with triangular negative double-sided inserts with strong cutting edges.

For low powered machines and small pieces choose toolholder Ref. STGC (Page: A126).

Axial -6°
Radial -6°

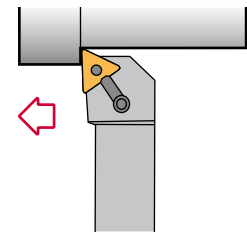
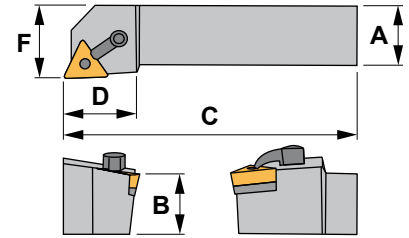

MTGN 90°

Reference	A	B	C	D	F	Insert size	lbs
MTGNR/L082A	0.500	0.500	4.00	0.875	0.625	TNM..22..	0.155
MTGNR/L103B	0.625	0.625	4.50	1.000	0.875	TNM..33..	0.440
MTGNR/L123B	0.750	0.750	4.50	1.060	1.000	TNM..33..	0.880
MTGNR/L163D	1.000	1.000	6.00	1.060	1.250	TNM..33..	1.540
MTGNR/L164C	1.000	1.000	5.00	1.375	1.250	TNM..43..	1.760
MTGNR/L164D	1.000	1.000	6.00	1.220	1.250	TNM..43..	1.540
MTGNR/L204D	1.250	1.250	6.00	1.220	1.250	TNM..43..	2.755
MTGNR/L854D	1.000	1.250	6.00	1.220	1.250	TNM..43..	2.200
MTGNR/L864D	1.000	1.500	6.00	1.220	1.250	TNM..43..	3.100
MTGNR/L165D	1.000	1.000	6.00	1.440	1.250	TNM..54..	1.540
MTGNR/L205D	1.250	1.250	6.00	1.440	1.500	TNM..54..	2.755
MTGNR/L245E	1.500	1.500	7.00	1.440	2.000	TNM..54..	6.615
MTGNR/L855D	1.000	1.250	6.00	1.440	1.250	TNM..54..	2.200
MTGNR/L865D	1.000	1.500	6.00	1.440	1.250	TNM..54..	3.100
MTGNR/L246E	1.500	1.500	7.00	1.500	2.000	TNM..66..	6.615

Reference							Nm ¹	Nm ²
MTGNR/L..2	CL-7	XNS-34	5124	-	NL-23	5100	3.5	
MTGNR/L..3	CL-20	XNS-48	5103	ITSN-322	NL-34L	5102	3.0	1.4
MTGNR/L..4	CL-20	XNS-48	5103	ITSN-433	NL-46	5124	3.0	3.5
MTGNR/L..5	CL-12	XNS-510	5004	ITSN-533	NL-58	5103	3.5	3.0
MTGNR/L..6	CL-12	XNS-510	5004	ITSN-637	NL-68L	5135	3.5	4.0

TNM..

Triangular negative inserts. A37-38

Reference	l	T	d
TNM..22..	0.433	0.125	0.250
TNM..33..	0.650	0.187	0.375
TNM..43..	0.866	0.187	0.500
TNM..54..	1.083	0.250	0.625
TNM..66..	1.300	0.375	0.750

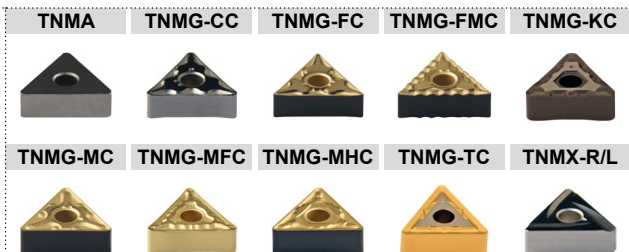
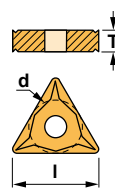

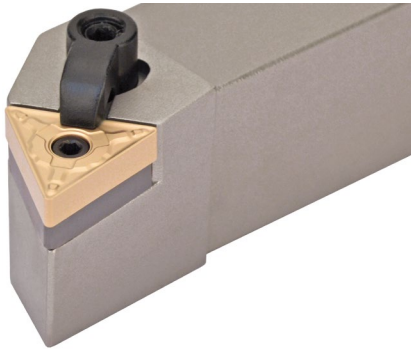

Characteristics:

Multipurpose toolholder equipped with triangular negative double-sided inserts with strong cutting edges. Profiling and copying toolholder for specific applications, roughing, semi-finishing and finishing.

Axial -6°
Radial -6°

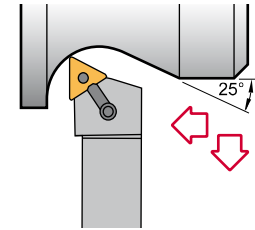
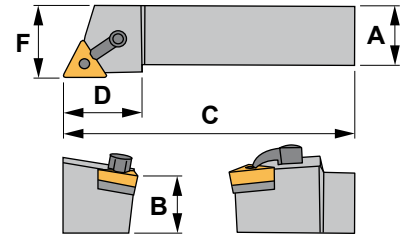

MTJNS 93°

Reference	A	B	C	D	F	Insert size	lbs
MTJNRS/LS123B	0.750	0.750	4.50	1.030	1.000	TNM..33..	0.880
MTJNRS/LS163D	1.000	1.000	6.00	1.030	1.250	TNM..33..	1.540
MTJNRS/LS164D	1.000	1.000	6.00	1.250	1.250	TNM..43..	1.540
MTJNRS/LS204D	1.250	1.250	6.00	1.250	1.500	TNM..43..	2.755
MTJNRS/LS205D	1.250	1.250	6.00	1.440	1.500	TNM..54..	2.755
MTJNRS/LS246E	1.500	1.500	7.00	1.625	2.000	TNM..66..	6.615

Reference							Nm ¹	Nm ²
MTJNRS/LS123B	CL-20	XNS-48	5103	ITSN-322	NL-34L	5102	3.0	1.4
MTJNRS/LS163D	CL-20	XNS-48	5103	ITSN-322	NL-34L	5102	3.0	1.4
MTJNRS/LS164D	CL-20	XNS-48	5103	ITSN-433	NL-46	5124	3.0	3.5
MTJNRS/LS204D	CL-20	XNS-48	5103	ITSN-433	NL-46	5124	3.0	3.5
MTJNRS/LS205D	CL-12	XNS-510	5004	ITSN-533	NL-58	5103	3.5	3.0
MTJNRS/LS246E	CL-12	XNS-510	5004	ITSN-637	NL-68L	5135	3.5	4.0

TNM..

Triangular negative inserts. A37-38

Reference	l	T	d
TNM..33..	0.650	0.187	0.375
TNM..43..	0.866	0.187	0.500
TNM..54..	1.083	0.250	0.625
TNM..66..	1.300	0.375	0.750

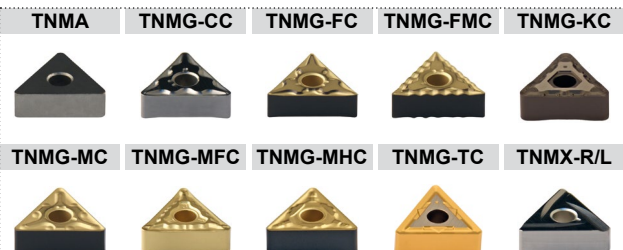
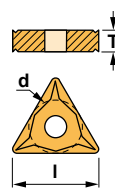



Characteristics:

Toolholder for specific operations equipped with triangular positive inserts and strong cutting edges.





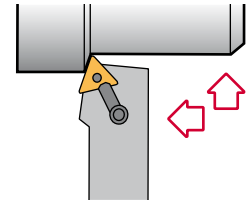
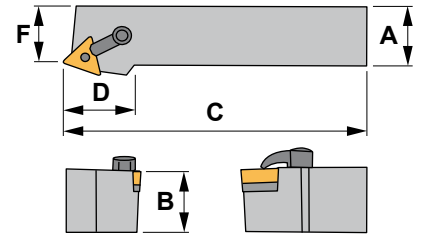

External toolholder for general applications, roughing, semi-finishing and finishing.

Axial -6°
Radial -6°



MTRN 75°

Reference	A	B	C	D	F	Insert size	lbs
MTRNR/L123B	0.750	0.750	4.50	1.160	0.855	TNM..33..	0.880
MTRNR/L163D	1.000	1.000	6.00	1.160	1.105	TNM..33..	1.540
MTRNR/L164D	1.000	1.000	6.00	1.380	1.048	TNM..43..	1.540
MTRNR/L204D	1.250	1.250	6.00	1.380	1.298	TNM..43..	2.755
MTRNR/L205D	1.250	1.250	6.00	1.560	1.252	TNM..54..	2.755
MTRNR/L245E	1.500	1.500	7.00	1.560	1.752	TNM..54..	6.615

Reference							Nm ¹	Nm ²
MTRNR/L123B	CL-20	XNS-48	5103	ITSN-322	NL-34L	5102	3.0	1.4
MTRNR/L163D	CL-20	XNS-48	5103	ITSN-322	NL-34L	5102	3.0	1.4
MTRNR/L164D	CL-20	XNS-48	5103	ITSN-433	NL-46	5124	3.0	3.5
MTRNR/L204D	CL-20	XNS-48	5103	ITSN-433	NL-46	5124	3.0	3.5
MTRNR/L205D	CL-12	XNS-510	5004	ITSN-533	NL-58	5103	3.5	3.0
MTRNR/L245E	CL-12	XNS-510	5004	ITSN-533	NL-58	5103	3.5	3.0

TNM..

Triangular negative inserts.  A37-38

Reference	l	T	d
TNM..33..	0.650	0.187	0.375
TNM..43..	0.866	0.187	0.500
TNM..54..	1.083	0.250	0.625

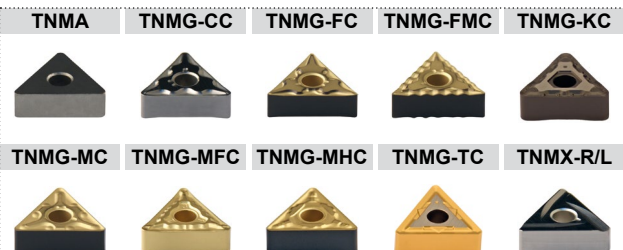
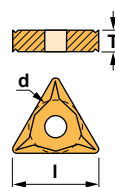



Characteristics:

External turning and profiling toolholder equipped with rhombic negative double-sided insert (angle 35°).

For low powered machines and small pieces choose toolholder Ref. SVJC (Page: A131).

Axial -6°
Radial -6°

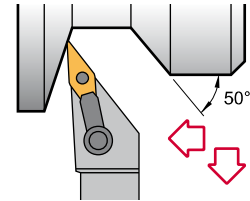
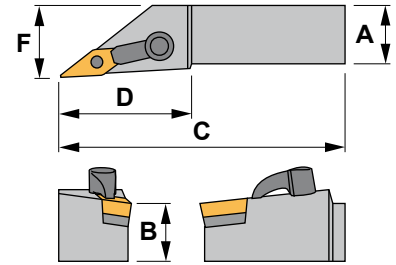

MVJN 93°

Reference	A	B	C	D	F	Insert size	
MVJNR/L123B	0.750	0.750	4.50	1.620	1.000	VN..33..	0.880
MVJNR/L163D	1.000	1.000	6.00	1.620	1.250	VN..33..	1.540
MVJNR/L203D	1.250	1.250	6.00	1.620	1.500	VN..33..	2.755
MVJNR/L164D	1.000	1.000	6.00	1.880	1.250	VN..43..	1.540
MVJNR/L204D	1.250	1.250	6.00	1.880	1.500	VN..43..	2.755
MVJNR/L244E	1.500	1.500	7.00	1.880	2.000	VN..43..	6.615
MVJNR/L854D	1.000	1.250	6.00	1.880	1.250	VN..43..	2.200
MVJNR/L864D	1.000	1.500	6.00	1.880	1.250	VN..43..	3.100

Reference							Nm ¹	Nm ²
MVJNR/L123B	CL-22	XNS-48	5103	IVSN-322	NL-34L	5102	3.0	1.4
MVJNR/L163D	CL-22	XNS-48	5103	IVSN-322	NL-34L	5102	3.0	1.4
MVJNR/L203D	CL-22	XNS-48	5103	IVSN-322	NL-34L	5102	3.0	1.4
MVJNR/L164D	CL-30	XNS-510	5004	IVSN-432	NL-46	5124	3.5	3.5
MVJNR/L204D	CL-30	XNS-510	5004	IVSN-432	NL-46	5124	3.5	3.5
MVJNR/L244E	CL-30	XNS-510	5004	IVSN-432	NL-46	5124	3.5	3.5
MVJNR/L854D	CL-30	XNS-510	5004	IVSN-432	NL-46	5124	3.5	3.5
MVJNR/L864D	CL-30	XNS-510	5004	IVSN-432	NL-46	5124	3.5	3.5

VN..

35° rhombic negative inserts.  A41

Reference	l	T	d
VN..33..	0.650	0.187	0.375
VN..43..	0.866	0.187	0.500

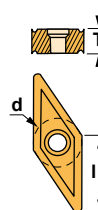

VNGP



VNMG



VNMG-TC









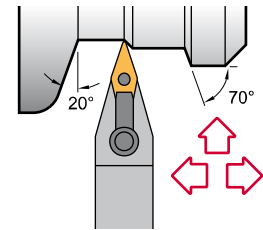
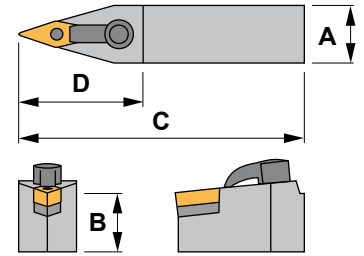

Characteristics:
 Profiling toolholder equipped with rhombic negative double-sided insert (angle 35°).
 For low powered machines and small pieces choose toolholder Ref. SVVC (Page: 133).

Axial 6°
 Radial 0°



MVVN 72°30'

Reference	A	B	C	D	Insert size	
MVVNN123B	0.750	0.750	4.50	1.620	VN..33..	0.880
MVVNN163D	1.000	1.000	6.00	1.620	VN..33..	1.540
MVVNN203D	1.250	1.250	6.00	1.620	VN..33..	2.755
MVVNN243E	1.500	1.500	7.00	1.620	VN..33..	6.615
MVVNN164D	1.000	1.000	6.00	2.060	VN..43..	1.540
MVVNN204D	1.250	1.250	6.00	2.060	VN..43..	2.755
MVVNN244E	1.500	1.500	7.00	2.060	VN..43..	6.615

Reference							Nm ¹	Nm ²
MVVNN123B	CL-22	XNS-48	5103	IVSN-322	NL-34L	5102	3.0	1.4
MVVNN163D	CL-22	XNS-48	5103	IVSN-322	NL-34L	5102	3.0	1.4
MVVNN203D	CL-22	XNS-48	5103	IVSN-322	NL-34L	5102	3.0	1.4
MVVNN243E	CL-22	XNS-48	5103	IVSN-322	NL-34L	5102	3.0	1.4
MVVNN164D	CL-30	XNS-510	5004	IVSN-432	NL-46	5124	3.5	3.5
MVVNN204D	CL-30	XNS-510	5004	IVSN-432	NL-46	5124	3.5	3.5
MVVNN244E	CL-30	XNS-510	5004	IVSN-432	NL-46	5124	3.5	3.5

VN..

35° rhombic negative inserts.  A41

Reference	l	T	d
VN..33..	0.650	0.187	0.375
VN..43..	0.866	0.187	0.500

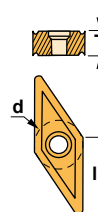

VNGP



VNMG



VNMG-TC



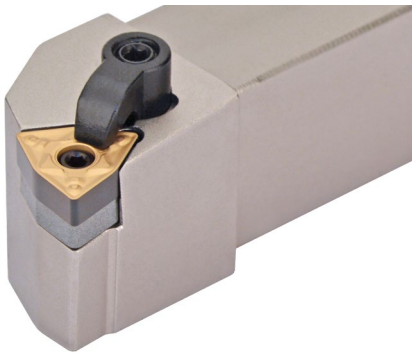

Characteristics:





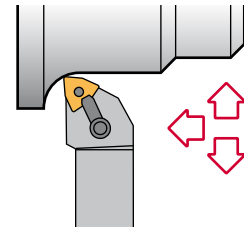
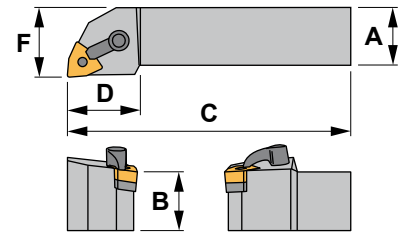

Multipurpose toolholder equipped with trigon negative double-sided insert (angle 80°). External profiling toolholder for general applications, roughing, semi-finishing and finishing.

Axial -5.5°
Radial -6.5°



MWLN 95°

Reference	A	B	C	D	F	Insert size	
MWLN/L123B	0.750	0.750	4.50	1.000	1.000	WNMG33..	0.880
MWLN/L163D	1.000	1.000	6.00	1.000	1.250	WNMG33..	1.540
MWLN/L124B	0.750	0.750	4.50	1.070	1.000	WNMG43..	0.880
MWLN/L164D	1.000	1.000	6.00	1.070	1.250	WNMG43..	1.540
MWLN/L204D	1.250	1.250	6.00	1.070	1.500	WNMG43..	2.755
MWLN/L244E	1.500	1.500	7.00	1.070	2.000	WNMG43..	6.615

Reference							Nm ¹	Nm ²
MWLN/L123B	CL-6	XNS-36	5124	IWSN-322	NL-34L	5102	3.5	1.4
MWLN/L163D	CL-6	XNS-36	5124	IWSN-322	NL-34L	5102	3.5	1.4
MWLN/L124B	CL-20	XNS-48	5103	IWSN-433	NL-46	5124	3.0	3.0
MWLN/L164D	CL-20	XNS-48	5103	IWSN-433	NL-46	5124	3.0	3.5
MWLN/L204D	CL-20	XNS-48	5103	IWSN-433	NL-46	5124	3.0	3.5
MWLN/L244E	CL-20	XNS-48	5103	IWSN-433	NL-46	5124	3.0	3.5

WNMG

80° trigon negative inserts.  A42-43

Reference	l	T	d
WNMG33..	0.254	0.187	0.375
WNMG43..	0.320	0.187	0.500

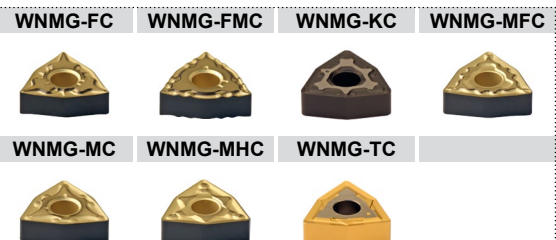
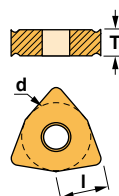

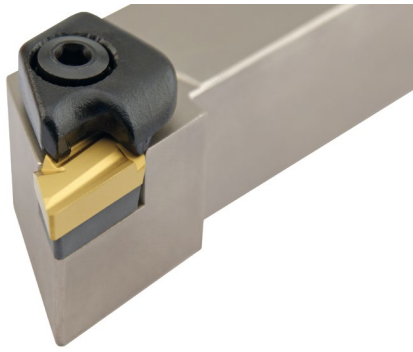

Characteristics:
 Toolholder for turning and profiling operations
 equipped with KNUX negative insert.
 For semi-finishing and finishing operations.

Axial 0°
 Radial -6°

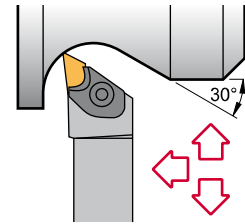
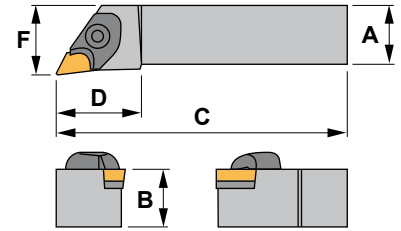

CKJN 93°

Reference	A	B	C	D	F	Insert size	lbs
CKJNR/L123B	0.750	0.750	5.00	1.340	1.000	KNUX1604..	0.858
CKJNR/L163D	1.000	1.000	6.00	1.340	1.250	KNUX1604..	1.540
CKJNR/L203E	1.250	1.250	7.00	1.340	1.500	KNUX1604..	2.200

Reference								Nm
CKJNR123B	2316	1614	5004	4295	4203	3226	4012	3.5
CKJNR163D	2316	1614	5004	4295	4204	3226	4012	3.5
CKJNR203E	2316	1614	5004	4295	4204	3226	4012	3.5
CKJNL123B	2326	1614	5004	4295	4203	3236	4012	3.5
CKJNL163D	2326	1614	5004	4295	4204	3236	4012	3.5
CKJNL203E	2326	1614	5004	4295	4204	3236	4012	3.5

KNUX

KNUX negative insert. A30

Reference	l	T	d
KNUX1604..	0.630	0.187	0.375

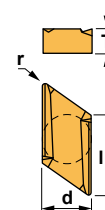

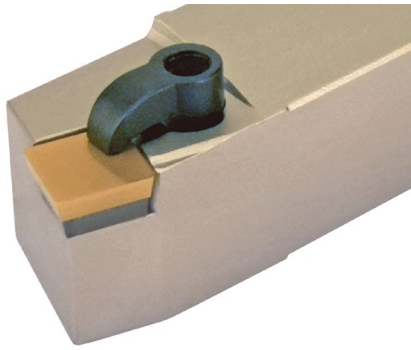
**Characteristics:**

Toolholder for external turning applications equipped with square positive inserts.
For all kind of materials. The workpiece should be stable.

Axial 1.50°
Radial 5.75°

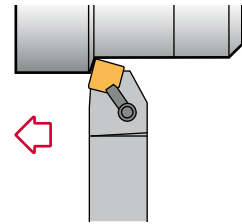
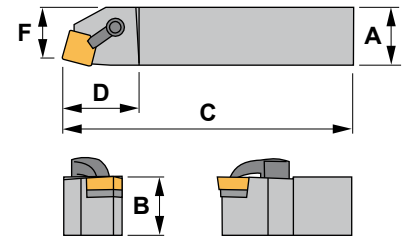

CSBP 75°

Reference	A	B	C	D	F	Insert size	lbs
CSBPR/L103	0.625	0.625	4.50	0.906	0.531	SP..32..	0.440
CSBPR/L123B	0.750	0.750	4.50	0.906	0.656	SP..32..	0.880
CSBPR/L124B	0.750	0.750	4.50	1.187	0.625	SP..42..	0.880
CSBPR/L164D	1.000	1.000	6.00	1.187	0.875	SP..42..	1.540

Reference						Nm
CSBPR/L103	CL-6	XNS-36	5124	3109	4002	3.5
CSBPR/L123B	CL-6	XNS-36	5124	3109	4002	3.5
CSBPR/L124B	CL-20	XNS-47	5103	3112	4002	3.0
CSBPR/L164D	CL-20	XNS-48	5103	3112	4002	3.0

SP..

Square positive inserts with 11° clearance. A35

Reference

Reference	l	T	d
SP..32..	0.375	0.125	0.375
SP..42..	0.500	0.125	0.500

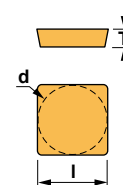
**SPMR****SPUN**

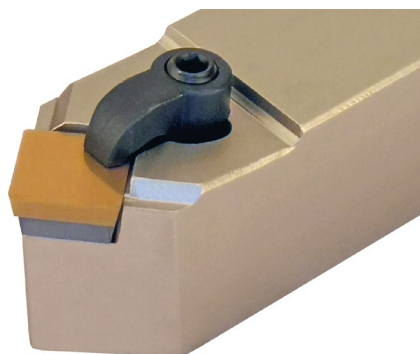





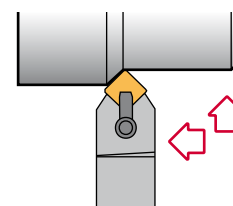
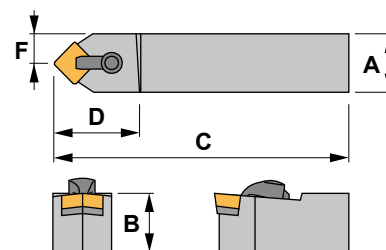

Characteristics:
 Toolholder for external turning applications equipped with square positive inserts.
 For interrupted cut choose toolholder Ref. MSDN (Page: A86).

Axial 4.25°
 Radial 4.25°



CSDP 45°

Reference	A	B	C	D	F	Insert size	
CSDPN083	0.500	0.500	3.50	1.000	0.250	SP..32..	0.155
CSDPN103	0.625	0.625	4.50	1.000	0.312	SP..32..	0.440
CSDPN123B	0.750	0.750	4.50	1.000	0.375	SP..32..	0.880
CSDPN124B	0.750	0.750	4.50	1.312	0.375	SP..42..	0.880
CSDPN164D	1.000	1.000	6.00	1.312	0.500	SP..42..	1.540

Reference						Nm
CSDPN083	CL-7	XNS-34	5124	3109	4002	3.5
CSDPN103	CL-6	XNS-36	5124	3109	4002	3.5
CSDPN123B	CL-6	XNS-36	5124	3109	4002	3.5
CSDPN124B	CL-20	XNS-47	5103	3112	4002	3.0
CSDPN164D	CL-20	XNS-48	5103	3112	4002	3.0

SP..

Square positive inserts with 11° clearance.  A35

Reference

Reference	l	T	d
SP..32..	0.375	0.125	0.375
SP..42..	0.500	0.125	0.500

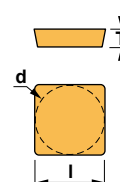

SPMR



SPUN



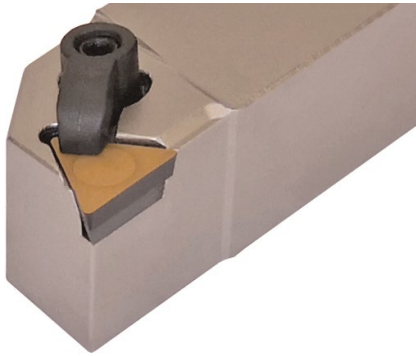



Characteristics:



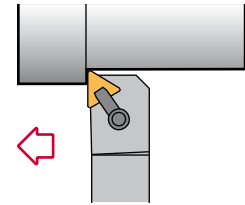
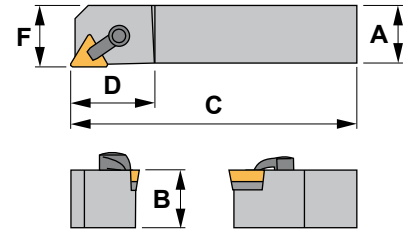

Toolholder for external turning applications equipped with triangular positive inserts. For all kind of materials. The workpiece should be stable.







Axial 6°
Radial 0°



CTAP 90°

Reference	A	B	C	D	F	Insert size	 lbs
CTAPR/L082	0.500	0.500	3.50	0.843	0.515	TP..22..	0.155
CTAPR/L102	0.625	0.625	4.50	0.843	0.641	TP..22..	0.440
CTAPR/L123B	0.750	0.750	4.50	1.062	0.756	TP..32..	0.880
CTAPR/L163D	1.000	1.000	6.00	1.062	1.016	TP..32..	1.540

Reference						Nm
CTAPR/L082	CL-7	XNS-34	5124	-	-	3.5
CTAPR/L102	CL-7	XNS-34	5124	-	-	3.5
CTAPR/L123B	CL-20	XNS-47	5103	3116	4002	3.0
CTAPR/L163D	CL-20	XNS-48	5103	3116	4002	3.0

TP..				Triangular positive inserts with 11° clearance.  A39		
Reference	l	T	d			
TP..22..	0.433	0.125	0.250			
TP..32..	0.650	0.125	0.375			

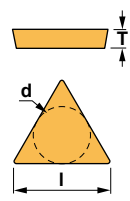





Characteristics:



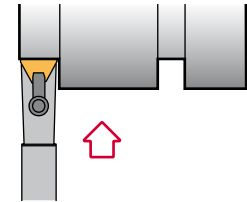
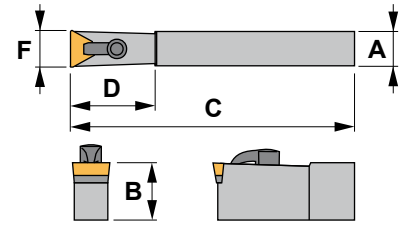

Toolholder for external turning applications equipped with triangular positive inserts. For all kind of materials. The workpiece should be stable.

Axial 6°
Radial 0°



CTCO 90°

Reference	A	B	C	D	F	Insert size	 lbs
CTCON083	0.500	0.500	3.50	1.016	0.627	TP..32..	0.155
CTCON443	0.500	1.000	8.00	1.016	0.627	TP..32..	0.310
CTCON124	0.750	0.750	4.50	1.375	0.843	TP..43..	0.880
CTCON644	0.750	1.000	8.00	1.375	0.843	TP..43..	1.200

Reference						Nm
CTCON083	CL-7	XNS-34	5124	3116	4002	3.5
CTCON443	CL-22	XNS-48	5103	3116	4002	3.0
CTCON124	CL-22	XNS-47	5004	3122	4012	3.5
CTCON644	CL-22	XNS-47	5004	3122	4012	3.5

TP..

Triangular positive inserts with 11° clearance.  A39

Reference	l	T	d
TP..32..	0.650	0.125	0.375
TP..43..	0.866	0.187	0.500

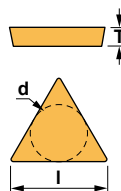

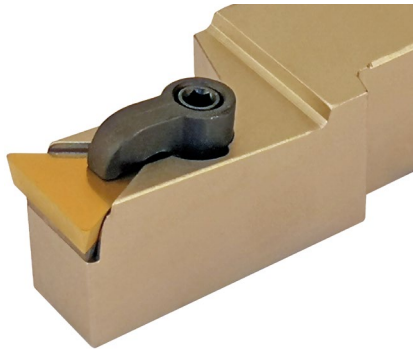
**Characteristics:**

Toolholder for face turning and grooving applications equipped with triangular positive inserts.

For all kind of materials. The workpiece should be stable.

Axial 6°
Radial 0°

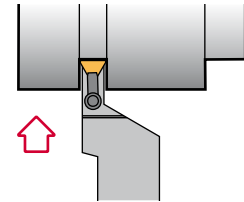
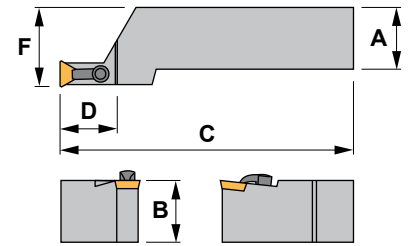

CTCP 90°

Reference	A	B	C	D	F	Insert size	
CTCPR/L123B	0.750	0.750	4.50	1.125	1.000	TP..32..	0.880
CTCPR/L164D	1.000	1.000	6.00	1.375	1.250	TP..43..	1.540
CTCPR/L204D	1.250	1.250	6.00	1.375	1.500	TP..43..	2.755

Reference						Nm
CTCPR/L123B	CL-22	XNS-47	5103	3116	4002	3.0
CTCPR/L164D	CL-12	XNS-510	5004	3122	4012	3.5
CTCPR/L204D	CL-12	XNS-510	5004	3122	4012	3.5

TP..

Triangular positive inserts with 11° clearance.  A39

Reference	l	T	d
TP..32..	0.650	0.125	0.375
TP..43..	0.866	0.187	0.500

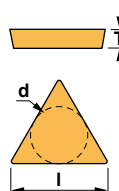

TPMN



TPMR



TPUN



TPUX-R



TPUX-L



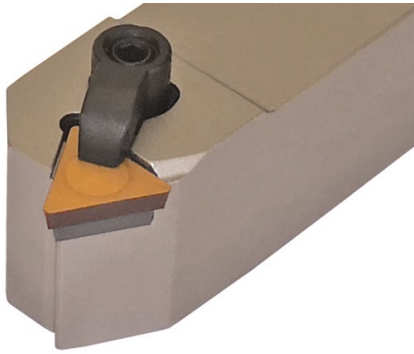

Characteristics:

Toolholder for external turning applications equipped with triangular positive inserts. For all kind of materials. The workpiece should be stable.

Axial 0°
Radial -1°

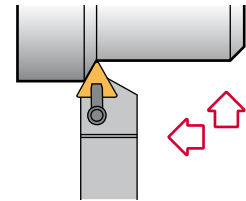
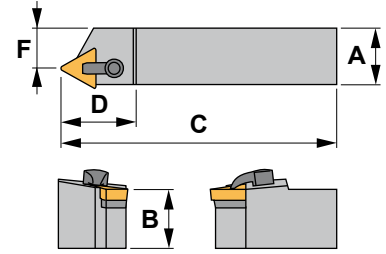

CTEP 60°

Reference	A	B	C	D	F	Insert size	lbs
CTEPR/L082	0.500	0.500	3.50	0.875	0.281	TP..22..	0.155
CTEPR/L102	0.625	0.625	4.50	0.875	0.406	TP..22..	0.440
CTEPR/L123B	0.750	0.750	4.50	1.250	0.437	TP..32..	0.880
CTEPR/L163D	1.000	1.000	6.00	1.250	0.719	TP..32..	1.540

Reference						Nm
CTEPR/L082	CL-7	XNS-34	5124	-	-	3.5
CTEPR/L102	CL-7	XNS-34	5124	-	-	3.5
CTEPR/L123B	CL-20	XNS-47	5103	3116	4002	3.0
CTEPR/L163D	CL-20	XNS-48	5103	3116	4002	3.0

TP..

Triangular positive inserts with 11° clearance. A39

Reference	l	T	d
TP..22..	0.433	0.125	0.250
TP..32..	0.650	0.125	0.375

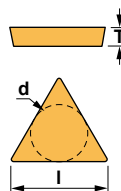

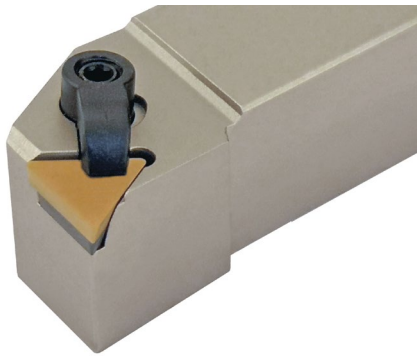



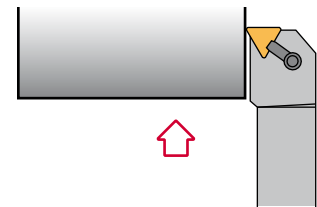
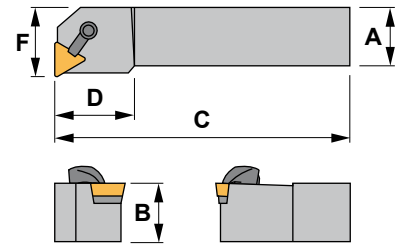

Characteristics:
 Toolholder for face turning applications equipped with triangular positive inserts.
 For interrupted cut choose toolholder Ref. MTFN (Page: A93).







Axial 6°
 Radial 0°



CTFP 90°

Reference	A	B	C	D	F	Insert size	
CTFPR/L103	0.625	0.625	4.50	1.000	0.875	TP..32..	0.440
CTFPR/L123B	0.750	0.750	4.50	1.000	1.000	TP..32..	0.880
CTFPR/L163D	1.000	1.000	6.00	1.000	1.250	TP..32..	1.540

Reference						Nm
CTFPR/L103	CL-20	XNS-48	5103	-	-	3.0
CTFPR/L123B	CL-20	XNS-47	5103	3116	4002	3.0
CTFPR/L163D	CL-20	XNS-48	5103	3116	4002	3.0

TP..				Triangular positive inserts with 11° clearance.  A39		
Reference	l	T	d			
TP..32..	0.650	0.125	0.375			

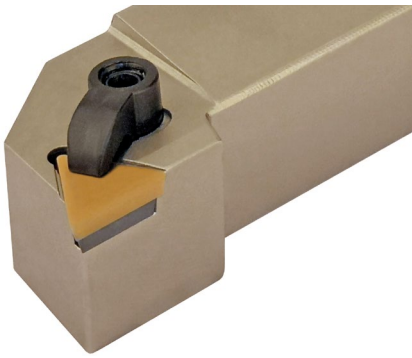





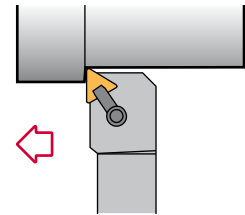
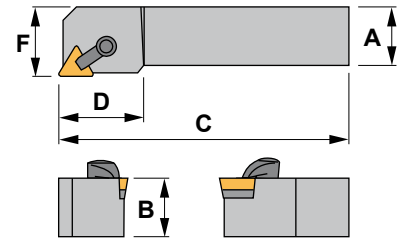

Characteristics:
 Toolholder for external turning applications equipped with triangular positive inserts.
 For interrupted cut choose toolholder Ref. MTGN (Page: A94).

Axial 0°
 Radial 6°



CTGP 90°

Reference	A	B	C	D	F	Insert size	 lbs
CTGPR/L102	0.625	0.625	4.50	1.062	0.875	TP..22..	0.440
CTGPR/L103	0.625	0.625	4.50	1.062	0.875	TP..32..	0.440
CTGPR/L123B	0.750	0.750	4.50	1.062	1.000	TP..32..	0.880
CTGPR/L163D	1.000	1.000	6.00	1.250	1.250	TP..32..	1.540

Reference						Nm
CTGPR/L102	CL-7	XNS-34	5124	-	-	3.5
CTGPR/L103	CL-20	XNS-47	5103	3116	4002	3.0
CTGPR/L123B	CL-20	XNS-47	5103	3116	4002	3.0
CTGPR/L163D	CL-20	XNS-48	5103	3116	4002	3.0

TP..

Triangular positive inserts with 11° clearance.  A39

Reference	l	T	d
TP..22..	0.433	0.125	0.250
TP..32..	0.650	0.125	0.375

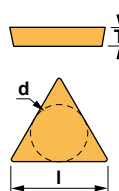

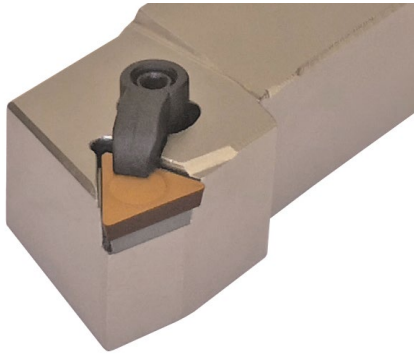



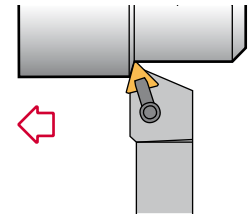
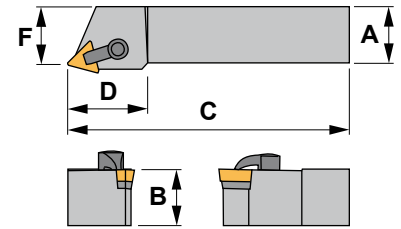

Characteristics:
 Toolholder for external turning applications equipped with triangular positive inserts.
 For interrupted cut choose toolholder Ref. MTRN (Page: A96).







Axial 0°
 Radial 6°



CTRP 75°

Reference	A	B	C	D	F	Insert size	
CTRPR/L102	0.625	0.625	4.50	0.937	0.776	TP..22..	0.440
CTRPR/L123B	0.750	0.750	4.50	1.125	0.855	TP..32..	0.880
CTRPR/L163D	1.000	1.000	6.00	1.125	1.105	TP..32..	1.540

Reference						Nm
CTRPR/L102	CL-6	XNS-36	5124	-	-	3.5
CTRPR/L123B	CL-20	XNS-47	5103	3116	4002	3.0
CTRPR/L163D	CL-20	XNS-48	5103	3116	4002	3.0

TP..				Triangular positive inserts with 11° clearance.  A39		
Reference	l	T	d			
TP..22..	0.433	0.125	0.250			
TP..32..	0.650	0.125	0.375			

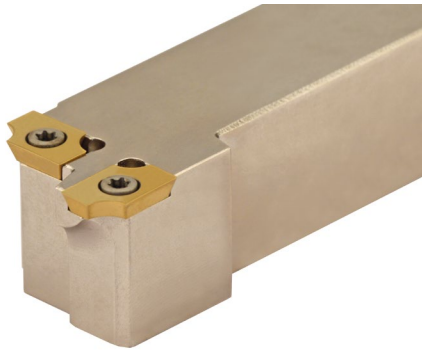

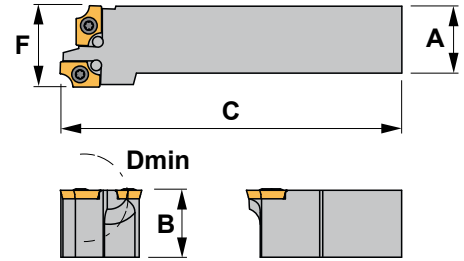
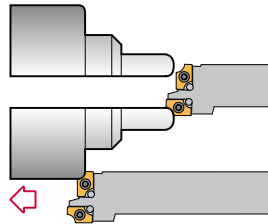

Characteristics:
Toolholder turning convex radius on internal and external diameters in manuals machines.





SAGD 90°

Reference	A	B	C	F	Dmin	Insert size	lbs
SAGDR103H15	0.625	0.625	4.00	1.181	0.787	ADMW1503..	0.575
SAGDR123K15	0.750	0.750	4.50	1.181	0.787	ADMW1503..	0.995
SAGDR163M15	1.000	1.000	6.00	1.181	0.787	ADMW1503..	1.435

Reference			Nm
SAGDR103H15		1240	5515
SAGDR123K15		1240	5515
SAGDR163M15		1240	5515

SET SAGD 90°







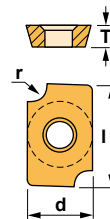

Reference	A	B	C	F	Dmin		
SET-SAGDR103H15	0.625	0.625	4.00	1.181	0.787	1240	5515
SET-SAGDR123K15	0.750	0.750	4.50	1.181	0.787	1240	5515
SET-SAGDR163M15	1.000	1.000	6.00	1.181	0.787	1240	5515

ADMW-R

Parallelogram positive inserts with 15° clearance.  G07

Reference	l	T	d	r
ADMW1503R0.031	0.590	0.125	0.375	1/32
ADMW1503R0.046	0.590	0.125	0.375	3/64
ADMW1503R0.062	0.590	0.125	0.375	1/16
ADMW1503R0.078	0.590	0.125	0.375	5/64
ADMW1503R0.093	0.590	0.125	0.375	3/32
ADMW1503R0.109	0.590	0.125	0.375	7/64
ADMW1503R0.125	0.590	0.125	0.375	1/8
ADMW1503R0.156	0.590	0.125	0.375	5/32
ADMW1503R0.171	0.590	0.125	0.375	11/64
ADMW1503R0.187	0.590	0.125	0.375	3/16





Characteristics:
 Toolholder for external turning applications equipped with rhombic positive inserts (angle 80°).
 For all kind of materials. The workpiece should be stable.

Axial 0°
 Radial 0°

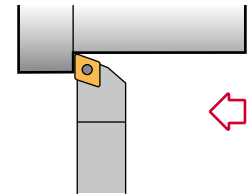
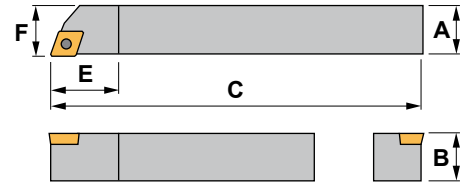

SCAC 90° Automatic lathes

Reference	A	B	C	E	F	Insert size	
SCACR/L4.5D	0.281	0.281	6.00	0.440	0.281	CC..21.5..	0.133
SCACR/L052D	0.312	0.312	6.00	0.440	0.312	CC..21.5..	0.154
SCACR/L062D	0.375	0.375	6.00	0.440	0.375	CC..21.5..	0.242
SCACR/L083D	0.500	0.500	6.00	0.500	0.500	CC..32.5..	0.330
SCACR/L103D	0.625	0.625	6.00	0.625	0.625	CC..32.5..	0.616

Reference			Nm
SCACR/L4.5D	1225	5507	0.9
SCACR/L052D	1225	5507	0.9
SCACR/L062D	1225	5507	0.9
SCACR/L083D	1240	5515	3.0
SCACR/L103D	1240	5515	3.0

CC.. 80° rhombic positive inserts with 7° clearance. A23

Reference	l	T	d
CC..21.5..	0.254	0.093	0.250
CC..32.5..	0.380	0.156	0.375

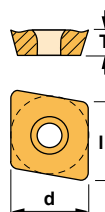

CCGT-AL



CCGT-AP



CCMT



CCMW





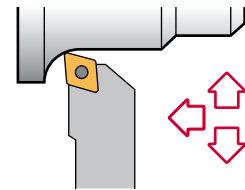
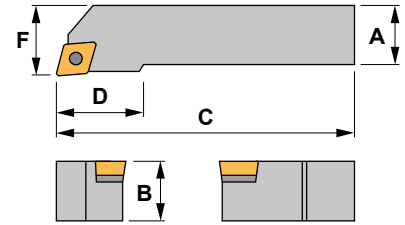

Characteristics:
 Multipurpose toolholder equipped with rhombic positive insert (angle 80°).
 For toolholders with negative inserts see Ref. MCLN (Page: A79).

Axial 0°
 Radial 0°



SCLC 95°

Reference	A	B	C	D	F	Insert size	 lbs
SCLCR/L062	0.375	0.375	2.50	0.390	0.500	CC..21.5..	0.065
SCLCR/L083	0.500	0.500	3.50	0.630	0.625	CC..32.5..	0.155
SCLCR/L103	0.625	0.625	4.00	0.708	0.750	CC..32.5..	0.440
SCLCR/L123B	0.750	0.750	4.50	0.866	1.000	CC..32.5..	0.880
SCLCR/L163D	1.000	1.000	6.00	0.630	1.250	CC..32.5..	1.540
SCLCR/L124B	0.750	0.750	4.50	1.000	1.000	CC..43..	0.880
SCLCR/L164D	1.000	1.000	6.00	1.000	1.250	CC..43..	1.540
SCLCR/L204D	1.250	1.250	6.00	1.000	1.500	CC..43..	2.755

Reference					Nm
SCLCR/L062	1225	5507	-	-	0.9
SCLCR/L083	1240	5515	-	-	3.0
SCLCR/L103	1240	5515	-	-	3.0
SCLCR/L123B	1240	5515	-	-	3.0
SCLCR/L163D	1240	5515	-	-	3.0
SCLCR/L124B	1540	5517	3614	1760	3.0
SCLCR/L164D	1540	5517	3614	1760	3.0
SCLCR/L204D	1540	5517	3614	1760	3.0

CC..

80° rhombic positive inserts with 7° clearance.  A23

Reference	l	T	d
CC..21.5..	0.254	0.093	0.250
CC..32.5..	0.380	0.156	0.375
CC..43..	0.508	0.187	0.500

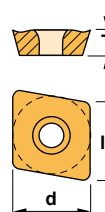

CCGT-AL



CCGT-AP



CCMT



CCMW



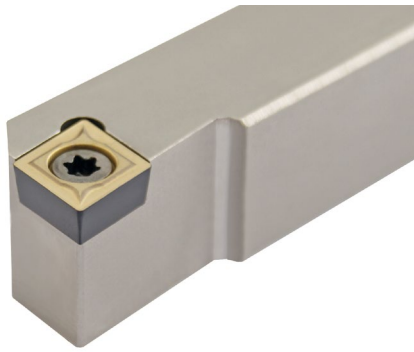

Characteristics:
 Multipurpose toolholder equipped with rhombic positive insert (angle 80°).
 For general applications, roughing, semi-finishing and finishing.

Axial 0°
 Radial 0°

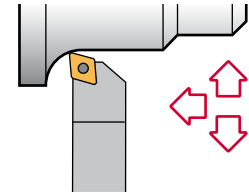
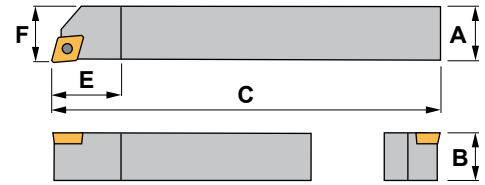

SCLC 95° i Automatic lathes

Reference	A	B	C	E	F	Insert size	lbs
SCLCR/L4.52D	0.281	0.281	6.00	0.500	0.281	CC..21.5..	0.133
SCLCR/L052D	0.312	0.312	6.00	0.500	0.312	CC..21.5..	0.154
SCLCR/L062D	0.375	0.375	6.00	0.500	0.375	CC..21.5..	0.242
SCLCR/L083D	0.500	0.500	6.00	0.620	0.500	CC..32.5..	0.330
SCLCR/L103D	0.625	0.625	6.00	0.787	0.625	CC..32.5..	0.616

Reference			Nm
SCLCR/L4.52D	1225	5507	
SCLCR/L052D	1225	5507	0.9
SCLCR/L062D	1225	5507	0.9
SCLCR/L083D	1240	5515	3.0
SCLCR/L103D	1240	5515	3.0

CC.. i A23

80° rhombic positive inserts with 7° clearance.

Reference	l	T	d
CC..21.5..	0.254	0.093	0.250
CC..32.5..	0.380	0.156	0.375

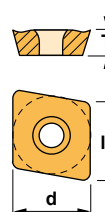

CCGT-AL



CCGT-AP



CCMT



CCMW





Characteristics:
 Multipurpose toolholder equipped with rhombic positive insert (angle 55°).
 For general applications, roughing, semi-finishing and finishing.

Axial 0°
 Radial 0°

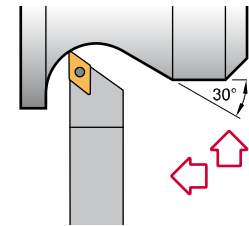
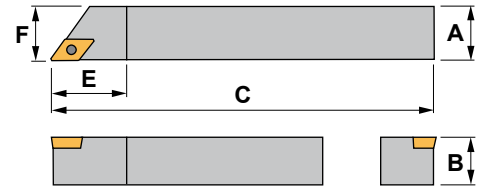

SDAC 90° i Automatic lathes

Reference	A	B	C	E	F	Insert size	lbs
SDACR/L062D	0.375	0.375	6.00	0.625	0.375	DC..21.5..	0.242
SDACR/L082D	0.500	0.500	6.00	0.625	0.500	DC..21.5..	0.330
SDACR/L083D	0.500	0.500	6.00	0.875	0.500	DC..32.5..	0.330
SDACR/L103D	0.625	0.625	6.00	0.875	0.625	DC..32.5..	0.616

Reference			Nm
SDACR/L062D	1225	5507	0.9
SDACR/L082D	1225	5507	0.9
SDACR/L083D	1240	5515	3.0
SDACR/L103D	1240	5515	3.0

DC.. i 55° rhombic positive inserts with 7° clearance. i A27

Reference	l	T	d
DC..21.5..	0.305	0.093	0.250
DC..32.5..	0.456	0.156	0.375

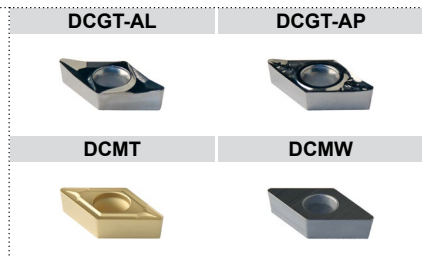





Characteristics:



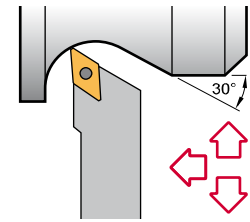
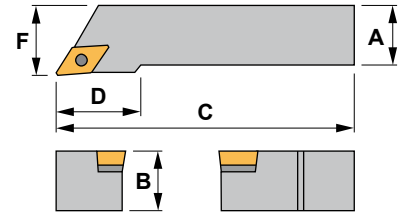

Multipurpose profiling toolholder equipped with rhombic positive insert (angle 55°).
For toolholders with negative inserts see Ref. MDJN (Page: A82).

Axial 0°
Radial 0°



SDJC 93°

Reference	A	B	C	D	F	Insert size	
SDJCR/L062	0.375	0.375	2.50	0.590	0.500	DC..21.5..	0.065
SDJCR/L082	0.500	0.500	3.50	0.670	0.625	DC..21.5..	0.155
SDJCR/L102	0.625	0.625	4.00	0.670	0.750	DC..21.5..	0.440
SDJCR/L122B	0.750	0.750	4.50	0.708	1.000	DC..21.5..	0.880
SDJCR/L123B	0.750	0.750	4.50	1.000	1.000	DC..32.5..	0.880
SDJCR/L163D	1.000	1.000	6.00	1.100	1.250	DC..32.5..	1.540

Reference					Nm
SDJCR/L062	1225	5507	-	-	0.9
SDJCR/L082	1225	5507	-	-	0.9
SDJCR/L102	1225	5507	-	-	0.9
SDJCR/L122B	1225	5507	-	-	0.9
SDJCR/L123B	1335	5516	3714	1750	3.0
SDJCR/L163D	1335	5516	3714	1750	3.0

DC..

55° rhombic positive inserts with 7° clearance.  A27

Reference	l	T	d
DC..21.5..	0.305	0.093	0.250
DC..32.5..	0.456	0.156	0.375

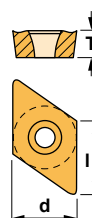

DCGT-AL

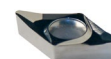

DCGT-AP



DCMT



DCMW

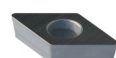

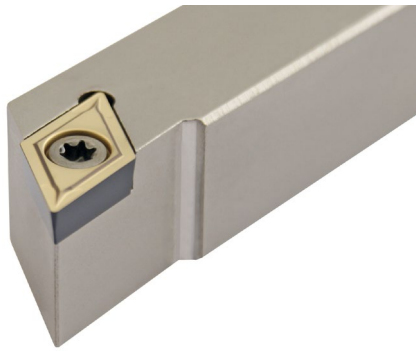

Characteristics:

Multipurpose profiling toolholder equipped with rhombic positive insert (angle 55°).

For general applications, roughing, semi-finishing and finishing.

Axial 0°
Radial 0°

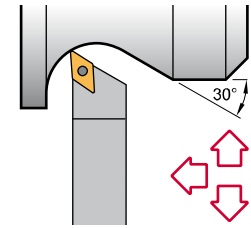
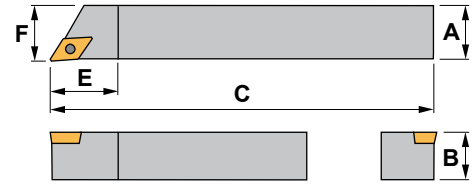

SDJC 93° Automatic lathes

Reference	A	B	C	E	F	Insert size	
SDJCR/L062D	0.375	0.375	6.00	0.625	0.375	DC..21.5..	0.242
SDJCR/L082D	0.500	0.500	6.00	0.625	0.500	DC..21.5..	0.330
SDJCR/L083D	0.500	0.500	6.00	0.750	0.500	DC..32.5..	0.330
SDJCR/L103D	0.625	0.625	6.00	0.750	0.625	DC..32.5..	0.616

Reference			Nm
SDJCR/L062D	1225	5507	0.9
SDJCR/L082D	1225	5507	0.9
SDJCR/L083D	1240	5515	3.0
SDJCR/L103D	1240	5515	3.0

DC.. 55° rhombic positive inserts with 7° clearance. A27

Reference	l	T	d
DC..21.5..	0.305	0.093	0.250
DC..32.5..	0.456	0.156	0.375

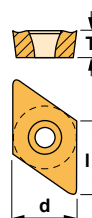

DCGT-AL	DCGT-AP
DCMT	DCMW



Characteristics:
 Multipurpose external turning toolholder equipped with rhombic positive insert (angle 55°).
 For general applications, roughing, semi-finishing and finishing.

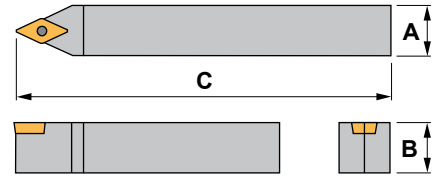

Axial 0°
 Radial 0°

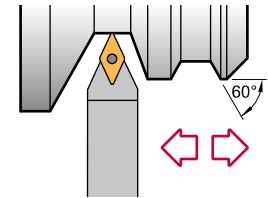

SDNC 62°30' i Automatic lathes

Reference	A	B	C	Insert size	lbs
SDNCN062D	0.375	0.375	6.00	DC..21.5..	0.220
SDNCN082D	0.500	0.500	6.00	DC..21.5..	0.308
SDNCN083D	0.500	0.500	6.00	DC..32.5..	0.308
SDNCN103D	0.625	0.625	6.00	DC..32.5..	0.594

Reference			Nm
SDNCN062D	1225	5507	0.9
SDNCN082D	1225	5507	0.9
SDNCN083D	1240	5515	3.0
SDNCN103D	1240	5515	3.0

DC..

55° rhombic positive inserts with 7° clearance. i A27

Reference	l	T	d
DC..21.5..	0.305	0.093	0.250
DC..32.5..	0.456	0.156	0.375



DCGT-AL

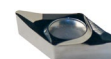

DCGT-AP



DCMT



DCMW

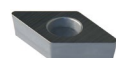

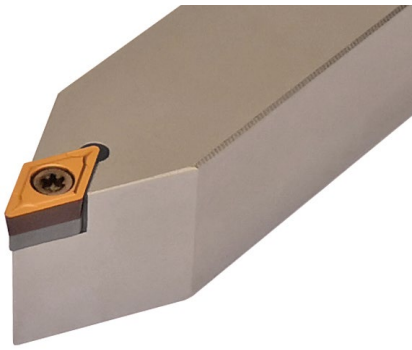



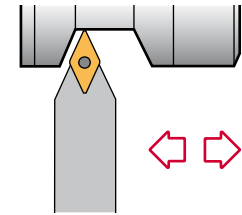
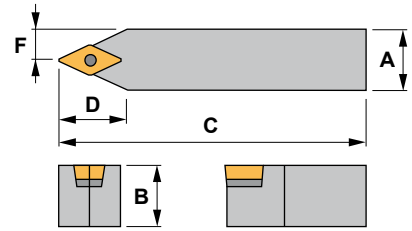

Characteristics:
 External toolholder equipped with rhombic positive insert (angle 55°).
 For interrupted cut and hard materials see Ref. MDPN (Page: A83).

Axial 0°
 Radial 0°



SDPC 62°30'

Reference	A	B	C	D	F	Insert size	lbs
SDPCN062	0.375	0.375	2.50	0.370	0.197	DC..21.5..	0.065
SDPCN082	0.500	0.500	3.50	0.492	0.260	DC..21.5..	0.155
SDPCN103	0.625	0.625	4.00	0.630	0.323	DC..32.5..	0.440
SDPCN123B	0.750	0.750	4.50	0.744	0.382	DC..32.5..	0.880
SDPCN163D	1.000	1.000	6.00	0.984	0.520	DC..32.5..	1.540

Reference					Nm
SDPCN062	1225	5507	-	-	0.9
SDPCN082	1225	5507	-	-	0.9
SDPCN103	1335	5516	3714	1750	3.0
SDPCN123B	1335	5516	3714	1750	3.0
SDPCN163D	1335	5516	3714	1750	3.0

DC.. 55° rhombic positive inserts with 7° clearance.  A27

Reference	l	T	d
DC..21.5..	0.305	0.093	0.250
DC..32.5..	0.456	0.156	0.375

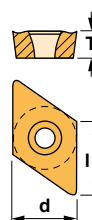

DCGT-AL



DCGT-AP



DCMT



DCMW

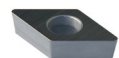

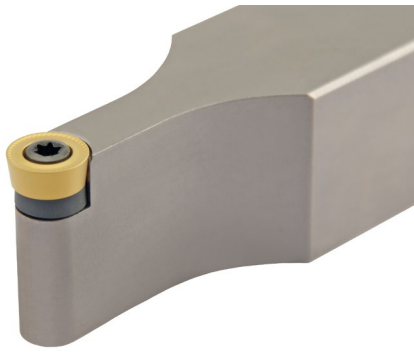



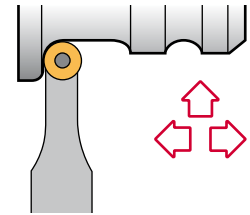
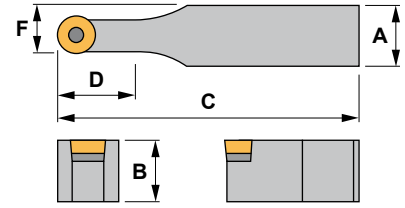

Characteristics:
 Profiling toolholder equipped with round positive insert.
 For semi-finishing and finishing operations on all kind of materials.

Axial 0°
 Radial 0°



SRDC

Reference	A	B	C	D	F	Insert size	
SRDCN082	0.500	0.500	3.50	0.500	0.407	RC..0803M0	0.155
SRDCN103	0.625	0.625	4.00	0.630	0.510	RC..10T3M0	0.440
SRDCN123B	0.750	0.750	4.50	1.000	0.570	RC..10T3M0	0.880
SRDCN164D	1.000	1.000	6.00	1.000	0.736	RC..1204M0	1.540
SRDCN204D	1.250	1.250	6.00	1.000	0.861	RC..1204M0	2.755

Reference					Nm
SRDCN082	1230	5508	-	-	1.2
SRDCN103	1335	5516	3811	1750	3.0
SRDCN123B	1335	5516	3811	1750	3.0
SRDCN164D	1335	5516	3814	1750	3.0
SRDCN204D	1335	5516	3814	1750	3.0

RC..

Round positive inserts with 7° clearance.  A31

Reference	T	d
RC..0803M0	0.125	0.315
RC..10T3M0	0.156	0.394
RC..1204M0	0.187	0.472

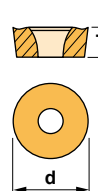

RCGT-AL



RCGT-AP



RCMT



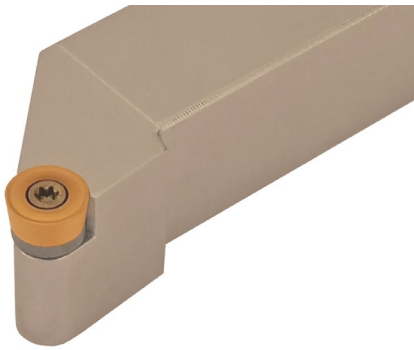

Characteristics:
 External toolholder equipped with round positive insert.
 For semi-finishing and finishing operations on all kind of materials.

Axial 0°
 Radial 0°

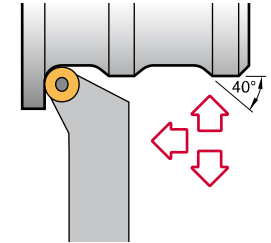
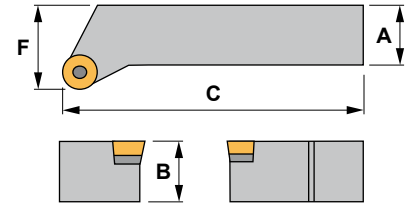

SRGC

Reference	A	B	C	F	Insert size	lbs
SRGCR/L123B	0.750	0.750	4.50	1.000	RC..10T3M0	0.880
SRGCR/L163D	1.000	1.000	6.00	1.250	RC..10T3M0	1.540
SRGCR/L164D	1.000	1.000	6.00	1.250	RC..1204M0	1.540
SRGCR/L854D	1.000	1.250	6.00	1.250	RC..1204M0	2.200
SRGCR/L204D	1.250	1.250	6.00	1.500	RC..1204M0	2.755

Reference					Nm
SRGCR/L123B	1335	5516	3811	1750	3.0
SRGCR/L163D	1335	5516	3811	1750	3.0
SRGCR/L164D	1335	5516	3814	1750	3.0
SRGCR/L854D	1335	5516	3814	1750	3.0
SRGCR/L204D	1335	5516	3814	1750	3.0

RC..

Round positive inserts with 7° clearance. A31

Reference	T	d
RC..10T3M0	0.156	0.394
RC..1204M0	0.187	0.472

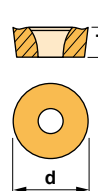

RCGT-AL

RCGT-AP



RCMT



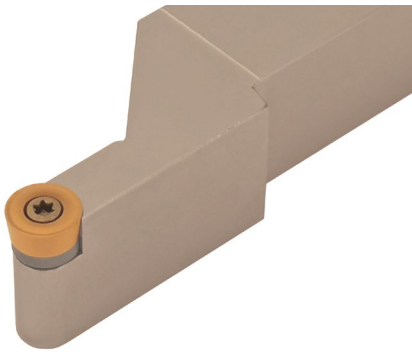

Characteristics:

External toolholder equipped with round positive insert.
For semi-finishing and finishing operations on all kind of materials.

Axial 0°
Radial 0°

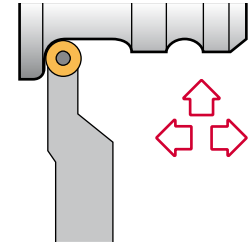
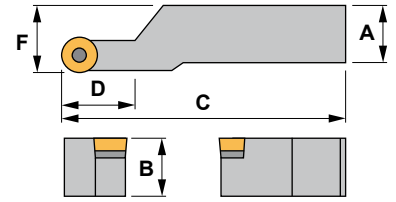

SRSC

Reference	A	B	C	D	F	Insert size	
SRSCR/L163D	1.000	1.000	6.00	0.750	1.250	RC..10T3M0	1.540
SRSCR/L203D	1.250	1.250	6.00	0.750	1.500	RC..10T3M0	2.755
SRSCR/L124B	0.750	0.750	4.50	0.750	1.000	RC..1204M0	0.880
SRSCR/L164D	1.000	1.000	6.00	1.000	1.250	RC..1204M0	1.540
SRSCR/L204D	1.250	1.250	6.00	1.000	1.500	RC..1204M0	2.755

Reference					Nm
SRSCR/L163D	1335	5516	3811	1750	3.0
SRSCR/L203D	1335	5516	3811	1750	3.0
SRSCR/L124B	1335	5516	3814	1750	3.0
SRSCR/L164D	1335	5516	3814	1750	3.0
SRSCR/L204D	1335	5516	3814	1750	3.0

RC..

Round positive inserts with 7° clearance. A31

Reference	T	d
RC..10T3M0	0.156	0.394
RC..1204M0	0.187	0.472

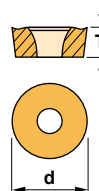

RCGT-AL



RCGT-AP



RCMT



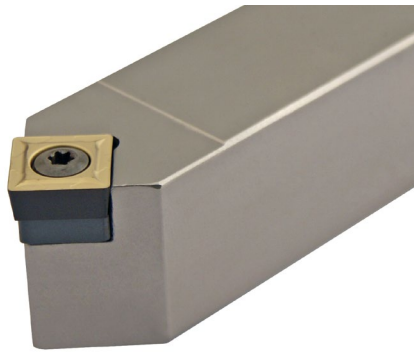

Characteristics:

Toolholder for external turning and chamfering applications equipped with square positive inserts.



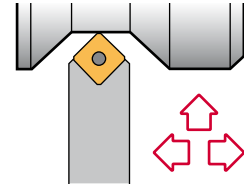
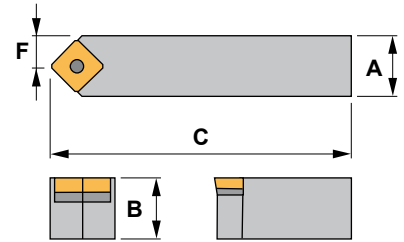

For toolholders with negative inserts see Ref. MSSN (Page: A89).

Axial 0°
Radial 0°



SSDC 45°

Reference	A	B	C	F	Insert size	
SSDCN083	0.500	0.500	3.50	0.263	SC..32.5..	0.155
SSDCN103	0.625	0.625	4.00	0.325	SC..32.5..	0.440
SSDCN124B	0.750	0.750	4.50	0.388	SC..43..	0.880

Reference					Nm
SSDCN083	1240	5515	-	-	3.0
SSDCN103	1240	5515	-	-	3.0
SSDCN124B	1540	5517	3514	1760	3.0

SC..

Square positive inserts with 7° clearance.  A32

Reference	l	T	d
SC..32.5..	0.375	0.156	0.375
SC..43..	0.500	0.187	0.500

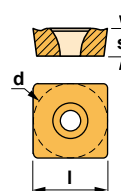

SCGT-AL



SCMT



SCMT-39



SCMW





Characteristics:

Toolholder for external turning and chamfering applications equipped with triangular positive inserts.

For all kind of materials. The workpiece should be stable.

Axial 0°
Radial 0°

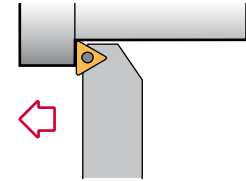
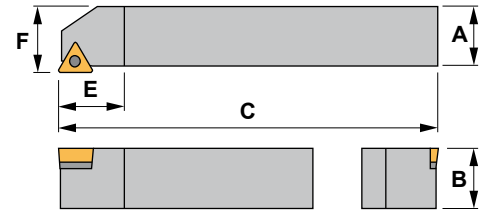

STAC 90° Automatic lathes

Reference	A	B	C	E	F	Insert size	lbs
STACR/L062D	0.375	0.375	6.00	0.625	0.375	TC..21.5..	0.220
STACR/L082D	0.500	0.500	6.00	0.625	0.500	TC..21.5..	0.308
STACR/L102D	0.625	0.625	6.00	0.625	0.625	TC..21.5..	0.616
STACR/L103D	0.625	0.625	6.00	0.750	0.625	TC..32.5..	0.594

Reference			Nm
STACR/L062D	1225	5507	0.9
STACR/L082D	1225	5507	0.9
STACR/L102D	1225	5507	0.9
STACR/L103D	1240	5515	3.0

TC.. Triangular positive inserts with 7° clearance. A36						TCGT-AL	TCMT
Reference	l	T	d				
TC..21.5..	0.433	0.094	0.250				
TC..32.5..	0.650	0.156	0.375				



Characteristics:

Toolholder for external turning and chamfering applications equipped with triangular positive inserts.

For toolholders with negative inserts see Ref. MTRN (Page: A96).

Axial 0°
Radial 0°

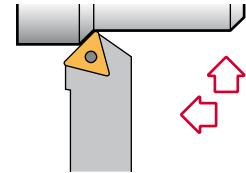
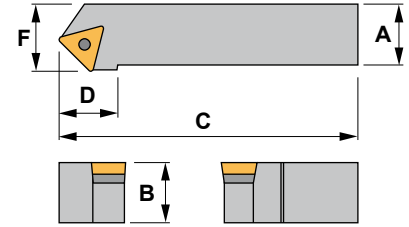

STDC 45°

Reference	A	B	C	D	F	Insert size	lbs
STDCR/L062	0.375	0.375	2.50	0.410	0.433	TC..21.5..	0.065
STDCR/L082	0.500	0.500	3.50	0.570	0.512	TC..21.5..	0.155
STDCR/L103	0.625	0.625	4.00	1.000	0.669	TC..32.5..	0.440
STDCR/L123B	0.750	0.750	4.50	1.000	0.866	TC..32.5..	0.880
STDCR/L163D	1.000	1.000	6.00	1.000	1.063	TC..32.5..	1.540

Reference					Nm
STDCR/L062	1225	5507	-	-	0.9
STDCR/L082	1225	5507	-	-	0.9
STDCR/L103	1335	5516	3414	1750	3.0
STDCR/L123B	1335	5516	3414	1750	3.0
STDCR/L163D	1335	5516	3414	1750	3.0

TC..

Triangular positive inserts with 7° clearance. A36

Reference	l	T	d
TC..21.5..	0.433	0.094	0.250
TC..32.5..	0.650	0.156	0.375

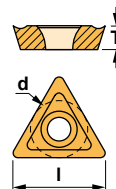

TCGT-AL



TCMT



TCMW







Characteristics:



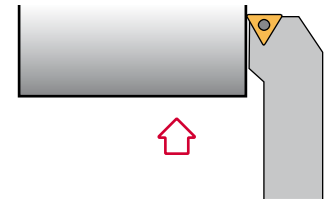
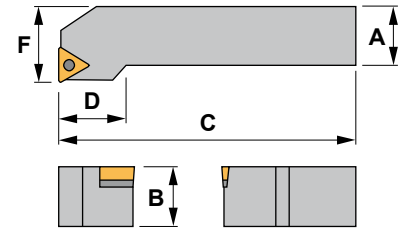

Toolholder for face turning applications equipped with triangular positive inserts. For toolholders with negative inserts see Ref. MTFN (Page: A93).





Axial 0°
Radial 0°

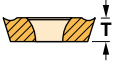
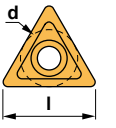

STFC 90°

Reference	A	B	C	D	F	Insert size	 lbs
STFCR/L062	0.375	0.375	2.5	0.400	0.500	TC..21.5..	0.065
STFCR/L082	0.500	0.500	3.5	0.689	0.625	TC..21.5..	0.155
STFCR/L103	0.625	0.625	4.0	1.000	0.750	TC..32.5..	0.440
STFCR/L123B	0.750	0.750	4.5	1.000	1.000	TC..32.5..	0.880
STFCR/L163D	1.000	1.000	6.0	1.000	1.250	TC..32.5..	1.540

Reference					Nm
STFCR/L062	1225	5507	-	-	0.9
STFCR/L082	1225	5507	-	-	0.9
STFCR/L103	1335	5516	3414	1750	3.0
STFCR/L123B	1335	5516	3414	1750	3.0
STFCR/L163D	1335	5516	3414	1750	3.0

TC..				Triangular positive inserts with 7° clearance.  A36		TCGT-AL		TCMT	
Reference	l	T	d						
TC..21.5..	0.433	0.094	0.250						
TC..32.5..	0.650	0.156	0.375						



Characteristics:
 Toolholder for external turning applications equipped with triangular positive inserts.
 For toolholders with negative inserts see Ref. MTGN (Page: A94).

Axial 0°
 Radial 0°

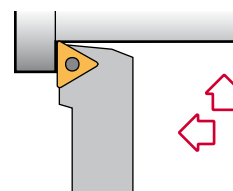
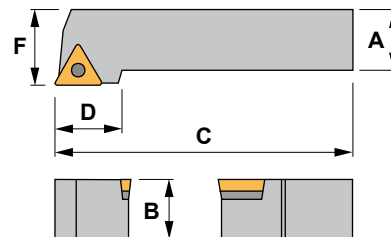

STGC 90°

Reference	A	B	C	D	F	Insert size	
STGCR/L062	0.375	0.375	2.50	0.500	0.500	TC..21.5..	0.065
STGCR/L082	0.500	0.500	3.50	0.560	0.625	TC..21.5..	0.155
STGCR/L103	0.625	0.625	4.00	1.000	0.750	TC..32.5..	0.440
STGCR/L123B	0.750	0.750	4.50	1.000	1.000	TC..32.5..	0.880
STGCR/L163D	1.000	1.000	6.00	1.000	1.250	TC..32.5..	1.540

Reference					Nm
STGCR/L062	1225	5507	-	-	0.9
STGCR/L082	1225	5507	-	-	0.9
STGCR/L103	1335	5516	3414	1750	3.0
STGCR/L123B	1335	5516	3414	1750	3.0
STGCR/L163D	1335	5516	3414	1750	3.0

TC..

Triangular positive inserts with 7° clearance. A36

Reference	l	T	d
TC..21.5..	0.433	0.094	0.250
TC..32.5..	0.650	0.156	0.375

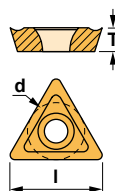

TCGT-AL

TCMT



TCMW





Characteristics:

Toolholder for external and face turning applications equipped with triangular positive inserts.

For all kind of materials. The workpiece should be stable.

Axial 0°
Radial 0°

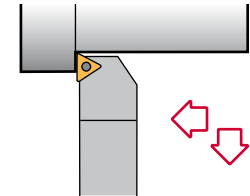
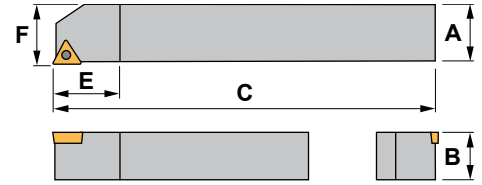

STJC 93°

Automatic lathes

Reference	A	B	C	E	F	Insert size	lbs
STJCR/L062D	0.375	0.375	6.00	0.625	0.375	TC..21.5..	0.242
STJCR/L082D	0.500	0.500	6.00	0.625	0.500	TC..21.5..	0.330
STJCR/L102D	0.625	0.625	6.00	0.625	0.625	TC..21.5..	0.616

Reference			Nm
STJCR/L062D	1225	5507	0.9
STJCR/L082D	1225	5507	0.9
STJCR/L102D	1225	5507	0.9

TC..				Triangular positive inserts with 7° clearance. A36	
Reference	l	T	d		
TC..21.5..	0.433	0.094	0.250		

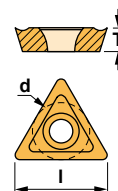



Characteristics:

Toolholder for external turning and chamfering applications equipped with triangular positive inserts.

For toolholders with negative inserts see Ref. MTRN (Page: A96).

Axial 0°
Radial 0°

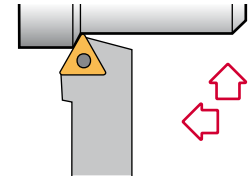
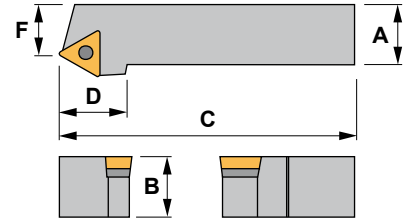

STTC 60°

Reference	A	B	C	D	F	Insert size	lbs
STTCR/L123B	0.750	0.750	4.50	1.000	0.718	TC..32.5..	0.880
STTCR/L163D	1.000	1.000	6.00	1.000	0.860	TC..32.5..	1.540

Reference					Nm
STTCR/L123B	1335	5516	3414	1750	3.0
STTCR/L163D	1335	5516	3414	1750	3.0

TC.. Triangular positive inserts with 7° clearance. A36

Reference	l	T	d
TC..32.5..	0.433	0.094	0.250

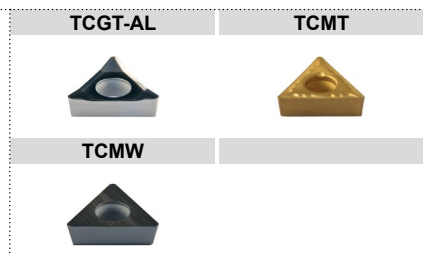
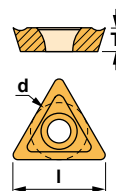



Characteristics:

Multipurpose profiling toolholder equipped with rhombic positive insert (angle 55°).

For general applications, roughing, semi-finishing and finishing.

Axial 0°
Radial 0°

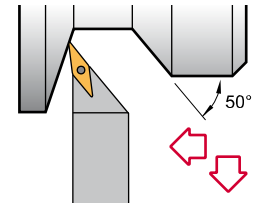
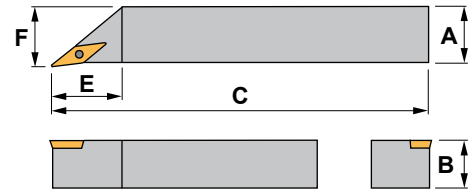

SVAC 90°

i Automatic lathes

Reference	A	B	C	E	F	Insert size	 lbs
SVACR/L062D	0.375	0.375	6.00	0.875	0.375	VC..22..	0.220
SVACR/L082D	0.500	0.500	6.00	0.875	0.500	VC..22..	0.308
SVACR/L103D	0.625	0.625	6.00	1.375	0.625	VC..33..	0.308

Reference			Nm
SVACR/L062D	1225	5507	0.9
SVACR/L082D	1225	5507	0.9
SVACR/L103D	1240	5515	3.0

VC..

35° rhombic positive inserts with 7° clearance. **i** A40

Reference	l	T	d
VC..22..	0.433	0.125	0.250
VC..33..	0.650	0.187	0.375

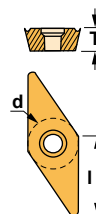

VCGT-AL



VCGT-AP



VCMT



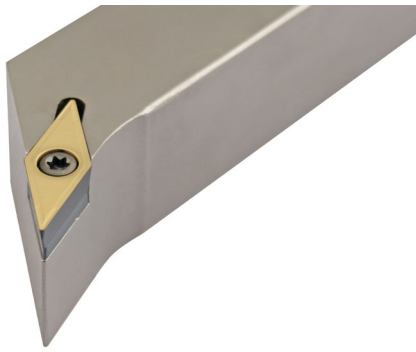

Characteristics:
 Multipurpose profiling toolholder equipped with rhombic positive insert (angle 35°).
 For general applications, semi-finishing and finishing.

Axial 0°
 Radial 0°

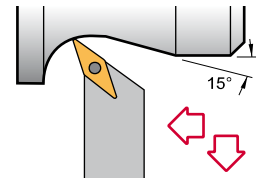
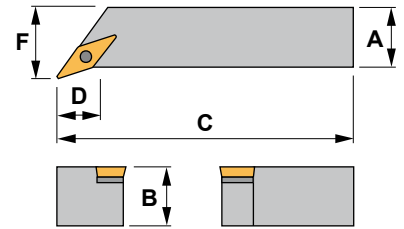

SVHC 107°30'

Reference	A	B	C	D	F	Insert size	lbs
SVHCR/L123B	0.750	0.750	4.50	0.740	1.000	VC..33..	0.880
SVHCR/L163D	1.000	1.000	6.00	0.756	1.250	VC..33..	1.540

Reference					Nm
SVHCR/L123B	1335	5516	3718	1750	3.0
SVHCR/L163D	1335	5516	3718	1750	3.0

VC.. 35° rhombic positive inserts with 7° clearance. A40

Reference	l	T	d
VC..33..	0.650	0.187	0.375

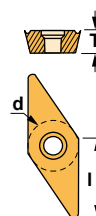

VCGT-AL



VCGT-AP



VCMT



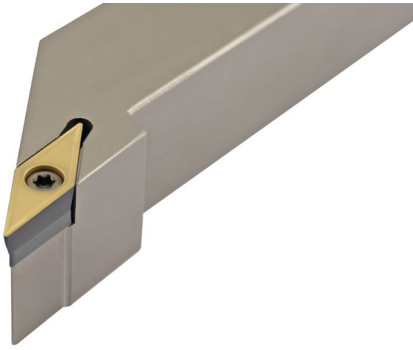



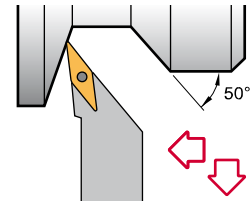
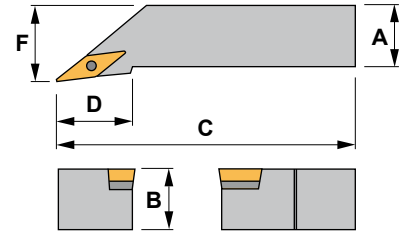

Characteristics:
 Multipurpose profiling toolholder equipped with rhombic positive insert (angle 35°).
 For toolholders with negative inserts see Ref. MVJN (Page: A97).





Axial 0°
 Radial 0°



SVJC 93°

Reference	A	B	C	D	F	Insert size	 lbs
SVJCR/L123B	0.750	0.750	4.50	1.614	1.000	VC..33..	0.880
SVJCR/L163D	1.000	1.000	6.00	1.614	1.250	VC..33..	1.540
SVJCR/L203D	1.250	1.250	6.00	1.614	1.500	VC..33..	2.755

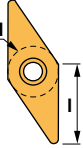
Reference					Nm
SVJCR/L123B	1335	5516	3718	1750	3.0
SVJCR/L163D	1335	5516	3718	1750	3.0
SVJCR/L203D	1335	5516	3718	1750	3.0

VC..				35° rhombic positive inserts with 7° clearance.  A40	
Reference	l	T	d		
VC..33..	0.650	0.187	0.375		
					



Characteristics:

Multipurpose profiling toolholder equipped with rhombic positive insert (angle 35°).

For general applications, roughing, semi-finishing and finishing.

Axial 0°
Radial 0°

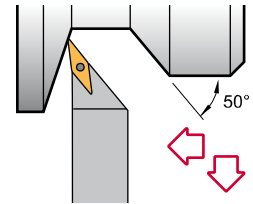
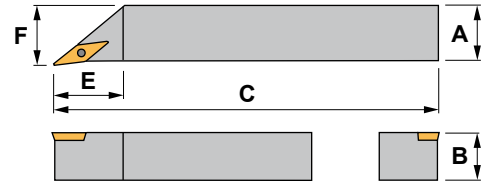

SVJCR 93°

i Automatic lathes

Reference	A	B	C	E	F	Insert size	
SVJCR/L062D	0.375	0.375	6.00	0.940	0.375	VC..22..	0.220
SVJCR/L082D	0.500	0.500	6.00	0.940	0.500	VC..22..	0.308
SVJCR/L103D	0.625	0.625	6.00	1.440	0.625	VC..33..	0.308

Reference			Nm
SVJCR/L062D	1225	5507	0.9
SVJCR/L082D	1225	5507	0.9
SVJCR/L103D	1240	5515	3.0

VC..

35° rhombic positive inserts with 7° clearance. **i** A40

Reference	l	T	d
VC..22..	0.433	0.125	0.250
VC..33..	0.650	0.187	0.375

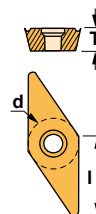

VCGT-AL



VCGT-AP



VCMT







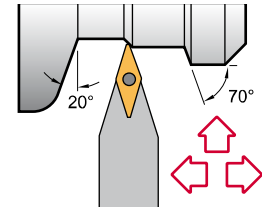
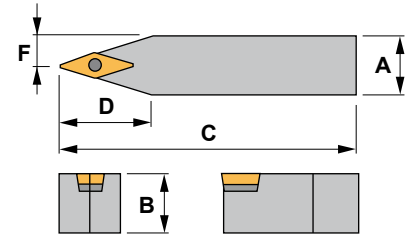

Characteristics:
 Multipurpose profiling toolholder equipped with rhombic positive insert (angle 35°).
 For toolholders with negative inserts see Ref. MVVN (Page: A98).

Axial 0°
 Radial 0°



SVVC 72°30'

Reference	A	B	C	D	F	Insert size	lbs
SVVCN123B	0.750	0.750	4.50	1.212	0.398	VC..33..	0.880
SVVCN163D	1.000	1.000	6.00	1.610	0.523	VC..33..	1.540
SVVCN203D	1.250	1.250	6.00	2.008	0.648	VC..33..	2.755

Reference					Nm
SVVCN123B	1335	5516	3718	1750	3.0
SVVCN163D	1335	5516	3718	1750	3.0
SVVCN203D	1335	5516	3718	1750	3.0

VC.. 35° rhombic positive inserts with 7° clearance.  A40

Reference	l	T	d
VC..33..	0.650	0.187	0.375

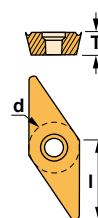

VCGT-AL



VCGT-AP



VCMT



Nominal cutting speed and feed values for toolholders

Material	P	Type of treatment	Alloy	Hardness HB
Non alloyed steel		Annealed Annealed Tempered	≤ .15% C .15% - .45% C ≥ .45% C	125 150-250 300
Low alloyed steel		Annealed Tempered Tempered		180 250-300 350
High alloyed steel		Annealed Tempered		200 350
Corrosion-resistant steel		Annealed Tempered	ferritic martensitic	200 325
Material	M	Type of treatment	Alloy	Hardness HB
Stainless steel		Annealed Quenched Quenched Hardened	ferritic / martensitic austenitic duplex martensitic / austenitic	200 180 230-260 330
Material	K	Type of treatment	Alloy	Hardness HB
Gray cast iron			pearlitic / ferritic pearlitic / martensitic	180 260
Spheroidal cast iron			ferritic pearlitic	160 -
Malleable cast iron			ferritic pearlitic	130 230
Material	N	Type of treatment	Alloy	Hardness HB
Aluminium wrought alloys		Non hardened Hardened		60 100
Aluminium cast alloys		Non hardened Hardened Non hardened	< 12% Si < 12% Si < 12% Si	80 90 130
Copper and copper alloys (bronze, brass)			machining alloy stock (1% Pb) brass, red bronze bronze lead-free copper and electrolytic copper	- 90 100 100
Non-metallic materials			thermosetting plastics fiber-reinforced plastics hard rubber	- - -
Material	S	Type of treatment	Alloy	Hardness HB
Heat-resistant alloys		Annealed Hardened Annealed Hardened Cast	Fe-base Fe-base Ni or Co-base Ni or Co-base 30 - 58 HRC Ni or Co-base 1500 - 2200 N/mm ²	200 280 250 - -
Titanium alloys			pure titanium alpha + beta alloys	R _m 440* R _m 1050*
Material	H	Type of treatment	Alloy	Hardness HB
Tempered steel		Hardened and tempered Hardened and tempered		55 HRC 60 HRC
Chilled castings		Cast		400
Tempered cast iron		Hardened and tempered		55 HRC

* R_m = ultimate tensile strength, measured in MPa



Uncoated carbide		Coated carbide						Cermet
KM15	ZR10	TK15	TN15	TN30	TN35	TS15	TS20	NC25
V _c (sfpm)	V _c (sfpm)	V _c (sfpm)	V _c (sfpm)	V _c (sfpm)	V _c (sfpm)	V _c (sfpm)	V _c (sfpm)	V _c (sfpm)
-	-	754-1476	853-1640	585-748	-	-	-	1312-1706
-	-	656-1115	722-1312	553-618	-	-	-	1148-1312
-	-	525-886	590-984	423-488	-	-	-	984-1148
-	-	656-1181	853-1312	553-618	-	-	-	1312-1440
-	-	492-951	656-1050	293-488	-	-	-	984-1180
-	-	426-853	492-918	228-423	-	-	-	820-984
-	-	492-951	590-1050	390-650	-	-	-	1017-1245
-	-	328-853	394-918	163-325	-	-	-	917-1312
-	-	525-951	656-1050	455-585	-	-	-	1148-1312
-	-	426-820	492-918	358-520	-	-	-	851-1017
Uncoated carbide		Coated carbide						Cermet
KM15	ZR10	TK15	TN15	TN30	TN35	TS15	TS20	NC25
V _c (sfpm)	V _c (sfpm)	V _c (sfpm)	V _c (sfpm)	V _c (sfpm)	V _c (sfpm)	V _c (sfpm)	V _c (sfpm)	V _c (sfpm)
-	-	-	722-984	455-650	140-200	492-656	423-715	820-1050
-	-	-	-	358-618	110-190	394-656	390-585	984-1148
-	-	-	-	260-488	80-150	294-525	163-293	-
-	-	-	-	179-244	55-75	197-263	-	689-820
Uncoated carbide		Coated carbide						Cermet
KM15	ZR10	TK15	TN15	TN30	TN35	TS15	TS20	NC25
V _c (sfpm)	V _c (sfpm)	V _c (sfpm)	V _c (sfpm)	V _c (sfpm)	V _c (sfpm)	V _c (sfpm)	V _c (sfpm)	V _c (sfpm)
394-525	455-656	492-1312	459-1214	-	-	394-525	-	1114-1573
294-458	328-525	590-1148	459-1082	-	-	294-425	-	853-1180
425-558	522-656	656-1476	623-1410	-	-	394-525	-	1181-1706
294-425	361-492	525-984	459-886	-	-	394-589	-	984-1312
458-656	525-722	656-1804	590-1706	-	-	458-722	-	1081-1640
394-525	458-589	525-1148	492-1082	-	-	361-525	-	589-1050
Uncoated carbide		Coated carbide						Cermet
KM15	ZR10	TK15	TN15	TN30	TN35	TS15	TS20	NC25
V _c (sfpm)	V _c (sfpm)	V _c (sfpm)	V _c (sfpm)	V _c (sfpm)	V _c (sfpm)	V _c (sfpm)	V _c (sfpm)	V _c (sfpm)
984-11480	984-9840	-	-	-	-	328-1968	-	-
656-6560	656-8200	-	-	-	-	328-1312	-	-
1312-4920	1312-6560	-	-	-	-	328-1968	-	-
1312-4920	1312-5904	-	-	-	-	328-1312	-	-
656-2624	656-3280	-	-	-	-	328-1312	-	-
820-1968	820-2624	-	-	-	-	328-1968	-	-
656-1968	656-2624	-	-	-	-	328-1968	-	-
492-1312	492-1968	-	-	-	-	328-1312	-	-
492-984	492-1312	-	-	-	-	328-1312	-	-
261-589	328-7216	-	-	-	-	-	-	-
197-492	263-656	-	-	-	-	-	-	-
328-820	328-656	-	-	-	-	-	-	-
Uncoated carbide		Coated carbide						Cermet
KM15	ZR10	TK15	TN15	TN30	TN35	TS15	TS20	NC25
V _c (sfpm)	V _c (sfpm)	V _c (sfpm)	V _c (sfpm)	V _c (sfpm)	V _c (sfpm)	V _c (sfpm)	V _c (sfpm)	V _c (sfpm)
-	115-164	-	-	-	-	66-164	260-390	-
-	82-130	-	-	-	-	66-164	195-325	-
-	82-130	-	-	-	-	48-130	114-293	-
-	66-97	-	-	-	-	66-115	98-163	-
-	48-82	-	-	-	-	33-82	98-146	-
-	261-458	-	-	-	-	261-455	228-390	-
-	130-328	-	-	-	-	82-145	130-228	-
Uncoated carbide		Coated carbide						Cermet
KM15	ZR10	TK15	TN15	TN30	TN35	TS15	TS20	NC25
V _c (sfpm)	V _c (sfpm)	V _c (sfpm)	V _c (sfpm)	V _c (sfpm)	V _c (sfpm)	V _c (sfpm)	V _c (sfpm)	V _c (sfpm)
-	-	-	-	-	-	-	-	-
-	-	-	-	-	-	-	-	-
-	-	-	-	-	-	-	-	-
-	-	-	-	-	-	-	-	-

