

OWNER'S MANUAL

Model Covered: BD50QT-2A, BD50QT-3A, BD50QT-4A
BD50QT-9A, BD50QT-12A, BD50QT-18A
BD50QT-20A, BD50QT-25A, BD50QT-26A
BD50QT-27A

Boom International Holdings (USA), Inc.

Foreword

Thanks for your purchase of this motorcycle, which is produced by advanced technologies. It will bring you a joyful and safe riding.

Riding is one of the most exciting experiences. In order to bring into play your cycle's best performance, you should be very familiar with the rules and demands suggested in the manual before riding.

The manual summarizes motorcycle's general maintenance and service. As long as following the under-mentioned rules, you could ensure a long-term, smooth and trouble-free operation of your motorcycle.

The specification and design are subject to change without further notice. The shown weight and size are approximation.

Contents

Foreword.....	1
Contents.....	2
Important Information.....	3
Users' Notice.....	4
Parts Location.....	7
Operation.....	9
Fuel and engine Oil.....	14
Pre-ride Inspection.....	16
Main Points of Riding.....	17
Maintenance.....	21
Main Specification.....	30
Emission Related Parts List.....	31
Emission Control System Warranty.....	32

Important Information

The initial 1500 kilometers is very important in the cycle's whole running life, and the correct running-in in this period could ensure the vehicle's longest life and best performance.

Careful and patient running-in will provide you with smooth riding and excellent performance. It is important to avoid operation that may lead to overheat to engine parts.

Please read the running-in section to master operation methods.

Please read through this manual and abide by each rule and illustration.

Pay special attention to the part assigned these words.

Warning: means you should be highly alert to a serious danger that may lead to personal injury or loss of life unless the rule is followed.

Caution: means you should be alert to a middle-serious danger that may bring damage to parts or injury to the driver unless the instruction is followed.

Note: means you should be alert to light danger. The note makes the important illustration clearer and you can avoid the damage to parts if the rules are followed.

User's Notice

Accessory assembly and safety rules

You can select various kinds of accessories to assemble on your motorcycle, but improper assembly may bring about danger and damage, so we set up some rules to help you select the right accessory and assemble your cycle in a correct way.

1. When loading additional cargo or installing accessories that may add to the air resistance, keep the center of gravity of cargo low and close to the center of gravity of the motorcycle. You must check the rack and other parts are installed carefully and make sure that they are secure enough. Otherwise, offset of the center of gravity may induce danger.
2. Check and make sure the cycle's minimum ground clearance and inclination toward the side are appropriate. Improper installation of accessories is very likely to decrease these two items safety factor. At the same time, make sure the installation doesn't prevent you from parking, turning and other operation.
3. If you install accessories at the steering stem or the fore fork, the steering may be influenced, and the load may induce vibration of the fore parts. Therefore, the weight of accessories on.
4. Greater air resistance caused by windshield, backrest, and travelling box may influence

the cycle's stability. Improper installation or badly designed accessories would endanger riding, so you must be careful to select and install these accessories.

5. The installation of accessories mustn't restrict the rider's operation.
6. Additional electric devices may render primary coil overloaded, and serious overload may damage the electric devices, and more seriously, result in danger because of insufficient power of the motorcycle battery when riding.

Do as follows for safe ride:

For your safety, you must obey the following 9 rules while riding the motorcycle:

(1) wear helmet

Safe ride begins with putting on helmet. You must wear helmet while riding.

(2) Wear simple and convenient clothes

Pay attention to avoid wearing strange and loose clothes. Please wear tight and closed clothes to ensure that your hands and feet move freely.

(3) Check before riding

Please read carefully the contents in Pre-ride Inspection of the manual. Always check before starting the engine.

(4) Get familiar with the structure and performance of this motorcycle.

Your driving skills and knowledge of the structure of this motorcycle are the basis of

riding.

You should practice riding in an open area without vehicles to master riding skills.

(5) Get to know the speed limit of safe riding

The motorcycle's safety speed depends on the ground condition and your riding skills.

Knowing the speed limit of your safety riding can avoid accidents.

(6) Do not ride after drinking or taking medicine.

(7) Forbid the immature to ride motorcycle.

(8) Pay special attention to riding in rain

Riding on wet roads is very dangerous. Forbid turning during acceleration and keep safe distance with the front vehicles. Remember that the braking distance in rain is twice of that in sunny days, and please pay special attention to traffic signs. Once the condition of the road changes, reduce the speed.

(9) This type of motorcycle is suitable to ride on planar roads.

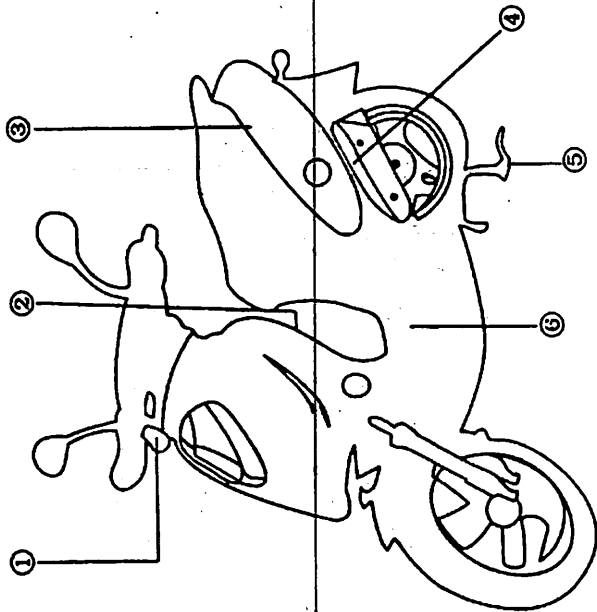

① Front L. winker

② Front luggage box

③ Seat lock

④ Air cleaner

⑤ Side stand

⑥ Battery

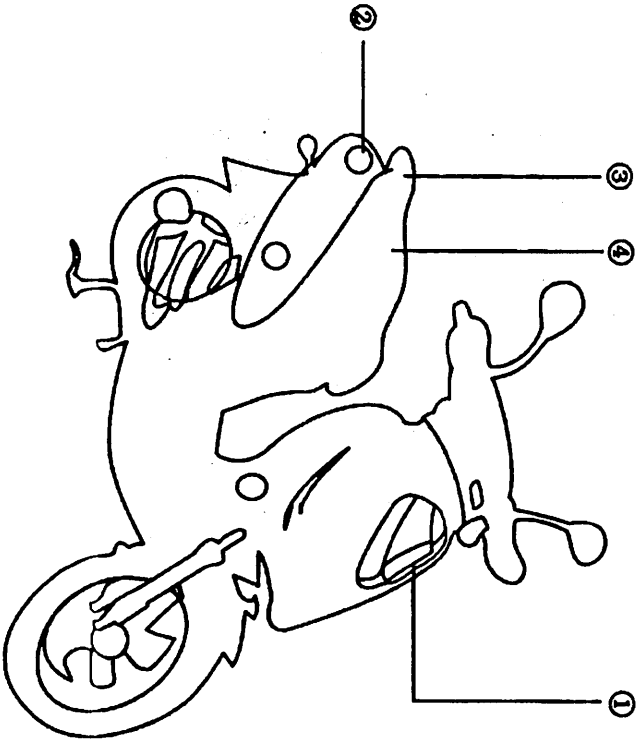

① Lgnition lock

②Rear winker

③Rear carrier

④Rear luggage box

Speed Meter

1. Speedometer: It shows the driving distance per hour in terms of kilometer.
2. Fuel Meter: It shows the quantity of fuel.

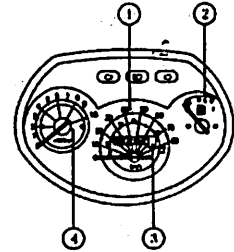

Indicating the fuel volume in the fuel tank. It works when the ignition switch is "ON", and doesn't work when the igniton switch is "OFF". "F" means full, and "E" means empty. When the pointer is in the red zone, the fuel will soon be used up, refill fuel immediately.

3. Odmeter: It records the distance traveled, in terms of kilometer.
4. Tachometer: It shows the engine rotations per minute.

Ignition switch

“(OFF)  ”: All the circuits are closed and the key can be taken off..

“(ON)  ”: All the circuits are open and the engine can start.

But the key can't be taken off.

Left handlebar

Headlight dimmer switch (1)

When the beam switch is turned to “  ”, the high beam is turned on.

When the switch is turned to “  ”, the low beam is turned on.

Turn Signal Indicator Switch (2)

When the turning switch is turned to “  ”, the left turning light will flash.

When the turning switch is turned to “  ”, the right turning light will flash.

Horn button (3)

When the ignition switch is at “ON”, press down this button and the horn will sound.

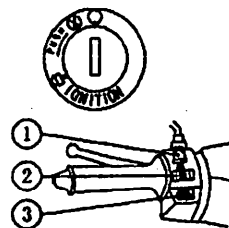

Right handlebar

Electric Start Button(4)

When starting the motorcycle by electricity, press the button, the engine can be started.

Throttle grip(5)

Control the speed of engine. To increase the speed, rotate the grip inward, vice versa.

Headlight switch(6)

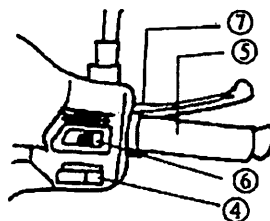

"  " In this position, headlight, taillight, meter-light and position light are all turned off at the same time.

"  " In this position, taillight, meter-light, position light are all turned on at the same time.

"  " In this position, headlight, taillight, meter-light and position light are all turned on at the same time.

Front brake lever(7)

When a front brake is made, hold tight the front brake lever towards yourself.

Fuel tank cap

Turn the cap anti-clockwise to remove it. After filling fuel, turn the cap clock wise to close it securely. When the fuel pointer on the panel approaches the red zone, you need to refuel as soon as possible with #90 above lead-free gasoline, but do not overfill.

Caution:

Refuel in a well-ventilated area with the engine stopped. Do not smoke or allow flames or sparks in the area where the motorcycle is refueled or where gasoline is stored. Turn the ignition key to "OFF".

Engine oil tank cap

Turn the cap lightly and lift it to remove the engine oil tank cap; turn the cap lightly and press it down to close the cap securely.

Fuel sensor

The fuel sensor has been fixed on the fuel tank. Please do not move it . The fuel volume is indicated on the panel with this sensor.

Steering Lock

To lock steering, turn the handlebar to left, then insert the ignition key steering lock and turn clockwise. Do not forget to lock the steering when parking.

Warning:

After the steering is locked, do not push the motorcycle, or you will lose balance.

Rear carrier

The maximum load for the carrier is 3kg~5kg, and the items must be packed securely.

Kick starter

The kick starter is on the left side of the engine and is used to start the engine.

Caution:

After the engine is started, you need to check where the kick starter has reverted to is normal position.

Fuel and Engine Oil

Fuel

You'd better use lead-free or low lead content gasoline, with an octane number of no less than 90

Caution:

Use lead-free or low lead content gasoline can lengthen the service of speak plug.

Engine oil

Use the special engine oil: SF10W/40

Maximum speed

The following table lists the maximum speed during running-in.

Running-in distance(km)	0-300	300-500	500-1000	1000-1500
Speed limit(km/h)	<25	<30	<35	<40

Caution:

Replace engine oil and gear oil with the specified brand when running-in distance reaches 300 kilometers.

Change engine speed

Don't keep the engine running at constant speed but change it frequently, which is helpful to parts running-in. In the running-in stage, it is necessary to impose proper stress on every engine part to ensure full running-in, but avoid overload.

Circulate engine oil before riding

~~After starting the engine in a hot or cold state, and before exerting load, or before the~~
engine runs, you must ensure that the engine has enough idling time to circulate the lubrication oil to every important engine part.

Perform the first but also the most important maintenance.

Maintenance in the initial 1000km is the most important of all. Perform all the adjustment well, tighten all the fasteners and replace the dirty oil. Timely 1000km maintenance will ensure that the engine has good performance and longer service life.

Inspection	Item Inspection Objective
Steering	1)Smooth 2)No operation restriction 3)No clearance or loose
Brake	1)Free travel of pedal and lever 2)No "spongy" state 3)Brake reliably
Tire	1)Correct pressure 2)Suitable figure depth 3)No cutting
Fuel	There is enough gasoline to ride planned distance
Lights	Operate all lights: headlight, taillight, position light, stop light, instrument indicator lights and turn signal lights to check their functions
Indicator lights	High beam and turn signal indicator lights are normal
Horn button	Normal performance
Engine oil	Enough
Throttle	1)Correct free travel of throttle grip 2)The throttle grip has smooth operation and reliable reversion to the closed position
Instruments	All the functions are normal
Exhaust muffler	1)Exhaust normally 2)The noise is normal 3)No loose

Tips for driving

Warning:

You should practice driving in a safe and spacious area if you ride this type of motorcycle for the first time.

Riding with one hand is extremely dangerous; you should hold the two handlebars tightly with your both hands. In no circumstances can you release the handlebars.

Do not accelerate when turning. You must reduce the speed to safety range. If the ground is wet or slippery, you must reduce the speed.

At the exit of a tunnel or valley or when meeting large vehicles, you must to careful and reduce the speed. Obey the transportation rules and limit your speed.

Engine start

Before start, you should check the engine oil and fuel.

Before starting the engine, support the motorcycle with main stand.

Warning:

To prevent the motorcycle from dashing out after starting, you must brake the rear wheel tightly. If the clearance of rear brake cable is not correct, the rear wheel cannot be braked tightly, so as to bring about danger.

(1) Step down the rear brake pedal.

(2) Turn the ignition key to "ON".

(3) Engine start:

Open the throttle a little, press down the electrical start button and the engine will be started.

Warning:

You must release the button after the engine is started.

When the engine is running, do not press the button, or the engine parts may be damaged.

When starting the engine, the rear brake should be working. After the engine is started, the brake light should be on.

If the engine won't start after 3~4 seconds, open the throttle a little larger will make start easier.

Before starting the engine in a "cold" state, you should kick the starter several times to let the engine get lubricated.

After the engine is started, you should let it run for a short moment to warm it up.

Start the engine with kick starter

You need not turn the throttle control handle, just kick down the starter rod.

Caution:

After the engine is started, you should revert the start rod, or it may affect ride safety.

Start the engine with kick starter

You need not turn the throttle control handle, just kick down the starter rod.

Caution:

After the engine is started, you should revert the start rod, or it may affect ride safety.

Use Brake and Parking

Completely close the throttle and use the front and rear brake evenly. Inexperienced users use only the front brake or the rear brake. This will aggravate the wear of the brake and lengthen the brake distance.

Caution:

It is very dangerous to use only the front or the rear brake. It may cause the motorcycle skid or lose control. You should be extremely careful to handle the brakes on wet or slippery roads. An emergency brake is especially dangerous.

No sharp brake and turn

Sharp brake and turn are the causes of skid and fall off, which are very dangerous, so you must avoid it.

Parking

(1) Near parking area

Turn on the turn signal light in advance and be careful of the vehicles coming from the side and rear, then park slowly.

Release throttle handle and use front and rear brakes in advance. Meanwhile the brake light will be on to warn the rear vehicles.

(2) Stop completely

Shut off the turn signal light and turn the ignition key to? OFF?

(3) Park

Park on planar road not affecting traffic with side stand or main stand.

Lock the steering to ensure safety.

Caution:

Do not shut off ignition switch when driving.

The higher the speed, the longer the braking distance. So you must keep safe distance with other vehicles or objects.

Because the exhaust muffler is very hot, do not park the motorcycle in places accessible by passengers and kinds. You should not park your cycle on slope or loose ground lest it should turn over.

Inspection and Maintenance

The periodic table of maintenance & Repair

Please inspect and maintain your motorcycle periodically to ensure safe ride, good performance, long service time and reduced pollution.

I:inspection, cleaning if necessary, lubrication, replacement, and adjustment

~~A: Adjustment C: Cleaning R: Replacement L: Lubricate T: Tightening~~

Note:

1. Should be serviced by an authorized dealer, unless the owner has special tools and service material and is mechanically qualified.
2. Clean more frequently when riding in dusty and moisture areas or in bad condition road.

Items 保养项目	Maintenance period 保养周期	Odometer (km) 里程数						Everyday check before riding 每次骑车前进行日常检查
		1000	4000	6000	8000	10000	12000	
Engine Oil 润滑油		R	R	R	R	R	R	I
Spark Plug 火花塞			I		I		R	
Valve Gap 气门间隙			A		A		A	
Idle Speed 怠速转速			A		A		A	I
Engine Bolt 缸头螺栓			I		I		I	
Oil Filter 机油滤清器			C		C		R	
Gear Oil 齿轮油			R		R		R	
Fuel Filter 汽油滤清器			R		R		R	
Air Cleaner 空滤器			C	C	C	C	R	
Throttle Operation 油门控制			I		I		I	I
Brake Shoes/Pad Wear 刹车片磨损			I		I		R	
Brake System 制动系统			I		I		I	
Brake Light Switch 制动灯开关			I		I		I	I
Brake Liquid 制动液			I		I		R	
Suspension 悬挂系统			I		I		I	
Nuts, Bolts, Fasteners 紧固件			I		I		I	
Wheel/Tyre 轮胎			I		I		R	I

Battery

There are two kinds of battery for this model, and the maintenance modes are as follows:

1. This model use dry battery, and the battery electrolyte doesn't need check and replenishment.

Caution:

The cover of dry battery mustn't be removed.

The battery will discharge if it is not in use for long. After charging the battery to full capacity, place it in a well-ventilated area.

To protect the environment, the battery must be properly disposed when it is discarded, Please take down the negative wire if motorcycle is not in use for long.

2. You can also use battery that needs maintenance. The electrolyte level should be maintained between the upper and lower level marks. If the electrolyte level is lower, carefully add distilled water. Keep the venttube unblocked.

The battery head

Please dismount the 4 screws on the battery cover and remove the battery cover.

Please take out the battery for cleansing if the battery head is eroded.

Please spread the battery head with a thin layer of butter or Vaseline and then mount the battery again.

Caution:

When dismantling the battery, you must turn off the ignition switch and then dismantle the negative pole(-). Mount the positive pole(+) first and then the negative pole.

Make sure to fasten the screws on the battery head if they get loose.

To change fuse

Turn off the ignition switch and inspect whether the fuse has melted. Please choose fuse with the specified capacity.

Please replace the fuse after checking the reason for melting.

The fuse is in the fuse case beside the battery.

Open the fuse case and take out the fuse.

Fuse specification: 10A**Air cleaner**

If the element of the air cleaner is covered by dust, the inhaling resistance will increase and the output power would decrease, thus increasing fuel consumption. So after every 1000km of ride, you need to check and clean the element.

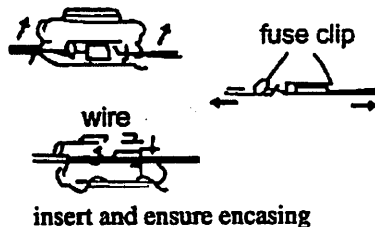

Caution:

If you ride in dusty areas, the element should be cleaned and replaced more frequently. When the element hasn't been mounted, you mustn't start the engine.

To run the engine without element of air cleaner will quicken the engine wear. You should make sure frequently that the element is in good condition because it affects the service life of the engine greatly.

Brake

After the initial 1000km and every 3000km of ride, you should check the brake.

Front Brake**Adjustment of front brake**

1. Measure the clearance from beginning to stop of brake. This measurement is 10-20mm.
2. If the clearance needs to be adjusted, rotate the adjusting nut on the brake arm. Be sure that the arced slot of adjusting nut's head is well fit with brake arm pin.
3. Experiment on front braking by holding the tight fore brake lever several times, and see whether the wheels revolve smoothly after releasing brake.

The adjusting of the rear brake is primarily the same as above, Rotate the adjustment nut on the rear brake arm to make the free travel reach the normal value 10-20mm.

Spark plug

For the initial 1000km and every 3000km, use steel brush or spark plug cleaner to clean the carbon deposit on the spark plug. Measure the gap of the two electrodes and ensure it's kept an 0.6~0.7mm.

Replace the spark plug after every 6000km.

Check of spark plug

(1) Take down the spark plug and connect it with the plug entrance.

(2) Turn the ignition switch to "ON", and let the spark plug near the engine outside and start the engine. If the ignition system is normal, there will be blue sparks in the plug gap. If there is no spark, you need to ask the service station for repair.

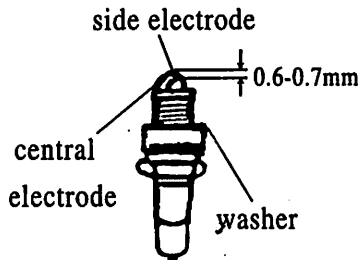

Caution:

The temperature is very high shortly after the engine stops. Be careful not to be scalded. You should tighten the plug with your hand first, then with a plug wrench.

To replace gear oil

1. Support the motorcycle with main stand on planar ground.
2. Take off the discharging bolt and the infusing bolt.
3. Perform the replacement when the engine is hot. At this time the residual oil in the gear box flows out easily.
4. Tighten the discharging bolt after cleaning it.
5. Make sure than the infusing bolt is tightened after the oil is infused to prevent it from leaking. Replace the gear oil at the initial 300km, and per 2000km or half a year afterwards.

Caution:

Please replace the gear oil regularly under following conditions.

Driving in the rain commonly

Long time driving

Driving with heavy load

Tire

You need to check the inflation pressure and tire figure. To ensure the highest safety and longer service life, you need to check the inflation pressure frequently.



Tire Pressure

Inadequate tire pressure will not only quicken the tire wear but also affect the ride stability. Low pressure will make turning difficult. But too high pressure may also lead to skid and even loss of control. The pressure must be kept within specified range. Pressure adjustment should be done when the tire is cold.

Fore Wheel	
Rear Wheel	

Warning:

Operation with excessively worn tire is hazardous and will adversely affect traction, stability, steering and handling.

Prior to riding, tire inflation should be checked when the tires are "cold". Make sure that there are not cutting, nails or sharp pieces in the tires, that there is no dent or deforming of the rim. Improper tire inflation will cause abnormal tread wear and create a safety hazard.

Under inflation may result in the tire damaged, or coming off from the rim.

Replace the tires when the central tread depth of the tires reaches the limit of 1.6mm.

Throttle cable adjustment

- (1) Loosen the lock nut.
- (2) Turn the adjuster to adjust the clearance, so that the choke lever is in the range of 5° ~ 10°
- (3) Fasten the lock nut again after the adjustment is done.

Failure Solution

If the engine can not be started, please make the following check for reasons.

-
- (1) If the fuel in the fuel tank is enough.
 - (2) If the fuel flows through the fuel cock to the carburetor.
 - (3) Cut fuel to the carburetor and turn the cock switch to OPEN, and see whether there is fuel flowing out from hose.
 - (4) If fuel can get into the carburetor without fail, you should check the ignition system.

Engine Stop

- (1) Check the fuel reserve in the fuel tank.
- (2) Check the ignition system for its performance.
- (3) Check the idle speed of engine.

ENGINE MODEL	4 stroke, single cylinder, forced air-cooled	NET EWIGHT	80kg
WORKING VOLUME	51ml	MAXIMUM LOAD	75kg
STARTING MODEL	Electrical/kick starter	TIRE SPECIFICATION	Fore/rear:3.50-10/3.50-10
CLUTCH	Dry, inner-flowing Automation centrifugal	FUEL TANK CAPACITY	4.5L
LUBRICATION MODEL	Multiple lubrication	FUEL	No.90 and above lead-free gasoline
SHIFT MODEL	Stepless	BATTERY	12V 7AH
MAXIMUM SPEED	50km/h	FUSE	10A
FULL LENGTH	1860mm	SPARK PLUG	A7RTC
FULL WIDTH	765mm	SPARK PLUG GAP	0.6-0.7mm
FULL HEIGHT	1020mm	ENGINE OIL TYPE	SF 10W/40
WHEEL BASE	1300mm	ECONOMICAL FUEL CONSUMPTION	≤2.0L/100km
MIN.GROUND CLEARANCE	100mm		

Emission Related Parts List

Part Nomenclature	Part Manufacturer Name	Part Number
Catalytic Converter	LYDSTECH(CHINA)COMPANY	LYDS 4315MCMI
Secondary Air Injection	Nanchong zhaoqing machine manufacturing Co.,Ltd.	ZQ Z531-125-3
Carburetor	Fujian youli Carburetor Co.,Ltd.	PD18J
Muffler	Taixing Electromechanical Equipment Welfare Factory	JD BD50QT-2A-1101000-D
CDI(ECU)	Chongqing Xianfeng Electronics Co., Ltd.	XFDJ12
Spark Plugs	Zhuzhou torch spark plug Co.,Ltd.	A7RTC
Fuel Tank	WUXI ZHENGDA FUEL TANK MANUFACTURE CO.,LTD.	BD125T-5B-2001000
Fuel Tank Cap Cover	ZHEJIANG ZHENGDONG VEHICLE FITTINGS CO.,LTD.	BD125T-5B-2702000
Air Cleaner	Zhejiang Hengbo Air-filter Co.,Ltd.	HB BD50QT-2A-1003000
fuel line	XIAMEN JINBEIDE RUBBER SCIENCE&TECHNOLOGY CO.,LTD.	JINBEIDE EPA-XJR-A15-AAA NRFL Q-12-016A
Air Injection Valve	Nanchong zhaoqing machine manufacturing Co.,Ltd.	ZQ Z531-125-3

EMISSION CONTROL SYSTEM WARRANTY

YOUR WARRANTY RIGHTS AND OBLIGATIONS

The emission control system warranty period for this vehicle begins on the date the vehicle is delivered to the ultimate purchaser, continues for 60 months after that date, or (Class I, 12,000 km; Class II, 18,000 km; Class III, 30,000 km) which ever comes first, provided there has been no abuse, neglect improper maintenance of your vehicle. Where a warrantable condition exists, the Manufacturer will repair your vehicle at no cost to you, including diagnosis, parts and labor. If an emission-related part on your vehicle is defective, the part will be repaired or replaced by the Manufacturer. This is your emission control defects warranty.

OWNER'S WARRANTY RESPONSIBILITIES

As the vehicle owner, you are responsible for the performance of the required maintenance. You should maintain a record of all maintenance performed on your vehicle and retain all receipts covering maintenance on your vehicle. You may not be denied a warranty claim solely because of your failure to ensure the performance of all scheduled maintenance or lack of maintenance records or receipts. You are responsible for presenting your vehicle to a dealer as soon as a problem exists. The warranty repairs should be completed in a reasonable amount of time, not to exceed 30 days.

As the vehicle owner, you should be aware that you may be denied your warranty coverage if your vehicle or a part has failed due to abuse, neglect, improper maintenance, or unapproved modifications.

WARRANTY COVERAGE

The Manufacturer warrants that each new 2008 and later vehicle:

- is designed, built, and equipped so as to conform at the time of initial retail purchase with all applicable regulations of the United States Environmental Protection Agency, and the California Air Resources Board; and
- is free from defects in material and workmanship which cause such vehicle to fail to conform with applicable regulations of the United States Environmental Protection Agency or the California Air Resources Board for the periods specified above.

Your emission control system warranty covers components whose failure would increase an engine's emission, including electronic controls, fuel injection system, carburetor, the ignition system, catalytic converter, or any other system utilized in this vehicle to control emissions as originally equipped. Also included may be hoses, connectors and other emission-related assemblies. The owner is responsible for proper maintenance. Replacing or repairing other components (including parts, labor, and other costs) not covered by this emission control system warranty or the standard warranty is also the responsibility of the owner.

The Manufacturer will not cover repairs performed outside of a dealer or repair facility, except in an emergency situation. The use of replacement parts not equivalent to the original parts may impair the effectiveness of your vehicle's emission control system. If such a replacement part is used and a dealer determines it is defective or causes a failure of a warranted part, your claim for repair to bring your

vehicle into compliance with applicable standards may be denied.

If an emergency situation exists when a warranted part or a dealer is not reasonably available to the owner, repairs may be performed at any available service establishment, or by the owner, using any replacement part. The Manufacturer shall reimburse the owner for the expenses, including diagnostic charges, not to exceed the Manufacturer's suggested retail price for all warranted parts replaced and labor charges based on the Manufacturer's recommend time allowance for the warranty repair and the geographically appropriate hourly labor rate. The owner may reasonably be required to keep receipts and failed parts in order to receive compensation.

This Emission Control System Warranty is in addition to the standard Limited Warranty.

EXCLUSIONS AND LIMITATIONS

This warranty does not cover the following:

- Failures or malfunctions of the emission control systems caused by abuse, alteration, accident, misuse, the use of leaded gasoline.
- Replacement of expendable maintenance items unless they are original equipment defective in material or workmanship under normal use, and the first required replacement interval for the item has not been reached. Expendable maintenance items include but not limited to spark plugs, filters, coolant, lubricants, gaskets, hoses, and belts.
- Replacements of parts and other services and adjustments for required maintenance.
- Any vehicle equipped with an odometer or hour meter where the reading is altered so that actual mileage cannot be readily determined.

- Repairs or replacements as a result of:
 - Accident
 - Misuse
 - Use of replacement parts or accessories not conforming to the original specifications which adversely affect performance
- Physical damages, corruptions, or defects caused by fire, explosions or similar causes beyond the control of the Manufacturer.
- Failures not caused by a defect in material or workmanship.

Use of the vehicle in any type of competitive racing or related events immediately and completely voids this and all other warranties.

LIMITED LIABILITY

The liability of the Manufacturer under this Emission Control System Warranty is limited solely to the remedying of defects in material workmanship by a dealer at its place of business during customary business hours. This warranty does not cover in convenience or loss of use of the vehicle or transportation of the vehicle to/from the dealer. The Manufacturer is not liable to any person for incidental, consequential or special damages of any description, whether arising out of express or implied warranty or any other contract, negligence or other tort or otherwise.

No express emission control system warranty is given by the Manufacturer except as specifically set forth herein. Any emission control system warranty implied by law, including any warranty of merchant ability

or fitness for a particular purpose is limited to the express emission control system warranty terms stated in this warranty. The foregoing statements of warranty are exclusive and in lieu of all other remedies. All express warranties not stated in this warranty are disclaimed. Some states do not allow limitations on how long an implied warranty lasts, so the above limitations may not apply if it is inconsistent with the controlling state law.

No dealer is authorized to modify this Emission Control System Warranty. If you have any questions regarding your warranty rights and responsibilities, you should contact Boom International Holdings(USA) Inc. at 1-855-390-7767 or the California Air Resources Board, 9528 Telstar Avenue, El Monte, CA 91731 (for California registered vehicles only).

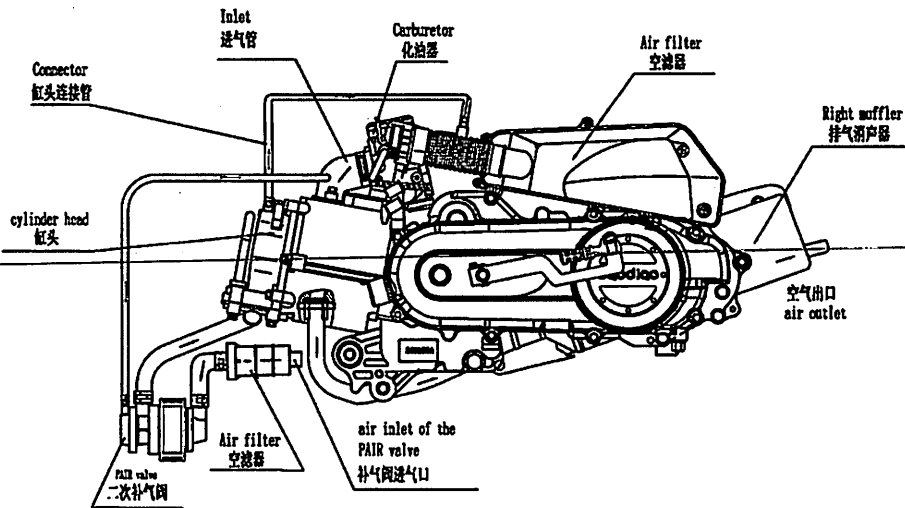

工作原理说明：曲轴箱气体通过缸头上的通气管进入空滤器，随新鲜空气进入气缸再次燃烧。

Crankcase gas will be going into air filter through the inlet of cylinder head, and the gas will be going back to cylinder ,return with fresh air.

BD50QT-2A



BD50QT-3A



BD50QT-4A



BD50QT-9A



BD50QT-12A



BD50QT-18A



BD50QT-20A



BD50QT-25A



BD50QT-26A



BD50QT-27A

