

210mm

285mm

OWNER'S MANUAL

S5-150 (STORM 150 DLX)

STOP! MUST READ
PLEASE REMEMBER TO VIEW THE ASSEMBLY VIDEO
BEFORE PROCEEDING!

For **Assembly video** and **Troubleshooting Tips**,
please visit below link or scan the QR code below with your mobile phone.
tinyurl.com/xpro195



S5-150(STORM 150 DLX)/DB-K016 Dirt Bike

Owner's Manual

This manual should be considered a permanent part of the motorcycle and should remain if it is resold.

This manual contains the latest product information available before printing. We reserves the right to make changes at any time without notice and without incurring any obligation.

No part of this publication may be reproduced without written permission.

IV. Legal Rights. This warranty gives you specific legal rights, and you may also have other rights which vary from state to state.

V. This emission control system warranty is in addition to the standard limited warranty for all vehicles.

VI. Additional Information. Any replacement part that is equivalent in performance and durability may be used in the performance of any maintenance or repairs. However, Zuma Extreme Sports is not liable for these parts. The owner is responsible for the performance of all required maintenance. Such maintenance may be performed at a service establishment or by any individual. The warranty period begins on the date the motorcycle is delivered to an ultimate purchaser.

Zuma Extreme Sports Co.,Ltd.
1942 Broadway St. STE 314C, Boulder, CO 80302
U.S.A
TEL: 866-991-2128

IMPORTANT

PLEASE READ THIS MANUAL CAREFULLY AND COMPLETELY BEFORE GOING ON YOUR FIRST RIDE. IT CONTAINS A GREAT DEAL OF INFORMATION AND ADVICE WHICH WILL HELP YOU USE AND HANDLE YOUR BIKE PROPERLY.

Please write the serial numbers of your motorcycle in the boxes below

Chassis (VIN) Number

Engine Number

Key Number (If Available)

Dealer Stamp

CONSUMER INFORMATION FOR UNITED STATES Tampering with noise & emissions control systems is prohibited

Owners are warned that the law prohibits:

A. The removal or rendering inoperative by any person other than for purposes of maintenance, repair or replacement, of any device or element of design incorporated into any new vehicle for noise and/or emissions control prior to its sale or delivery to the ultimate purchaser or while it is in use; and

B. The use of the vehicle after such device or element of design has been removed or rendered inoperative by any person.

We reserves the right to modify any equipment, technical specifications, colors, materials, services offered and rendered, and the like so as to adapt them to local conditions without previous announcement and without giving reasons, or to cancel any of the above items without substituting them with others. It shall be acceptable to stop manufacturing a certain model without prior notice. In the event of such modifications, please ask your local dealer for information.

CONTENTS

CONTENT	04	SUSPENSION SYSTEM	40-45
INTRODUCTION	05	FRONT SUSPENSION INSPECTION	40
EPA OFF ROAD MOTORCYCLE SPECIFICATIONS	06	FRONT SUSPENSION ADJUSTMENT	41-42
SAFETY INFORMATION FOR PARENTS	07-09	REAR SUSPENSION INSPECTION	40
SAFETY LABEL INFOS & 150CC BIKE PHOTOS	10-13	REAR SUSPENSION ADJUSTMENT	43-45
COMPONENT LOCATIONS	14	RIMS, TIRES & SPOKES	46-47
SERIAL NUMBER LOCATIONS	15	TIRE AIR PRESSURE	46
HANDLE BAR LEVER CONTROLS	15	TIRE INSPECTION	47
OPERATING CONTROLS	16-17	TIRE AND TUBE REPLACEMENT	47
BEFORE RIDING	18	DRIVE CHAIN SYSTEM	48-52
PROTECTIVE GEAR & APPAREL	18	DRIVE CHAIN INSPECTION	48
IS THE MOTORCYCLE READY TO RIDE	19	DRIVE SPROCKET INSPECTION	49
PRE-RIDE INSPECTION	19	CHAIN ROLLER INSPECTION	49
BASIC OPERATION & RIDING	20	CHAIN SLIDER INSPECTION	50
SAFE RIDE PRECAUTIONS	20-21	CHAIN ADJUSTMENT	51
ENGINE STARTING PROCEDURE	20, 21	CHAIN LUBRICATION	51
FLOODED ENGINE	21	CHAIN REMOVAL & REPLACEMENT	52
STOPPING THE ENGINE	21	TROUBLESHOOTING	53-59
SHIFTING GEARS	22	RESOLVING THE UNEXPECTED	60-61
BRAKING TECHNIQUE	23	WIRING HARNESS	62
PARKING & POST RIDE INSPECTION	23	MAINTENANCE SCHEDULE	63
MAINTAINING YOUR DIRT BIKE	24	EMISSION CONTROL SYSTEM WARRANTY	64-66
IMPORTANT SAFETY PRECAUTIONS	24		
MAINTENANCE SCHEDULE	25-27		
BASIC MAINTENANCE PROCEDURES	25-52		
FUEL, GASOLINE	28		
REFUELING & INSPECTION	28		
ENGINE OIL	29		
CHECKING & ADDING OIL	29		
CHANGING OIL	30		
CHANGING / CLEANING AIR FILTER	31		
THROTTLE SYSTEM	32		
ENGINE IDLE SPEED	33		
CLUTCH SYSTEM	34		
SPARK PLUG	35-36		
BRAKE SYSTEM	37-39		
BRAKE ADJUSTMENT	37		
BRAKE FLUID CHECK	37		
ADDING BRAKE FLUID	38		
BRAKE PADS	39		
BRAKE SYSTEM BLEEDING	39		

applicable regulations of the United States Environmental Protection Agency, and

- B. is free from defects in material and workmanship which cause such vehicle to fail to conform with applicable regulations of the United States Environmental Protection Agency for the periods specified above.
- I. **Coverage.** Warranty defects shall be remedied during customary business hours at any authorized Zuma Extreme Sports's dealer located within the United States of America in compliance with the Clean Air Act and applicable regulations of the United States Environmental Protection Agency. Any part or parts replaced under this warranty shall become the property of Zuma Extreme Sports.
- II. **Limitations** This Emission Control System Warranty shall not cover any of the following:
- A. Repair or replacement as a result of
- (1) accident,
 - (2) misuse,
 - (3) repairs improperly performed or replacements improperly installed,
 - (4) use of replacement parts or accessories not conforming to Zuma Extreme Sports's specifications which adversely affect performance and/or
 - (5) use in competitive racing or related events.
- B. Inspections, replacement of parts and other services and adjustments required for required maintenance.
- C. Any vehicle equipped with an odometer or hour meter on which the odometer mileage or hour meter reading has been changed so that actual mileage cannot be readily determined.
- III. **Limited Liability**
- A. The liability of Zuma Extreme Sports under this emission control system warranty is limited solely to the remedying of defects in material or workmanship by an authorized Zuma Extreme Sports's dealer at its place of business during customary business hours. This warranty does not cover inconvenience or loss of use of the vehicle or transportation of the vehicle to or from the Zuma Extreme Sports's dealer. Zuma Extreme Sports shall not be liable for any other expenses, loss or damage, whether direct, incidental, consequential or exemplary arising in connection with the sale or use of or inability to use the vehicle for any purpose. Some states do not allow the exclusion or limitation of any incidental or consequential damages, so the above limitations may not apply to you.
- B. No express emission control system warranty is given by us except as specifically set forth herein. Any emission control system warranty implied by law, including any warranty of merchantability or fitness for a particular purpose, is limited to the express emission control system warranty terms stated in this warranty. The foregoing statements of warranty are exclusive and in line of all other remedies. Some states do not allow limitations on how long an implied warranty lasts so the above limitations may not apply to you.
- C. No dealer is authorized to modify this Zuma Extreme Sports Limited Emission Control System Warranty.

EMISSION CONTROL SYSTEM WARRANTY

Below is the emission control system warranty printed in the owner's manual, the copy of the owner's manual is available upon your request.

YOUR WARRANTY RIGHTS AND OBLIGATIONS

The U.S. Environmental Protection Agency, and Zuma Extreme Sports Co.,Ltd. (hereinafter "Zuma Extreme Sports") are pleased to explain the emission control system warranty on your 2021 Model Year OFMC. New vehicle must be designed, built and equipped to meet U.S. EPA Federal over the full useful life. Zuma Extreme Sports must warrant the emission control system on your vehicle for 5,000 km or for 30 months, whichever comes first, provided that there has been no abuse, neglect or improper maintenance of your vehicle.

Your emission control system may include parts such as the carburetor or fuel injection system, the ignition system, catalytic converter and engine computer, if it is equipped. Also included may be hoses, belts, connectors and other emission-related assemblies.

Where a warrantable condition exists, Zuma Extreme Sports will repair your vehicle at no cost to you, including diagnosis, parts and labor.

If an emission-related part on your vehicle is defective, the part will be repaired or replaced by Zuma Extreme Sports. This is your emission control system defects warranty.

NOTICE! Use of any Zuma Extreme Sports vehicles in any type of competitive event completely and absolutely voids this and all other warranties offered by Zuma Extreme Sports.

OWNER'S WARRANTY RESPONSIBILITIES

As the vehicle owner, you are responsible for the performance of the required maintenance listed in your owner's manual. Zuma Extreme Sports recommends that you retain all receipts covering maintenance on your vehicle, but Zuma Extreme Sports cannot deny warranty solely for the lack of receipts or for your failure to ensure the performance of all scheduled maintenance.

You are responsible for presenting your vehicle to the Zuma Extreme Sports's dealer as soon as a problem exists. The warranty repairs should be completed in a reasonable amount of time, not to exceed 30 days.

As the vehicle owner, you should be aware that Zuma Extreme Sports may deny your warranty coverage if your vehicle or a part has failed due to abuse, neglect, improper maintenance or unapproved modifications.

If you use your vehicle in any type of sanctioned competitive event, this warranty is immediately and completely void.

If you have any questions regarding your warranty rights and responsibilities, you should contact Zuma Extreme Sports Co.,Ltd., 1942 Broadway St.STE 314C,Boulder,CO 80302,TEL: 866-991-2128

Zuma Extreme Sports warrants that each new 2021 and later Zuma Extreme Sports's OFMC:

A. is designed, built and equipped so as to conform at the time of initial retail purchase with all

INTRODUCTION

Congratulations on choosing your off-road motorcycle.

Your dirt bike was designed as a recreational motorcycle for off-road use only by a single rider only. This motorcycle is ideal for riders with basic experience.

Before riding, take plenty of time to get acquainted with your motorcycle and how it works. To protect your investment, we urge you to keep your motorcycle well maintained. In addition to regular maintenance, it is just as important to observe and perform all pre-ride and periodic checks detailed in this manual. We also recommend that you read this manual before you begin riding. In this manual you will find safety information, facts, instructions, helpful tips and illustrations. To make it easy to use, the manual contains a table of contents at the beginning of the manual.

As you read through this manual, you will find information that is preceded by a **NOTICE** symbol. This information is intended to help you avoid damage to your motorcycle and/or property around you. This manual covers basic maintenance procedures. A detailed parts diagram manual is available, and it can be purchased separately from us. The parts manual will be helpful to those with the mechanical skills and tools required to service their own motorcycle.

Whenever you ride, tread lightly. By staying on established trails and riding in approved areas, you will help protect the environment and keep off-road riding areas open for future use.

If you have any questions or you need any special service or repair, remember that your dealer knows your motorcycle best and will be dedicated to your complete satisfaction. Replacement parts and technical support can be obtained through your dealer. Please be sure to register your motorcycle with us and report any address changes so that we may contact you in the future concerning important product information.

EPA OFF - ROAD MOTORCYCLE SPECIFICATIONS

S5-150 SPECIFICATIONS-STORM 150

Vehicle	Off-Road Motorcycle	Model	S5-150
Fuel Type(s)	Gasoline	Dimension(mm)(LXWxH)	1930*750*1070mm
Engine Type	4-Stroke, 1-cylinder,Oil Cooled	Wheel Base(mm)	1340mm
Engine Displacement(s)	150 CC	Ground Clearance(mm)	320mm
Bore x Stroke	56.5x56 mm	Seat Height(mm)	890mm
Max Power	6.8/7500 kw/t/min	Max load(kg)	100KG5
Max Torque	11.0/5500 N.m/r/min	Tire Size(Front/Rear)	70/100-19 & 90/100-16
Compression Ratio	9.0:1	Wheel Rim(Front/Rear)	Steel& Steel ;Or Alloy & Alloy
Shift Type	Manual, N-1-2-3-4, 4-Gears	Brake(Front/Rear)	Disc / Disc
Ignition Mode	CDI	Rear Brake Operation	Foot
Spark Plug	TORCH-A7TC	Starting	Kick start & Electric Start
Min.Fuel Consumption	≤367g/(kW·h)	Battery Capacity	12V4A

S5-150 SPECIFICATIONS-STORM 150 DLX

Vehicle	Off-Road Motorcycle	Model	S5-150
Fuel Type(s)	Gasoline	Dimension(mm)(LXWxH)	1930*800*1260mm
Engine Type	4-Stroke, 1-cylinder,Oil Cooled	Wheel Base(mm)	1340mm
Engine Displacement(s)	150 CC	Ground Clearance(mm)	320mm
Bore x Stroke	56.5x58 mm	Seat Height(mm)	890mm
Max Power	6.8/7500 kw/t/min	Max load(kg)	100KG5
Max Torque	11.0/5500 N.m/r/min	Tire Size(Front/Rear)	70/100-19 & 90/100-16
Compression Ratio	9.0:1	Wheel Rim(Front/Rear)	Steel& Steel ;Or Alloy & Alloy
Shift Type	Manual, N-1-2-3-4, 4-Gears	Brake(Front/Rear)	Disc / Disc
Ignition Mode	CDI	Rear Brake Operation	Foot
Spark Plug	TORCH-A7TC	Starting	Kick start & Electric Start
Min.Fuel Consumption	≤367g/(kW·h)	Battery Capacity	12V4A

MAINTENANCE SCHEDULE

Below is the actual copy of the maintenance schedule from the owner's manual, the copy of the owner's manual is available upon your request.

Items	Frequency	Month/Distance						
		1month/300km	6months/1000km	12months/2000km	18months/4000km	24months/5000km	36months/8000km	
• Fuel Line		I						
• Fuel Filter			I	R	I	R	I	
• Throttle Operation			I		I		I	
• Air Filter			C	C	C	C	C	
• Spark Plug			I		I		I	
• Engine Oil	R	R						
• Engine Oil Speed		I	I	I	I	I	I	
• Drive Chain								
			Inspect & Lubricate every three months or 300 miles					
• Drive Chain Sizer		I	I	I	I	I	I	
• Brake Pad Wear		I	I	I	I	I	I	
• Brake System		I	I	I	I	I	I	
• Clutch System		I	I	I	I	I	I	
• Side Stand		I	I	I	I	I	I	
• Suspension		I	I	I	I	I	I	
• Spark Arrestor			C	C	C	C	C	
• Nuts, Bolts, Fasteners		I	I	I	I	I	I	
• Wheels & Tires		I	I	I	I	I	I	
• Steering Head Bearings		I	I	I	I	I	I	
• Oil Filter	R	R	R	R	R	R	R	

Maintenance Procedures: I=Inspect (Clean, Adjust or Replace if needed), C=Clean, A=Adjust, L=Lubricate, R=Replace.

WIRING DIAGRAM

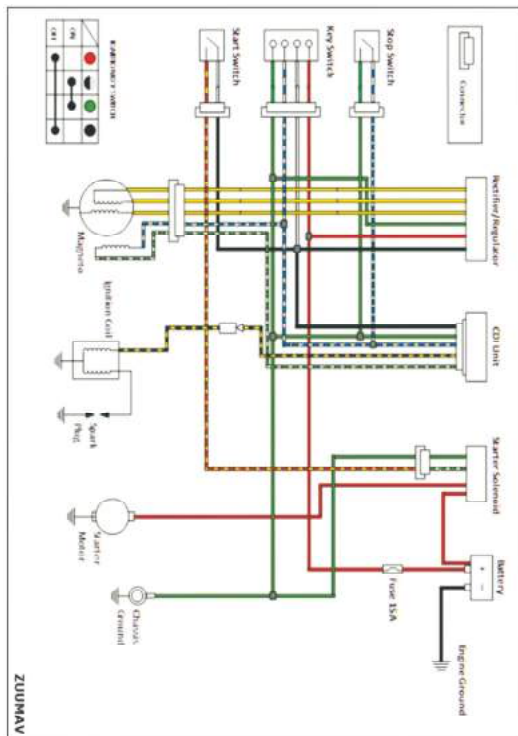

IMPORTANT SAFETY INFORMATION

Your personal safety, and the safety of those around you, is extremely important. Operating this motorcycle safely is an important responsibility. We have provided operating procedures and other information on labels and in this manual to help you make informed decisions about safety. This information will alert you to potential hazards that could harm you or others.

It is understood that it is not practical or possible to warn you about all possible hazards associated with operating and maintaining a motorcycle. You must use your own good judgment.

Safety information will come in a variety of different forms, including:

- ❖ Safety Labels on the Motorcycle.
- ❖ Safety Messages preceded by a safety symbol ▲ and one of these signal words:

Below are the definitions of these three words:

▲ DANGER You WILL be KILLED or SERIOUSLY INJURED if you do not follow instructions.

▲ WARNING You CAN be KILLED or SERIOUSLY INJURED if you do not follow instructions.

▲ CAUTION You CAN be INJURED if you do not follow instructions.

- ❖ Safety Headings such as important safety reminders and/or precautions.
- ❖ Safety Section such as motorcycle safety.
- ❖ Instructions how to use the motorcycle safely and correctly.

This entire manual is filled with important safety information - please read it carefully.

IMPORTANT SAFETY INFORMATION

A motorcycle can provide many years of service and pleasure, provided you take responsibility for safety, properly maintain your motorcycle and understand the challenges you may encounter while riding.

This motorcycle has been designed for younger riders. However, not all youngsters meet the physical and emotional levels that are needed for riding. Before parents allow any children to ride this motorcycle, we strongly recommend that they read this entire manual so that they are fully informed before deciding if their children are ready to ride. Listed below are some of the most important safety measures one should take when riding.

⚠ DANGER **Never Ride Without a Helmet.** The following statement is a proven fact: "Helmets significantly reduce the number and severity of head injuries." Never ride your motorcycle without a helmet. Even a crash at slow speed can result in a fatal head injury if you are not wearing a helmet. We recommend wearing helmets that have been certified for safety by helmet testing organizations that are independent from the helmet manufacturer. We also recommend that you wear eye protection, boots, gloves, and other protective gear such as off-road riding pants.

⚠ WARNING **Never Carry a Passenger.** This motorcycle has been designed for ONE rider only. There are no passenger pegs, footrests, handles or seat room for a passenger. Riding with a passenger can interfere with your ability to operate and control the motorcycle and may result in serious injury or death.

⚠ WARNING **Ride Off-Road Only.** This motorcycle has been designed and manufactured for off-road use only. The motorcycle is not equipped with lights, turn signals, horn and other features required to drive a motorcycle on public roads. The tires are not designed for pavement and will make the motorcycle unstable if it is ridden on pavement. If you must cross a paved road, dismount and walk the motorcycle across the road.

⚠ WARNING **Ride Within Your Limits.** Never attempt to ride your motorcycle in a manner that is beyond your skill level. It takes time to learn off-road riding skills. Learn to ride your motorcycle step by step. Start by practicing on safe terrain at slow speeds and gradually build your skill level. Instruction from an experienced rider(s) is highly recommended. Remember that alcohol, drug use, fatigue and ignorance can reduce your ability to make good decisions and ride safely.

⚠ WARNING **Be Alert for Hazards.** The terrain in which you ride can present many hazards. Always "scan" the terrain ahead of you continually. Watch for un-expected turns, drop-offs, ditches, rocks and other hazards. Always maintain a speed slow enough to allow you enough time to see and react to hazards.

⚠ DANGER **Do Not Drink and Ride.** Even one drink can impair your ability to ride a motorcycle safely. Each drink afterward will make the impairment worse. Do not drink and ride. Do not let your friend's drink and ride. Remember, in most states throughout the United States, you can be arrested and charged with Driving Under the Influence (DUI) if you are riding a motorcycle while intoxicated. This applies to off-road motorcycles as well.

RESOLVING THE UNEXPECTED

IF YOU HAVE A FLAT TIRE

How you handle a flat tire on the trail will depend on the severity of the damage to the tire and/or the inner tube and what tools and supplies you keep with you. If you have a slow leak or a minor puncture, there are two ways you can try to make a temporary repair:

1. Use an aerosol tire sealer to seal the puncture and inflate the tube. You can do this without removing the wheel.
2. Use a tube repair kit to patch the hole in the inner tube. This requires removal of the wheel and tire.

If the leak is more severe, or a temporary repair does not hold up, you will need to replace the inner tube. If the tire is also severely damaged, you will need to replace the tire as well.

If you cannot repair the flat tire on the trail, you will need to push the motorcycle back to your base or send for help. Do not ride on a flat tire. The motorcycle will be hard to handle, and if the tire comes off the rim, it can lock up the wheel and cause you to crash.

IF YOU CRASH

Personal safety is the first priority after an accident. If you or anyone else has been injured, take plenty of time to assess the severity of the injuries and determine if it is safe to continue riding. If you cannot ride safely, send someone for help. Do not ride if you will risk further injury or if your motorcycle has been damaged too severely.

If you decide you are capable of riding safely, carefully inspect the motorcycle for damage. Check the tightness of critical nuts and bolts such as the handle bars, control levers, brakes and wheels. If there is minor damage, or you are not sure about possible damage but decide to ride back to your base, ride slowly and cautiously.

Sometimes crash damage is hidden or not immediately apparent. Once you get home, go over your motorcycle thoroughly and fix any problems that you find. Also, be sure to have your Zoumav dealer inspect the frame and suspension after a serious crash.

IF A COMPONENT FAILS

The drive chain, master link, control cables, brake controls, and other components can be damaged if you ride in dense brush or over rocky terrain. As mentioned earlier, making the repair on the trail will depend on the severity of the damage, tools, supplies, and skills that you have.

If the drive chain comes off because the master link clip has been knocked off, you may be able to repair the chain with a new master link. However, if the chain is broken or causes damage when it comes off, you may not be able to make a trailside repair.

If any component of the front braking system is damaged, you may be able to ride back to your base carefully using the rear brake for slowing and stopping. Likewise, if a component of the rear braking system fails, you can use the front brake for slowing and stopping.

If you damage the throttle cable or some other critical component, the motorcycle may be unsafe to ride. Carefully assess the damage and make any repairs that you can. But if you have any doubts, it is best to be conservative and safe.

RESOLVING THE UNEXPECTED

GENERAL GUIDELINES

If you encounter trouble during a ride, the first thing you should do is stop as soon as it is safely possible. Do not continue to ride if you have a flat tire, if you hear an unusual noise, or if your motorcycle just does not feel right. If you continue to ride, you will cause more damage to the motorcycle and endanger your own safety.

After you stop, take time to carefully look over your motorcycle and identify the problem. Always consider all of your options before you make a decision. Sometimes a problem can be relatively minor and can be permanently repaired on the trail provided you have the tools, supplies and skills needed to do so. In addition, you may be able to make a temporary repair and ride slowly back to your base where you can get further help and/or supplies.

When a problem appears to be more serious; or you do not have the tools, supplies and skills needed to make a repair, you will need to choose a safe way to get yourself and the motorcycle back to your base. If you are close enough, you can often push the motorcycle back.

Whatever the problem may be, always follow the instructions below:

1. Always put safety first.
 2. If the problem is minor and you have the tools, supplies and skills needed to make a temporary repair, be sure to make permanent repairs as soon as possible.
 3. Do not continue riding if you are hurt or if your motorcycle is not in safe riding condition.
- Recommendations for specific problems follow.

IF THE ENGINE QUITS or WILL NOT START

If the engine was not making unusual noises before it quit running, and it feels normal when you operate the kick starter, you can probably rule out a major mechanical problem.

First, check the fuel system:

1. Make sure you have fuel in the gas tank and the fuel valve is set to the "ON" position.
2. Check the fuel tank cap breather hose to be sure it is not pinched or clogged.
3. Turn the fuel valve to the "OFF" position. Disconnect the fuel line from the carburetor and momentarily turn the fuel valve to "ON". If fuel does not flow out, there is an obstruction in the fuel tank, fuel filter, or in the fuel line.

If the fuel system appears to be okay, check the ignition system.

1. Check the spark plug cap. Be sure that it is not loose or disconnected.
2. Disconnect the spark plug cap and remove the spark plug. Connect the spark plug to the plug cap and place the threaded end of the spark plug on a metal part of the engine.
3. Kick the kick starter while you watch the spark plug. If it sparks, the ignition system is probably working. If there is no spark, replace the spark plug with a new one. If there is still no spark, there is a problem with the ignition system.

If you cannot identify or correct a problem, you will have to push your motorcycle back to your base or get some help.

IMPORTANT SAFETY INFORMATION FOR PARENTS

As a parent, your child's safety is your first priority. Riding an off-road motorcycle is very fun. However, just like riding a bicycle, bad decisions can result in injury. As a parent, you can greatly prevent accidents by making informed decisions about if, when and how your child will ride. Always supervise your child when he/she is riding.

Before you allow your child to ride, you need to decide if he/she is capable of riding. Riding readiness can vary tremendously from one person to another. Age and size are not being the only factors that help determine one's riding readiness. There are three other factors that you should also consider before deciding if your child is ready to ride.

First, consider the **physical ability** of your child. Riders must be able to hold the motorcycle up, get on, and sit comfortably with both feet on the ground. The rider must also be able to reach all of the controls on the handlebars and work the brakes and clutch. Second, consider your child's **athletic ability**. Your child should be good at riding a bicycle before riding a motorcycle. Determine if your child can judge speeds and distances while riding a bicycle and react with the proper hand and foot actions. Any person who does not have good coordination, balance, and agility should not ride this motorcycle.

Finally, determine your child's level of **mental maturity**. It is imperative that you are honest with yourself when you ask yourself the following questions: Does your child think through problems and come to logical conclusions? Does your child obey your rules when they ride their bicycle? If your child makes bad judgments, takes un-warranted risks and/or does not obey your rules, they should not ride this motorcycle.

If you have decided that your child is ready to ride, please remember the following points and never let your child ride without a helmet. It is up to you (parent) to ensure your child's safety, even if they learn to ride from another experienced adult. Never push your child to try things faster than they are willing or capable. Always supervise your child when they are riding and regularly remind them about safety rules. As a parent it is your responsibility to be sure that the motorcycle is properly maintained and kept in safe operating condition.

Modifying this motorcycle or using parts not manufactured by Znuumav can make your motorcycle unsafe. Before you consider making any modifications or adding an accessory, please read the following information carefully.

⚠ WARNING Improper accessories or modifications can cause a crash in which you can be seriously hurt or killed. Follow all instructions in this owner's manual regarding modifications and accessories.

We strongly recommend that you do not remove any original equipment or modify your motorcycle in any way that may alter the design and/or operation. Such a change could drastically impair the stability, handling, acceleration, and braking capabilities of the motorcycle and cause a crash. We also strongly suggest that you do not make any modifications to the exhaust system components.

125CC MOTORCYCLE SAFETY LABEL INFORMATIONS

This page will show you where to find the safety labels on your motorcycle. You will find that some labels warn you of potential hazards. Others will provide important safety and maintenance information. Please read them carefully and do not remove them. If your label wears off from riding or becomes hard to read, contact your dealer for a replacement.



TROUBLESHOOTING

POOR HANDLING

Steering is Heavy

- Steering stem nut is too tight
- Damaged steering head bearings
- Check tire pressure

Either Wheel Has a Wobble

- Excessive wheel bearing play
- Bent rim
- Improperly installed wheel hub
- Bent frame
- Loose or broken spokes
- Old tires with "dry-rot"
- Damaged swing-arm

The motorcycle pulls to one side

- Front and rear wheels out of alignment
- Damaged upper or lower triple clamp
- Damaged or bent fork(s)
- Bent swing-arm
- Bent frame
- Damaged or bent axle shaft

TROUBLESHOOTING

4. **Ignition Timing Inspection** – See your local Zuumav dealer or local motorcycle repair shop to have the ignition timing inspected. Only attempt these procedures if you are qualified and have the proper tools required.

Is the ignition timing normal? (Timing is not adjustable)

NO - Faulty CDI ignition box

- Faulty ignition pulse generator

YES - See your local Zuumav dealer to have your motorcycle serviced.

POOR PERFORMANCE at HIGH SPEED

1. **Examine the Fuel Line** – Disconnect the fuel hose at the carburetor.

Is the fuel flowing freely?

NO - Clogged fuel hose/line or clogged fuel filter

- Clogged fuel valve

- Clogged fuel tank breather hose

YES - Go to STEP 2

2. **Carburetor Inspection** – Disassemble the carburetor and check for clogs

Is the carburetor clogged and/or dirty?

NO - Go to Step 3

YES - Carburetor is not serviced frequently enough, contaminated fuel

3. **Ignition Timing & Valve Train inspection** – See your local Zuumav dealer or motorcycle repair shop to have the ignition timing inspected. Only attempt these procedures if you are qualified and have the proper tools required.

Is the ignition timing, valve timing and valve springs normal? (Timing is non-adjustable)

NO - Faulty CDI ignition box

- Faulty ignition pulse generator

- Broken valve spring

- Broken or damaged camshaft sprocket

YES - See your local Zuumav dealer to have your motorcycle serviced.

SAFETY LABEL INFORMATION



150CC STORM PHOTOS



Oil cooler



Oil cooler

TROUBLESHOOTING

12. **Lubrication Inspection** – Remove the valve adjustment covers on the cylinder head and inspect the system for lubrication.

Is the valve train being lubricated properly?

- NO** - Clogged oil passage (see your local Zuumav dealer)
- Dirty and/or contaminated engine oil

YES - See your local Zuumav dealer to have your motorcycle serviced.

POOR PERFORMANCE at IDLE and LOW SPEED

1. **Intake Manifold Inspection** – Check the intake manifold seals for leaks.

Is there a leak in the manifold?

NO - Go to STEP 2

- YES** - Loose carburetor mounting bolt (nuts)
- Damaged, cracked insulator/spacer
- Damaged intake manifold gasket
- Damaged O-ring seal
- Cracked or broken intake manifold (pipe)

2. **Spark Test** – Test for ignition spark by removing the spark plug and using a spark tester found at your local auto shop or by inserting it into the spark plug cap. Place the open end of the spark plug on a metal part of the engine and kick start the engine or use the electric start. You should see a nice blue spark on the end of the spark plug. A faint spark will not start the engine.

Is there a good spark?

NO - Fouled or faulty spark plug

- Broken or shorted spark plug wire or spark plug cap.
- Broken or shorted ignition coil
- Faulty ignition CDI box
- Faulty or shorted magneto assembly
- Broken or shorted engine stop switch
- Loose or corroded wires and/or connectors (always clean bad electrical connections)

YES - Go to STEP 3

3. **Carburetor Air/Fuel Mixture Screw Inspection** – Check the carburetor air/fuel mixture screw. Turn the screw clockwise until you feel it stop. DO NOT TIGHTEN! Back out the screw counter-clockwise 1.5 full turns.

Is the screw setting correct?

- NO** - Adjust using the above procedure or see your local Zuumav dealer

YES - Go to STEP 4

TROUBLESHOOTING

6. **Engine Oil Inspection** – Check the oil level and the condition of the oil.
Is the engine oil level correct and in clean condition?
NO - Oil level too high
- Oil level too low
- Contaminated oil
YES - Go to STEP 7
7. **Cylinder Compression Inspection** – Check the cylinder compression
Is the engine compression normal?
NO - Valve stuck open/seized or improper valve timing (see your local Zuumav dealer)
- Worn cylinder wall and/or piston rings (see your local Zuumav dealer)
- Leaking or damaged head gasket (see your local Zuumav dealer)
YES - Go to STEP 8
8. **Carburetor Inspection** – Disassemble the carburetor and check for clogs
Was the carburetor clogged and/or dirty?
NO - Go to STEP 9
YES - Carburetor is not serviced frequently enough
- Contaminated fuel
9. **Over Heating Inspection** – Check the engine for overheating.
Is the engine overheating?
NO - Go to STEP 10
YES - Excessive carbon buildup in the combustion chamber
- Use of poor quality oil
- Clutch slipping
- Lean fuel mixture or improper octane rating of fuel
10. **Engine Condition Inspection** – Accelerate rapidly through all gears and ride at high speed
Does the engine knock?
NO - Go to STEP 11
YES - Worn piston and cylinder (See your local Zuumav dealer)
- Wrong type of fuel (octane rating)
- Lean fuel mixture
- Excessive carbon buildup on the combustion chamber
11. **Ignition Timing Inspection** – Only attempt these procedures if you are qualified and have the proper tools needed. Otherwise, see your local Zuumav dealer or a motorcycle repair shop to have the ignition timing and engine lubrication system inspected.
Is the ignition timing normal? (Timing is non-adjustable)
NO - Faulty CDI ignition box
- Faulty ignition pulse generator
YES - Go to STEP 12

150CC STORM DLX PHOTOS



Oil cooler



Oil cooler

COMPONENT LOCATIONS

When you ride a motorcycle off-road, you need to be able to operate the throttle, clutch, brakes, and motorcycle. This section of the manual will describe the function, location, and operation of all the basic controls of your motorcycle.



TROUBLESHOOTING

ENGINE LACKS POWER

- 1. Examine the Drive Train** – Raise the wheel off the ground and spin by hand.
Does the wheel spin freely?
NO - Brake dragging, improperly mounted brake pads
- Worn or damaged wheel bearings
- Bent Axle
YES - Go to STEP 2
- 2. Check the Tire Pressure** – use a tire pressure gauge to check the tire pressure of each tire.
Is the tire pressure correct?
NO - Punctured tire and/or inner tube
- Faulty tire valve
YES - Go to STEP 3
- 3. Clutch Inspection** – Accelerate rapidly through first and second gears.
Does the engine RPM/speed decrease properly when you shift from first gear to second gear?
NO - Slipping clutch, adjustment needed
- Worn out clutch discs and/or plates
- Weak clutch springs
- Contaminating additive in the engine oil
YES - Go to STEP 4
- 4. Engine Performance Inspection** – Accelerate lightly.
Does the engine speed increase?
NO - Clogged air filter
- Restricted or clogged fuel line and/or fuel filter
- Clogged muffler/spark arrester
- Choke valve is closed
- Clogged fuel tank breather hose
YES - Go to STEP 5
- 5. Spark Plug Inspection** – Remove the spark plug and inspect
Is the spark plug in good working condition?
NO - Spark plug is not serviced frequently enough
- Incorrect spark plug heat range
- Incorrect spark plug gap
YES - Go to STEP 6

TROUBLESHOOTING

5. **Engine Start Condition** – Start the engine by using the normal starting procedure:
Does the engine start but then quickly stops afterward?
YES - Improper choke operation
- Dirty or improperly adjusted carburetor (Contact your local Zuumav dealer)
- Intake manifold/pipe leak
- Improper ignition timing (see your local Zuumav dealer)
- Dirty or contaminated gasoline.

COMPONENT LOCATIONS

SERIAL NUMBER LOCATIONS

VIN – Chassis Number

The VIN number is located on the neck of the chassis.
1. Right or left side of frame.
Write this number in the VIN box on page 3.



Engine Model & Serial Number

The engine model number and serial numbers are stamped on the left side of the engine under the engine sprocket cover.
Write this number in the Engine Number box on page 3.



HANDLEBAR LEVER CONTROLS

Clutch Lever

The clutch lever ① is located on the left side of the handlebar.



Hand Brake Lever & Throttle

The hand brake lever ② and throttle ③ are mounted on the right side of the handlebar.

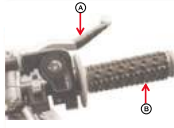

Stop Switch

The stop (kill) switch ④ turn off the engine. When this button is pressed, the ignition circuit is turned off.



Start Switch (Electric Start Engine)

The start switch ⑤ turns on the engine. When this button is pressed, the electric starter will engage to start the engine. Once started, release the button.



OPERATING CONTROLS

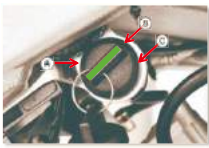

Key Switch (No Steering Lock)

The ignition key **A** is used to supply power from the battery to the electrical components of the motorcycle. Turn the switch to the "OFF" position **B** when you are finished riding, or if you wish to stop the engine.
B OFF position
C ON position

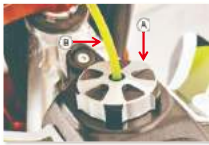

Fuel Filler Cap

To Open: Turn the cap **A** counter-clockwise.
To Close: Turn the cap clockwise, make sure the breather tube **B** is installed.



Gear Shift Lever

The gear shift lever **A** is on the left side of the engine. The gear positions are shown in the illustration on the left. (variable shift pattern, depending on your engine. Check decal affixed on the engine.)



Foot Brake Lever (Rear Brake)

The rear brake lever **A** is located on the right side of the engine near the foot rest. Its basic operation is to apply the rear brake (press down slowly) to slow or stop the motorcycle.

TROUBLESHOOTING

ENGINE DOES NOT START or IS HARD TO START

1. **Examine the Carburetor** – Be sure there is fuel flowing into the carburetor:

Is there fuel flowing into the carburetor?

- NO** - Clogged fuel hose/line or clogged fuel filter
- Clogged fuel valve
 - Clogged fuel tank breather hose
 - Sticking or stuck carburetor float.
- YES** - Go to STEP 2.

NOTICE
 DO NOT TOUCH THE SPARK PLUG OR PLUG CAP WHILE TRYING TO START THE ENGINE. YOU WILL RECEIVE AN ELECTRICAL SHOCK WHICH COULD RESULT IN SERIOUS INJURY OR DEATH.

2. **Examine the Spark Plug** – Remove the spark plug and inspect

Is the spark plug in good condition?

- NO** - Flooded engine and/or carburetor
- Choke valve is closed
 - Throttle is stuck in the open position
 - Dirty or clogged air filter
 - Excessively worn piston rings (See your Zuumav dealer)
- YES** - Go to STEP 3.

3. **Spark Plug** – Test for ignition spark by removing the spark plug and using a spark tester found at your local auto shop or by inserting it into the spark plug cap. Place the open end of the spark plug on a metal part of the engine and kick start the engine or use the electric start. You should see a nice blue spark on the end of the spark plug. A faint spark will not start the engine.

Is there a good spark?

- NO** - Fouled or faulty spark plug
- Broken or shorted spark plug wire or spark plug cap.
 - Broken or shorted ignition coil
 - Faulty ignition CDI box
 - Faulty or shorted magneto assembly
 - Broken or shorted engine stop switch
 - Loose or corroded wires and/or connectors (always clean bad electrical connections)
- YES** - Go to STEP 4

4. **Cylinder Compression Test** – Perform a simple compression test by kick starting the engine slowly.

Be sure you have the spark plug installed. While pushing down on the kick starter slowly, you should feel a very hard firmness that will abruptly soften as the kick start lever moves further down. No hard firmness in the kick start lever means you have poor compression. Is the compression normal?

- NO** - Valve stuck open/seized or improper valve timing (see your local Zuumav dealer)
- Worn cylinder wall and/or piston rings (see your local Zuumav dealer)
 - Leaking or damaged cylinder head gasket (see your local Zuumav dealer)
- YES** - Go To Step 5

BASIC MAINTENANCE PROCEDURES

If you have been riding in extremely muddy or dusty conditions, the drive chain should be removed and cleaned before you apply lubricant. Follow the procedure below to remove and clean or replace the drive chain with a new one.

CHAIN REMOVAL, CLEANING & REPLACEMENT



1. Remove the chain master link retaining clip with needle nose pliers. Do not bend or twist the clip. Remove the master link and remove the drive chain.
2. Clean the drive chain with a non-flammable solvent such as kerosene – NOT gasoline – and allow it to dry.
3. Inspect the drive chain for possible wear or damage. Replace the drive chain if it has any damaged rollers, loose fitting links or otherwise appears unserviceable.
4. Inspect the sprockets for wear or damage. Zuumav recommends that you replace the sprockets when you install a new drive chain.
5. Pass the chain over the sprockets and join the ends of the chain with the master link. For ease of assembly, hold the chain ends against adjacent rear sprocket teeth while inserting the master link. Install the master link retaining clip so that the closed end of the clip will face the direction of the forward wheel rotation.
6. Don't forget to lubricate the chain thoroughly.

The master link is the most critical element of drive chain security. Master links are reusable, if they are in excellent condition. We recommend installing a new master link when you install a new drive chain. You may find it easier to install a new chain by connecting it to the old chain using a master link and pulling the old chain to position the new chain on the sprockets.

APPEARANCE CARE

To clean the motorcycle, you can use any of the following: water, mild neutral detergents, mild spray and wipe cleaners, mild spray and rinse cleaners/degreasers. Avoid products that contain harsh detergents or chemical solvents that can damage the metal, paint and plastic on your motorcycle.

We recommend that you use a garden hose to wash your motorcycle. High pressure washers (like coin operated car washers) can damage certain parts of the motorcycle. If you must use a high-pressure washer, avoid spraying the following areas: Wheel hubs, muffler outlet, underneath the seat, engine stop switch, underneath the gas tank, drive chain and carburetor.

NOTICE

HIGH PRESSURE WATER OR AIR CAN DAMAGE CERTAIN PARTS OF THE MOTORCYCLE. NEVER WASH THE MOTORCYCLE WHILE THE ENGINE IS RUNNING. ALWAYS LUBRICATE THE DRIVE CHAIN AFTER YOU ARE FINISHED WASHING AND THE MOTORCYCLE IS DRY.

OPERATING CONTROLS

Kick Start Lever

The kick start lever **A** is mounted on the right side of the engine. It is used to start the engine in case the electrical starter system is non-functional.



Side (Kick) Stand

Push the side stand **A** to the ground and tilt the motorcycle to the left. Make sure the motorcycle is on solid ground and the position is secure.

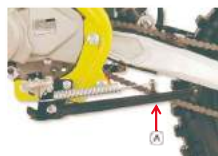

Fuel Tap

OFF – In this position, the fuel tap is closed. No fuel can flow to the carburetor. **Fig. 1**
ON – In this position, the fuel tap is open. Fuel can flow to the carburetor. With the tap in this position, the tank will be emptied. **Fig. 2**



Fig. 1

Fig. 2

BEFORE RIDING

Before you ride, you must be absolutely sure that you and your motorcycle are ready to ride. To help you get prepared, this section of the manual will discuss how to evaluate your riding readiness and how to perform our recommended pre-ride inspection of your motorcycle. If you are a parent, please be sure you have read the section "Important Safety Information for Parents" on page 9.

Are You Ready to Ride?

Before you ride your motorcycle for the first time, we strongly recommend the following:

1. Completely read this manual.
2. Be sure you have read and understand all the safety messages and labels.
3. You know how to operate all, of the motorcycle's controls.

Before each ride, we strongly recommend that you:

1. Are in good physical and mental condition.
2. Are free of alcohol and other drugs.
3. Are wearing an approved motorcycle helmet with a tight chin strap, eye protection and other protective clothing.

PROTECTIVE GEAR & APPAREL

For your safety, we strongly recommend that you always wear an approved helmet, eye protection, boots, gloves, long pants and a long sleeved, jersey shirt or jacket whenever you ride. Although complete protection is not possible, wearing the proper gear can reduce the chance of and severity of injuries when you ride.

Helmets & Eye Protection – Your helmet is your most important piece of riding gear because it offers the best protection against head injuries. A good helmet will be approved by a testing organization independent of the helmet manufacturer and will have a chin strap that can be tightened securely. Open-face helmets offer some protection, but a full-face helmet offers the most protection. When purchasing a helmet, regardless of style, look for DOT (Department of Transportation) sticker (USA only). If the helmet has been tested by an independent organization such as the Snell Institute, you will usually find their logo on a tag inside the padding of the helmet.

Additional Riding Gear – In addition to your helmet and eye protection, we also recommend:

1. Sturdy off-road motorcycle boots to help protect your feet, ankles and lower legs.
2. Off-Road motorcycle gloves to protect your hands.
3. Riding pants with knee and hip pads, a riding jersey with elbow pads and a chest/shoulder protector.

WARNING

NOT WEARING A HELMET INCREASES THE CHANCE OF SERIOUS INJURY OR DEATH IN A CRASH. BE SURE YOU ALWAYS WEAR YOUR HELMET AND OTHER PROTECTIVE APPAREL WHEN YOU RIDE.

BASIC MAINTENANCE PROCEDURES

Follow the procedure below to make adjustments to the drive chain slack. Be sure that you are parked on a level surface and the engine is turned OFF.

DRIVE CHAIN ADJUSTMENT

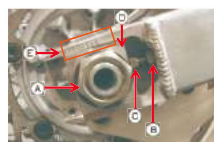

Fig. 1



Fig. 2

1. Loosen the rear axle nut **A**.
2. Loosen the adjuster lock nuts **B** on both the left and right side of the swing-arm.
3. Turn the adjusting bolts **C** counter-clockwise to decrease the slack or clockwise to increase the slack.
4. Align the marks **1** in Fig. 2 (if available) of the adjusting plate blocks **2** with the same reference marks **3** on both sides of the swing-arm.
5. Tighten the axle nut **4**.
6. Recheck the chain slack and adjust it if necessary.
7. If you chain slack is correct, turn the adjuster bolts counter-clockwise until they touch the axle plate blocks lightly.
8. Tighten the adjuster lock nuts while at the same time holding the adjuster bolts with a wrench.

CHAIN LUBRICATION



Commercially prepared chain lubricants may be purchased at many motorcycle shops and should be used instead of motor oil. Chain lube or gear oil (80w or 90w) is recommended. Saturate each joint so that the lubricant penetrates the space between each surface of the link plates and rollers.

BASIC MAINTENANCE PROCEDURES

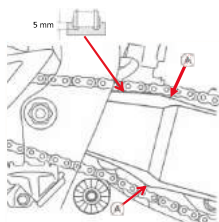

DRIVE CHAIN SLIDERS

1. Check the swing-arm chain slider **A** for wear and/or damage. Fig. 1
2. Replace the slider if falls below the limits indicated below:

Top Section: 5 mm

Bottom Section: 3 mm

3. Check the rear sprocket chain guide slider **B** for wear and/or damage. Fig. 2
4. Replace the slider if it's worn down to the bottom wear limit **C**.

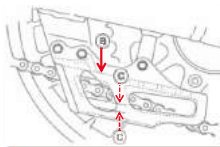

NOTICE
THE SLIDERS MUST BE REPLACED IF WORN DOWN TOO FAR.

IS THE MOTORCYCLE READY TO RIDE?

Before each, and every ride you take, it is extremely important that you inspect the motorcycle and make sure any problems you find are corrected. A pre-ride inspection is a must because off-road riding can be very tough on a motorcycle and you do not want to have a breakdown for from help.

WARNING

Improperly maintaining your motorcycle or failing to correct a problem before riding can cause a crash in which you can be seriously hurt or killed. Always perform a pre-ride inspection before any ride and correct any problems.

NOTICE TO PARENTS

If a youngster will be performing any of the following pre-ride inspection procedures, it is your responsibility to provide careful supervision and make sure they are performed safely.

PRE-RIDE INSPECTION

Check the following items before you get on the motorcycle:

Tires – Use a tire pressure gauge to check the air pressure. Inflate or deflate as needed. Also check for signs of damage or excessive wear.

Spokes & Rims – Make sure all of the spokes are tight. Inspect the rim to be sure it is not bent.

Leaks – Look under the motorcycle for signs of leaking fluids such as engine oil or gasoline.

Engine Oil – Check the level of engine oil and add if needed.

Fuel – Check the level of fuel in the gas tank. Add if needed. Be sure the gas cap is tightened securely.

Drive Chain – Inspect the drive chain condition and slack. Adjust and lubricate if needed. Also check the chain guide(s) and roller(s) for wear and replace if and when it is worn. For detailed instructions on drive chain slack adjustment, see the Servicing section of this manual.

Brake Hoses – Inspect the brake hoses for leaks and replace if needed.

Nuts & Bolts – Inspect all accessible nuts and bolts. Tighten then if it is needed.

Spark Plug & Cap – Check the spark plug for looseness. Tighten if needed. Be sure the cap is pushed on the spark plug and it is tight properly.

Check the following items after you get on the motorcycle:

Throttle – Check the throttle free-play and adjust if needed. Rotate the throttle to be sure it moves easily and freely. Make sure that it snaps back to its closed position automatically when you release it in all steering positions.

Brakes – Step on the rear brake lever and squeeze the front brake lever to be sure the brakes are working properly.

Remember, be sure to take care of any problems you find or have your Zoomax dealer correct it before you ride.

BASIC OPERATION & RIDING

This section of the manual gives basic information on how to begin riding your motorcycle. In this section we will cover how to start and stop the engine, how to use the throttle and brakes, how to use the clutch and shift gears, and things you need to do when you are finished riding.

To protect your new engine and enjoy optimum performance and service life, be sure to break-in your motorcycle properly. To do this, avoid full throttle starts and rapid acceleration for the first 35 miles (56 km) of riding.

SAFE RIDE PRECAUTIONS

Before riding this motorcycle, be sure you have read this entire manual up to this point including the section titled "Important Safety Information (Pg. 7, 8 & 9) & Before Riding".

Even if you have ridden other motorcycles in the past, take time to get familiar with the way the motorcycle works and handles. Always practice in a safe area until you have built your skill level to a point at which it is safe to ride.

CAUTION

For your safety, avoid starting or operating the motorcycle in an enclosed area with poor ventilation, such as a garage. The motorcycle's exhaust gas contains poisonous carbon monoxide which can collect rapidly in an enclosed area and result in illness or death.

WARNING

Your motorcycle is not equipped with lights. DO NOT ride at night.

STARTING & STOPPING THE ENGINE

Always follow the proper starting procedure as described below.

STARTING PROCEDURE (ELECTRIC START)

Starting When the Engine Is Cold

1. Turn the key switch to the "ON" position.
2. Make sure the transmission is in the neutral position.
3. Turn the fuel tap to the "ON" position.
4. Pull and hold the choke lever (depending on your model).
5. Lift the choke lever up.
6. Press and hold the brake lever on the right side of the handle bar.
7. Open the throttle no more than 1/4 of the way.
8. Press the start "yellow" (green) button until the engine starts.
9. Release the button as soon as the engine starts.
10. After about 1 minute after the engine starts, release the choke lever (depending on your model).
11. After about 1 minute after the engine starts, push the choke lever down.
12. Wait until the engine warms up for approximately 2-4 minutes. After the 2-4 minutes warm up, you are ready to go.

Starting When the Engine Is Warm

Repeat steps 1, 2, 3, 6, 7, and 8 in section "Starting when the engine is cold".

BASIC MAINTENANCE PROCEDURES

Use the diagram below to determine if the sprocket(s) need to be replaced. Never use a new chain with a damaged or worn sprocket.

NOTICE
THE USE OF A NEW CHAIN ON A WORN SPROCKET WILL CAUSE RAPID CHAIN WEAR.

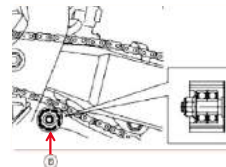
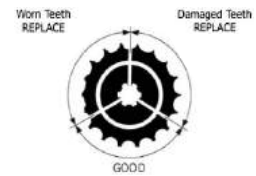

DRIVE CHAIN ROLLERS

1. Check the bottom **D** chain rollers for wear and/or damage. Measure the diameter of the drive chain rollers and replace it if it worn down, torn or broken.
2. Check the roller bearings to make sure they are not damaged, and they roll easily. If you feel any resistance while turning the bearing between your fingers, they must be replaced.
3. During installation of new rollers, clean the threads of the roller bolt and apply Loc-Tite 243 agent to the threads.
4. Tighten the roller bolt and/or nut.
5. Make sure they are tight and will not vibrate off.

BASIC MAINTENANCE PROCEDURES

The service life of your drive chain will depend on several factors including proper lubrication, adjustment, and riding style. If you are an experienced rider and tend to ride in a more intense manner, or you ride in muddy/dusty areas, you will need to check the drive chain more frequently. Poor maintenance will cause pre-mature wear and/or damage to the drive chain and sprockets.

Before you service your drive chain, be sure you are parked on a level surface and you turn the engine OFF. Be sure the transmission is in neutral. It is not necessary to remove or replace the chain to perform recommended maintenance service.

CHAIN INSPECTION



1. Check the slack in the lower drive chain midway between the sprockets (A). Push upward on the chain with your finger. The vertical movement should measure between 8-10mm
2. Repeat step 1 along several points of the drive chain. The slack should remain constant throughout. If it is not, some links may be kinked and binding. Lubricating the chain will often stop this from happening.
3. Inspect the drive chain for the following: damaged rollers, loose pins, dry or rusted links, kinked or binding links and excessive wear. Replace the chain, loose pins or kinks that cannot be fixed. Lubricate the drive chain if it appears dry or shows signs of rust. Lubricate any kinked or binding links and work them free.
4. You should replace the drive chain once the rear axle is moved as far back as possible and slack remains. This indicates that the chain is worn beyond its service limit.
5. Inspect the front and rear sprockets for excessive wear and/or damage. Refer to the illustration at the top of page 50. If needed, replace any worn or damaged sprocket(s). See your local Zumav dealer for assistance.

NOTICE

EXCESSIVE DRIVE CHAIN SLACK MAY ALLOW THE DRIVE CHAIN TO DAMAGE THE ENGINE CASE.

NOTICE

ALWAYS USE HIGH QUALITY LUBRICANT FOR THE DRIVE CHAIN

BASIC OPERATION & RIDING

STARTING PROCEDURE (KICK START)

Starting When the Engine Is Cold

1. Turn the key switch to the "ON" position.
2. Make sure the transmission is in the neutral position.
3. Turn the fuel tap to the "ON" position.
4. Pull and hold the choke lever (depending on your model).
5. Lift the choke lever up.
6. Press and hold the brake lever on the right side of the handle bar.
7. Open the throttle no more than 1/4 of the way.
8. Open the kick start lever and from the top of the kick starter stroke, kick through to the bottom with a rapid continuous motion.
9. After about 1 minute after the engine starts, release the choke lever (depending on your model).
10. After about 1 minute after the engine starts, push the choke lever down.
11. Wait until the engine warms up for approximately 2-4 minutes. After the 2-4 minutes warm up, you are ready to go.

Starting When the Engine Is Warm

1. Repeat steps 1, 2, 3, 6, 7, and 8 in section "Starting when the engine is cold"

FLOODED ENGINE

If the engine fails to start after repeated attempts, it may be flooded with excess fuel. Follow the steps below to clear a flooded engine.

1. Press the engine stop switch and hold it.
2. Open the throttle completely.
3. Press the engine start switch and hold it for 5 seconds. (Electric Start)
4. Kick start the engine several times. (Kick Start)
5. If necessary, remove the spark plug and let it dry.
6. Once the engine starts, open the throttle 1/4 for a few times.

STOPPING THE ENGINE

To stop the engine, shift into neutral and push the engine stop switch (A) on the left side of the handle bar.



CAUTION

DO NOT ride your motorcycle with full load and DO NOT rev up the engine when cold. Since the piston warms up and expands faster than the liquid cooled cylinder, this might cause engine damage. Always let the engine idle until warm or ride it warm at low RPM speeds.

CAUTION

For your safety, avoid starting or operating the motorcycle in an enclosed area with poor ventilation, such as a garage. The motorcycle's exhaust gas contains poisonous carbon monoxide which can collect rapidly in an enclosed area and result in illness or death.

SHIFTING GEARS

This motorcycle has five (4) (five (5)) forward gears.

- To start riding, after the engine has been warmed up and the side stand raised:
1. Close the throttle and squeeze the clutch lever all the way in.
 2. Depress the shift lever from neutral down to first gear. Once the transmission clicks into gear, the shift lever will return back to the neutral "N" position once you remove your foot.
 3. Slowly and gradually open the throttle and release the clutch lever in a simultaneous motion. When you feel the clutch begin to grab and the motorcycle starts to ease forward, you have reached the "friction zone" of the clutch. Gradually open the throttle more and release the clutch lever completely as the motorcycle moves forward.
 4. When you attain moderate speed, close the throttle and squeeze the clutch lever at the same time. Raise the shift lever until it clicks into second gear. After shifting, re-open the throttle and release the clutch lever.
 5. To continue shifting up to each higher gear, repeat step 4.
 6. To shift down to a lower gear, close the throttle and pull the clutch. Depress the shift lever until you feel it click into gear. After shifting, re-apply the throttle and release the clutch lever smoothly.

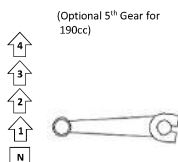

NOTICE

Remember to close the throttle before shifting gears. Improper shifting may damage the engine, transmission, and drive train.

Learning when to shift gears will come with riding experience. Up-shift into a higher gear when you hear the engine speed (rpm) get too high. When the engine rpm gets too high in a gear, you will feel the motorcycle stop accelerating. This is another way to know when to up-shift.

Downshift to a lower gear when you feel the engine lugging at a low rpm. Downshifting is usually done when you slow down for a turn or when you stop the motorcycle. Downshifting into a lower gear can help slow down your motorcycle, especially when going down-hill. However, down shifting when the engine rpm is too high can cause engine damage.

The neutral position of the transmission is located between the first and second gear positions. To shift into neutral, pull the clutch lever in and depress the shift lever as many times as needed to get into first gear. Once you are in first gear, pull up on the shift lever $\frac{1}{2}$ the distance required to up-shift into second gear. You can also shift into neutral from second gear by depressing the shift lever $\frac{1}{2}$ the distance required to downshift into first gear.

To prevent transmission damage, do not coast or tow the motorcycle for long distances with engine off.

WARNING

Never attempt to start the engine in gear. Doing so may cause a crash that could result in serious injury or death.

BASIC MAINTENANCE PROCEDURES

A flat tire or tire blowout can be very inconvenient and can even cause you to have an accident. Take the time to inspect your tires and wheels before you ride. For more information about handling a flat tire, refer to the section of this manual titled, [Resolving the Unexpected](#).

- Inspect the tire carefully for bumps or bulges in the sidewall of the tire and inside of the treads. Replace any tires that have bumps or bulges in them.
- Look closely for cuts, slits or cracks in the tires. Replace any tire if you can see a fabric or cord showing through.
- Check for rocks or other objects embedded in the tires or tread. Remove any foreign objects. Be sure there are no screws or nails in the tires.
- Measure the tread depth of the tires. Replace all tires before the tread depth gets below 0.12in (3mm) or anytime you notice a reduction in your traction.
- Check the position of both valve stems. A tilted valve stem indicates that the tube is slipping inside of the tire or the tire is slipping on the rim. See your Zuumav dealer for assistance.

TIRE & TUBE REPLACEMENT

If a tube has been punctured or damaged, it should be replaced immediately. You may repair the tube using a tube patch kit. However, a repaired tube may not have the same reliability as a new one and could fail while riding. For more information on a temporary repair, see the section titled [Resolving the Unexpected](#).

Always use replacement tubes that are the same size as the original. We recommend that you have tubes changed at your local Zuumav dealer or your local motorcycle shop. Replacing a tube requires removal and installation of the wheel. The tires that came on your motorcycle were designed to provide a good combination of handling, braking, durability and comfort across a broad range of riding conditions.

- Use a replacement tire equivalent in size and type to the original tire.
- Replace the tube anytime you replace a tire. Old tubes are usually stretched and, if installed in a new tire, could fail.
- Have the wheel balanced after a new tire has been installed.
- We recommend that tires be replaced by your Zuumav dealer or a local motorcycle shop.

TIRE PRESSURE

Front Tire	18 - 20 Psi (124 - 138 kPa)
Rear Tire	18 - 20 Psi (124 - 138 kPa)
Type	Bias Ply, Tube Type

WARNING

INSTALLING IMPROPER TIRES ON YOUR MOTORCYCLE CAN AFFECT HANDLING AND STABILITY, WHICH, IF SEVERE, CAN CAUSE A CRASH IN WHICH YOU CAN BE SERIOUSLY HURT OR KILLED. ALWAYS USE THE SIZE AND TYPE OF TIRES RECOMMENDED IN THIS OWNER'S MANUAL.

BASIC MAINTENANCE PROCEDURES

Maintenance of spoke tension and wheel trueness (roundness) is critical to safe motorcycle operation. During the first 100 miles of riding, spokes will loosen faster due to the initial seating of the parts. Excessively loose spokes will cause the motorcycle to become unstable at high speed and could cause you to lose control. Loose spokes can also cause rim and spoke damage (not covered in the warranty). It is not necessary to remove the wheels for regular maintenance. However, information on wheel removal is available from Zuumav.



WHEEL INSPECTION FRONT & REAR

1. Inspect the wheel rims **A** and spokes **B** for damage or looseness. Feel the spokes with your fingers to make sure none are loose.
2. Tighten any loose spokes with a small adjustable wrench or spoke wrench from the spoke nut **C**.
3. Elevate each wheel off the ground, one at a time, and spin the wheel slowly. Look for a wobble in the wheel. If a wobble is evident, the wheel is not "true". See your local Zuumav dealer or local motorcycle shop for inspection of the wheels.

TIRE AIR PRESSURE

Properly inflated tires will provide you with the best combination of handling, tread life, and riding comfort. Underinflated tires will wear unevenly and adversely affect handling. Underinflated tires are also more likely to fail from being overheated and can cause wheel damage on rocky terrain. Overinflated tires will cause the motorcycle to ride harshly, are prone to failure from surface hazards and wear unevenly.

Make sure the valve stem caps are secure, if needed, install a new cap. Always check air pressure when your tires are cold. If you check the air pressure when the tires are warm, you will get higher readings. If you let air out of warm tires to match the recommended cold tire pressure, the tires will be under inflated. The correct cold tire pressures are listed below. If you replace the tire, follow the tire Pressure marked on the sidewall of the tire.

TIRE PRESSURE

Front Tire	18 - 20 Psi (124 - 138 kPa)
Rear Tire	18 - 20 Psi (124 - 138 kPa)

WARNING

USING TIRES THAT ARE EXCESSIVELY WORN OR IMPROPERLY INFLATED CAN CAUSE A CRASH IN WHICH YOU CAN BE SERIOUSLY INJURED OR KILLED. FOLLOW ALL INSTRUCTIONS IN THIS OWNER'S MANUAL REGARDING TIRE INFLATION AND MAINTENANCE.

BRAKING TECHNIQUE

This section will cover basic braking technique for your motorcycle. To slow or stop the motorcycle, squeeze and hold the clutch lever and apply the front brake lever and rear brake pedal firmly and smoothly. If your speed is reduced a significant amount, you may need to downshift to a lower gear. Gradually increase your braking pressure as you feel it is needed. When you come to a stop, put your left foot down first, then the right foot. Do this so that your brake pedal foot remains on the brake pedal until you come to a complete stop. To prevent the engine from stalling, always pull and hold the clutch lever when slowing to a complete stop unless you are in neutral.

For maximum braking, close the throttle and firmly apply both the front and rear brake. On a motorcycle, the front brake accounts for 70% of the total stopping power of the motorcycle. The rear brake only accounts for 30%. This is because of the weight transfer that occurs when you apply the brakes. When you must stop quickly, you must use the front brake together with the rear brake. Remember that you can apply more brake to the front wheel than you can to the rear wheel before it will lock up and cause a skid. Finding the proper balance between the amount of front and rear brake pressure you use will come with experience. Attempting an abrupt stop with only the rear brake will likely cause a skid.

Applying the brakes too hard or too fast can cause the wheels to lock and cause a skid, reducing your control of the motorcycle. If this happens, release the brake controls and steer straight ahead until you regain control of the motorcycle. Once you have control, reapply the brakes with less force.

Generally, reduce your speed and complete your braking before you begin a turn. Avoid braking or closing the throttle quickly while turning. Either of these actions may cause one or both of the wheels to slip. Any wheel slip will reduce your control over the motorcycle and could cause a crash. When riding in wet or rainy conditions, or on loose surfaces such as mud or sand, your ability to maneuver and stop the motorcycle will be reduced. All of your actions should be done in a smooth and steady manner under these conditions. Rapid acceleration, braking, or turning can cause you to lose control of the motorcycle. For your safety, exercise extreme caution when riding under wet, rainy, and/or muddy conditions.

When descending a long, steep grade, use engine compression braking by downshifting with intermittent use of both brakes.

PARKING & POST RIDE INSPECTION

Lower the side stand, to support your motorcycle. Press and hold the red stop switch on the left side of the handle bar until your engine stops. If you are through riding for the day, turn the fuel valve to the "OFF" position. Always park the motorcycle on a flat level surface. If you will be storing the motorcycle for a long period of time, turn the fuel valve to the "OFF" position while the engine is still running. Open and close the throttle repeatedly until the engine stops running on its own. Do this to use up any fuel that still remains in the carburetor. This will help you avoid carburetor problems that can occur when your motorcycle is stored for long periods of time with gasoline left in the carburetor.

MAINTAINING YOUR ZUUMAV DIRTBIKE

Keeping your motorcycle in perfect operating condition is absolutely essential to your safety. It is also the best way to protect your investment, get maximum performance, avoid breakdowns, and have more fun. To help keep your motorcycle well maintained, this section includes a maintenance schedule for required servicing and step-by-step instructions on how to perform specific maintenance tasks. In this section you will also find important safety precautions, information on oils, and tips for keeping your Zuumav looking good.

Careful pre-ride inspections and good maintenance are invaluable because your motorcycle is designed to be ridden over rough, off-road terrain. To help you properly care for your motorcycle, this section provides you with a maintenance schedule. The service intervals in this section are based on average riding conditions. More frequent service is needed if you subject your motorcycle to severe use, such as competition, or ride in unusually wet and dusty areas. Frequent checks of the air cleaner are very important to help you avoid engine damage.

Remember, proper maintenance is the responsibility of the owner. Be sure to inspect your motorcycle before each ride and follow the maintenance schedule in this section.

WARNING

Improperly maintaining this motorcycle or failing to correct a problem before you ride can cause a crash in which you can be seriously injured or killed. Always follow the inspection and maintenance recommendations and schedules in this manual.

NOTICE TO PARENTS

As a parent, it is up to you to make sure the motorcycle is properly maintained and kept in safe operating condition. For youngsters, learning how to take care of a motorcycle and perform basic maintenance can be an important part of their riding experience. However, if you allow a youngster to perform or assist in any maintenance task(s), such as filling the fuel tank with gasoline, you need to provide close supervision and make sure the task is performed safely.

WARNING

Failure to properly follow maintenance instructions and precautions can cause you to be seriously hurt or killed. Always follow the procedures and precautions in this manual.

IMPORTANT SAFETY PRECAUTIONS

Make sure the engine is off before you begin any maintenance or repairs. This will help eliminate the following hazards:

1. **Carbon Monoxide Poisoning from Engine Exhaust** – Be sure you have adequate ventilation whenever you operate the engine.
2. **Burns from Hot Motorcycle Parts** – Let the engine and exhaust system cool off before you touch them.
3. **Injury from Moving Parts** – Do not run the engine unless instructed to do so.

Read all instructions before you begin a procedure. Make sure you have all of the tools and skills required. To help prevent the motorcycle from falling over, park it on a firm, level surface, using the side stand or a maintenance stand to provide support. To reduce the chance of a fire or explosion, be careful when working around gasoline. Use only a non-flammable (high flash point) solvent such as kerosene to clean parts. Keep cigarettes, sparks, and flames away from all fuel related parts.



BASIC MAINTENANCE PROCEDURES

SUSPENSION Cont.

7. Next, you will find the rebound adjuster at the bottom of the shock absorber, under the swing-arm. This works much the same as the rebound screw on the front forks. It controls how quickly or slowly the shock returns to its extended position after being compressed.
8. Try turning it clockwise to allow the rear wheel to stay in contact with the ground over larger rolling terrain.
9. If you turn the screw counter-clockwise, this will give you a better ride over rough bumps that are close together by allowing the shock to rebound faster and "hug" the flow of the terrain.

SHOCK ABSORBER DAMPING

(if applicable)

1. The rebound damping adjuster  is located at the lower end of the shock absorber.
2. It has 12-14 adjustment positions. Turning the adjuster screw one full turn advances the adjuster by 4 positions (clicks).
3. Rebound damping can be increased by turning the adjuster clockwise  or counter-clockwise .
4. To adjust to the standard position, turn the adjuster clockwise until it will not longer turn (DO NOT FORCE). This is the fully hard setting.
5. Turn the adjuster counter-clockwise 9-12 clicks.



NOTICE

DO NOT TRY TO REPAIR THE SHOCK. IF REPAIR IS NECESSARY, TAKE THE MOTORCYCLE TO A ZUUMAV DEALER.

BASIC MAINTENANCE PROCEDURES

SUSPENSION Cont.

SPRING PRE-LOAD Cont.

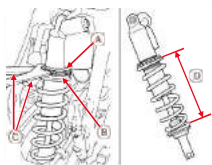

(If applicable)

Increase Spring Pre-Load

1. Loosen the lock nut on the spring with the spanners **C** and turn the adjuster nut clockwise to shorten the spring length **D**.
2. One complete turn of the adjuster nut changes the spring length by approximately 1.5 - 2 mm.
3. After the adjustment has been done, hold the adjuster nut and tighten the spring lock nut.
4. Make sure the lock nut is tight before you assemble the remaining parts.

Decrease Spring Pre-Load

1. Loosen the lock nut on the spring with the spanners **C** and turn the adjuster nut counter-clockwise to increase the length of the spring **D**.
2. One complete turn of the adjuster nut changes the spring length by approximately 1.5 - 2 mm.
3. After the adjustment has been done, hold the adjuster nut and tighten the spring lock nut.
4. Make sure the lock nut is tight before you assemble the remaining parts.

SHOCK ABSORBER DAMPING

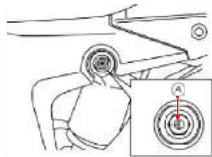

(If Applicable)

Compression Damping

A. The high-speed compression damping **A** is effective when damping adjustment is desired for high speed operation.

B. The low-speed compression damping **B** is effective when damping adjustment is desired for low speed operation.

1. Both the high and low speed compression damping can be increased or decreased by turning the enter screw adjuster clockwise or counter-clockwise.
2. You can adjust the adjuster by turning it 1/12th turn increments (clicks).

MAINTENANCE SCHEDULE

To keep your motorcycle safe and reliable when you ride, regular inspections and service is required. Below you will find a maintenance schedule that describes when components need to be inspected or serviced. The maintenance schedule lists item that can be performed with basic mechanical skills and hand tools. In addition, the maintenance schedule will list items that involve more extensive procedures and could require special training, tools and/or equipment.

Because this motorcycle does not have an odometer, service intervals in the maintenance schedule are expressed in terms of riding days. To avoid missing required maintenance, we suggest that you develop a good way to record the amount of time you spend riding your motorcycle. If you do not feel capable of performing any of the procedures described in this manual or if you need assistance, please contact your nearest Zuumav dealer. If you decide to do your own maintenance, use only replacement parts that you have purchased from a Zuumav dealer or parts purchased directly from Zuumav. This will ensure the best quality and reliability for your motorcycle.

Always perform the pre-ride inspection described on page 16 at each scheduled maintenance interval.

Each item on the maintenance schedule requires some mechanical knowledge. You will find that some items in the table (marked * and **) may require a higher level of mechanical skill and special tools. If you do not feel capable of performing any procedure, please consult your nearest Zuumav dealer.

* Indicates items that require a moderate to high level of mechanical skill. We recommend service by a Zuumav dealer if the owner is not mechanically qualified.

** Indicates items and procedures that require special tools.

Note: Service your motorcycle more frequently when you ride in wet or dusty conditions.

Maintenance Procedures: I = Inspect (clean, adjust or replace if needed), C = Clean, A = Adjust, L = Lubricate, R = Replace

Items	Frequency	Month/Distance					
		1month/200mi	3months/1000mi	12months/20000mi	24months/40000mi	36months/60000mi	48months/80000mi
* Fuel Line			I	R	I	R	I
* Fuel Filter		I	R	I	R	I	I
* Throttle Operator			I	I	I	I	I
Oil Filter		C	C	C	C	C	C
Spark Plug		I	I	I	I	I	I
Engine Oil	R	R					
* Engine Oil Speed		I	I	I	I	I	I
Drive Chain				Inspect & Lubricate every three months or 300 miles			
Drive Chain Sprocket		I	I	I	I	I	I
Rear pad Wear		I	I	I	I	I	I
Brake System	I	I	I	I	I	I	I
* Brake System	I	I	I	I	I	I	I
* Side Stand		I	I	I	I	I	I
* Suspension		I	I	I	I	I	I
Spare Armrest		C	C	C	C	C	C
Nuts, Bolts, Fasteners	I	I	I	I	I	I	I
* Oilhead & Tires	I	I	I	I	I	I	I
* Steering Head Bearings	I	I	I	I	I	I	I
Oil Filter	R	R			R	R	R

Maintenance Procedures: I=Inspect (Clean, Adjust or Replace if needed), C=Clean, A=Adjust, L=Lubricate, R=Replace.

MAINTENANCE SCHEDULE

Maintenance Required Intervals

	Once after 1 operating hour	Every 10 hours	Every 20 hours	Every 30 hours	Every 40 hours	Every 50 hours	Every 100 hours	Annually
Check front brake pads for wear (1)								*
Check rear brake pads for wear (1)								*
Check the battery status and charge (2)								*
Check front and rear brake discs (1)								*
Check the brake hose for any damage or leaks								*
Check front and rear brake fluid levels (1)								*
Check free play of the rear brake pedal (1)								*
Check frame and swing-arm for cracks or damage (2)								*
Check swing-arm bearings for play (2)								*
Check the rear shock absorber top bolt (2)								*
Check shock absorber linkage connection (2)								*
Check the rear linkage for excessive play (2)								*
Check front and rear tire conditions (1)								*
Check tire air pressure (1)								*
Check front and rear wheel bearings for play (2)								*
Check the front and rear wheel hubs for cracks or damage (2)								*
Check spoke tension (2)								*
Check the drive chain, Engine sprocket, Drive sprocket (1)								*
Check the chain guide and swing-arm chain slider (1)								*
Check the chain free-play (2)								*
Lube all moving parts (levers, chain etc.) & check for smoothness (2)								*
Check the free-play of the hand brake and clutch levers (2)								*
Check the steering bearing play (2)								*
Check valve clearance (2)								*
Check clutch friction plates (2)								*
Change water pump cover gasket, o-rings, shaft seal and impeller (2)								*
Change engine oil, air filter and clean both oil screens (2)								*
Check all hoses (cooling, breather, drainage, fuel etc.) (2)								*
Check the antifreeze coolant levels (1)								*
Check throttle and clutch cables for damage and routing without sharp bends (2)								*
Clean air filter and filter box (2)								*
Check nuts and bolts for tightness (2)								*
Change the fuel filter (1)								*
Check Idle speed (2)								*
Make any and all service entries in the warranty and service booklet (2)								*
Change front and rear brake fluid (2)								*
Grease steering head bearings (2)								*
Front fork service (2)								*

BASIC MAINTENANCE PROCEDURES

The rear suspension of your motorcycle has 2 different adjustment points. It can be adjusted for the rider's weight and riding conditions by changing the spring pre-load, rebound and compression damping points. It comes from the factory set to the softest setting. If you wish to make the rear suspension harder, follow the procedures below. Adjusting the rear shock is not hard, but like the front forks, changes should be made one at a time to gain an accurate understanding of how they affect the bike.

Once you are familiar with the settings on your suspension, you can quickly and easily adjust them to suit different terrain. For example, you know the setting position for when you ride in the sand dunes. But when you are riding on your local track you know to tune them to a different setting. The rear shock absorber has a damper unit that contains high pressure nitrogen gas. Do not attempt to disassemble, service or dispose of it. Puncture or exposure to flame may also result in an explosion, causing serious injury or even death. Service or disposal should only be done by your dealer or a qualified mechanic that is equipped with the proper tools and safety equipment. If your H7L motorcycle is new, put about 2 hours of part throttle break in time on it to ensure that the shock absorber has worked in.

SPRING PRE-LOAD

(If applicable)

The spring pre-load should be adjusted when the engine is cold because it will be necessary to remove the muffler(s). A second spanner will be needed for turning the shock spring lock nut and adjusting the nut in order to adjust the spring pre-load.

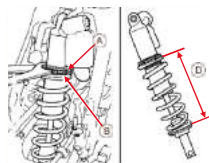

1. Recommended to place your H7L on a stand or equivalent support with the rear wheel off the ground.
2. Remove the mufflers.
3. Loosen the clamp on the air filter duct connecting the carburetor.
4. Remove the battery terminal connectors.
5. Remove the sub-frame with the air filter housing on one piece.
6. Check that the spring pre-load is adjusted to the standard length.
7. Adjust as necessary by loosening the shock spring lock nut (A) and turning the adjusting nut (B).
8. One complete turn of the adjuster nut changes the spring length by approximately 1.5 - 2 mm.
9. After the adjustment has been done, hold the adjuster nut and tighten the spring lock nut.
10. Make sure the lock nut is tight before you assemble the remaining parts.

BASIC MAINTENANCE PROCEDURES

SUSPENSION Cont.

SUSPENSION AIR PRESSURE (Front)





(if applicable)

Air is usually an unstable gas which does build up pressure as its worked (usually in the forks). Air pressure acts like a progressive spring which effects the travel range of the forks. Meaning, the fork action on your motorcycle will get stiffer during a race or long hours on the test track. You need to relieve the accumulated pressure in the forks by using the pressure relief screws in the following order:

1. Place the motorcycle on a motorcycle stand.
2. Make sure the front wheel is off the ground, it must be fully extended.
DO NOT remove the relief screw with the front wheel on the ground.
3. Slowly remove the relief screw  by turning it counter-clockwise.
4. Do this to both left and right fork.
5. Remove the relief screw and check the O-rings are in good condition. If they are not, they need to be replaced before your next ride.
6. Once the pressure has been released, install and tighten the relief screws by turning them clockwise. Do not over tighten them, just enough to be snug. Overtightening will damage the O-rings.

MAINTENANCE SCHEDULE

Rear shock service 							*		
Change fuel filter 			*				*		*
Minor engine service: (Change spark plug and boot. Check piston for damage and wear (replace if necessary), check and measure piston cylinder, check cylinder head, check camshaft, check timing, check intake flange (replace if necessary), check valve seals and springs (replace if necessary). 									*

(O) One-time Interval

(*) Periodic Intervals

 Reference Owner Manual

 Maintenance Inspection, Scheduled Service

BASIC MAINTENANCE PROCEDURES

FUEL (GASOLINE)

Fuel Recommendation – Any unleaded gasoline with an octane rating of 90 or higher.

The engine in your motorcycle has been designed to run on any gasoline with a pump octane rating of 86 or higher. Most service stations will display the octane rating above each pump. Although it is not required, Zuumav recommends use of gasoline with a 90 octane, rating or higher to ensure maximum performance and reliability.

Use of a lower octane gasoline can cause pre-detonation in the engine. When this occurs, you will hear a persistent “pinging” or “spark knock” which, if severe, can cause engine damage. It is however no cause for concern if you hear light pinging while the engine is under hard acceleration, such as climbing up a hill. If pinging occurs under normal load and a steady engine speed, switch brands of gasoline and be sure you are using the proper octane rating. Use of unleaded fuel is recommended because it produces fewer engine deposits and extends the life of the engine and exhaust components.

Never use stale or contaminated gasoline. Never use gasoline that has been mixed with oil. Avoid getting dust, dirt and water into the fuel tank.

INSPECTION & REFUELING PROCEDURE

1. Before refueling your motorcycle, check the fuel hoses ② for leaks, damage, cracks, or deterioration.
2. Replace the fuel hose if you feel it is necessary.
3. Inspect the fuel filter replace if necessary.
4. Twist the fuel tank cap ① counter-clockwise and remove the cap from the tank.
5. Using a funnel, add fuel to the tank until the level reaches about 2 inches from the top of the tank.
6. Twist the fuel cap clockwise until it is securely tight.
7. Be sure that you have the breather tube ② connected to the gas tank cap.

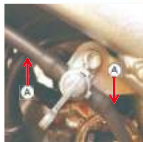

WARNING

Gasoline is highly flammable and explosive. You can be burned or seriously injured when handling gasoline. Always stop the engine. Only handle gasoline outdoors. Clean all spills immediately.

BASIC MAINTENANCE PROCEDURES

SUSPENSION DAMPING (Front)



Compression Adjustment (if applicable)

This adjustment effects how quickly the front forks compress. The compression adjuster has 18 click positions. Turning the compression adjuster screw one click changes how the fork compression responds. To adjust the forks to the standard position, please follow the instructions as follows:

1. Turn the adjuster screw ① fully clockwise until it will not turn any longer (lightly seated). This is the full hard position.
2. Turn the adjuster counter-clockwise 6-7 clicks. This is the standard position.
3. Make sure both fork adjustments are set to the same position.

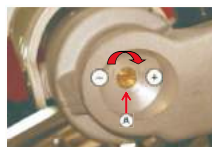

Rebound Adjustment (if applicable)

This adjustment effects how quickly the front forks rebound back from a compressed position. The rebound adjuster has 16-18 clicks. Turning the rebound adjuster screw one click changes how quickly the forks extend. To adjust the forks to the standard position, please follow the instructions as follows:

1. Turn the adjuster screw ① fully clockwise until it will not turn any longer (lightly seated). This is the full hard position.
2. Turn the adjuster counter-clockwise 10-11 clicks. This is the standard position.
3. Make sure both fork adjustments are set to the same position.

NOTICE

DO NOT TRY TO REPAIR THE FORKS. IF REPAIR IS NECESSARY, TAKE THE MOTORCYCLE TO A ZUUMAV DEALER.

BASIC MAINTENANCE PROCEDURES

Loose, worn or damaged suspension components may affect the stability and handling of your motorcycle. If any of the suspension components seem to be worn or damaged, see your Zumav dealer for service and/or inspection. Your Zumav dealer is the most qualified to determine, whether or not replacement parts or service is required. Your motorcycle is new. Break it in for about 2 hours with the original settings before attempting adjustments.

SUSPENSION INSPECTION (Front)

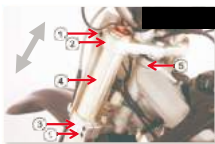

1. Check the fork ① operation by pulling in the front brake lever and holding it to lock the front wheel.
2. Make sure the plastic fork protectors and dust seals are clean and not packed with dirt or mud.
3. Next, pump down on the handle bars several times. The suspension should feel clean and smooth.
4. Check the lower end of the forks (near the wheel) for oil leaks. Damaged or leaking fork seals should be replaced before your next ride.
5. Inspect the upper ② and lower ③ triple clamps for tightness.
6. Be sure all the triple clamp bolts ④ are tight.
7. Examine the metal for any cracks, wear or other damage.
8. Be sure there is no free-play in the steering head ⑤.

SUSPENSION INSPECTION (Rear)

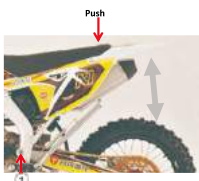

1. Move the motorcycle by bouncing it up and down to check for smooth suspension action.
2. Check for a broken or damaged spring.
3. Check the shock absorber for a bent center shaft or any oil leaks.
4. Check the nuts and bolts of the shock for tightness.
5. Check the spring adjuster(s) ring for tightness.
6. Check the swing arm bolt for tightness.
7. Check the bottom linkage nuts and bolts for tightness.
8. Push the rear wheel sideways to check for any worn or loose swingarm bearings ①. If there is, have the bearings replaced by your Zumav dealer.

NOTICE

DO NOT TRY TO REPAIR THE SHOCK. IF REPAIR IS NECESSARY, TAKE THE MOTORCYCLE TO A ZUMAV DEALER.

BASIC MAINTENANCE PROCEDURES

ENGINE OIL

Using proper oil, and regularly checking, adding and changing oil will help extend the service life of your engine. Even the best oil wears out and becomes thinner. Changing oil helps get rid of dirt and deposits in the engine. Operating the engine with old or dirty oil may and may damage your engine. Running the engine with not enough oil can cause serious damage to your engine.

Engine Oil Recommended – SAE 10w40 / 10w-50 Motor Oil. *

Indicates oil for regular air temperatures. Please see the oil/air temperature chart to help you choose the best oil for your climate.

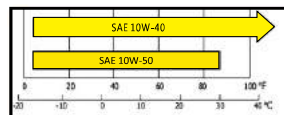

CAUTION

Your motorcycle does not need oil additives. ONLY use the recommended oil. DO NOT use oil with graphite or molybdenum additives, they may adversely affect the clutch operation. DO NOT use motor oils that display the API circular logo that is labeled "energy conserving", they may affect the lubrication and clutch performance.

CHECKING & ADDING OIL

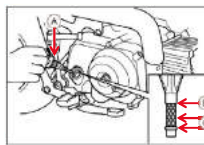

Fig. 1

1. Stand the motorcycle upright on a horizontal surface. Remove the oil filler cap ①.
 - A. Engine is cold. Check the engine oil level with the oil dipstick.
 1. Engine oil reaches the top notch of the level viewer. ③ **No need to add engine oil.**
 2. Engine oil is in the middle or below of the level viewer. **Need to add engine oil until it reaches the top notch of the level viewer.**
 - B. Engine is at operating temperature. Check the engine oil level with the oil dipstick.
 1. Engine oil reaches the top notch of the level viewer. **No need to add engine oil.**
 2. Engine oil is in the middle or below ④ of the level viewer. **Need to add engine oil until it reaches the top notch of the level viewer.**

NOTICE

If the oil filter and cap are not installed correctly, it will cause serious engine damage.

NOTICE

Improper disposal of drained fluids is harmful to the environment.

NOTICE

Dispose of drained oil in an appropriate manner. Most parts stores or auto shops do take used oil.

BASIC MAINTENANCE PROCEDURES

CHANGING OIL

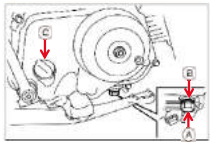

1. Park the motorcycle on a level surface.
2. Place a suitable oil container under the engine.
3. If the engine is cold, start it and let it idle for 3-5 minutes.
4. Turn the engine off.
5. Wait 2-3 minutes for the oil to settle.
6. Remove the oil fill cap (C) and the seal ring (B).
7. Remove the oil drain bolt (A) and the seal ring (B).
8. Let the oil drain out from the engine.
9. After most of the oil has drained, slowly tilt the motorcycle from side to side to drain the remaining oil in the crankcase.
10. A suitable container must be used to pour the drained oil and to be disposed of in an approved manner.
11. Remove the old sealing ring (B) and install a new sealing ring on the drain bolt.
12. Install the drain bolt and tighten to specified torque of: 18lbs.ft (24N.m)
13. Pour recommended oil in the crankcase through the oil fill cap: Approx. 0.6l
14. Install the oil fill cap/dipstick and tighten.
15. Start the engine and let it idle for 3-5 minutes.
16. Stop the engine.
17. Wait 2-3 minutes for the oil to settle.
18. Remove the oil dipstick, wipe off the oil, insert the dipstick back but do not tighten it.
19. Remove the dipstick and check the level.
20. If needed, add more oil until the level is at the top mark on the dipstick. **DO NOT OVERFILL.**

BASIC MAINTENANCE PROCEDURES

Hydraulic disc brake systems use a brake caliper to squeeze the rotors (brake disc) which causes the motorcycle to stop. Inside the brake caliper are brake pads. The brake pads are the part of the brake system that makes contact, with the brake rotor. The pads must be checked in accordance with the maintenance schedule for the brake system as described on page 24. Follow the procedure below to check the brake pad wear. Brake pad wear depends on the severity of use and track conditions. (Usually, the pads will wear out faster with wet and dirty track conditions.)

ADDING BRAKE FLUID (Front)

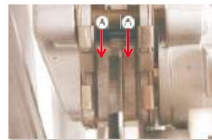

1. Inspect the brake pads (A) at each maintenance interval through the wheel to determine the brake pad wear. (More frequently if you do a lot of riding).
2. If either of the pads are worn down to a thickness of 1 mm, then both pads MUST be replaced.
3. If one side has worn down more extensive than the other, consult your ZUMAV dealer for a possible bad brake caliper.
4. If you are unsure how to replace the brake pads, please contact your nearest ZUMAV dealer for assistance, or schedule your motorcycle for servicing.

BLEEDING THE BRAKE SYSTEM

Because the brake system utilizes fluid, any air bubbles inside the brake system will cause you to lose braking efficiency. Air generally enters the brake system when the motorcycle sits unused for long periods of time. Air will also enter the system if you have a leaking brake hose, brake caliper or master cylinder. A brake system with air will cause the brake lever and pedal to feel soft and spongy. Use the procedure below to bleed air from both the front and rear brake system.

ADDING BRAKE FLUID (Front)



NOTICE
USE ONLY DOT 4 BRAKE FLUID.

1. Clean all dust and dirt from the bleeder screw and remove the rubber screw cap.
2. Slowly pump the brake lever or pedal slowly and firmly 4 – 6 times and then hold it (keep it in the pressed position).
3. Using an 8mm bleeder wrench, loosen (A) the bleeder screw (B) located on the brake caliper. You will see brake fluid, and possibly some air will exit out of the bleeder screw.
4. Once the fluid has stopped, tighten (C) the bleeder screw and then slowly release the lever or pedal.
5. Repeat steps 2 – 4 until all air bubbles have stopped flowing from the bleeder screw and only fluid is coming out. The lever/pedal should feel hard and firm when you are complete.
6. If the fluid level in the master cylinder is going down, please remember to replenish the fluid until the air bleeding is done.

BASIC MAINTENANCE PROCEDURES

Hydraulic brakes require brake fluid for its operation. Both front and rear brakes have a brake fluid reservoir built into the master cylinders. Follow the procedures below to check and fill the cylinders with the specified brake fluid.

BRAKING SYSTEM Cont.

RECOMMENDED BRAKE FLUID ONLY – DOT 4

NOTICE
USE ONLY DOT 4 BRAKE FLUID.

ADDING BRAKE FLUID (Front)

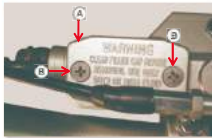

1. Clean all dirt and dust from the master cylinder cap before opening.
2. Remove the cap screws **B** with a phillips head screwdriver.
3. Remove the cap. Be careful not to damage the diaphragm gasket that is seated under the cap.
4. Add the required amount in to the cylinder (DO NOT OVERFILL) Always use new fluid from a sealed container.
5. Replace the diaphragm and cap and tighten the screws securely.
6. Slowly squeeze the brake lever to be sure the brakes are working properly.
7. Check the brake hose and brake caliper for leaks.

ADDING BRAKE FLUID (Front)

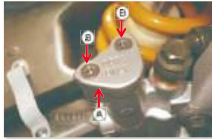

8. Clean all dirt and dust from the master cylinder cap before opening.
9. Remove the cap screws **B** with a phillips head screwdriver.
10. Remove the cap. Be careful not to damage the diaphragm gasket that is seated under the cap.
11. Add the required amount in to the cylinder (DO NOT OVERFILL) Always use new fluid from a sealed container.
12. Replace the diaphragm and cap and tighten the screws securely.
13. Slowly squeeze the brake lever to be sure the brakes are working properly.
14. Check the brake hose and brake caliper for leaks.

If you are unsure how to re-assemble a part, please contact your ZUUMAV dealer for servicing information and/or servicing.

NOTICE
USE ONLY DOT 4 BRAKE FLUID.

NOTICE
Be very careful not to spill brake fluid on painted surfaces or it will damage the paint. It will also be harmful to some rubber parts. Be careful when you remove the master cylinder cap, make sure the motorcycle is in an upright position.

BASIC MAINTENANCE PROCEDURES

Proper air filter maintenance is extremely important for off-road vehicles. A dirty, water-soaked, worn-out air filter will allow dirt, dust, mud or other impurities to pass into the engine. If you are riding in wet and/or muddy areas, you should service the air filter more often. Always replace the air filter with a genuine Zuumav filter specifically designed for your model or a filter of equal quality. Failure to maintain the filter can/may cause engine wear or damage, expensive repairs, low engine power, low fuel mileage, carbon build up on valves and foul the spark plug.

CHANGING / CLEANING AIR FILTER

1. Loosen the air filter clamp by turning it counter-clockwise.
2. Remove the air filter, careful not to tear the filter as you are removing it from its location.
3. Remove the top foam cover.
4. Use an industrial filter solvent manufactured specifically for foam filters.
5. Once you have cleaned the filter thoroughly, rinse with warm water, let air dry. DO NOT put it directly under the sun.
6. After the 2 parts of the filter are dry, place them in a plastic bag and add 0.80 oz (24 mL) of clean new foam air filter oil on the filter.
7. Close the plastic bag and spread the oil evenly around the filter.
8. Drain off any excess oil in the bag before assembly on the 2 foam filter pieces.
9. Install the filter back on to the carburetor and tighten the clamp by turn it clockwise.
10. Be sure the clamp is secure. If the filter should come loose, dust and dirt will go inside the carburetor and engine and cause damage.

NOTICE
Improper installation of the air cleaner assembly may will allow dirt and dust to get inside the engine and cause rapid wear of the piston rings and cylinder

NOTICE
Improper or lack of proper air filter maintenance can/will cause poor performance.

BASIC MAINTENANCE PROCEDURES

THROTTLE ADJUSTMENT

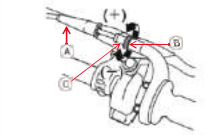

- A.** Throttle free-play should be 3 – 5 mm (0.10-0.20 in.)
B. If your throttle has more or less free-play than specified above, adjustments need to be made. Follow the steps below.
1. Pull back the rubber dust cover **A**.
 2. Loosen the lock nut **B**.
 3. Turn the adjuster **C** in the **⊖** direction will decrease the free-play. Turn the adjuster in the **⊕** direction will increase free-play.
 4. Operate the throttle to ensure that it is functioning smoothly, and when released, it returns completely very quickly from full open throttle to fully closed in all steering positions.
 5. Inspect the condition of the throttle cable from the throttle down to the carburetor. If the cable is nicked or chafed, it must be replaced.
 6. Lubricate the cable with a commercially available cable lubricant to prevent premature rust and/or corrosion.
 7. Check the cable for tension or stress in all steering positions.

THROTTLE ADJUSTMENT

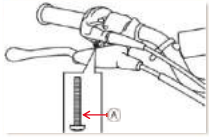

8. You can reduce the throttle open position by means of the throttle limiter screw **A**.
9. To activate the throttle limiter, turn the screw clockwise, this will reduce the amount the throttle is able to turn to the open position.
10. To deactivate the throttle limiter, turn the screw counter-clockwise, this will increase the amount the throttle is able to turn in the wide-open position.
11. Use only the screw that is installed on the limiter. Do Not Use any other screws.
12. Do not remove the screw completely out of the limiter as this will cause debris to enter the housing and cause the throttle to bind.

BASIC MAINTENANCE PROCEDURES

Both the front and rear brakes are the hydraulic oil disc type. As the brake pads wear out, the brake fluid level will drop. A leak in the system will also cause the level to drop. Frequently inspect the system to ensure there are no fluid leaks. Periodically inspect the brake fluid level and the brake pads for wear. If the braking response of the front brake lever or rear pedal feels unusual, check the brake pads. If the brake pads are not worn beyond the recommended limits, there is probably air in the brake system. Refer to your local ZUUMAV dealer to have the air bled from the system.

BRAKING SYSTEM (Front Brake Lever)

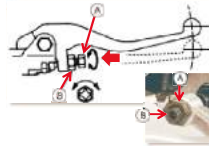

(if applicable)

1. Loosen the lock nut **A**.
2. To position the brake lever away from the grip, turn the adjuster **B** clockwise.
3. To position the brake lever closer to the grip, turn the adjuster counter-clockwise.
4. Once you determine the lever is in a good position, while holding the adjuster, tighten the lock nut.
5. Apply a little bit of silicone grease or marine grease to the contacting areas of the adjuster.

BRAKING SYSTEM (Rear Brake Pedal)



1. Loosen the lock nut **A** and turn the push rod **B** in the **⊕** direction to raise the rear brake pedal or in the **⊖** direction to lower it.
2. Tighten the adjuster lock nut at the desired pedal height.
3. The brake pedal height should be approximately level with the foot rest.

BRAKING SYSTEM (Front Fluid Level Check)



1. With the motorcycle in the upright position, check the brake fluid level. It should be above the indicator mark **A** on the master cylinder. If the level is below the mark, check the brake pads for wear. Worn out pads should be replaced. If the brake pads are not worn out, check your brake system for leaks.

BRAKING SYSTEM (Rear Fluid Level Check)



1. With the motorcycle in the upright position, check the brake fluid level. It should be above the indicator mark **A** on the master cylinder. If the level is below the mark, check the brake pads for wear. Worn out pads should be replaced. If the brake pads are not worn out, check your brake system for leaks.

BASIC MAINTENANCE PROCEDURES

SPARK PLUG Cont.



NOTICE

Using a spark plug with an improper heat range or incorrect reach, can cause engine damage. Using a non-resistor spark plug may cause ignition problems.



NOTICE

An improperly tightened spark plug can damage the engine. If a plug is too loose, a piston may be damaged. If a plug is too tight, the threads may be damaged.

BASIC MAINTENANCE PROCEDURES

ENGINE IDLE SPEED ADJUSTMENT



The idle setting of the carburetor has a big influence on the vehicle's starting behavior, on stable idling and on the vehicle's response when the throttle is opened. An engine with a correctly set idle speed is easier to start than an engine with the idle speed set incorrectly. The idle speed is adjusted with the idle speed adjusting screw.

1. If the engine is cold, start it up and warm it up for 3-4 minutes. Then shut it off.
2. Connect a tachometer to the engine.
3. Shift the transmission into neutral. Start the engine.
4. Remember to keep the motorcycle in an upright position.
5. Adjust the idle speed with the idle adjusting screw or knob **A**.
6. Idle Speed: **1,500 – 1,800 ± 100 RPM**
7. The idle screw is sometimes located in different positions on most carburetors. Some examples are given to the left.
8. **NEVER ADJUST THE AIR/FUEL MIXTURE SCREW IT HAS BEEN SET AT THE FACTORY AND SHOULD ONLY BE ADJUSTED BY AN AUTHORIZED ZUUMAV DEALER.**

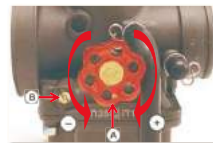

CAUTION

Carburetor and engine areas are very hot, especially after a long ride. Wear hand protection before attempting to make adjustments to the carburetor.

BASIC MAINTENANCE PROCEDURES

In order, to ensure the best performance and durability from the clutch, always be sure you have proper clutch free-play. Free-play is needed to ensure that the clutch has room for wear. A clutch with no free-play will begin to slip as the discs wear down. Failure to fix a slipping clutch can cause clutch damage. To check the free-play, simply pull on the clutch lever. The lever should move very easily within the free-play range before you feel the clutch begin to engage. If too much or too little free-play exists, adjustments are needed.

CLUTCH LEVER & CABLE ADJUSTMENT

A. Clutch Lever Adjustment (if applicable)

The distance between the grip and the tip of the clutch lever can be adjusted to suite the size of your hand.

1. Loosen the lock nut **(A)**.
2. To make the position of the clutch lever farther away from the tip of the grip, turn the adjuster screw in a clockwise rotation.
3. To make the position of the clutch lever closer to the tip of the grip, turn the adjuster screw in a counter-clockwise rotation.
4. Once you are comfortable with the position of the lever, tighten the lock nut securely.
5. **FREE-PLAY: 10mm-20mm (0.4-0.8 in.)**

B. Cable End Adjustment (free-play)

Minor adjustments are generally made with the clutch cable end adjuster.

1. Turning the cable end adjuster **(A)** in the **(B)** direction will increase the free-play.
2. Turning the cable end adjuster **(A)** in the **(C)** direction will decrease the free-play. If the adjuster is threaded out near its limit or the correct free-play cannot be reached, turn the adjuster all the way in and back in out one full turn and make the adjustment with the integral cable adjuster on the engine.

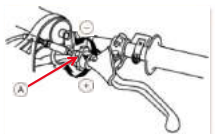
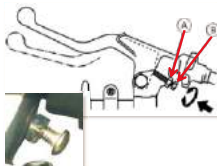

Make sure the gear is in Neutral. Start the engine and pull the clutch lever in and shift into gear. Make sure the engine does not stall and the motorcycle does not creep. Gradually release the clutch lever and open the throttle. Your motorcycle should now move smoothly and accelerate gradually.

If you can't get the proper adjustment, or the clutch does not work properly, the cable might be kinked or worn out or the clutch friction discs may be worn out. Take to your local dealer for inspection.

BASIC MAINTENANCE PROCEDURES

The recommended standard spark plug will work very well in most riding condition. However, if you plan on riding for extended periods of time at high speed or high engine rpm in hot climates, or plan extended riding in cold climates, a different plug may be recommended.

Standard - U24ESR-NB (DENSO)

Use only the recommended type of spark plug.

SPARK PLUG

A fouled (dirty) spark plug can cause your H7L to run poorly and lose performance. Follow the steps below to inspect, clean and/or replace the spark plug if needed.

1. Clean any dust or dirt from around the spark plug base area thoroughly to prevent dirt from entering the cylinder.
2. Disconnect the spark plug cap.
3. Remove the spark plug.
4. Using the photos below for a reference, examine the spark plug to determine its cleanliness. If the plug has a normal color, GO TO STEP 6. If the spark plug is fouled (dirty), GO TO STEP 5.
5. Using a moderate grit sandpaper (220-400), sand between the center electrode and the side electrode until all carbon and oil deposits are removed. We recommend that you use a spark plug cleaner or a new spark plug is the old spark plug is very dirty.
6. Check the electrodes for wear or deposits, the sealing ring for damage and the insulator for cracks or chips. The center electrode should be nicely rounded or have square edges (depending on the type of spark plug you are using) the side electrode should not be eroded at all. Replace the spark plug if you detect either.
7. Check the spark plug gap using a wire type feeler gauge. If the gap is not as specified, replace the spark plug with a new one. **RECOMMENDED SPARK PLUG GAP: 0.6 – 0.7 mm (0.025 – 0.029 IN.)**
8. Be sure all dirt has been cleaned from the threads if you are using he old spark plug. Install the spark plug by hand first. This will prevent stripping and/or cross threading the threads. Use the appropriate socket or wrench to securely tighten the spark plug. Do not over or under tighten the spark plug.

4. Tightening the spark plug:

A. If using the old spark plug:

1. 1/8 turn after it seats.

B. If using a new spark plug:

1. First, tighten the plug 1/2 turn after it seats.
2. Then loosen the spark plug.
3. Next, tighten the plug again: 1/8 turn after it seats.

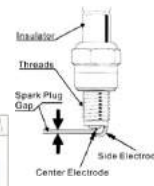

When you inspect the spark plug, generally it will fit into one of the four categories shown above. A normal/clean spark plug will have a light brown center and displays no wear around the electrodes. A spark plug with a bright white center indicates a lean condition in the engine. If your plug looks like this, have your motorcycle serviced by your Zuumav dealer immediately. A carbon fouled plug will be completely black with no gloss. An oil fouled plug will appear a dark shiny brown or shiny black as shown above. An oil fouled plug is caused when the engine oil seeps by the piston ring and is burned with the fuel. Oil fouled plugs are not uncommon, however, if your motorcycle is consistently oil fouling spark plugs, have it serviced by your local dealer immediately.