

How to install your  
Cordless PVC Venetian Blind

#65101-20146-D









Difficulty: ★☆☆☆☆

Required Tools

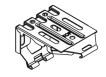

Included Hardware

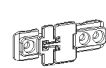
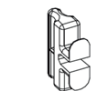
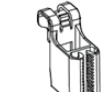
The hardware can be found in the end of every box.

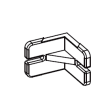
-  Installation Bracket
-  Hold Down Bracket
-  Medium & Long Screws for Wood
-  Wall Plugs for Brick or Cement using a 6mm Bit (if requested)
-  Valance Connector (Optional)
-  Clip Plug (Optional)
-  Clip Receptor (Optional)
-  Wand
-  Valance Return Connector (Optional)

1 Installation Brackets

Installing inside the window frame...

- At the top of the window frame measure 85mm in from each side and measure 68mm (102mm for blind with valance) back from the front of the window opening; this is the edge of the back of the bracket.
- Place bracket in position and mark where the screws will go.
- We recommend drilling pilot holes for the screws using a 2mm bit.
- Use the double sided tape from the hardware box and stick the brackets at the marked location for easy installation if needed, then fix bracket into position using 2 long screws.
- If more brackets are supplied, space them evenly between the first two brackets.

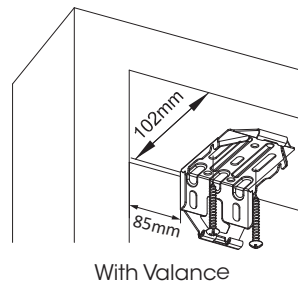
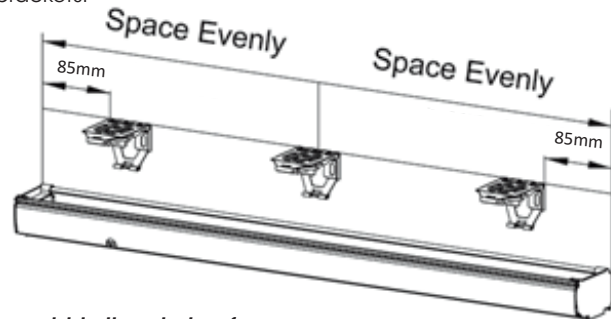
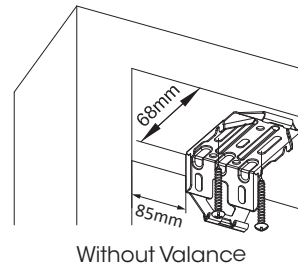

Installing outside the window frame...

- Measure 85mm in from the top left and top right of where the blind will be positioned and 45mm up from the top of the window opening; this is the edge of the top of the bracket.
- Place the brackets in position and mark where the screws will go.
- We recommend using a spirit level to align brackets if not installing on the architrave.
- We recommend drilling pilot holes for the screws using a 2mm bit.
- Use the double sided tape from the hardware box and stick the brackets at the marked location for easy installation if needed, then fix bracket into position using 2 long screws.
- If more brackets are supplied, space them evenly between the first two brackets.

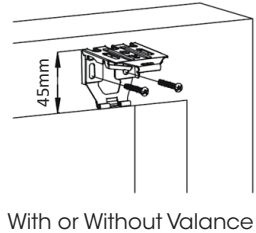

2 Install Blind

- Position the top front of the blind under the top front lip of the brackets.
- Push the blind up at the back and click into position as per diagram.
- Ensure the blind has clicked firmly into place.

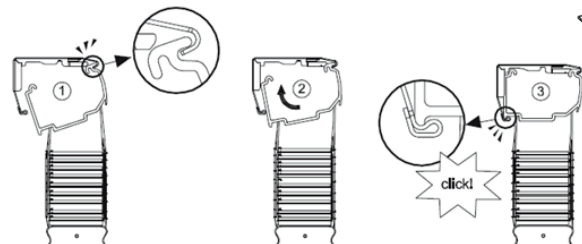
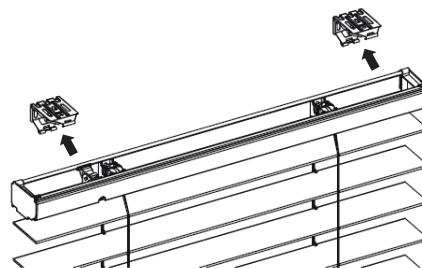

How to install your  
Cordless PVC Venetian Blind

#65101-20146-D



Installation continued...

3 Install Valance Connector (Optional)

Valance Connector is only supplied for connecting spliced valances. Insert the valance connector into the slot on the back of the valance as below drawing:

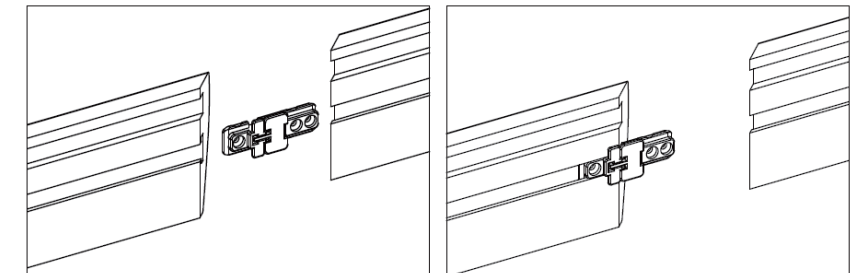

The valance is connected as below drawing:

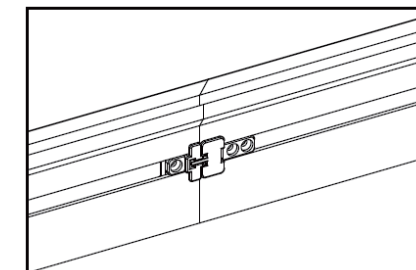

4 Attach the Valance (Optional)

Hook the adjustable valance clip receptors onto the headrail and space them evenly. Make sure receptors are not in an obstructive position with the drum support or wand filter inside the headrail and the brackets.

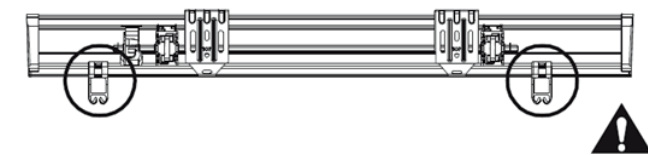

Attach the adjustable valance clip plug into the channel on the backside of the valance. Refer to the receptor position on the headrail to decide where to position on the valance.

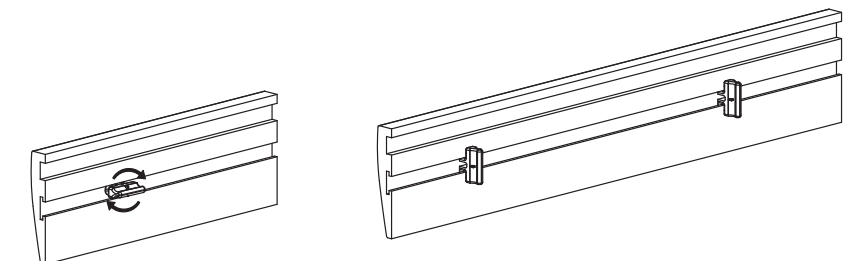

# Cordless PVC Venetian Blind

#65101-20146-D



Installation continued...

Attach the valance return connector if needed (Outside Mount).

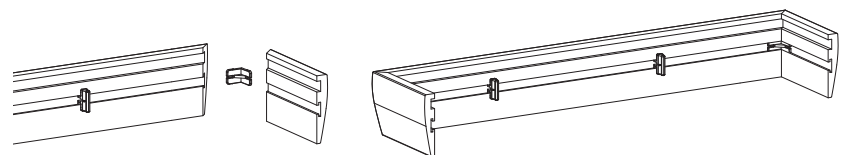

Attach the valance to the headrail by inserting the plugs into the receptors. Refer to the right drawing. Slightly move the receptors left or right along the headrail so the plugs are in alignment with receptors to ensure right insertion of plug.

If you wish to adjust the valance position vertically, pull out the valance and reinsert into the desired position. When removing the valance from the headrail, hold the valance as shown on the picture and pull it out (do not flip upward).

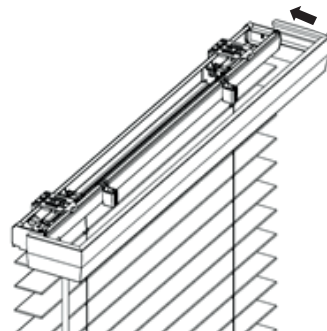
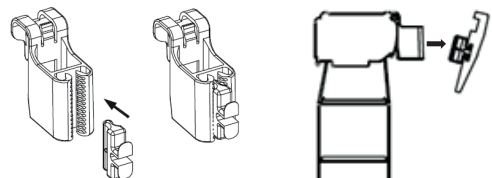

## 5 Hold Down Brackets

### Installing inside the window frame...

- Position hold down bracket vertically inside window frame where the bottom rail hangs naturally, mark where the 2 screws will go.
- We recommend drilling pilot holes for the screws using a 2mm bit.
- Fix bracket into position using 2 medium screws.
- Insert bracket knob into bottom rail.
- Repeat for bracket at other end of bottom rail.

Inside Mount

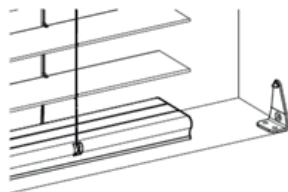

### Installing outside the window frame...

- Position hold down bracket horizontally outside window frame where the bottom rail hangs naturally, mark where the 2 screws will go.
- We recommend drilling pilot holes for the screws using a 2mm bit.
- Fix bracket into position using 2 medium screws.
- Insert bracket knob into the bottom rail.
- Repeat for bracket at other end of the bottom rail.

Outside Mount

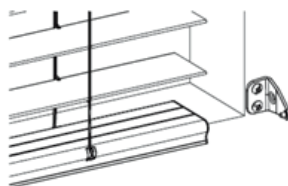

## 6 Assemble the Wand

- Insert wand tilt connector into the bottom of headrail till they are clicked.
- Do not take down the wand after installed.

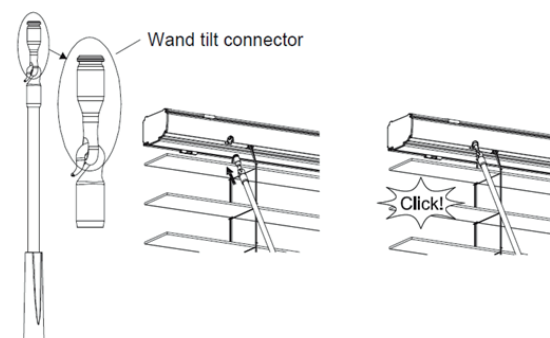

Great Job... Enjoy your new Veneta Blinds!

# Cordless PVC Venetian Blind

#65101-20146-D



Operating your Blind

- Rotate wand to attain desired slat position.
- The slats need to be opened at any angle and kept even when pulling the bottom rail down by hand.
- Gently tilt the slats level before lifting the bottom rail up by hand.
- Note: Do not put the slats in a closed up or closed down position while lifting the bottom rail.

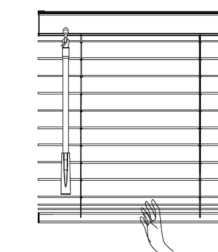
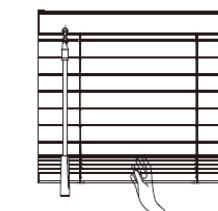

Maintaining your Blind

## 1 Removing your Blind

- Remove the valance and valance clip plugs away from the receptors first if valance is included.
- Remove the blind from brackets as per picture below.

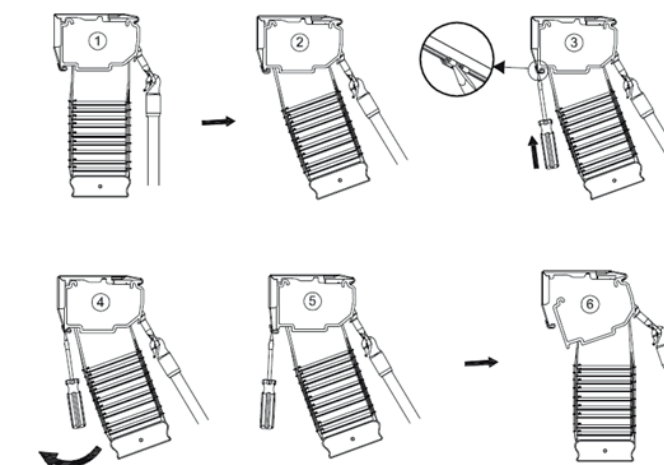
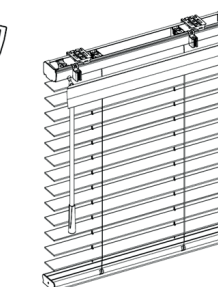
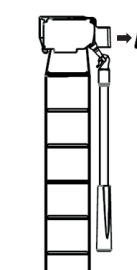

Feedback?

We would love to know how you went with your installation...

Please write a review on our website at...

[www.venetablinds.com.au](http://www.venetablinds.com.au)

## 2 Dusting

- Dust can be removed using a feather duster or vacuum with brush attachment on low suction.

## 3 Spot Cleaning

- Clean your PVC Venetians using a warm damp cloth.
- Do not use solvents or chemicals.

Need HELP?  
Customer Service  
**1800 836 382**

"the best compliment  
you can give  
is a referral"