

iGO



eXtreme 3.1

USER MANUAL

PLEASE READ THIS MANUAL BEFORE OPERATING

AND WATCH THE FULL ASSEMBLY
INSTRUCTIONAL VIDEO AT:

www.iGOelectric.com/buildmyextreme3

IF YOU HAVE ANY ISSUES WITH YOUR BIKE PLEASE
DO NOT RETURN TO PLACE OF PURCHASE

PLEASE CALL

iGO Customer Service / Technical Support Toll-Free Number

1 866 996 6686

Mon - Fri 9:00 am - 5:00 pm EST

PLEASE READ THIS MANUAL BEFORE OPERATING

AND WATCH
THE FULL ASSEMBLY
INSTRUCTIONAL VIDEO AT:

www.iGOelectric.com/buildmyextreme3

CAN ICES-002 (B) / NMB-002 (B)

FRAME NUMBER / VIN NUMBER

The frame number is located near the bottom bracket (as shown).

You can now register your bike at:
register.igoelectric.com



ATTENTION! Your ebike may differ from the illustrations in this manual.



iGO highly recommends having the ebike assembled and adjusted by a professional bicycle technician.

Note:

iGO Electric reserves the right to make changes without notice to design(s) and / prices listed in this manual. This manual has been compiled with great care. iGO can not be held responsible for any inaccuracies whatsoever.



CONGRATULATIONS !

You are the proud owner of an iGO electric ebike. We have taken great steps to create an incredible product and hope you enjoy riding it as much as we did creating it. With the help of our electric bike your riding experiences will be extremely pleasurable and memorable and hope you will explore many new surroundings. The ebike is equipped with electronic pedal assistance which guarantees a completely new way of cycling. Whether you use the ebike for commuting, shopping or just a leisurely ride, you will do so comfortably and confidently on your new iGO.

Chances are that you have not previously owned an electric bike with pedal assistance. For that reason iGO has compiled a comprehensive user guide for you. iGO encourages you to read through it carefully before riding your new ebike to obtain a full understanding of your bikes features.

For more information, please visit our website at www.igoelectric.com.

We wish you many happy rides with your new ebike.

Sincerely,

iGO

T: 1 866 996 6686
@: support@iGOelectric.com

ADDRESS: 1300, 55TH AVE.
Suite 100
LACHINE, QC
CANADA
H3T 3J8

TABLE OF CONTENTS

DISPLAY & FUNCTIONS	6
BUTTONS	6
INFORMATION ON THE SCREEN	7
CONTROLS	8
SETTINGS MENU	10
ERROR CODES	11
PEDAL ASSISTANCE	12
WHAT IS PEDAL ASSISTANCE?	12
TURNING PEDAL ASSISTANCE ON/OFF	12
DERAILLEUR FUNCTIONS	12
MORE INFORMATION ON PEDAL ASSISTANCE	13
BATTERY & CHARGING	14
BATTERY RANGE	14
DISCONNECTING AND REMOVING THE BATTERY	15
CHARGING THE BATTERY	16
USING THE BATTERY AS A POWER SOURCE	16
WHAT YOU SHOULD KNOW ABOUT YOUR BATTERY	17
HOW TO STORE YOUR BATTERY DURING NON USE	18
ADJUSTING YOUR ELECTRIC FAT BIKE	19
INSTALLING & ADJUSTING YOUR HANDLEBARS	19
ADJUSTING YOUR SADDLE POSITION	20
ADJUSTING YOUR SEAT HEIGHT	20
INSTALLING FRONT LIGHT & FENDER	21
ALIGNING THE BRAKES	22
ADJUSTING THE BRAKES	22
GEARS	23
TRIGGER SHIFTER	24
TIRE PRESSURE	25

MAINTENANCE	26
SERVICING	26
GENERAL MAINTENANCE	26
CLEANING	27
MOVING AND STORAGE INSTRUCTIONS	27
WARRANTY INFORMATION	28
WARRANTY	28
WARRANTY LIMITATIONS	28
WARRANTY TERMS	29
REGISTER YOUR BIKE	31



**PLEASE READ IMPORTANT BATTERY STORAGE
INFORMATION ON PAGE 18**

**IMPROPER STORAGE OF YOUR BATTERY COULD RESULT
IN TOTAL BATTERY FAILURE**

DISPLAY & FUNCTIONS

The battery must be in the ebike for the display to function.
Make sure that the battery is locked into the battery rack.
It is not necessary to keep the key in the lock while riding

Turn the power on by pressing the 'POWER' Button for 2 seconds.

BUTTONS

'POWER': Powers ebike ON/OFF

'MODE': Toggles through display modes

'PLUS': Pedal assist level up, Turns on lights when held for 2 seconds

'MINUS': Pedal assist level down, Walk assist when held



DISPLAY & FUNCTIONS

INFORMATION ON THE SCREEN



SPEED
(km/h or mph)



ASSISTANCE LEVEL
(0 - 9) Mode 0 = No assistance



BATTERY INDICATOR
5 Bars = Full Battery

ODO

ODOMETER
Total distance traveled

TRIP

TRIP ODOMETER
Distance traveled since last reset

TIME

TIMER
Time since ebike was last turned on



LIGHT INDICATOR
Appears when lighting system is turned on



FAILURE
See page. 11 for error code descriptions

DISPLAY & FUNCTIONS

CONTROLS

Turning the ebike ON/OFF

Press and hold the 'POWER' Button for 2 seconds to turn the electric system on or off. The control panel can only be used when the battery is connected to the ebike. If the system is not used for a duration of 5 minutes, it will shut itself off to conserve battery.

Selecting the display mode

Short press the 'MODE' button to cycle through the different modes of the display. Speed/Avg. Speed/Max. Speed/Trip Distance/ODO/Time.

Adjusting the pedal assistance levels

Use the 'PLUS' and 'MINUS' buttons to select the different levels of pedal assistance. (0 - 9).

Power level 9 gives the strongest assistance from the motor.

In power level 0 the motor does not provide any pedal assistance or throttle but you will still be able to use the lights and functions of the display.

NOTE: The battery will run out of power quicker when using a higher level of pedal assistance.

Lighting

With the ebike's power on, hold the 'PLUS' button for 2 seconds to turn on the lighting system. This will turn on the backlight for the display, as well as the front and rear lights. Holding the 'PLUS' button for 2 seconds again will turn the lighting system off.

NOTE: The lighting system is powered through the ebikes lithium-ion battery.

Walk Assist

Hold down the 'MINUS' button to initiate walk assist mode. The bike will move at a steady pace of 6km/h - intended to facilitate walking with the bike up ramps or light slopes, parking etc. until the 'MINUS' button is released.

DISPLAY & FUNCTIONS

CONTROLS (Cont'd)

Throttle

Your bike is equipped with an on demand throttle on the left grip. The throttle can only be used within pedal assist levels 1 through 9. Level 0 is for conventional non electric riding. Regardless of the power assist level you select the throttle is capable of taking you to top speed. You can use the throttle along with the pedal assist or on its own.



Display unit and throttle located on left handlebar

USB Charging Port



A 5V/500mA USB charging port is located on the right side of the display unit. When the display unit is powered on this port can be used to provide charge to electrical devices such as a mobile phone. The Port is covered by a weatherproof rubber seal.

DISPLAY & FUNCTIONS

SETTINGS MENU

Press and hold the 'MODE' Button for 2 seconds to enter the Settings Menu. The Settings Menu will allow you to change certain parameters of your ebike.

Once in the Settings menu the word mode display will begin to flash, pressing the 'Mode' button will allow you to cycle through the different settings. The 'PLUS' and 'MINUS' buttons will allow you to change the values of those settings.

Holding the 'MODE' button again for 2 seconds will save the settings and exit the Settings Menu.



RESET SPEED AND DISTANCE

Press 'PLUS' or 'MINUS' and toggle to 'y' to reset average speed / max speed / trip / time.

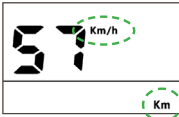

SYSTEM

Press 'PLUS' or 'MINUS' to toggle between metric / imperial.



BRIGHTNESS

Press 'PLUS' to increase the display brightness or 'MINUS' to decrease the display brightness (1 - 5).



AUTO OFF

Press 'PLUS' or 'MINUS' to change the length of time before the display powers off - to conserve energy. (Chose from 1 to 15 minutes or '0' to disable this feature.)



WHEEL SIZE

Press 'PLUS' or 'MINUS' to change the wheel diameter.

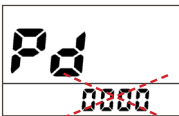

MORE

(Password protected) functions within this section are not programmed by the consumer.

To quit the parameter settings menu press (and hold) the 'MODE' button on the bottom of the display for 2 seconds.

DISPLAY & FUNCTIONS

ERROR CODES



If an issue should occur with your iGO eXtreme ebike an error code will appear on your display.

In the event of an error code, verify all electrical connections

- 1) at the wiring between the handlebars and the downtube of the bike, and
- 2) on the left chainstay, between the motor and the controller.

Error 04:	Throttle
Error 06:	Low Voltage Protection
Error 07:	High Voltage Protection
Error 08:	Hall Sensor
Error 11:	Phase Line
Error 10:	Controller Temperature
Error 12:	Current Sensor
Error 13:	Battery Temperature Sensor
Error 21:	Speed Sensor
Error 22:	BMS Communication
Error 30:	Communication

If error persists contact iGO Technical Support

iGO TECHNICAL SUPPORT (*phone lines open Mon-Fri 9:00 am - 5:00 pm EST*)
tel: 1 866 996 6686 email: support@iGOelectric.com



**YOU MUST ALWAYS WEAR AN APPROVED BICYCLE HELMET
WHEN RIDING AN ELECTRIC BIKE.**

PEDAL ASSISTANCE

WHAT IS PEDAL ASSISTANCE?

The bike is equipped with 9 levels of electronic pedal assistance.

As you pedal, the motor will assist you and enhance your pedaling effort. This will allow you to pedal much further and faster but use much less energy and effort. It is also a great feature when climbing a hill, as the motor will help to make any climb easy.

TURNING PEDAL ASSISTANCE ON AND OFF

When you turn on the power to the display, the pedal assistance will automatically default to level 0. By using the 'PLUS' and 'MINUS' buttons, you can increase or decrease the level of assistance. You can turn off the assistance completely by pressing the 'MINUS' button until the level of assistance is at level "0". This will allow you to use the lights and functions of the display, but ride the bicycle without any pedal assistance from the motor.

Pedal assist levels 1-5 are meant to be used more on flat roads or paths, the higher levels (6-9) are more powerful and meant for hills, headwinds, or heavy loads.

If you prefer to ride slowly, it would be more comfortable for you to ride in a lower power level. If you prefer to ride faster, then you should increase the power level.

DERAILLEUR FUNCTIONS

Your bike is equipped with a Shimano Altus 8 speed derailleur. Please choose the proper gear to match the riding terrain.

The use of a proper gear along with pedal assist or conventional power will enhance your riding experience

We recommend checking your derailleur functions at least once a month. If you are not capable of adjusting the derailleur your local bike store can help.

PEDAL ASSISTANCE

SAFETY PRECAUTIONS WHILE USING THE PEDAL ASSIST & ON DEMAND THROTTLE

- Since the motor is assisting you, you will easily reach higher speeds than you might be used to. We recommend that you ride the bike in a minimal traffic area at first to become more comfortable with it.
- The operation of the pedal assistance depends on the speed at which the pedals are rotated and your cycling speed.
- The electric motor speed is limited to a speed of 32 Km/h (20 mph). This means that as you exceed this speed electrical assistance stops and returns when speed returns to 32km/h (20 mph)
- The level of pedal assistance will affect the battery range. Battery range is dependent on many factors which are measured under average conditions. It is dependent on, but not limited to, rider weight, speed, elevation, tire pressure, wind, start-stop frequency, and outside temperature.



ATTENTION! Remember that acceleration will be much quicker with pedal assistance.



ATTENTION! Make sure to turn off the power when walking next to, mounting, or dismounting the bike.



ATTENTION! Hold both brakes when stationary.



**YOU MUST ALWAYS WEAR AN APPROVED BICYCLE HELMET
WHEN RIDING AN ELECTRIC BIKE.**

BATTERY & CHARGING

BATTERY RANGE

How far can I travel on my electric bike?

The total distance you can travel on your electric bike is not an easy amount to specify. The range depends on many different factors including, but not limited to:

- Total Weight (weight of the bike + rider + cargo)
- Resistance (wind, tire pressure, speed, road conditions and altitude)
- Outside Temperature
- The level of pedal assistance and throttle usage
- The condition of the battery
(battery capacity decreases as the battery ages)

Battery Capacity

Batteries are often compared based on capacity - Amp hours (Ah). However, a comparison based on capacity alone does not properly depict a battery since the performance of a battery pack is also based on battery voltage (V). The best way to compare battery performance is by looking at the amount of energy that can be used in watt-hours (Wh). Wh take into account both the capacity of the battery, as well as the average voltage during discharge. Simply put, the higher the V/Ah, the higher Wh range!

Watt hours calculation :

$$\text{Battery voltage (V)} \times \text{Amp hours (Ah)} = \text{Watt hours (Wh)}$$

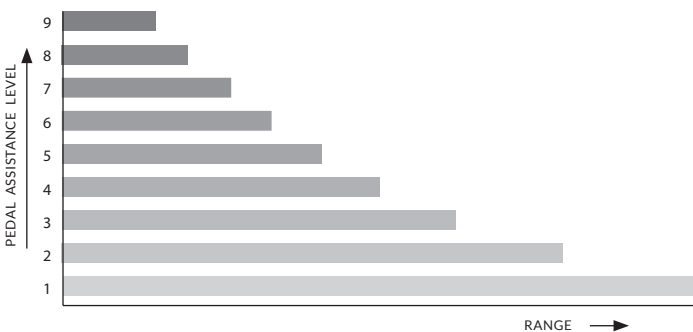

BATTERY & CHARGING

DISCONNECTING & REMOVING THE BATTERY



On the top-right side of the downtube is the battery lock. This lets you lock/unlock the battery pack of the bike.



To Lock:

Insert the bottom of the battery into its receptacle on an angle as shown while pushing the top of the battery into the lock until an audible click is heard.

Ensure the battery is secure by attempting to gently turn the key in the lock. When installed correctly there should be no 'give' (the key will not turn).

To Unlock:

Insert the key into the lock and turn 1/4 turn clockwise.



ATTENTION! Ensure the battery is fully secure and locked in place when installing to avoid it ejecting while riding.



ATTENTION! Always remove the key while riding.

BATTERY & CHARGING

CHARGING THE BATTERY



Fig. 16.1

The battery can be charged both on and off of the bike.

Please identify your charging port (figure 16.1).

First plug the charger's male plug into the battery, then plug the charger's 110 volt plug into your wall outlet. (Do not use an extension for 110 volt.)

The indicator on the charger will light green for a few seconds and if a charge is necessary, the LED will turn red. The battery is fully charged when the battery indicator LED becomes green.

Unplug the charger from the wall first, and then from the battery.



Fig. 16.2

Battery Status

Press and hold the button (figure 16.2)

Red Needs Charge

Green 50%

Blue 100%



ATTENTION! When the battery is completely depleted you must charge it immediately. If the cells are left depleted for a long period of time, they may become irreparably damaged.



ATTENTION! The battery will sustain permanent damage if not used for a long period of time (ex: Winter storage). SEE PAGE 18 Make sure to charge the battery once a month during this time.

BATTERY & CHARGING

WHAT YOU SHOULD KNOW ABOUT YOUR BATTERY

- DO NOT open your battery as it will void warranty.
- The battery should be recycled properly at the end of its life.
- The performance of the battery will decrease at low temperatures. The ideal operating temperature is approx. -10°C to 50°C. The guideline is that the capacity will decrease by 1% at every 1°C of temperature drop.
- The battery is intended to be charged when the ambient temperature is between 0°C (32°F) and 30°C (86°F). Never charge the battery when ambient temperatures are outside this range.
- Under ideal conditions, the battery pack can be recharged approximately 750 times. The performance will slowly decrease over time and eventually will need to be replaced.
- For long term storage see storage info page 18.
- Use ONLY the supplied charger.



ATTENTION! Make sure to only charge the battery in a dry, well ventilated area.



ATTENTION! The socket-outlet shall be installed near the equipment and shall be easily accessible.



ATTENTION! Unplug the charger when the battery is fully charged, or when charger is not in use.



ATTENTION! Only use a charger supplied or recommended by the manufacturer.

BATTERY & CHARGING



IMPORTANT BATTERY STORAGE INFORMATION

When not using your bike for periods exceeding one month please charge as follows:

1. Before storage make sure that the battery is not charged more than 50% so that it will accept a periodic charge.
(You cannot periodically charge a fully charged battery)
2. Once every month you must attach the supplied battery charger and charge for a period of no more than 15 minutes.
3. Continue this procedure once a month until more frequent riding.

This process will make sure that your battery does not stay at a specific rate of charge for long periods of time.



ATTENTION! Please recycle your battery at an authorized recycling company in your area.



ATTENTION! Battery is not intended for use at elevations greater than 2000 m above sea level.



ATTENTION! Prolonged Exposure to UV Rays, Rain and the Elements May Damage the Enclosure Materials, Store Indoors When Not in Use

ADJUSTING YOUR ELECTRIC FAT BIKE

INSTALLING & ADJUSTING YOUR HANDLEBARS



Fig. 19.1

Using the 5mm allen key take off the 4 front bolts of the stem as shown in figure 19.1



Fig. 19.2

Place handlebar in position on stem and using 5mm allen key tighten bolts as shown in figure 19.2.

Make sure to attach all bolts one at a time in order from 1 to 4 as shown but don't fully tighten until all bolts are installed (tighten to 5Nm - 6Nm)



Fig. 19.3

The handlebar position can be altered by adjusting the angle of the stem. Using a 5mm allen key loosen the bolt shown in figure 19.3

Move the stem to the desired angle and then retighten the bolt (tighten to 13Nm)

ADJUSTING YOUR ELECTRIC FAT BIKE

ADJUSTING YOUR SADDLE POSITION

You can tilt the saddle to change the seating angle, as well as, slide it backward or forward (figure 20.1). To adjust the saddle, loosen the nut located on the underside of the saddle with an allen key (figure 20.2). You will be able to move the saddle around to suit your preferred riding style. When you are done adjusting, make sure to retighten the nut.

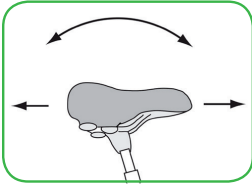

Fig. 20.1

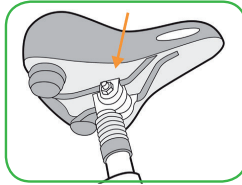

Fig. 20.2



ATTENTION! Ensure that the safety marks for max. height written on the seat post are not visible when retightening the hex bolt.

ADJUSTING YOUR SEAT HEIGHT

Your seat height should be adjusted properly to ensure you get the most comfortable ride possible. The seat height is properly adjusted when your knee has a slight bend when sitting on the saddle with your foot on the pedal at its lowest position (figure 20.3). The seat height can be adjusted by loosening the lever on the seat tube clamp figure 20.4. Make sure to retighten after adjustment.

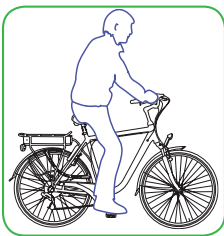

Fig. 20.3



Fig. 20.4

ADJUSTING YOUR ELECTRIC FAT BIKE

INSTALLING FRONT LIGHT & FENDER

Full instructions for installing the light and front and rear fenders are shown in the installation video at:

www.iGOelectric.com/buildmyextreme3



Front fender & light



Rear fender



ATTENTION! If you can put your feet flat on the ground while seated, your seat height is too low.

ADJUSTING YOUR ELECTRIC FAT BIKE

ALIGNING THE BRAKES

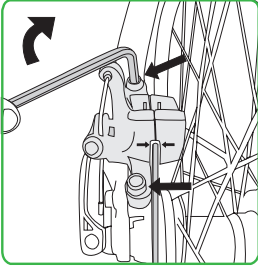

Fig. 22.1

Your electric bike is equipped with a disc brake system. To properly adjust them you must first make sure that the brake disc is properly aligned within the brake caliper. To do this, loosen the top and bottom hex bolts (figure 22.1) with an Allen key. Then maneuver the brake with your hand so that the disc passes through the brake pads with minimal contact. Once the disc rotates through the brake freely, retighten the hex bolts and make sure that while tightening you maintain the alignment.

BRAKE BED IN PROCEDURE

Properly bedding in your brakes will increase the lifespan of the pads, reduce noise and increase the braking power. Before your first ride, perform this procedure to properly condition the brake pads and rotors.

- 1) Accelerate to a medium speed (approx. 20 km/h), then firmly apply the brakes and reduce your speed to a walking pace. Repeat approximately 20 times.
- 2) Accelerate to a higher speed (approx. 32 km/h), then firmly and quickly apply the brakes, reducing your speed to walking pace. Repeat approximately 10 times.
- 3) Let the brakes cool before setting off on your first ride.

ADJUSTING HYDRAULIC DISC BRAKES

The hydraulic brake system on your iGO electric bike is self adjusting, and will not require manual adjustment during normal operation.

If you pull the brake lever and the pads don't stop your bike, you probably have air in your brake line. Unless you have bled brakes before we strongly suggest this be done by a professional bike mechanic.

ADJUSTING YOUR ELECTRIC FAT BIKE

GEARS

Your eBike comes equipped with a Shimano Altus 8 speed drivetrain. The trigger shifter mounted to your right handle will allow you to change gears. It is important that you only change gears while pedaling as the chain must be in motion to properly shift gears.

Understanding when and how to shift gears on any bike will lead to a smoother riding experience and avoid unnecessary damage to components due to excessive strain. On an electric bike efficient use of gears may also help to maximize your battery range.

Shifting gears is done so that you can maintain a constant and comfortable pedalling speed (cadence), no matter how fast you are riding. As you move faster you will want to use the shifters to 'shift up' into higher gears to stop your legs spinning too fast. As your riding speed is reduced you will want to 'shift down' to lower gears so you do not have to exert excessive pressure on the pedal to keep moving. When coming to a stop it is recommended to 'shift down' to a lower gear. This positions the drivechain so you will always be ready to move off again in a lower (easier) gear and gradually 'shift up' through the gears as you increase speed allowing you to safely gain momentum, traction and balance.

Ideally, scan the road ahead and anticipate your shifts. This will ensure that you are in the correct gear when you need it, and avoid any problems with shifting under difficult conditions.



Always pedal forwards while shifting, the chain needs to be moving in order to perform the gear shifts.

Try to avoid extreme strain on the chain when shifting, if you are pedalling very hard (uphill or strong accelerations), ease up on the pedals slightly while continuing to pedal.

ADJUSTING YOUR ELECTRIC FAT BIKE

RIGHT SIDE TRIGGER SHIFTER

There are 2 levers on the shifter, A and B (figure 24.1)

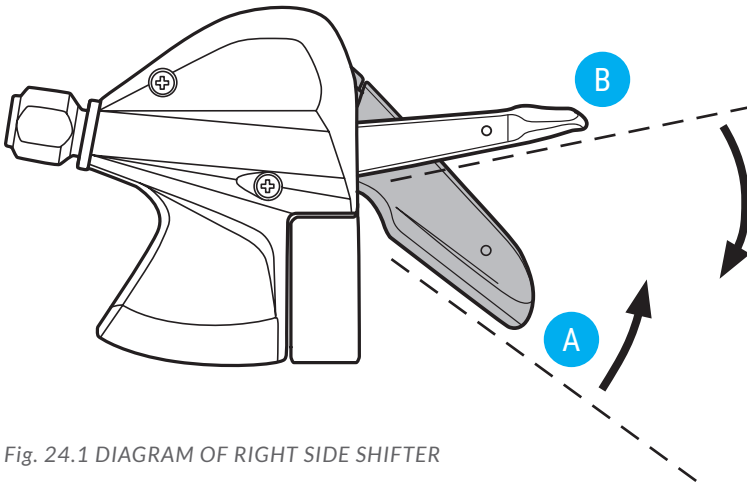

Fig. 24.1 DIAGRAM OF RIGHT SIDE SHIFTER

Push lever A with your thumb to 'shift down' when pedalling is too difficult. This will move the chain to a larger gear on the rear wheel, and the indicator on the shifter will show a lower number. Pedalling will be easier.

When speed increases and you are pedalling too fast, pull the lever B with your index finger to 'shift up'. This will move the chain to a smaller gear on the rear wheel, and the indicator will show a higher number. Pedalling will be harder.

ADJUSTING YOUR ELECTRIC FAT BIKE

TIRE PRESSURE

The tire pressure will affect the range and comfort of your bike .

Your eBike comes equipped with the Kenda Juggernaut Sport Fat tire, 26" x 4.5" which are capable of operating on 5 psi to 30 psi of air and can be adjusted to best suit any terrain.

The tire pressure is measured in P.S.I. (Pounds / Square Inch).

Make sure to use a tire pressure gauge when pumping your tires to fill the proper amount of air.



ATTENTION! Riding on deflated / soft tires will severely reduce the range of the battery.

For detailed assembly and installation guides
watch the full instructional video at:

www.iGOelectric.com/buildmyextreme3

MAINTENANCE

SERVICING

Servicing your bike is very important. You can avoid unnecessary damage by servicing your bike regularly.

In the paragraphs that follow, there are some simple tips you can follow at home to keep the bike running at top performance.

GENERAL MAINTENANCE

- Check tire pressure regularly
- Check brake wear every month and adjust
- Clean and Lubricate the chain occasionally
- If caught in the rain ensure bike and electrical components are wiped dry, remove battery and allow to dry over night
- It is recommended to have your bike evaluated every 3 months by a professional bicycle technician



BEFORE EVERY RIDE

- Make sure battery is charged and locked into position
- Check tire pressure
- Check brakes for proper braking
- Always wear an approved bicycle helmet

MAINTENANCE

CLEANING

Regular cleaning of your ebike will prolong its life and reduce the appearance of rust and corrosion build up.

REMOVE THE BATTERY BEFORE CLEANING and use brushes and wet sponges to remove dirt. Finish by drying with paper cloths / towel. (Use of a mild soap solution, degreaser, chain lube and a chain cleaning device are recommended for a thorough cleaning.)

MOVING AND STORAGE INSTRUCTIONS

Electric bikes can be heavier than non-electric bikes. Ensure any car rack used is certified for use with eBikes and can handle the additional weight when in transport.

As with any bicycle it is encouraged to store your electric bike in a dry temperate environment such as a garage when not in use. Leave indoors when charging or not riding. Prolonged Exposure to UV Rays, Rain and the Elements May Damage the Enclosure Materials, Store Indoors When Not in Use. For long periods of storage the location should protect the bike from extreme heat or cold.

It is advised to remove the battery and store inside during extended periods of storage or during extreme temperature (see page 18 for full battery storage information).

WARRANTY INFORMATION

WARRANTY

iGO Electric warrants to the original retail purchaser ("You"), that the iGO product for which this warranty has been issued is free from defects in material and workmanship for the time detailed below, from the date of original retail purchase. This warranty is not transferable to a subsequent purchaser. iGO's sole obligation under this warranty is to repair or replace the product, at iGO's option.

You have a 12 month warranty on the frame of the bike and electrical components. The battery has a 12 month warranty. There is a 30 day warranty on any manufacturers defects. Not including any wear and tear parts (See P.25, Article 2, Sec.2.5).

Certain warranty conditions may apply, contact your dealer if you have any questions.

WARRANTY LIMITATIONS

The duration of any implied warranty or condition, of merchantability, fitness for a particular purpose, or otherwise, on this product shall be limited to the duration of the express warranty set forth above. In no event shall iGO be liable for any loss, inconvenience or damage, whether direct, incidental, consequential or otherwise, resulting from a breach of any express or implied warranty or condition, of merchantability, fitness for a particular purpose, or otherwise with respect to this product, except as set forth herein. This warranty gives you specific legal rights, and you may also have other rights, which may vary, from location to location.

This warranty will be interpreted pursuant to the laws of Canada. The original English version/meaning of this warranty controls over all translations and iGO is not responsible for any errors in translation of this warranty or any product instructions. This warranty is not intended to confer any additional legal, jurisdictional, or warranty rights to you other than those set forth herein or required by law. If any portion of this warranty is held to be invalid or unenforceable for any reason, such finding will not invalidate any other provision.

WARRANTY INFORMATION

WARRANTY TERMS

Article 1: Guarantee.

1.1 iGO Electric guarantees that the iGO product you have purchased is free from material and/or workmanship faults.

1.2 If, during the warranty period the product proves to be defective due to faulty materials or workmanship, iGO or an iGO Dealer may charge for labor or parts at its own discretion.

The defective products or parts will be replaced using new or refurbished products or parts.

1.3 This warranty applies within the warranty period, and upon presentation of the original invoice or sales receipt (indicating date of purchase, model name, and dealer) together with the defective product. iGO or iGO Dealers may refuse free warranty service if these documents are submitted incomplete or illegible. This warranty is void if the model name or serial number has been altered, deleted, removed, or made illegible. Battery warranty is void if case is opened.

1.4 The guarantee may be invoked by the first owner of the iGO product only.

1.5 This warranty does not cover transportation costs or risks associated with the transport of your product to and from iGO or your iGO Dealer.

1.6 The warranty is void in accordance with Articles 3.1 and 3.2.

Certain restrictions apply in regards to batteries and some electronic parts. Such restrictions are reflected in Article 6.1 and 6.2.

Article 2: Warranty

2.1 You can only make a warranty claim, if you have filled out the warranty card and retained the original proof of purchase. The warranty card is located on the last page of this manual. The warranty period begins on the date of purchase.

2.2 iGO bike frames are guaranteed by design and/or material defects for 12 months.

2.3 All electronic parts, such as electronic controller, control panel, motor, throttle, and pedal assist sensor, are subject to a 12 month warranty if properly maintained.

2.4 The battery is subject to a 12 month warranty if properly maintained.

2.5 On parts that are subject to wear and tear, such as tires, chain, chainring, freewheels, sprockets, cables, and brake pads, there is no warranty on these items, unless there are construction and/or material defects.

Article 3: Warranty Exclusions

3.1 If the following cases occur, then the warranty is void.

a. Incorrect and/or improper use of the iGO product.

b. The iGO product is not maintained in accordance with the guidelines mentioned in this manual.

c. Technical repairs have not been performed properly.

d. Third party components do not match the technical specifications of the bike or were improperly installed.

e. If proof of ownership, proof that the bike has been checked and adjusted properly prior to the customer's receipt of the product, is not present or signed by the seller.

3.2 iGO Electric is free of any liabilities in regards to (parts of) the bike being damaged as a result of:

a. Improper adjustment of the handlebar, stem, saddle, seatpost, gears, brakes, quick release axles of the wheels, and spoke tension.

b. Not replacing worn out parts such as, brake/derailleur cables, brake pads, tires, chains and sprockets.

c. Incorrect or insufficient lubrication of moving parts.

d. Climatic influences such as rust.

e. Any damages occurring during shipment of the product (such claims must be presented directly to the shipper)

WARRANTY INFORMATION

WARRANTY TERMS (Cont'd)

Article 4: Warranty Parts

4.1 During the warranty period, all parts of which iGO has determined of material and/or construction defect, shall be replaced free of charge to the owner. Any costs of (dis)assembly are the responsibility of the owner.

4.2 The owner is responsible for any cost of transport for the iGO Product and/or parts to and from iGO, unless the product or part is still eligible for warranty.

4.3 If a particular component is eligible for warranty and the original is no longer available, iGO will provide an equivalent alternative.

Article 5: Transport of Warranty Products.

5.1 If it is determined by iGO that a bike/part is to be returned to iGO, it must be done in it's original packaging. If the original packaging is not available, an equivalent package must be used to ensure the product is well protected from any damages it may incur during transport.

All original contents such as: keys, charger, battery must be included in the package.

5.2 iGO is not responsible for any damages or loss occurring during shipment of the product, such claims must be presented directly to the shipper by the owner.

Article 6: Additional Warranty

6.1 Warranty on electronic parts:

Electric motor : 12 months, Charger : 12 months, Controller : 12 months, Control Panel : 12 months.

6.2 Additional provisions for the battery/battery pack:

a. iGO Li-ion battery/battery pack has a warranty period of 12 months.

b. Normal wear/decrease in battery capacity is not covered under warranty. The battery will naturally lose capacity over time. Batteries that are left unused/discharged for extended period of time and have become irreparably damaged, are not covered under warranty.

Article 7: Warranty Claims

7.1 Claims under this warranty will only be processed after the iGO Dealer from whom the product was purchased, has inspected the defective bike/part. Proof of purchase and ownership must be present at the time of inspection.

Article 8: Warranty Area

8.1 The warranty area is limited to the United States and Canada.

Article 9: Legal Requirements

9.1 In accordance with North American legislation, the vehicle is described as a bicycle because it complies with the following rules:

- Electronic motor will only assist up to 32 km/h or 20 mph.
- The maximum power output of the motor is under 500W (750W for the U.S.)
- Pedals are permanently affixed to the bike.
- Front and Rear brake handle is equipped with an electronic cut-off switch for the motor power when equipped with an on demand throttle

Article 10: Liabilities

10.1 Although iGO Electric accepts a warranty claim, it does not automatically mean that iGO Electric accepts any liability of any damage suffered.

The Liability of iGO Electric never extends further than is described in this warranty.

Any liability of iGO Electric for consequential damage, is excluded.

WARRANTY INFORMATION

REGISTER YOUR BIKE

In order to service your iGO electric bike, you must first register at register.igoelectric.com to activate your warranty.

Create your Customer Account by entering your information, and clicking "CREATE" at the bottom of the page.

Once in your account, locate and click on the button "Add New Registration". (This will open the Product Registration Form.)

Complete the form and click "Register" at the bottom of the page.

Once your registration is submitted, you will be able to track your warranty by returning to our website igoelectric.com and clicking on the account button at the top-right side of the page.

iGO ELECTRIC BIKES

REMEMBER TO
REGISTER YOUR BIKE

@

register.igoelectric.com

MAIN TECHNICAL PARAMETERS AND SPECIFICATIONS

FRAME	6061 Aluminum 46cm (18")
COLOR	Matte Graphite and Race Red
FORK	RST suspension
SHIFTERS	SHIMANO 8-speed Rapidfire
CHAINRINGS	ZEPHYR 38T
CHAIN	KMC X8 EPT
REAR DERAILLEUR	SHIMANO ACERA 8-speed
CASSETTE	8-speed 11-34T
HANDLEBAR	Riser handlebar, 700mm, 30mm rise, 31.8mm dia.
GRIPS	VELO
STEM	Adjustable threadless with 0 to 60 degree rise
SEAT POST	Alloy 30.4mm with quick release (350mm)
SADDLE	SELLE ROYAL Viento
BRAKE LEVERS	TEKTRO HD-E350
BRAKE CALIPERS	TEKTRO hydraulic disc
ROTORS	180mm
TIRES	26"x4.5" KENDA Juggernaut Sport
RIMS	iGO single wall alloy with cutouts
MOTOR	BAFANG 500W geared brushless hi-torque rear hub
TORQUE	up to 80Nm
CONTROLLER	20A 48V, 12 MOSFET hi-power cut off
BATTERY	3000mAh Cell Lithium-Ion 48V / 12Ah / 576Wh
RANGE	55km (34mi)*
PAS	9 Levels of power assisted pedaling
THROTTLE	Any time on demand thumb throttle
SENSOR	Electronic 32 pulse Cadence Sensor
CHARGER	110/220V Smart charger, LED status, CUL, 2A
CHARGING TIME	4 to 6 hours
CLASS	Class2**
BIKE WEIGHT	30.7kg (67.7 lbs)
BATTERY WEIGHT	3.3kg (7.3 lbs)
WEIGHT CAPACITY	100 kg (220 lbs)

*Actual range may vary depending on Ah of battery rider weight and other riding conditions.

**Electric bike class regulation:

Class 1 - Pedal assist motor with maximum assisted speed 32km/h (20mph)

Class 2 - Pedal assist motor and throttle with maximum assisted speed 32km/h (20mph)

Class 3 - Throttle and/or pedal assist motor with maximum assisted speed 45km/h (28mph)

all classes allow a maximum motor power of 750W(US) or 500W(Canada)

REPLACEMENT PARTS

A list of replacement parts can be found on the iGO website:
www.igoelectric.com/partslist/extreme3

or by contacting:

iGO TECHNICAL SUPPORT (*phone lines open Mon-Fri 9:00 am - 5:00 pm EST*)

tel: 1 866 996 6686

email: support@iGOelectric.com



IMPORTANT SAFETY INSTRUCTIONS

WARNING - When using this product, basic precautions should always be followed, including the following:

- Read all the instructions before using the product.
- To reduce the risk of injury, close supervision is necessary when the product is used near children.
- Do not put fingers or hands into the product.
- Leave indoors when charging or not riding.
- Do not use the charger if the flexible power cord or output cable is frayed, has broken insulation, or any other signs of damage.
- Only use a charger supplied or recommended by the manufacturer.
- The battery is intended to be charged when the ambient temperature is between 0°C (32°F) and 30°C (86°F). Never charge the battery when ambient temperatures are outside this range.
- This equipment is not intended to be used at ambient temperatures less than -10°C (14°F) or above ambient temperatures of 50°C (122°F).



IMPORTANT SAFETY INSTRUCTIONS

CAUTION FOR NIGHT RIDING

1. Check your bike during the day to make sure that your lighting & reflectors are installed correctly checking for looseness, tightening where needed and clean of any debris.
2. Always make sure that the front & rear lighting is operating to its optimal capacity.
3. Wear the right gear. It is recommended to wear reflective gear when riding in the dark. Eye protection such as a goggle, or clear protective glasses will keep any night debris from getting into your eyes.
4. Ride with a buddy. It is recommended to ride with another person as a back up should an emergency arise.
5. Riding conditions at night require a sharper eye. Many obstacles will appear as they are illuminated by the bikes lighting and provide less reaction time so give yourself some extra space between you and your surroundings.

CAUTION FOR WET RIDING

1. Make sure to leave yourself extra stopping time.
2. Be sure to wear the appropriate clothing and protective gear. Wet debris can get kicked up to the rider from the mudguards so please be extra cautious.
3. When accelerating in wet conditions be careful and make sure to increase speed at a slower pace. Don't lean into corners and take more time to brake.
4. Make sure that the appropriate tire pressure is respected. Match the tire pressure to the road & weather conditions. A slightly lower (No less than 5 psi of the recommended pressure written on the sidewall of the tire) tire pressure can provide extra traction in sloppy conditions as more tire surface touches the ground.
5. Always keep an eye on where you're heading. Avoid drain covers, grates, oil, and road lines which can become slippery when wet.



IMPORTANT SAFETY INSTRUCTIONS

GUIDE TO ON-OFF ROAD RIDING

On road riding on flat surfaces is very different from Off road terrain.

1. Understand your terrain. A bike that is equipped and intended for road riding should not be used for off road riding and vice versa. Only use your product for its intended purpose. Failure to comply could result in injury. We cannot be held responsible for anyone riding their bike which is not equipped for the intended terrain.
2. When riding on road conditions make sure to respect the road signage.
3. When riding off road, be sure to familiarize yourself with your surroundings. When riding in hills it is important to understand that riding in these conditions can cause you to become unbalanced which requires quick adjustment. Failure to understand off road riding characteristics can result in injury.
4. Be very careful when riding your bike in snow terrain. A fat tire can be operated with lower tire pressure, so more tire surface is touching the ground. (Only bikes equipped with 26" x 4" or wider tires.) Please see sidewall of tire for proper operating pressure.
5. Off road riding requires greater stopping distances compared to on road riding. Please make sure to adjust brakes, cables, derailleur, and all mechanical functions of your bike with your local certified bike tech as described in this user manual. Failure to comply could result in injury.

IGO
Electric



IGO

1300, 55TH AVE. Suite 100
LACHINE, QC, H8T 3J8
CANADA

support@iGOelectric.com
www.iGOelectric.com