

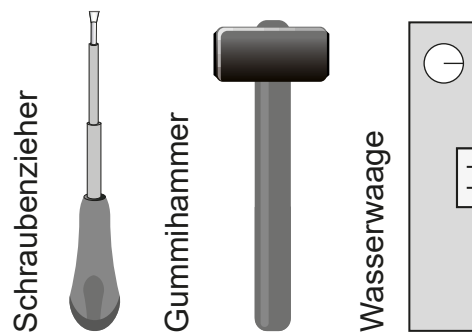

Für die ERREX Montage empfehlen wir zusätzlich



*nicht in Lieferung enthalten

Pfeiler



Fusswinkel

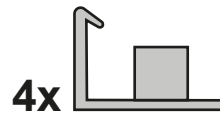

Gewindefuss

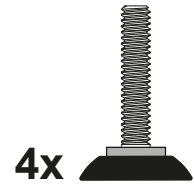

Stabilisierungsplatten

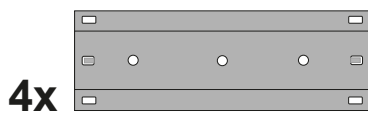

Tablartäger



Metalltablare

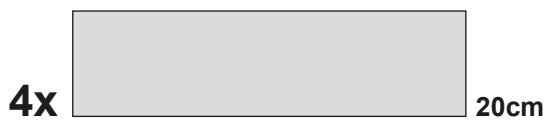

Längsstabilisierung

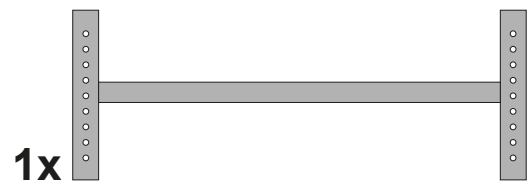

Bohrschrauben

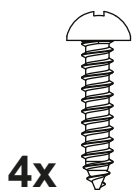

Pfeilerdeckung



1

Fusswinkel in Pfeiler montieren

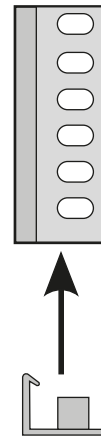

2

Gewindefuss in Fusswinkel schrauben

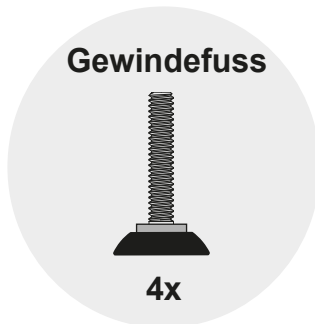

3

Stabilisierungsplatten mit Gummihammer an gewünschter Position in Pfeilerlöcher schlagen

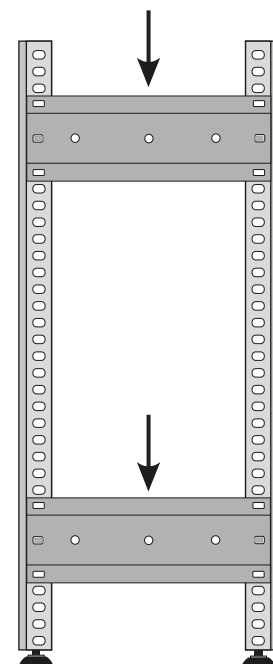
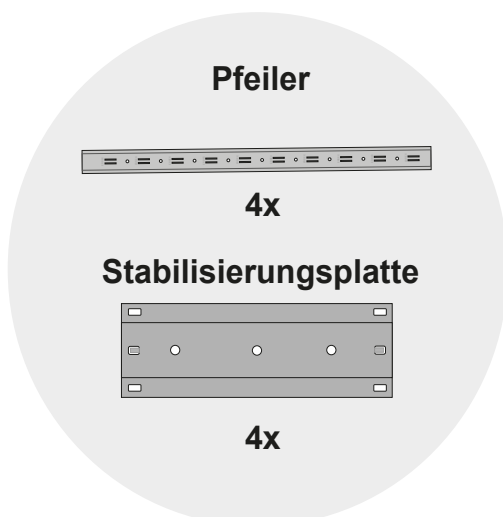

4

Mit dem Schraubenzieher die Sicherungslaschen eindrücken. Damit wird die Stabilität gewährleistet

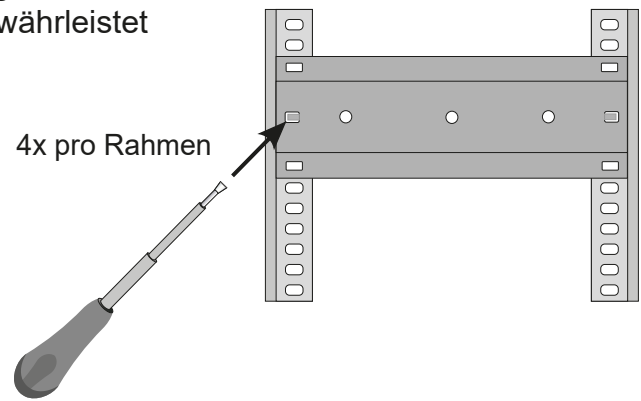

5

Tablarträger in den gewünschten Abständen mit dem Gummihammer einschlagen.

Tipp: Für Ordnerhöhe zwischen den Tablar-etagen, 14 Tablarraster-Abstände am Pfeiler wählen

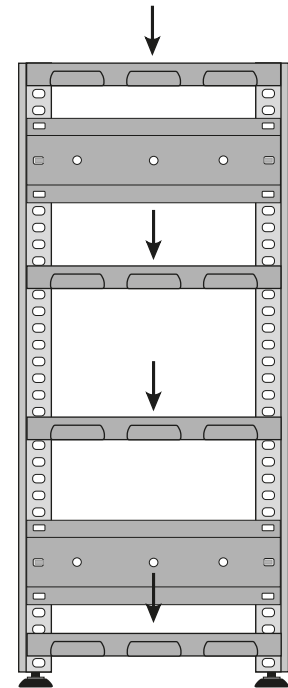
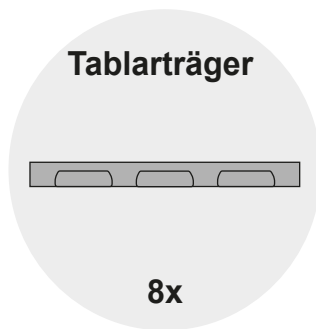

6

Tablare in Tablarträger stecken

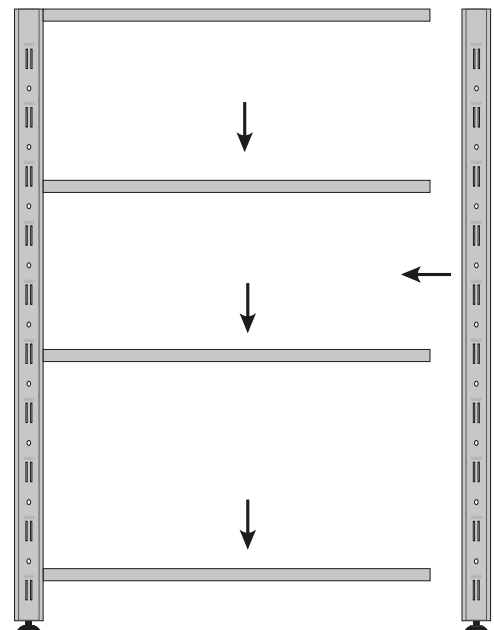
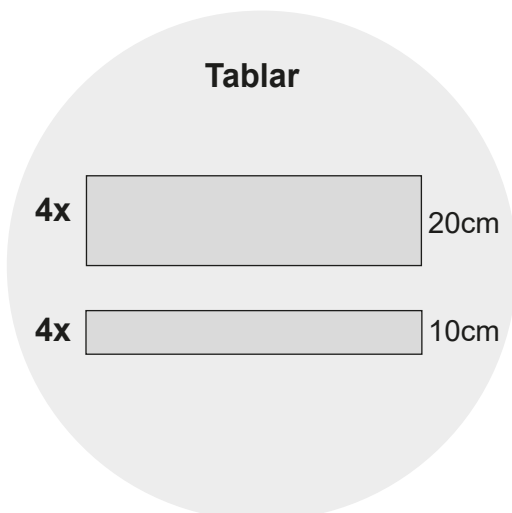

7

Längsstabilisierung mit 4 schrauben montieren

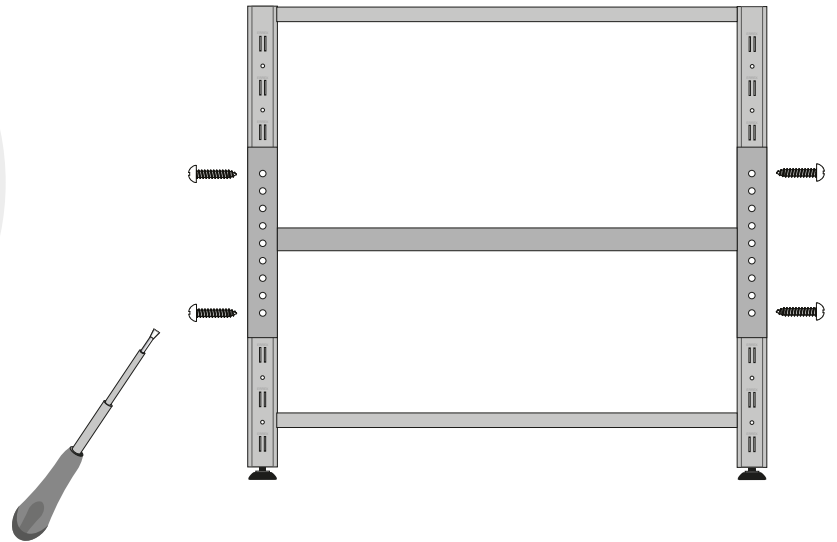
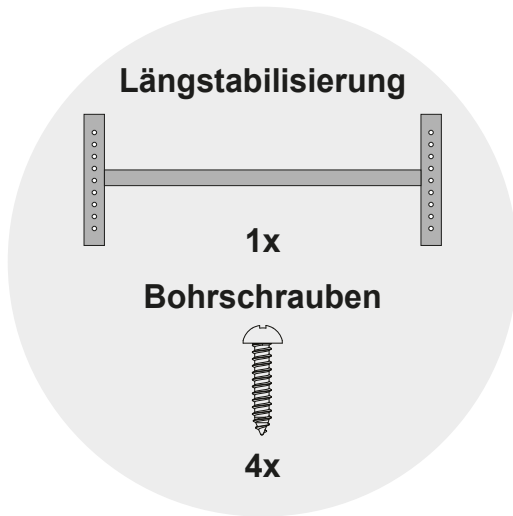

8

Pfeilerabdeckung aufstecken

