



Features:

- 3G, GPRS, GSM
 - 824-960, 1710-2170MHz
- GNSS
 - GPS, Galileo Glonass, Beidou
 - 1560-1608MHz
 - 30dB LNA
- Magnetic mount onto metal surfaces
- IP67

Applications:

- Vehicular use
- Fleet management
- Tracking, navigation
- For easy installation and removal, no need to drill any holes

All dimensions are in mm / inches

Issue: 1719

In the effort to improve our products, we reserve the right to make changes judged to be necessary.

CONFIDENTIAL AND PROPRIETARY INFORMATION

This document contains confidential and proprietary information of Pulse Electronics, Inc. (Pulse) and is protected by copyright, trade secret and other state and federal laws. Its receipt or possession does not convey any rights to reproduce, disclose its contents, or to manufacture, use or sell anything it may describe. Reproduction, disclosure or use without specific written authorization of Pulse is strictly forbidden.

For more information:

Pulse Worldwide Headquarters
15255 Innovation Drive #100
San Diego, CA 92128
USA
Tel: 1-858-674-8100

Pulse/Larsen Antennas
18110 SE 34th St Bldg 2 Suite 250
Vancouver, WA 98683
USA
Tel: 1-360-944-7551

Europe Headquarters
Pulse GmbH & Do, KG
Zeppelinstrasse 15
Herrenberg, Germany
Tel: 49 7032 7806 0

Pulse (Suzhou) Wireless Products Co, Inc.
99 Huo Ju Road(#29 Bldg,4th Phase
Suzhou New District
Jiangsu Province, Suzhou 215009 PR China
Tel: 86 512 6807 9998

Description: 3G/GPRS/GSM + GNSS IP67 with Magnetic Mount

Series: Outdoor Multi Band

PART NUMBER: W4165MMXX

This document covers all product variants of the following product family

| Antennas | GSM Cable | | | GPS Cable | | |
|----------------|-----------------|---------------------|-------------|-----------------|---------------------|-------------|
| | Cable Type | Cable Length | Connector | Cable Type | Cable Length | Connector |
| W4165MM | RG-174 Black | 4000mm/157.5"/13.2' | SMA Male | RG-174 Black | 4000mm/157.5"/13.2' | SMA Male |
| W4165MMAI | | 1524mm/60"/5' | TNC Male | | 1524mm/60"/5' | RP-TNC Male |
| W4165MMSMA5 | | 1524mm/60"/5' | SMA Male | | 1524mm/60"/5' | SMA Male |
| W4165MMRPSMA10 | | 3048mm/120"/10' | RP-SMA Male | | 3048mm/120"/10' | RP-SMA Male |

Issue: 1719

In the effort to improve our products, we reserve the right to make changes judged to be necessary.

CONFIDENTIAL AND PROPRIETARY INFORMATION

This document contains confidential and proprietary information of Pulse Electronics, Inc. (Pulse) and is protected by copyright, trade secret and other state and federal laws. Its receipt or possession does not convey any rights to reproduce, disclose its contents, or to manufacture, use or sell anything it may describe. Reproduction, disclosure or use without specific written authorization of Pulse is strictly forbidden.

For more information:

Pulse Worldwide Headquarters
15255 Innovation Drive #100
San Diego, CA 92128
USA
Tel: 1-858-674-8100

Pulse/Larsen Antennas
18110 SE 34th St Bldg 2 Suite 250
Vancouver, WA 98683
USA
Tel: 1-360-944-7551

Europe Headquarters
Pulse GmbH & Do, KG
Zeppelinstrasse 15
Herrenberg, Germany
Tel: 49 7032 7806 0

Pulse (Suzhou) Wireless Products Co, Inc.
99 Huo Ju Road(#29 Bldg,4th Phase
Suzhou New District
Jiangsu Province, Suzhou 215009 PR China
Tel: 86 512 6807 9998



Description: 3G/GPRS/GSM + GNSS IP67 with Magnetic Mount

PART NUMBER: W4165MMXX

Series: Outdoor Multi Band

ELECTRICAL SPECIFICATIONS

| | | |
|--|---|-------|
| Frequency (GSM) | 824-960/1710-2170 MHz | |
| Frequency (Beidou,GPS,Galileo,Glonass) | 1561.098±2.046/ 1575.42±1.023/ 1602.5625±4MHz | |
| Nominal Impedance | 50 Ω | |
| VSWR** (GSM) | < 2:1 | |
| Average Peak Gain* (GSM antenna, Low band, typical) | 4 dB | |
| Average Peak Gain* (GSM antenna, High band, typical) | 4.5 dB | |
| GNSS antenna RHCP gain | 1 dBic ± 2 dB | |
| LNA gain | 30 dB ± 2 dB | |
| Noise Figure | 2.5 (cascade) dB | |
| Current | 9 mA ± 2 mA | |
| Vdc | 3-5Vdc | |
| LNA and filter attenuation | | |
| | @ 824 MHz | 70 dB |
| | @960 MHz | 65 dB |
| | @1710 MHz | 60 dB |
| | @2170 MHz | 65 dB |

*Measured on diameter 500mm GND plane and with 5 inch cables

** Measured on diameter 500mm GND plane and with 10 feet cables

Description: 3G/GPRS/GSM + GNSS IP67 with
Magnetic Mount

PART NUMBER: W4165MMXX

Series: Outdoor Multi Band

MECHANICAL SPECIFICATIONS

| | |
|------------------------------------|---|
| Antenna Color / Material | Black |
| Connector type | As requested |
| Cable type | RG-174, Black |
| Cable length | As requested |
| Fixing system | Magnetic mount |
| Pull Force (in Z direction) | min. 100N (22.5 lbf) |
| Side Push Forth (in X/Y direction) | min. 140N (30 lbf) |
| Connector retention | 30 N |
| Strain relief | 30 N, applied to cable along axis and perpendicular to cable entry |

ENVIRONMENTAL SPECIFICATIONS

| | |
|-----------------------|-------------|
| Operating Temperature | -40 ~ 85° C |
| Storage Temperature | -40 ~ 85° C |
| Ingress Protection | IP67 |
| Wind-loading | 160 km/h |
| RoHS Compliant | Yes |

Description: 3G/GPRS/GSM + GNSS IP67 with
Magnetic Mount

Series: Outdoor Multi Band

PART NUMBER: W4165MMXX

MECHANICAL DRAWING

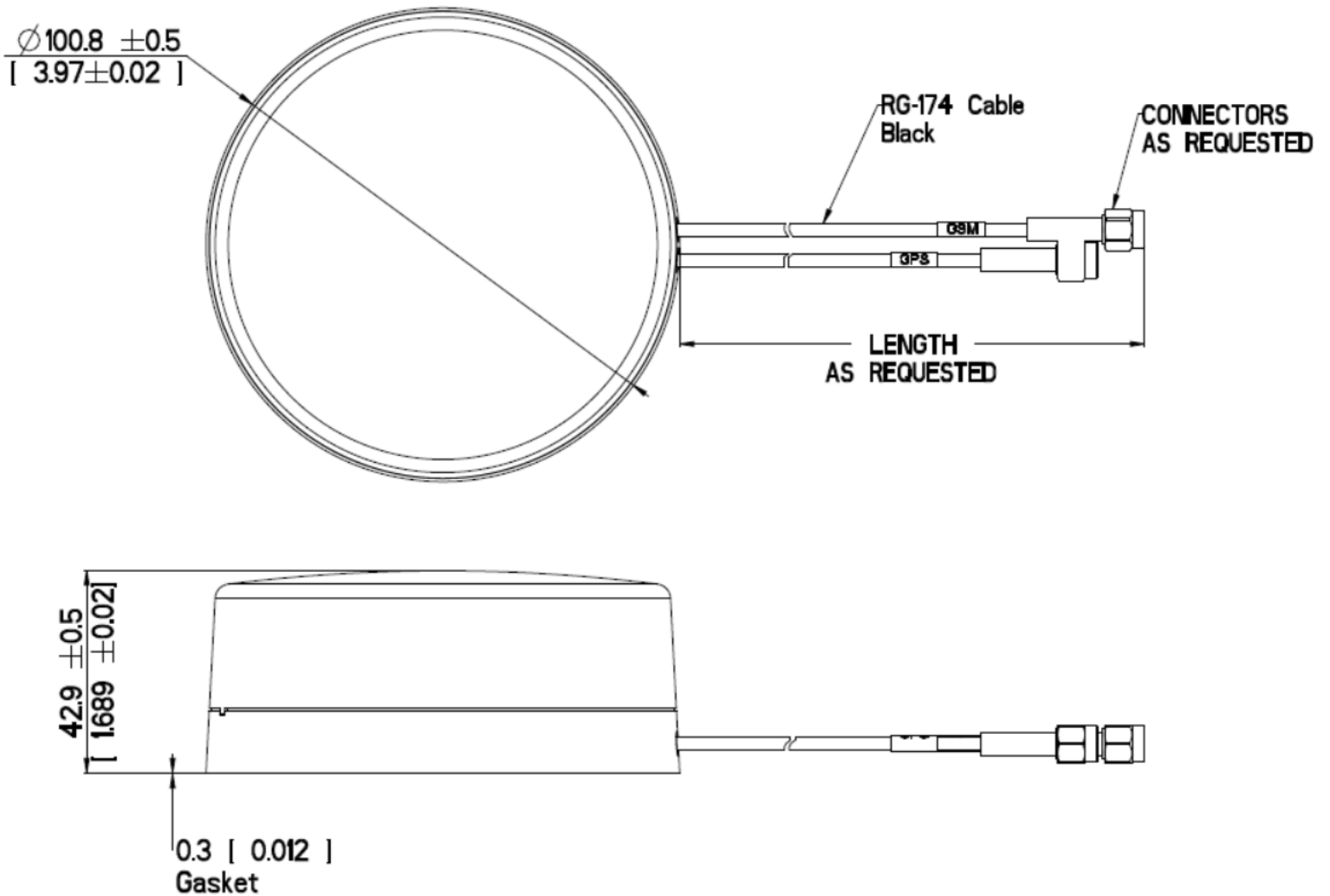

Issue: 1719

In the effort to improve our products, we reserve the right to make changes judged to be necessary.

CONFIDENTIAL AND PROPRIETARY INFORMATION

This document contains confidential and proprietary information of Pulse Electronics, Inc. (Pulse) and is protected by copyright, trade secret and other state and federal laws. Its receipt or possession does not convey any rights to reproduce, disclose its contents, or to manufacture, use or sell anything it may describe. Reproduction, disclosure or use without specific written authorization of Pulse is strictly forbidden.

Description: 3G/GPRS/GSM + GNSS IP67 with
Magnetic Mount

PART NUMBER: W4165MMXX

Series: Outdoor Multi Band

TEST SETUP

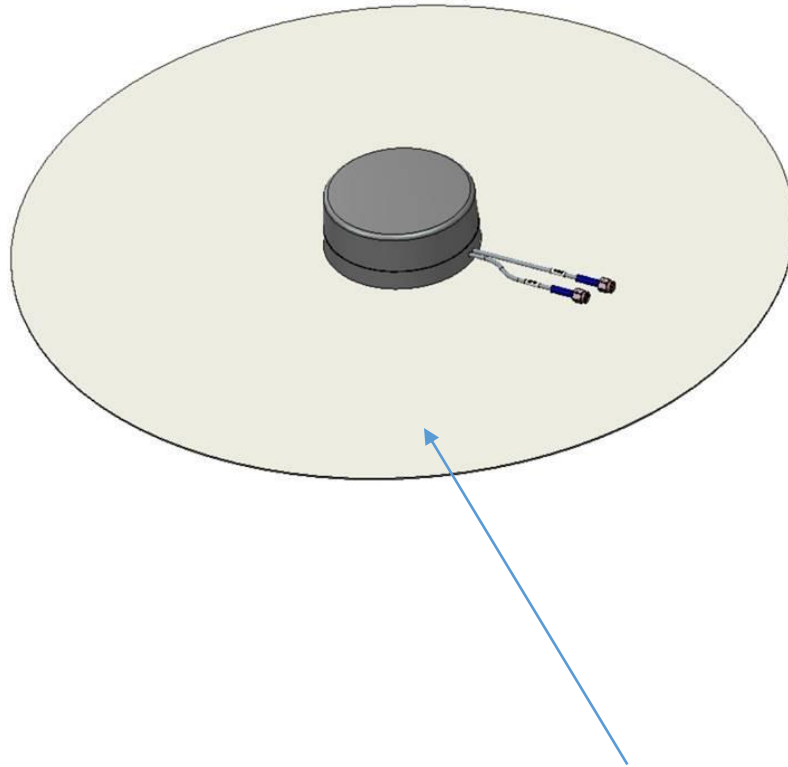

Diameter: 500mm ground pane

*Measured on diameter 500mm GND plane and with 5 inch cables for radiation performance

** Measured on diameter 500mm GND plane and with 10 feet cables for VSWR

Issue: 1719

In the effort to improve our products, we reserve the right to make changes judged to be necessary.

CONFIDENTIAL AND PROPRIETARY INFORMATION

This document contains confidential and proprietary information of Pulse Electronics, Inc. (Pulse) and is protected by copyright, trade secret and other state and federal laws. Its receipt or possession does not convey any rights to reproduce, disclose its contents, or to manufacture, use or sell anything it may describe. Reproduction, disclosure or use without specific written authorization of Pulse is strictly forbidden.

Description: 3G/GPRS/GSM + GNSS IP67 with
Magnetic Mount

PART NUMBER: W4165MMXX

Series: Outdoor Multi Band

CHARTS

VSWR*

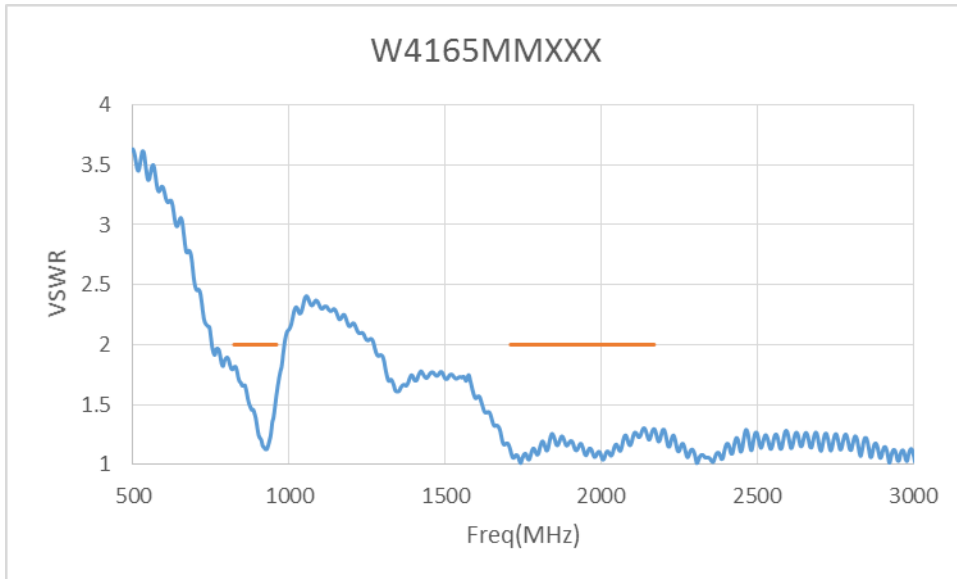

GNSS LNA performance

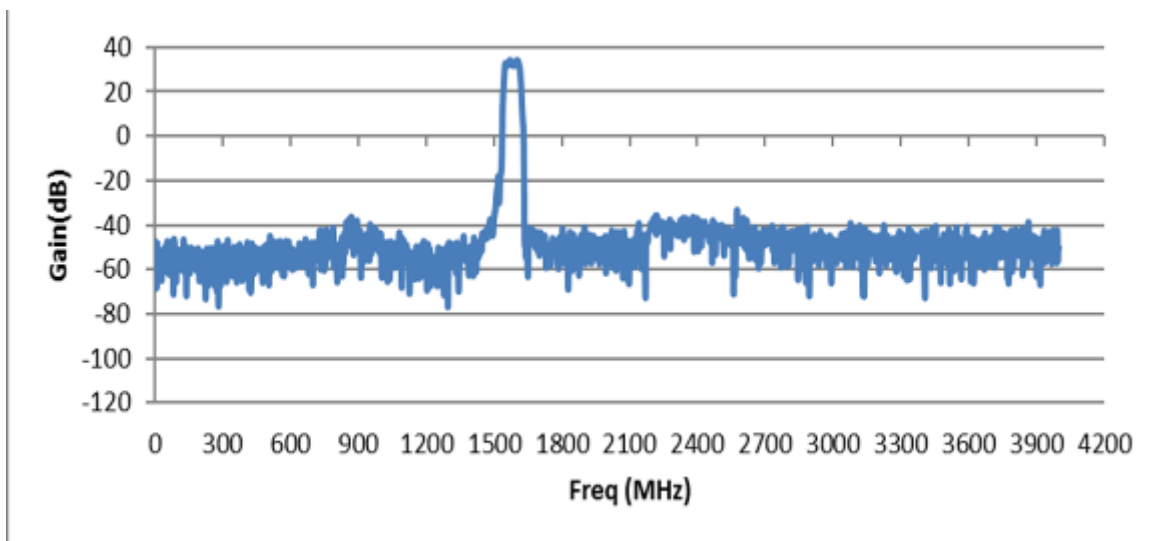

Issue: 1719

In the effort to improve our products, we reserve the right to make changes judged to be necessary.

CONFIDENTIAL AND PROPRIETARY INFORMATION

This document contains confidential and proprietary information of Pulse Electronics, Inc. (Pulse) and is protected by copyright, trade secret and other state and federal laws. Its receipt or possession does not convey any rights to reproduce, disclose its contents, or to manufacture, use or sell anything it may describe. Reproduction, disclosure or use without specific written authorization of Pulse is strictly forbidden.

Description: 3G/GPRS/GSM + GNSS IP67 with
Magnetic Mount

PART NUMBER: W4165MMXX

Series: Outdoor Multi Band

CHARTS

GSM antenna total efficiency*

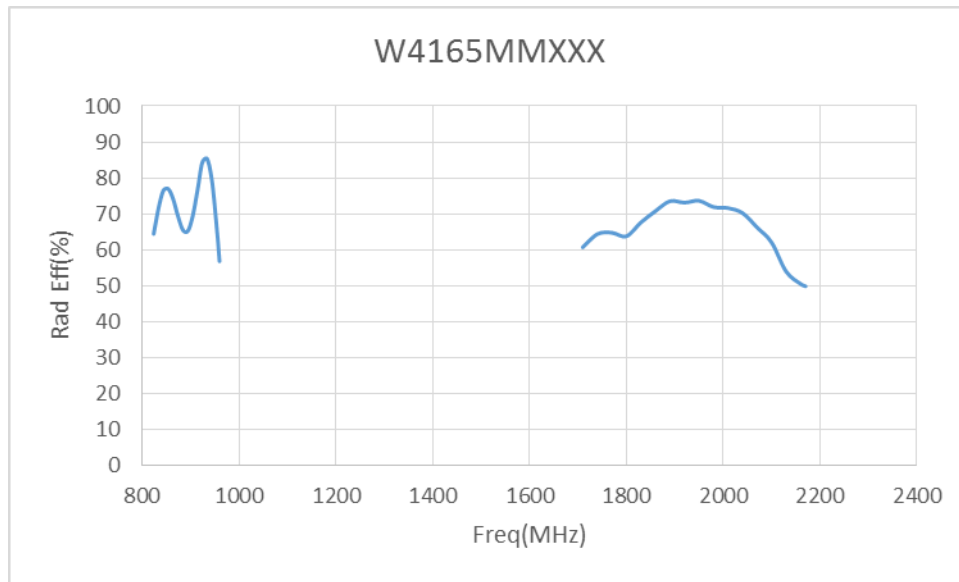

Maximum 3D gain, GSM antenna*

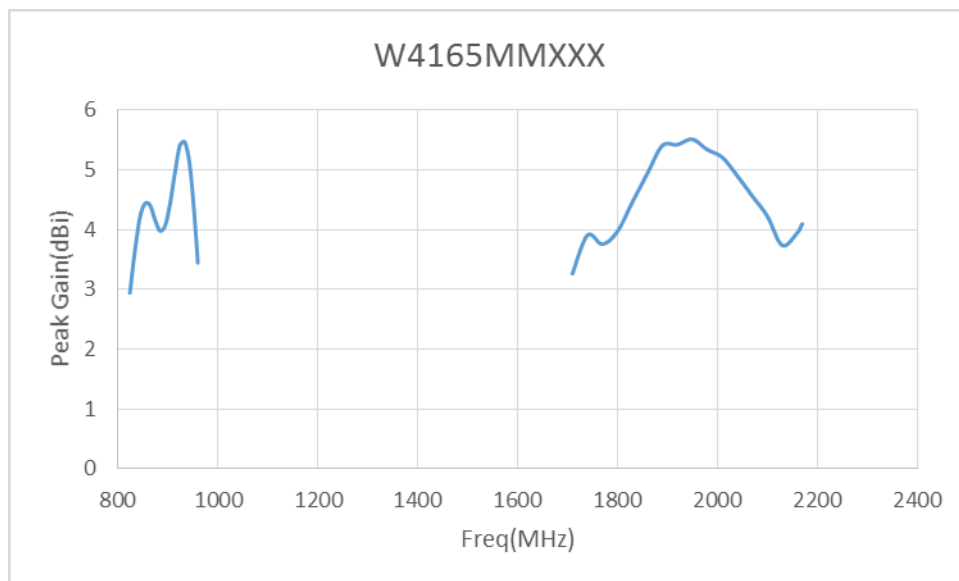

Issue: 1719

In the effort to improve our products, we reserve the right to make changes judged to be necessary.

CONFIDENTIAL AND PROPRIETARY INFORMATION

This document contains confidential and proprietary information of Pulse Electronics, Inc. (Pulse) and is protected by copyright, trade secret and other state and federal laws. Its receipt or possession does not convey any rights to reproduce, disclose its contents, or to manufacture, use or sell anything it may describe. Reproduction, disclosure or use without specific written authorization of Pulse is strictly forbidden.

Description: 3G/GPRS/GSM + GNSS IP67 with Magnetic Mount

PART NUMBER: W4165MMXX

Series: Outdoor Multi Band

CHARTS

GSM antenna Low band Radiation Pattern X-Y Plane*

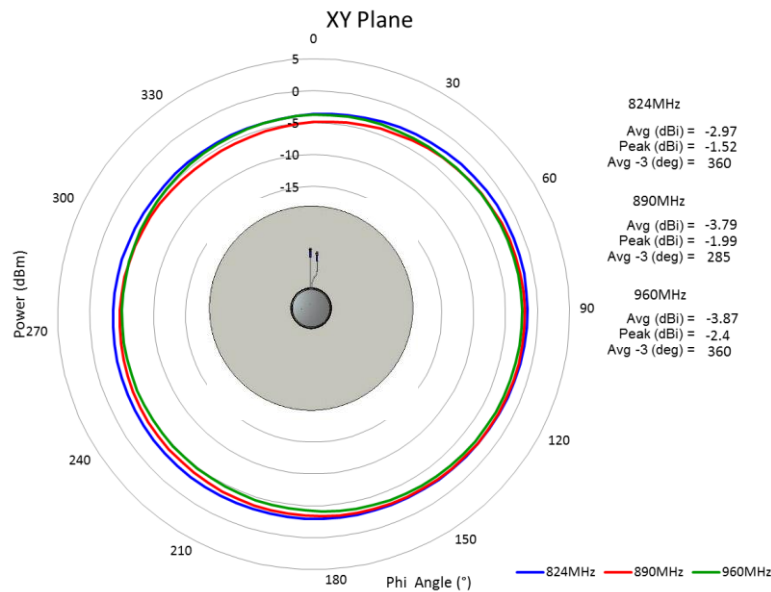

GSM antenna Low band Radiation Pattern Z-X Plane*

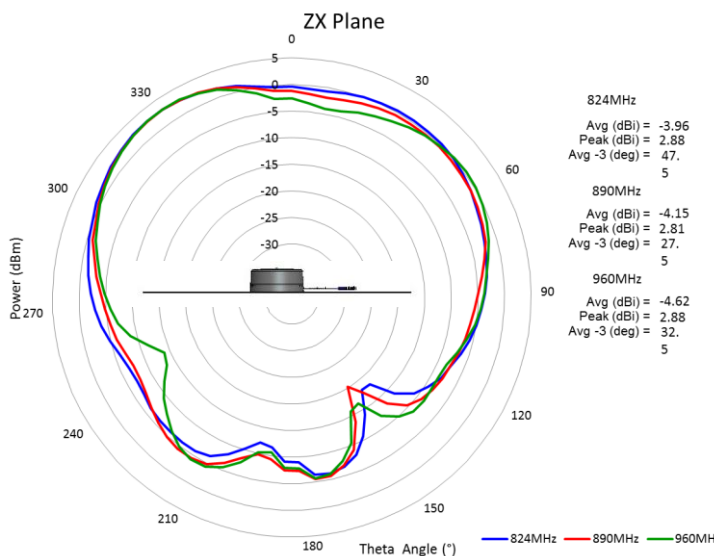

Issue: 1719

In the effort to improve our products, we reserve the right to make changes judged to be necessary.

CONFIDENTIAL AND PROPRIETARY INFORMATION

This document contains confidential and proprietary information of Pulse Electronics, Inc. (Pulse) and is protected by copyright, trade secret and other state and federal laws. Its receipt or possession does not convey any rights to reproduce, disclose its contents, or to manufacture, use or sell anything it may describe. Reproduction, disclosure or use without specific written authorization of Pulse is strictly forbidden.

Description: 3G/GPRS/GSM + GNSS IP67 with Magnetic Mount

PART NUMBER: W4165MMXX

Series: Outdoor Multi Band

CHARTS

GSM antenna Low band Radiation Pattern Y-Z Plane*

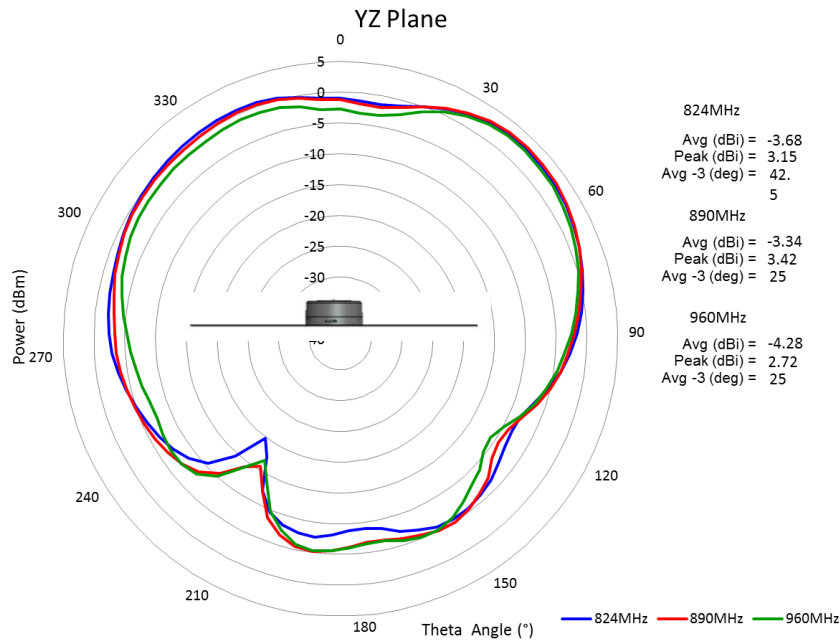

GSM antenna High band Radiation Pattern X-Y Plane*

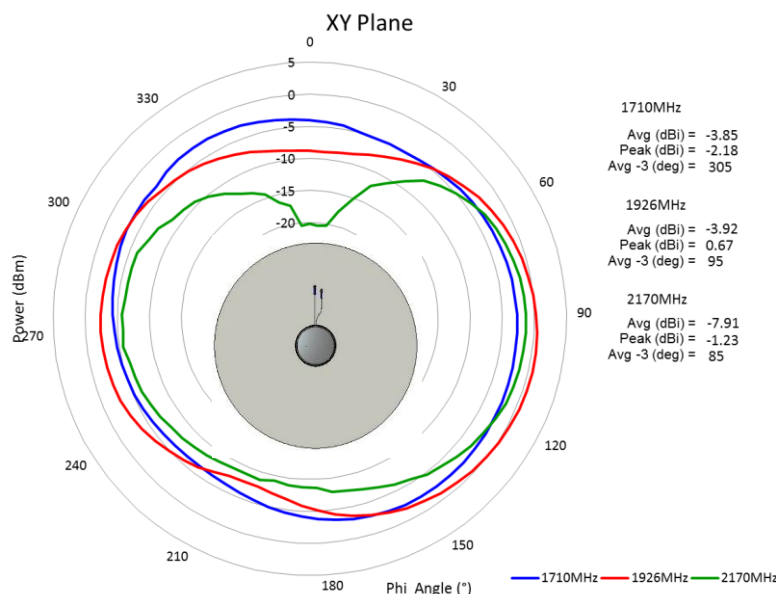

Issue: 1719

In the effort to improve our products, we reserve the right to make changes judged to be necessary.

CONFIDENTIAL AND PROPRIETARY INFORMATION

This document contains confidential and proprietary information of Pulse Electronics, Inc. (Pulse) and is protected by copyright, trade secret and other state and federal laws. Its receipt or possession does not convey any rights to reproduce, disclose its contents, or to manufacture, use or sell anything it may describe. Reproduction, disclosure or use without specific written authorization of Pulse is strictly forbidden.

Description: 3G/GPRS/GSM + GNSS IP67 with Magnetic Mount

Series: Outdoor Multi Band

PART NUMBER: W4165MMXX

CHARTS

GSM antenna High band Radiation Pattern Z-X Plane*

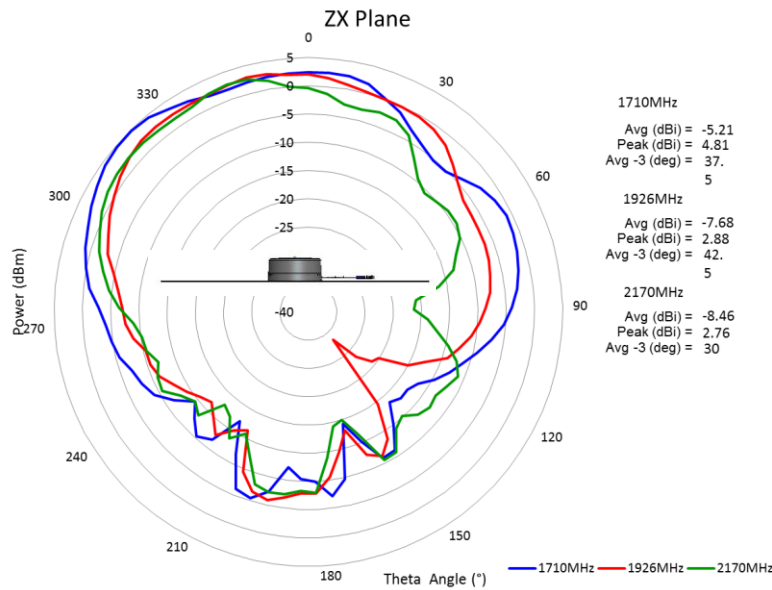

GSM antenna High band Radiation Pattern Y-Z Plane*

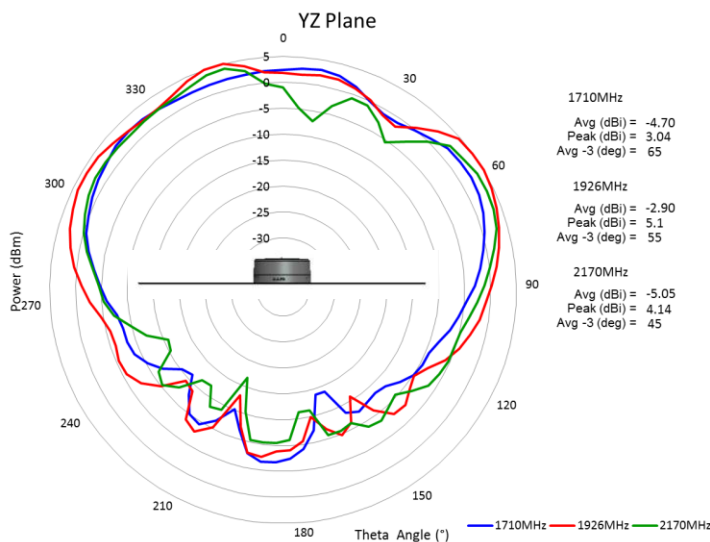

Issue: 1719

In the effort to improve our products, we reserve the right to make changes judged to be necessary.

CONFIDENTIAL AND PROPRIETARY INFORMATION

This document contains confidential and proprietary information of Pulse Electronics, Inc. (Pulse) and is protected by copyright, trade secret and other state and federal laws. Its receipt or possession does not convey any rights to reproduce, disclose its contents, or to manufacture, use or sell anything it may describe. Reproduction, disclosure or use without specific written authorization of Pulse is strictly forbidden.

Description: 3G/GPRS/GSM + GNSS IP67 with
Magnetic Mount

PART NUMBER: W4165MMXX

Series: Outdoor Multi Band

CHARTS

RHCP Radiation Pattern (70mm x 70mm ground plane) GPS & Galileo

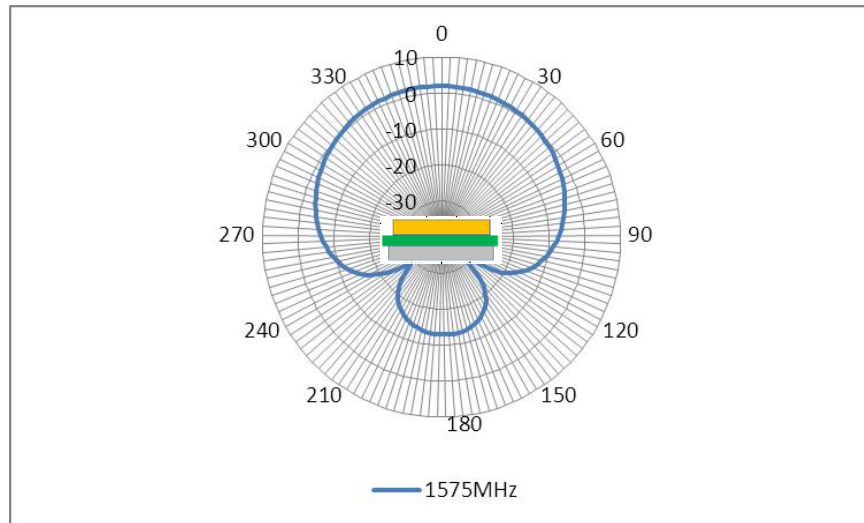

RHCP Radiation Pattern (70mm x 70mm ground plane) GLONASS

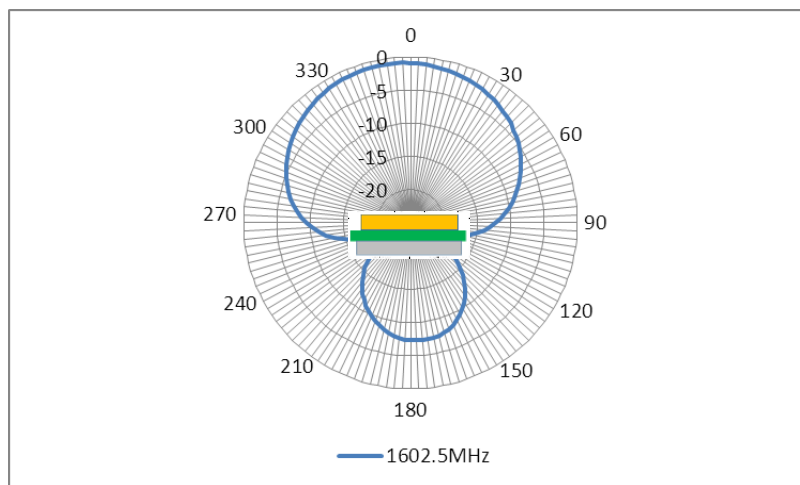

Description: 3G/GPRS/GSM + GNSS IP67 with
Magnetic Mount

PART NUMBER: W4165MMXX

Series: Outdoor Multi Band

CHARTS

RHCP Radiation Pattern (70mm x 70mm ground plane) BD2

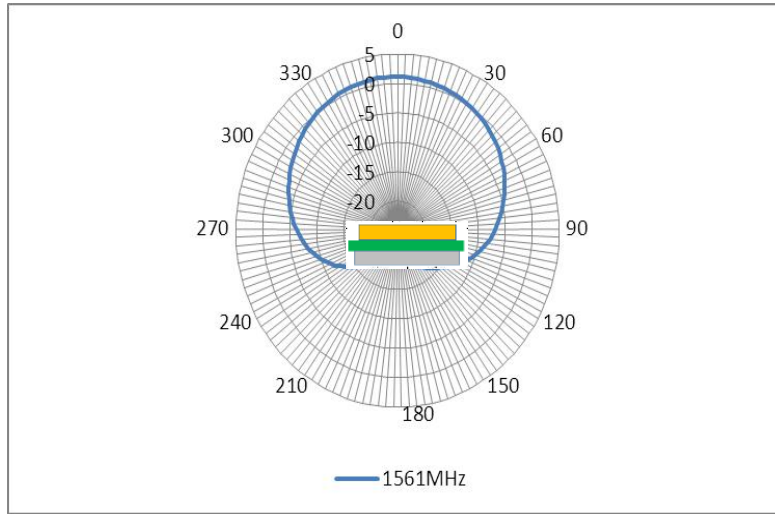

Issue: 1719

In the effort to improve our products, we reserve the right to make changes judged to be necessary.

CONFIDENTIAL AND PROPRIETARY INFORMATION

This document contains confidential and proprietary information of Pulse Electronics, Inc. (Pulse) and is protected by copyright, trade secret and other state and federal laws. Its receipt or possession does not convey any rights to reproduce, disclose its contents, or to manufacture, use or sell anything it may describe. Reproduction, disclosure or use without specific written authorization of Pulse is strictly forbidden.

Description: 3G/GPRS/GSM + GNSS IP67 with
Magnetic Mount

PART NUMBER: W4165MMXX

Series: Outdoor Multi Band

PACKAGING

1 antenna packed in a plastic bag

12 plastic bags of antennas packed in a carton

1 label on each carton with part number, description, date code.

Mouser Electronics

Authorized Distributor

Click to View Pricing, Inventory, Delivery & Lifecycle Information:

Pulse:

[W4165MMSMA5](#) [W4165MM](#) [W4165MMRPSMA10](#)