



AMP™

(Adaptive Mission Platform)

Communication Headset

Operator's Manual

OM101153-00

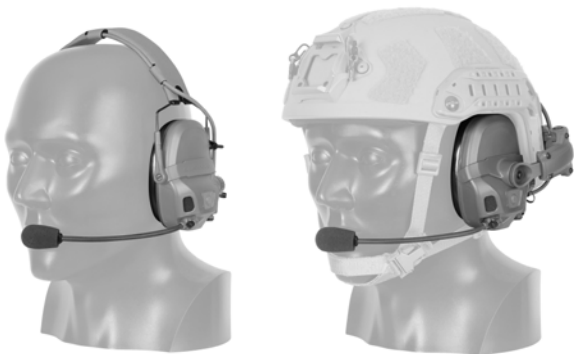

REV. 20210304

This product is covered by one or more patents.
For more information visit www.gentexcorp.com/patents

www.ops-core.com

TABLE OF CONTENTS

Introduction	3
Product Highlights / Key Features	4
Product Overview	6
Preparing the AMP Communication Headset for Use	8
Installing/Replacing Batteries	9
Moving Microphone to Opposite Earcup	10
Connecting a Respiratory Protection / Oxygen Mask to the Headset	12
3D Hear-Through (3DHT) Mode	14
Near Field Magnetic Induction (NFI) Earplugs	16
Helmet Rail Mounted Operation	18
Hook and Loop Fastener Installation	19
Headband Removal	20
Rail Arm Installation	22
Helmet Attachment	24
Stowed Position	26
Helmet Donning / Doffing	28
Detaching Rail Arms	30
Removing Earcups from Rail Arms	32
Attaching Earcups to Headband	34
Attaching Headset Downlead	36
Disconnecting Headset Downlead	37
Fixed Downlead Models	38
Maintenance	40
Storage	41
Troubleshooting	42
Customer Service	42
Specifications	43
EU Declaration of Conformity	46
Warning & Warranty	47

INTRODUCTION

About the Ops-Core AMP (Adaptive Mission Platform) Communication Headset

The advanced hear-through and hearing protection capabilities in the Ops-Core AMP Communication Headset enhance situational awareness and user safety. For optimal flexibility and performance, the modular headset can be easily configured to meet a wide range of mission needs with options for headband or helmet mounted use, single or double hearing protection (NFMI models only), and single or multi-channel communications.



PRODUCT HIGHLIGHTS / KEY FEATURES

■ **World Class Audio Quality**

Leveraging industry leading capabilities of the military, industrial safety hearing protection, and communication systems of parent company Gentex Corporation, the Ops-Core AMP Communication Headset provides unprecedented audio quality with ability to operate in combat environments.

■ **3D Hear-Through (3DHT)**

Restores and enhances “natural hearing” of outside environment for improved situational awareness. Ear-simulator design reproduces ambient sounds with a high degree of directional accuracy, while also providing robust hearing protection.

■ **Optional NFMI (Near Field Magnetic Induction) Earplugs (sold separately)**

Provide increased noise reduction, while maintaining clear communications and 3D Hear-Through. NFMI Earplugs do not require wires or batteries. NOTE: Compatible with NFMI headsets only.

■ **Mission Configurable Capability**

Dual configuration capability adapts headset to either headband or helmet mounted preference based on operational requirements.

• **Ergonomic Headband**

Headband construction is of metal wire frame covered in Nylon 70 fabric, engineered for optimal comfort and streamlined profile, capable of being worn under a helmet. Quick attach/detach from headband capability.

• **Rail Mount Kit (sold separately)**

Optional rail arms manufactured from PBT + PC blend can be mounted to rear of ARC rails, leaving top portion of rails free for other accessories, while increasing helmet stabilization and a counterbalancing effect of shroud mounted devices. Single point gimbal attachment to earcups allows for 360° adjustment, providing a better earseal and accommodation of head movement. Rotate earcups to side or rear of helmet to create low profile, streamlined stowage when not in use.

- **Quick-Release Download Connections (Connectorized Models Only)**

Disconnect headset from download(s) to allow for set up on left, right or both sides. System can quickly configure between single, dual, or no download.

- **Noise Canceling Microphone**

Mitigates background noise enabling clear communication. Can be mounted to left or right earcup or removed as preferred.

- **Integrated Microphone Mounting & Connection Point**

Enables easy integration with any U-173/U standard plug.

- **Earseals**

Ergonomic ear seals made of foam with Polyether Polyurethane covering have been designed to provide comfort, while maintaining excellent noise reduction performance.

- **Auto Shut-Down**

To preserve battery life, alert tones signal 3DHT shut down after two hours of inactivity. Pressing volume button resets timer. Included AAA lithium batteries provide up to 120 hours of 3DHT use.

- **Fail-Safe Communications**

In the event of battery loss, 3DHT will power off leaving headset and earplugs to operate for standard communication.

- **CE Certified**

This product has been assessed against the requirements of the following standards for hearing protection:

EN352-1:2002 Hearing Protectors – General Requirements – Part 1 : Ear Muffs

EN352-3:2002 Hearing Protectors – General Requirements – Part 3 : Ear Muffs attached to an Industrial Safety Helmet

These headsets are to be used with the headband supplied, approved mounting accessory, or fitted to the Gentex / Ops-Core helmet.

PRODUCT OVERVIEW

LEFT EARCUP



RIGHT EARCUP



Download Connector
(Connectorized Models Only)



PREPARING THE HEADSET FOR USE

The Wearer Should Ensure That:

- A.** The headsets are fitted, adjusted, and maintained in accordance with the manufacturer's instructions
- B.** The headsets are worn at all times in noisy surroundings
- C.** The headsets are regularly inspected for serviceability. Cushions may deteriorate with use and should be examined at frequent intervals for cracking
- D.** The headsets are cleaned regularly in accordance with the manufacturer's instructions.
- E.** The headsets are stored in accordance with the manufacturer's instructions.

Warning:

- A.** If the recommendations given above are not adhered to, the protection afforded by the headsets will be severely impaired.
- B.** The fitting of hygiene covers to the cushions may affect the acoustic performance of the headset.
- C.** This product may be adversely affected by certain chemical substances. Further information should be sought from the manufacturer.

Installing/Replacing Batteries

1. Unscrew battery tube cap
2. Insert the battery into the battery tube with positive (+) end facing outwards
3. Reinstall battery tube cap and ensure that it is tight
4. Repeat steps on other earcup.

NOTE: For optimal performance, always use lithium batteries and always replace as a set in both earcups. Remove batteries when headset is not in use for longer durations.



Moving Microphone to Opposite Earcup (Optional)

1. Loosen the thumb screw that attaches the microphone to the earcup.

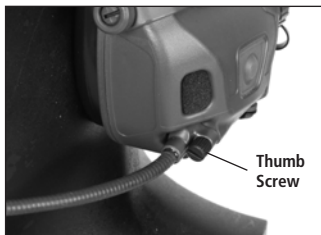

2. Unplug the microphone by grabbing the flex boom and pulling it straight away from the earcup.

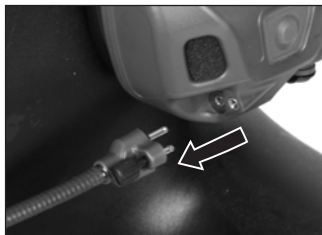

3. Remove the mic port plug on the opposite earcup.



-
4. Plug the microphone into the opposite earcup and tighten the thumbscrew by hand. If desired, you may use a flathead driver to tighten 1/8 turn beyond finger tight (12 inch-ounces).

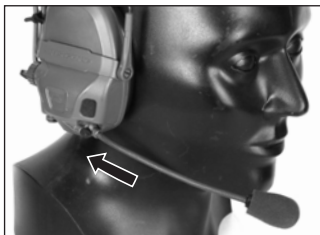

5. Install the mic port plug onto the earcup from which you removed the microphone.

NOTE: If you desire to configure the headset without a boom mic for listen only / hear-through only operation, skip steps 3 and 4.

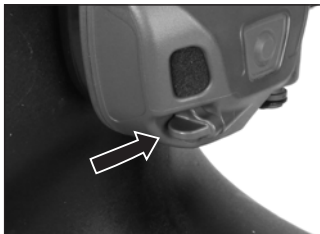

Connecting a Respiratory Protection / Oxygen Mask to the Headset (Optional)

The headset has two microphone ports that can be used with the boom microphone, a respiratory protector / oxygen mask, or both simultaneously. To connect a respiratory protector / oxygen mask:

1. Plug the adapter cable into the mask.
2. Plug the other end into an open microphone port on the headset.

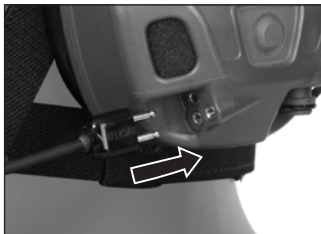

NOTE: If you have both the boom microphone and mask mic connected to the headset, both will be active at the same time. Depending on your environment and operational need, disconnect the boom microphone and stow if you need it to be inactive.



3D HEAR-THROUGH (3DHT) MODE

Operating the 3D Hear-Through (3DHT) Mode

The 3D Hear-Through mode reproduces ambient sounds from the environment through the earcups for increased situational awareness. The radio / intercom communications function continues with hear-through turned on or off.

To turn Hear-Through ON: Press and hold any volume button. The headset emits three ascending tones, and the hear-through function activates.

To increase Hear-Through volume: Press or hold the forward volume + button. The headset emits a short tone that gets louder as the volume increases.

To decrease Hear-Through volume: Press or hold the rear volume – button. The headset emits a long tone that gets softer as the volume decreases. At the lowest volume position, hear-through function will mute.

To turn Hear-Through OFF: Press and hold the volume + and – button together. The headset emits three descending tones, and the hear-through function ceases.

Hibernation Mode Alerts	
Hibernate Warning	If no volume presses in 2 hours, you will get a hibernation warning every 15 seconds for 1 minute (to reset time duration press a volume button).
Hibernation Mode	After 2 hours of hear-through use with no volume presses, hear through will power off. To power hear-through back on, press and hold any volume button.

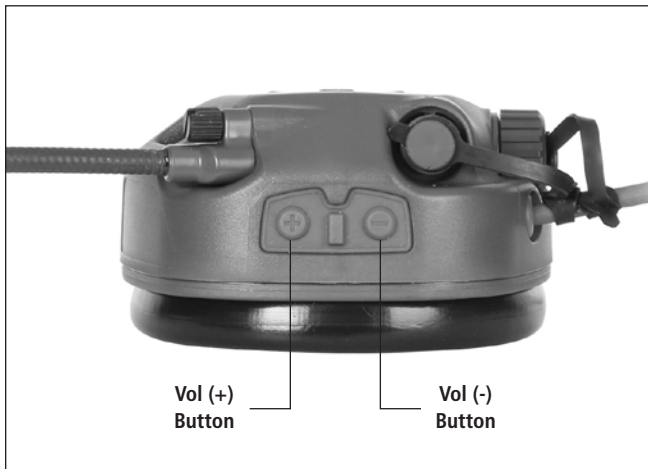

Low Battery Warning Alerts (with lithium batteries)	
Initial Low Battery Alert	50 mins (approx.) of remaining use. Indicated by 4 tones.
Very Low Battery Alert	20 mins (approx.) of remaining use. Indicated by 3 groups of 4 tones at higher amplitude.
Shut Down	0 mins of remaining use. The headset hear-through will power off. Radio communication will continue to function.

NFMI EARPLUGS

Using NFMI Earplugs (sold separately)

1. Select the standard tips to start and remove the foam tips from the packaging. Foam tip sizes are Slim, Standard, and Large (in case of fitting problems, try the next smaller or larger size, as needed).



2. Thread foam tips onto the earplugs. Ensure that the foam tip is fully threaded onto the earplug.



3. Roll the foam tip between your fingers to compress it.



-
- Carefully insert the foam tip into the ear, ensuring the earplug is level in the ear as shown.
 - Repeat Steps 3 and 4 to insert the other earplug into other ear.
 - Don headband / helmet; adjust and connect the headset.
 - Press the NFMI button on the left earcup to transfer the audio from the earphone to the NFMI earplug. A double tone is emitted for confirmation.



NFMI Button

NOTE: If you engage the NFMI button without the earplugs in, you will receive no audio.

HELMET RAIL MOUNTED OPERATION

Helmet Rail Mount Kit (sold separately)

Use the following components to mount the headset to the helmet:

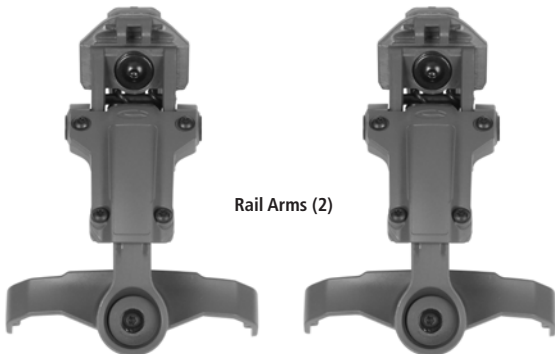

Rail Arms (2)

Loop Fastener Triangles (2)

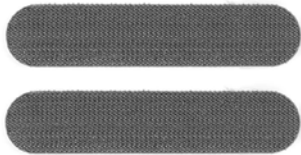
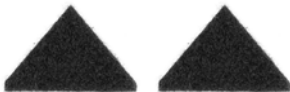

Hook Fastener Strips (2)

HOOK & LOOP FASTENER INSTALLATION

Install the loop fastener on the helmet

1. Remove the backer from the adhesive backed loop fastener triangles and install inside the rear lip of helmet as shown.

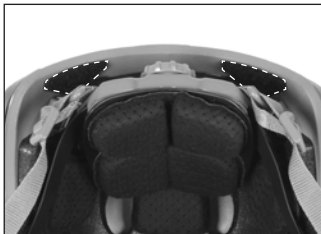

2. Install the two pieces of hook fastener strips as shown.



3. Adjust hook fastener strips position as necessary to properly route the ear-to-ear cable.

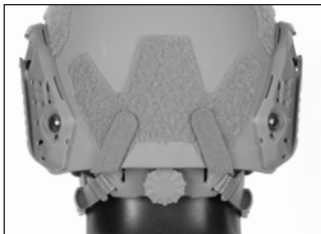

HEADBAND REMOVAL

Removing the Earcups from the Headband

1. Unfasten the three loop fastener cable retention tabs on the headband to free the ear-to-ear cable.



2. Unfasten cable management straps

Cable Management Strap

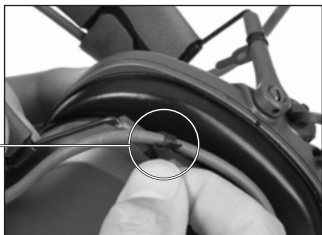

3. Grasp the back of one earcup with one hand.

With your other hand, place your thumb on the headband strap and use your index finger to grab the headband arm where it connects to the headband strap.



-
4. Use your index finger to pull the headband arm towards you, which will free the earcup from the headband.

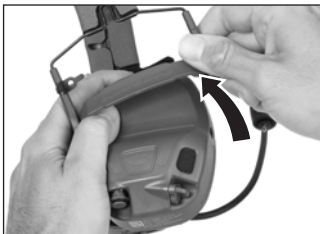

5. Repeat process for the other earcup.



RAIL ARM INSTALLATION

Installing the Headset to the Rail Arms

1. Align the rail arm with the earcup so that the rail arm strap swivel bulge is facing down / arrow marker on the inside of the strap is pointing up.

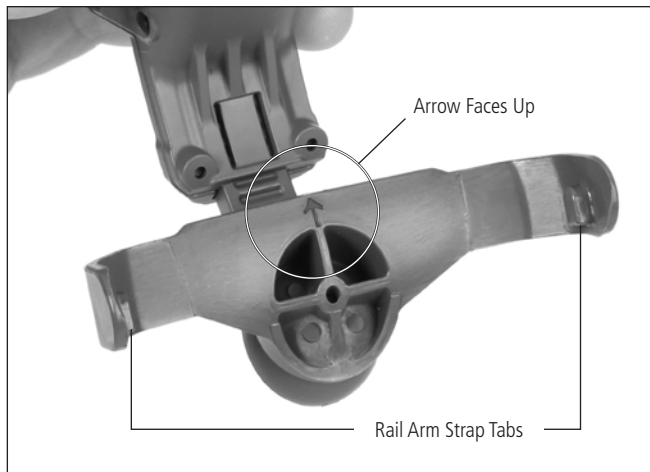

-
2. Insert one side of the rail arm strap tab into the hole on the side of the earcup and push down to snap in the opposite earcup strap tab into the hole on the other side of the earcup. (Repeat for the other earcup).

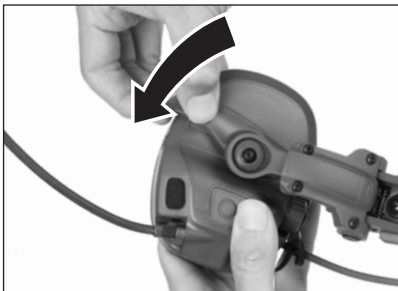

NOTE: DO NOT install the rail arm strap tabs upside-down.

CORRECT



INCORRECT



HELMET ATTACHMENT

Attaching the Headset to the Helmet

1. Rotate the rail arm shoe as shown and insert it into the bottom rear portion of the ARC Rail.



Rail Arm Shoe



2. Push rail arm shoe up until the tab clicks into the desired rail slot.

(Repeat steps 1 and 2 for other earcup)



-
- 3.** Rotate the arm and earcup over the ear position and insert cable into cable clip as shown.

(Repeat for the other earcup).

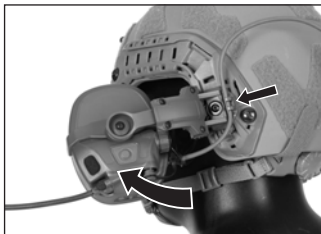

- 4.** Attach cable to helmet as shown using supplied hook and loop fasteners (see pages 16-17).

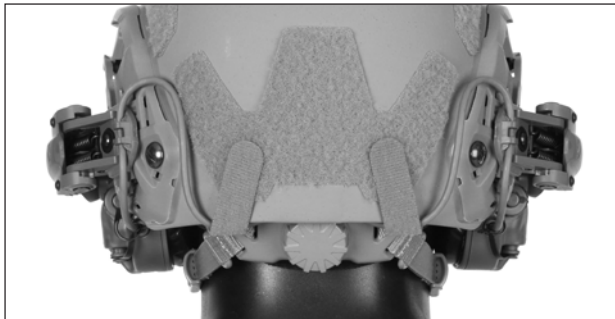

STOWED POSITION

Stowing the Headset on the Helmet

CORRECT



Stow the headset by rotating the earcups UP and over, towards the back of the helmet.



INCORRECT



DO NOT attempt to stow the headset by rotating the earcups DOWN and back. This will cause the cables to bunch up and get twisted.

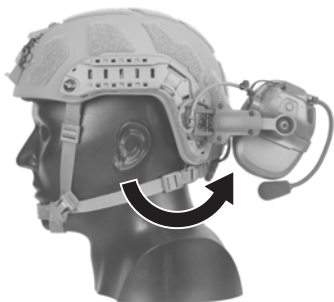

Finish stowing the headset by folding the earcups onto the back of the helmet as shown.



HELMET DONNING / DOFFING

Donning the Helmet and Headset

1. With the headset in the stowed position, don the helmet, fasten the chin strap, and tighten all straps.



2. Pull earcup out; rotate the headset earcups over ears.

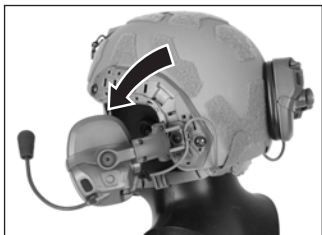

3. Grasp earcup and push towards head and center over ear.

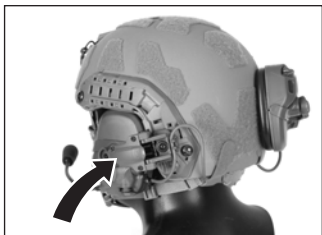

-
4. Adjust the length of the rail arm so that the earcup is centered over the ear and adjust the microphone over the mouth (within ¼ inch) for optimal performance.

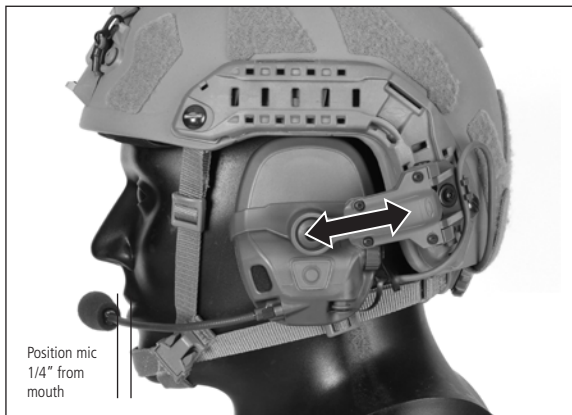

Doffing the Helmet and Headset:

1. Pull earcups away from the head until rail arms remain in open position.
2. Unfasten the chin strap, and remove the helmet.

Optional: before or after removing the helmet, the operator may choose to place the earcups into the stowed position.

DETACHING RAIL MOUNT ARMS

Detaching the Rail Arms from the Helmet

1. Detach the cable from both rail arm cable clips and from the back of the helmet shell by detaching the hook fastener strips.

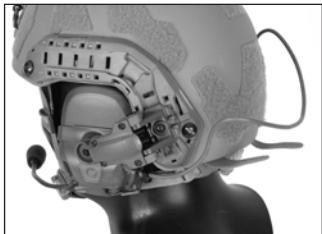

2. Rotate the earcup down as shown.

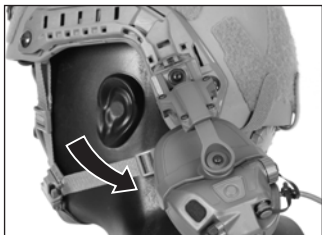

-
- 3.** Lift the tab up and slide the rail arm down and out of the rail.

(Repeat steps 2 and 3 for the other earcup)



Rail Arm Shoe Tab



REMOVING EARCUPS FROM RAIL ARMS

Removing the Earcups from the Rail Arms

1. Remove the ear-to-ear cable from both cable clips (if still connected).

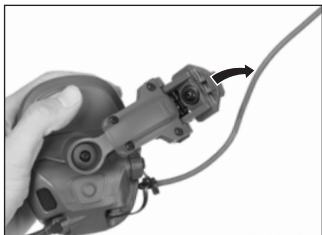

2. Grasp one earcup with one hand.

With your other hand, place your thumb on either the rail arm strap or gimbal point and use your index finger to grab the headband strap at the end tip where it connects to the earcup.

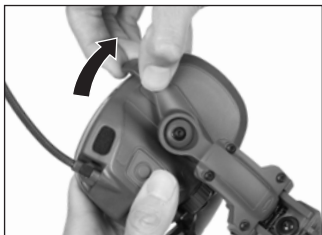

3. Use your index finger to pull the strap towards you, which will free the earcup from the strap.



-
4. Repeat process for the other earcup.



ATTACHING EARCUPS TO HEADBAND

Attaching the Earcups to the Headband

1. Locate arrow on inside of headband attachment arm and ensure that the arrow faces up when attaching to the earcups. The headset arm side with the cable management rubber straps should be at the rear of the headset.

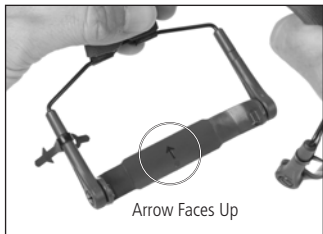

2. Attach headband strap outside of the earcup; snap protruding element into earcup; repeat on other side; earcups now attached to headband.



3. Find / hold center point of ear-to-ear cable. Fold the middle cable retention tab over center point of cable.

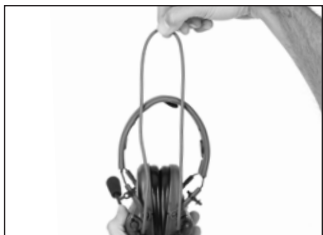

-
- 4.** Locate cable retention tabs on front edge of headband. Secure the cable with the cable retention tabs. Repeat at each end of the headband.

Cable Retention Tabs

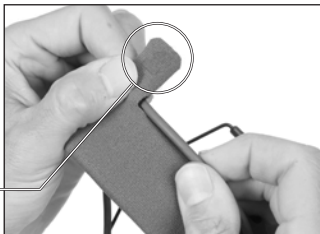

- 5.** Wrap cable management strap around the cable and push tail through loop to secure. Repeat for other earcup. Ensure that the cable is on the outside of the headband attachment arm.



ATTACHING HEADSET DOWNLEAD

(Connectorized Models Only)

Attaching the Headset Downlead (sold separately) to the Headset:

1. Connect the Fischer connector end of the download cable to either the left or the right side of the headset (user's preference). The download cable will have a triangular (▲) marking on the Fischer connector for proper alignment.

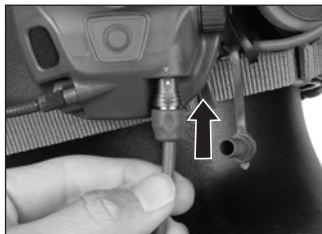
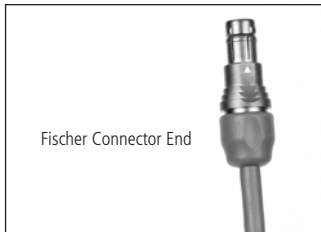

DISCONNECTING HEADSET DOWNLEAD

(Connectorized Models Only)

Disconnecting the Headset Downlead (sold separately) from the Headset:

1. Disconnect the downlead cable from the headset by pulling down on the outer sleeve of the connector to unlock it.

NOTE: DO NOT attempt to disconnect the downlead cable by pulling the cable itself.

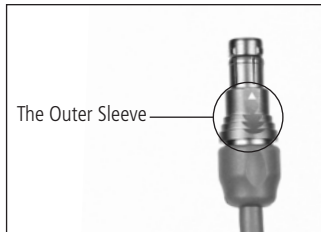

FIXED DOWNLOAD MODELS

The AMP Communication Headset Fixed Download Models feature a permanently attached download cable that is connected to the left earcup.

U174
Fixed Download Model

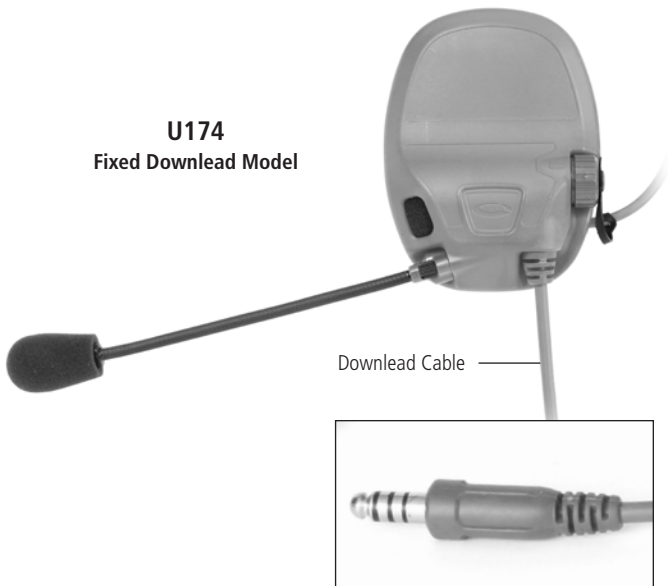

Amphenol
Fixed Download Model

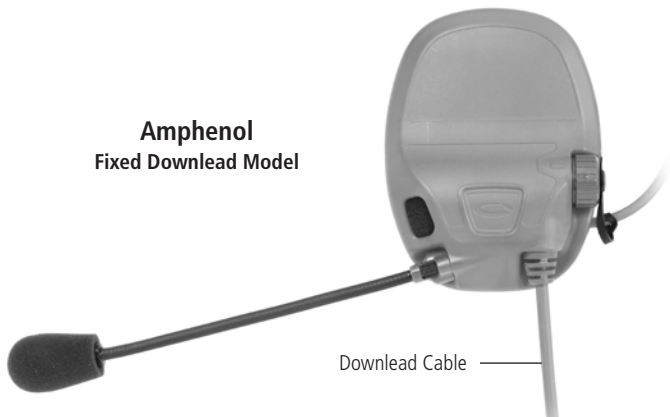

Download Cable



MAINTENANCE

Maintaining Your Headset

Simple maintenance will help keep the headset in good operating condition. Complete the following tasks as necessary.

Inspection

- 1.** Inspect the earseals regularly to ensure that they have no cracks or tears, which can degrade hearing protection and/or cause discomfort. With regular use, it is recommended that you replace your earseals once every six months, or sooner as needed, to maintain maximum protection and comfort.
- 2.** Inspect boom microphone screw regularly and ensure that it is not loose. Do not over-tighten screw.
- 3.** Inspect to ensure that hear-through microphone foam is in place and not protruding.

Cleaning

- 1.** Clean the headset regularly with a soft cloth dampened with soap and water.
- 2.** Dry thoroughly with a clean cloth.

STORAGE

NOTE: When storing the headset, ensure that the earseals are not compressed. Long-term compression can deform the earseals, causing loss of sound attenuation.

1. Remove the batteries before you store the headset for long periods of time.
2. Ensure headset is dry before storing.
3. If possible, store the headset in a cool, dry area. Avoid storing it in areas prone to excessive heat.

TROUBLESHOOTING

Hear-through audio is not activating

1. Assure that the battery caps are tight.
2. Press and hold the + volume button down. If hear-through is off, it will power on. If the volume is set too low, it will ramp up.
3. If you have a NFMI headset, and are not using the NFMI earplugs, try pressing the NFMI toggle button to see if audio returns.
4. Replace the batteries with new ones, and repeat starting at step 1.

CUSTOMER SERVICE

Our dedicated customer service and support professionals are highly trained on all aspects of our products and are available to assist you with all your needs, including orders, billing, warranties and returns, accessory questions, replacement parts, and technical support.

Ops-Core Customer Service

+1 888.894.1755

groundcs@gentexcorp.com

SPECIFICATIONS

Noise Protection Ratings

Headset Alone:	NRR 22 dB SNR 27 dB H 31 dB M 23 dB L 19 dB
NFMI Version (when used with optional NFMI Earplugs):	NRR 34 dB SNR 41 dB H 41 dB M 39 dB L 34 dB
Battery Run Time:	Up to 120 Hours w/ Lithium Batteries @ 21°C
Battery Run Time w/ NFMI engaged:	Up to 80 Hours w/ Lithium Batteries @ 21°C
Salt Water Immersion:	IPX7
Environmental:	MIL-STD-810G
Operating Temperature:	-40°C to +55°C (-40°F to +131°F) with lithium batteries
Storage Temperature:	-40°C to +71°C (-40°F to +160°F)
EMI Testing Standards:	MIL-STD-461G

SPECIFICATIONS

Weight:

AMP Headset Model	Headband Configuration	Rail Mounted Configuration
Connectorized	0.85 lbs (386 g)	0.92 lbs (419g)
Connectorized, NFMI	0.92 lbs (419g)	1.01 lbs (460g)
Fixed Downlead (Amphenol)	0.93 lbs (422g)	1.02 lbs (462g)
Fixed Downlead (Amphenol), NFMI	1.00 lbs (455g)	1.09 lbs (495g)
Fixed Downlead (U174)	0.91 lbs (414g)	1.00 lbs (454g)
Fixed Downlead (U174), NFMI	0.99 lbs (447g)	1.07 lbs (487g)

All weights include batteries.

Sound Attenuation:

Frequency (Hz)		125	250	500	1000
With Headband	Mean Attenuation	16.7	18.7	23.2	25.4
	Standard Deviation	2.8	1.8	2.6	2.5
	Assumed Protection	13.9	16.9	20.6	22.9
With Helmet	Mean Attenuation	14.5	15.5	18.4	22.4
	Standard Deviation	4.4	2.0	3.9	4.3
	Assumed Protection	10.1	13.5	14.5	18.1

Frequency (Hz)		2000	4000	8000
With Headband	Mean Attenuation	34.8	43.8	44.7
	Standard Deviation	3.0	3.1	2.8
	Assumed Protection	31.8	40.7	41.9
With Helmet	Mean Attenuation	30.1	45.6	43.4
	Standard Deviation	5.6	5.9	7.2
	Assumed Protection	24.5	39.7	36.2

	SNR	H	M	L
With Headband	27	31	23	19
With Helmet	22	25	18	15

EU DECLARATION OF CONFORMITY

AMP Communication Headset

This declaration of Conformity is issued under the sole responsibility of the manufacturer:

Gentex Corporation
645 Harvey Rd
Manchester
NH 03103

To declare that the AMP Communication Headset manufactured at the above address is in conformity with the provisions of EU Regulation on Personal Protective Equipment EU2016/425 and with the harmonised European Standard EN 352-1:2002, EN352-2:2002 and EN 352-3:2002 for Hearing Protectors.

BSI Product Services, Netherlands (Notified Body 2797), has performed the EU type examination as per Annex V (Module B) of EU2016/425 and issued the EU Type examination Certificate No. CE 732116.

The PPE is subject to the conformity assessment procedure based on Quality System, as set out in Annex VIII (Module D) of the PPE Regulation EU 2016/425, under the surveillance of BSI Netherlands, Notified Body 2797.

Signed for and on behalf of:

Gentex Corporation
645 Harvey Rd, Manchester, NH 03103

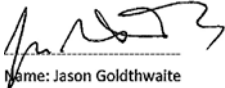

Name: Jason Goldthwaite

Title: Sr. Director/General Manager

Date: 7 July 2020

WARNING & WARRANTY

WARNING

This headset is used to reduce exposure to hazardous levels of noise and other sounds. This headset only provides the hearing protection noted in the product specification. This product should only be used in accordance with the provided instructions and should be properly fitted in accordance with the manufacturer's instructions. Avoid distractions while utilizing this product. Listening to music or other audio while using this product may result in decreased situational awareness. You should adjust the sound level to the lowest possible limit in order to minimize the risk of hearing damage. Remove any article of clothing or accessory that may interfere with the ear cup seal over the ear. Misuse, incorrect use, failure to follow instructions, or failure to follow cleaning and maintenance instructions may result in decreased or no protection and may result in serious injury.

WARRANTY

Unless an individual product is covered by a separately issued warranty, Gentex warrants that this product, and its components, accessories, peripherals, and parts will be free from defects in material or workmanship under normal use and service for a period of two (2) years from the date of delivery. All repair covered by this warranty shall be performed at Gentex's factory, or other such warranty repair facilities of Gentex as designated by Gentex unless Gentex specifically directs that repair services be performed at another location. Any defect corrected and found to be within this scope of the warranty will be repaired by Gentex and all charges for labor and material will be borne by Gentex. If it is determined that either no fault exists in Gentex, or the damage to be repaired was caused by negligence of the user, its agents, employees or customers, you agree to pay all charges associated with each such repair. No statement, recommendation or assistance made or offered by Gentex through its representatives to the user, its agents, employees, or customers in connection with the purpose or intended use of any Gentex's product shall be or constitute a waiver by Gentex of any of the provisions of this warranty or change Gentex's liability under this warranty.

EXCEPT WHERE PROHIBITED BY LAW, THE WARRANTY DESCRIBED ABOVE CONSTITUTES THE SOLE WARRANTY MADE BY GENTEX EITHER EXPRESSED OR IMPLIED. THERE ARE NO OTHER WARRANTIES EXPRESSED OR IMPLIED THAT EXTEND BEYOND THE FACE HEREOF, HEREIN, INCLUDING THE IMPLIED WARRANTIES OF MERCHANTABILITY AND FITNESS FOR A PARTICULAR PURPOSE. IN NO EVENT SHALL GENTEX BE LIABLE FOR ANY INCIDENTAL, CONSEQUENTIAL, OR SPECIAL DAMAGES EVEN IF ADVISED OF SUCH DAMAGES, AND THE USER, ITS AGENTS, EMPLOYEES, OR CUSTOMERS REMEDIES SHALL BE LIMITED TO SOLELY TO THE REPAIR OR REPLACEMENT OF NONCONFORMING UNITS OR PARTS, WHICH AMOUNT SHALL NOT EXCEED THE TOTAL PURCHASE PRICE OF THE PRODUCT UNDER WARRANTY.

Any tampering, misuse or negligence in handling or use of the product renders the warranty void. Further, the warranty is void if, at any time, the user, its agents, employees or customers attempts to make any internal changes to any of the components of a product; if at any time the power supplied to any part of the product exceeds the rated tolerance; if any external device attached by the user, its agents, employees or customers creates conditions exceeding the tolerance of the product; or if any time the serial number plate is removed or defaced. OPERATION OF THE PRODUCTS THAT RENDERS THIS WARRANTY VOID WILL BE DEFINED TO INCLUDE ALL OF THE POSSIBILITIES DESCRIBED IN THIS SECTION, TOGETHER WITH ANY PRACTICE THAT RESULTS IN CONDITIONS EXCEEDING THE DESIGN TOLERANCE OF THE PRODUCTS.



Copyright © 2021 Gentex Corporation. Ops-Core es una marca registrada de
Gentex Corporation o sus afiliados.