



High pressure washer
Original instructions

Nettoyeur haute pression
Traduction des instructions originales

EN

FR

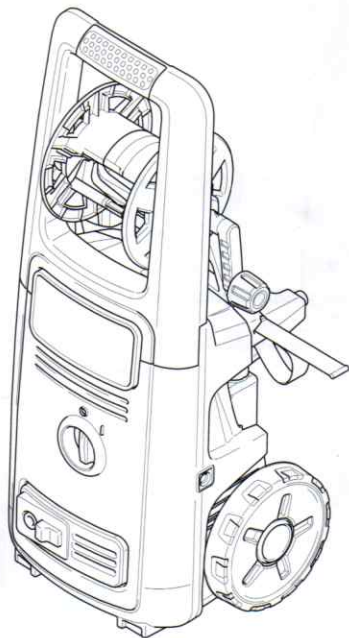

BXPW2500

cod. 95971 - GK

www.blackanddecker.eu

EN Please read these instructions carefully before use. Please retain these instructions for future reference. In case of problems or difficulties, please contact the consumer helpline: support@annovireverberi.it Page: 8-17

FR Lire attentivement ces instructions avant emploi. Conserver ces instructions pour toute consultation à venir. En cas de problèmes ou de difficultés, contacter l'assistance consommateur : support@annovireverberi.it Page : 18-28

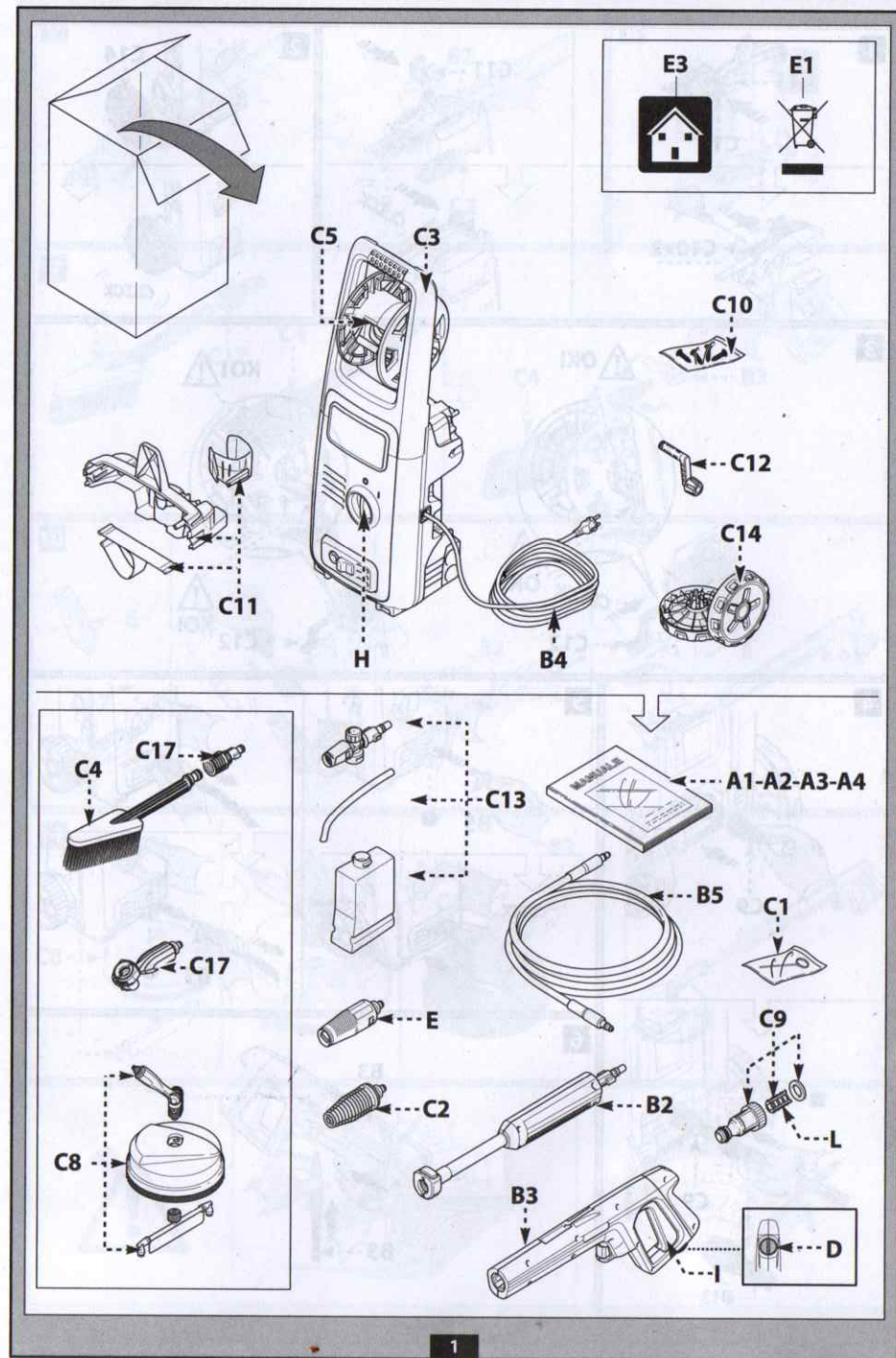

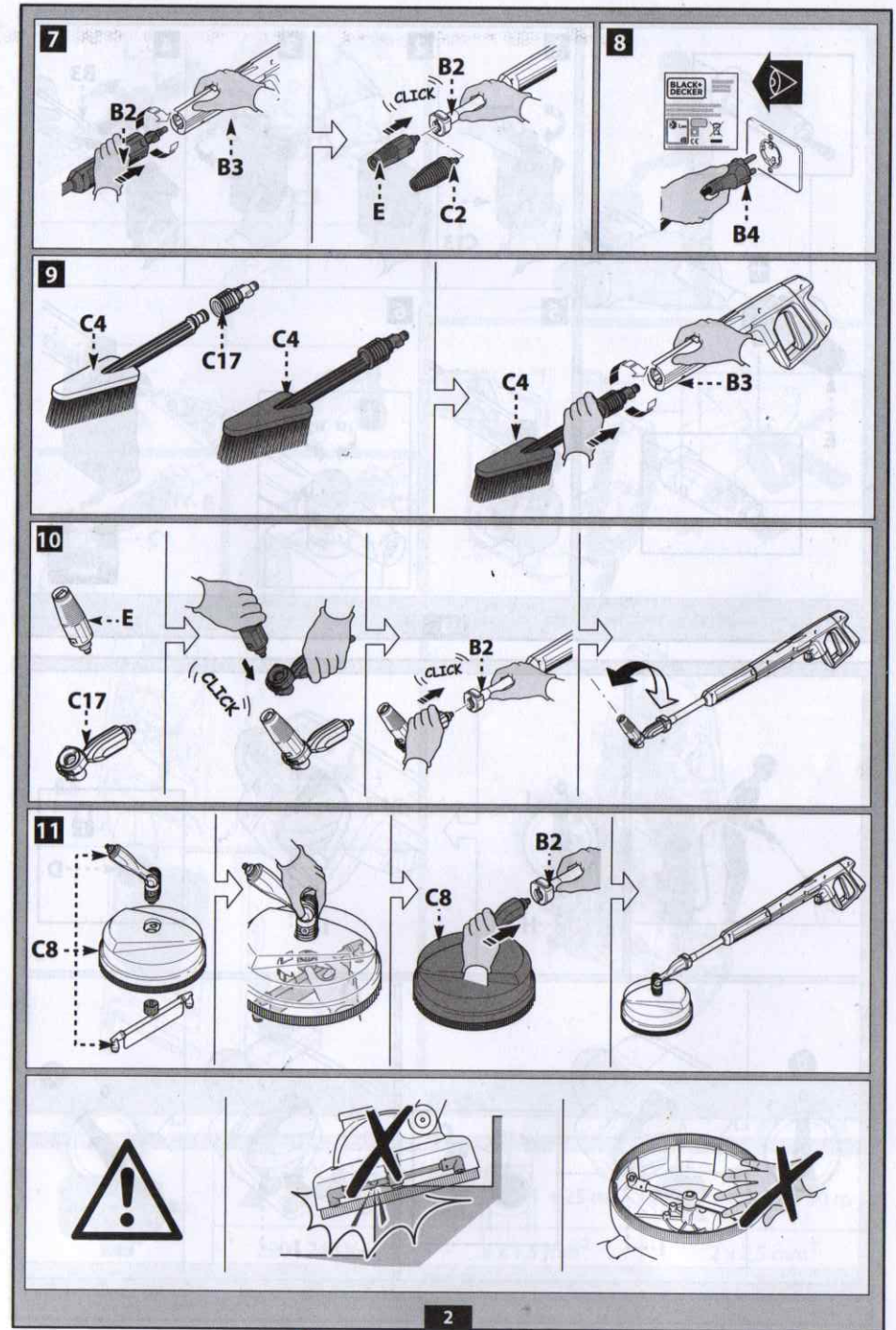
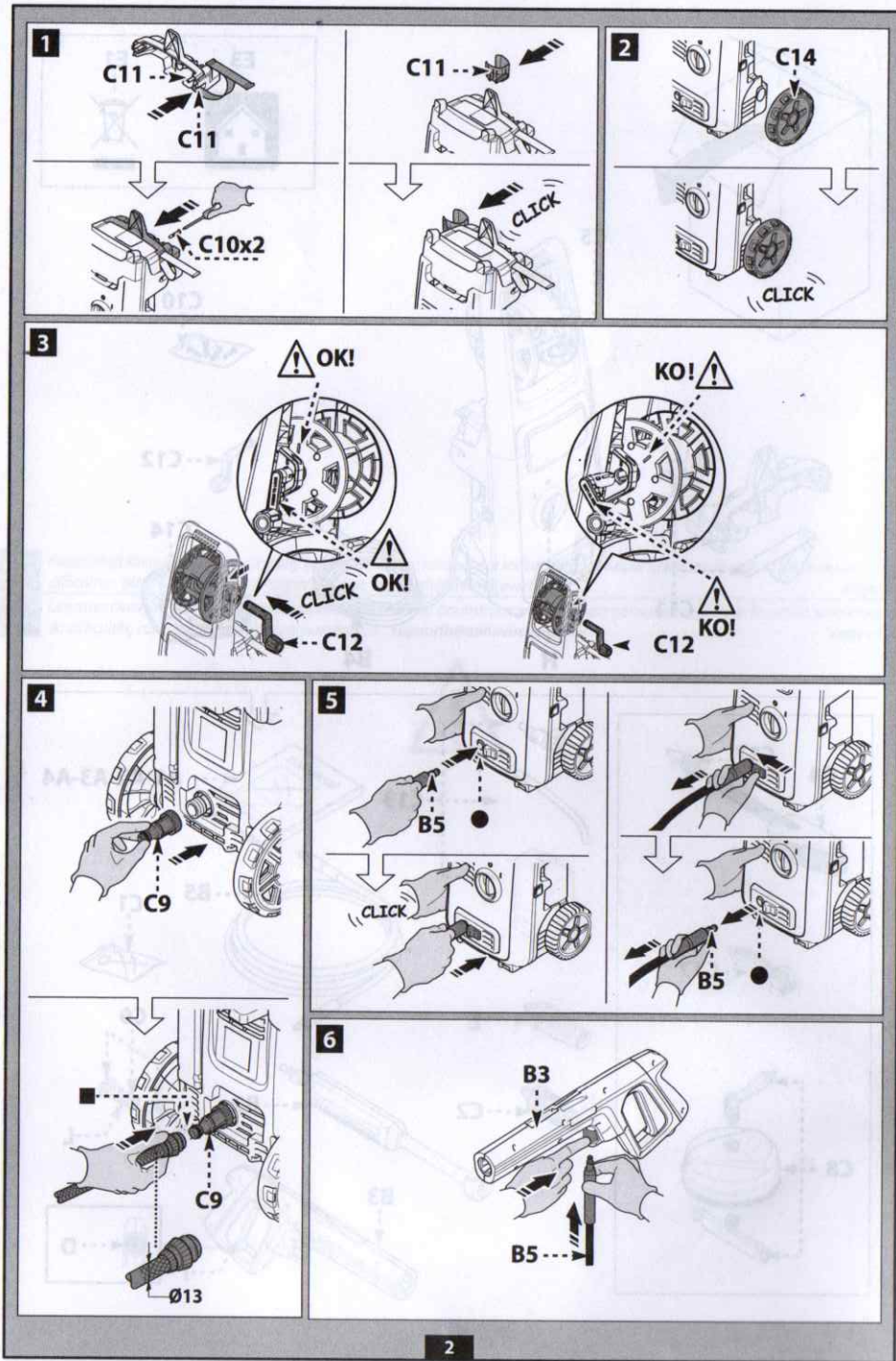

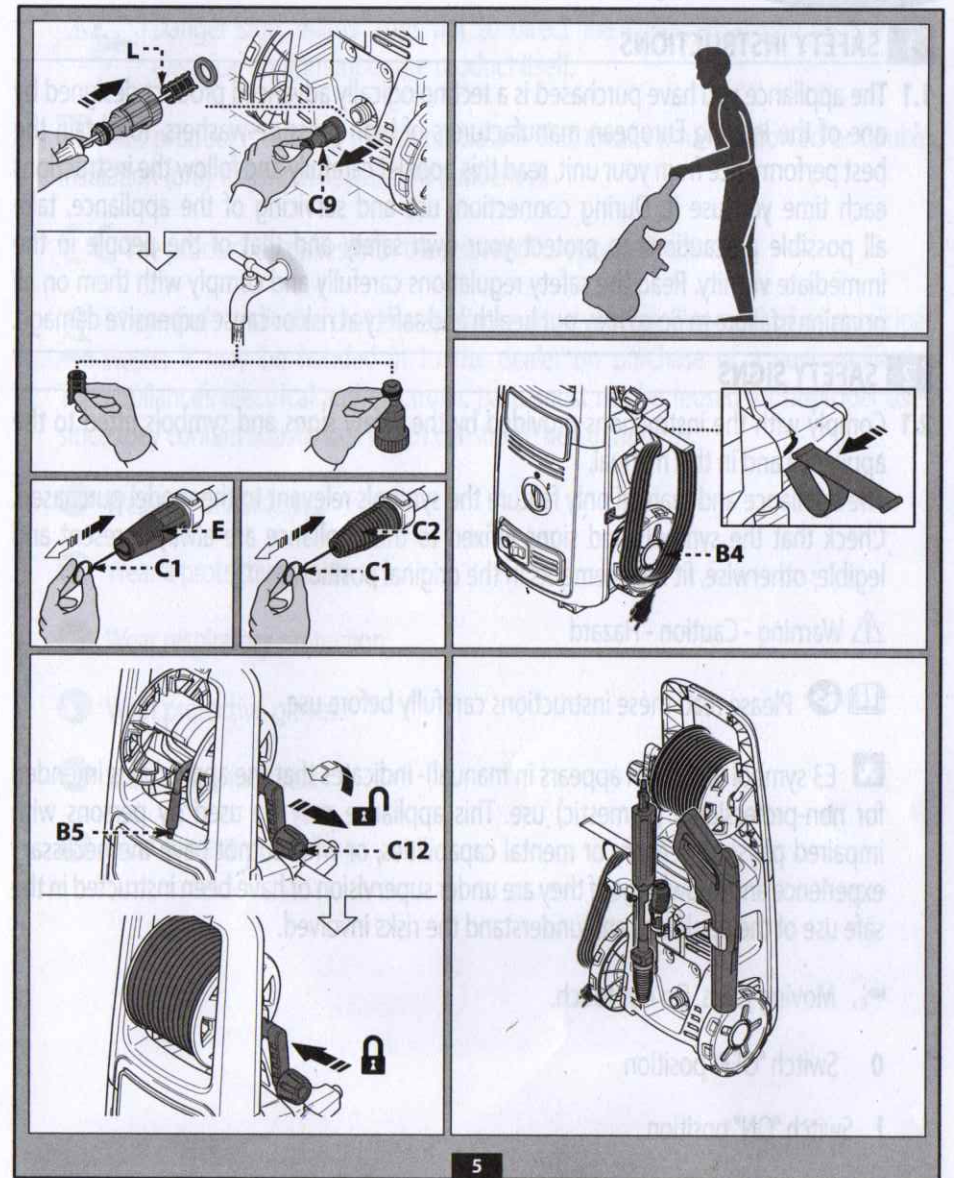
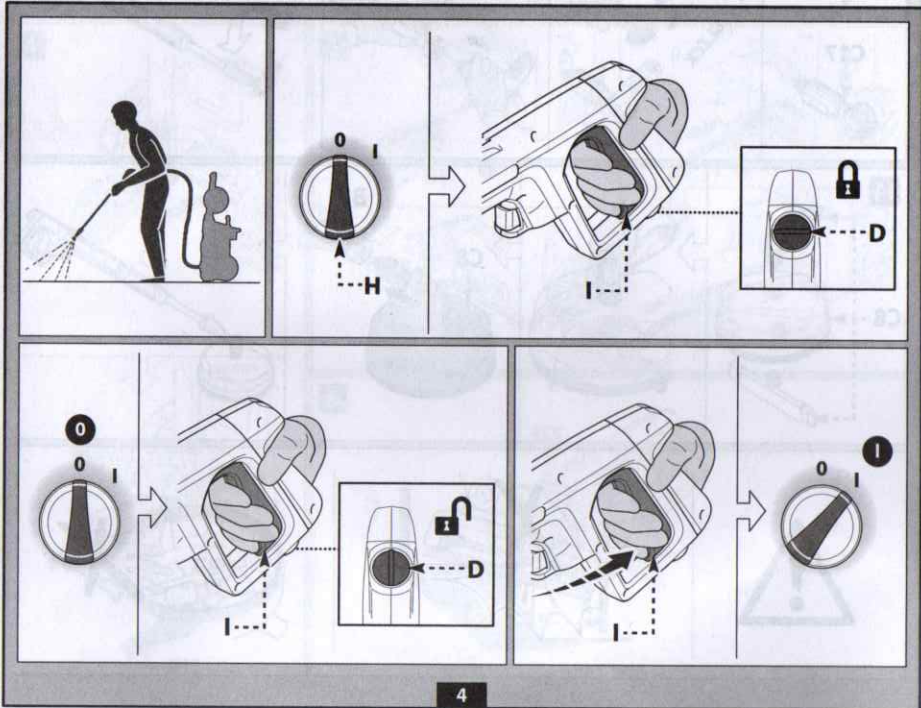
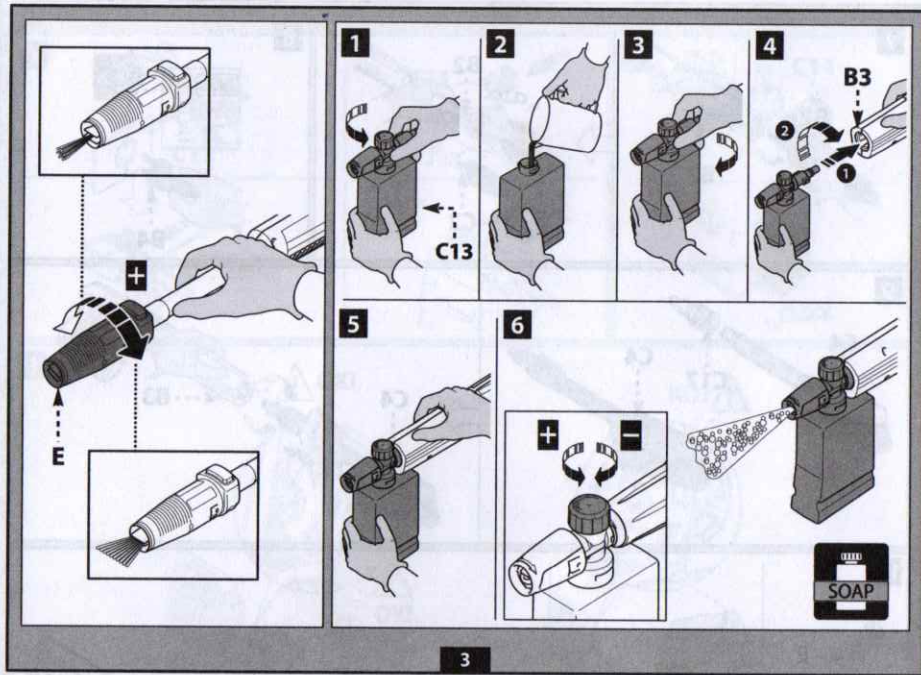

	Volt	1 ÷ 25 m	25 ÷ 50 m
	220 - 240 V~	2 x 1,5 mm ²	2 x 2,5 mm ²

1

1 SAFETY INSTRUCTIONS

1.1 The appliance you have purchased is a technologically advanced product designed by one of the leading European manufacturers of high pressure washers. To obtain the best performance from your unit, read this booklet carefully and follow the instructions each time you use it. During connection, use and servicing of the appliance, take all possible precautions to protect your own safety and that of the people in the immediate vicinity. Read the safety regulations carefully and comply with them on all occasions; failure to do so may put health and safety at risk or cause expensive damage.

2 SAFETY SIGNS

2.1 Comply with the instructions provided by the safety signs and symbols fitted to the appliance and in this manual.

The appliance and manual only feature the symbols relevant to the model purchased. Check that the symbols and signs affixed to the appliance are always present and legible; otherwise, fit replacements in the original positions.

 Warning - Caution - Hazard

 Please read these instructions carefully before use.

 E3 symbol (if symbol appears in manual)- Indicates that the appliance is intended for non-professional (domestic) use. This appliance may be used by persons with impaired physical, sensory or mental capabilities, or who do not have the necessary experience and knowledge, if they are under supervision or have been instructed in the safe use of the appliance and understand the risks involved.

 Moving parts. Do not touch.

 Switch "OFF" position

 Switch "ON" position

 Guaranteed sound power level

 Prohibition sign, informs users that local regulations may prohibit connection of the product to the drinking water supply system.



Danger sign, warns users not to direct the water jet at people, animals, electrical equipment or the product itself.



This product is rated in insulation class II. This means it has reinforced or double insulation (only if symbol appears on appliance).



The product complies with the relevant European directives.



E1 symbol - Indicates that the appliance **must not be disposed of** as municipal waste; it may be handed in to the dealer on purchase of a new appliance. The appliance's electrical and electronic parts must not be reused for improper uses since they contain substances which constitute health hazards.



Wear ear defenders.



Wear a protective mask.



Wear respiratory protection.



Wear protective gloves.



Wear safety footwear.









Wear protective clothing.



3 SAFETY RULES/RESIDUAL RISKS**3.1 SAFETY "DO NOTS"**

- 3.1.1 WARNING.** DO NOT allow children to use the appliance; supervise them to ensure that they do not play with it.
- 3.1.2 WARNING.** High pressure jets may be dangerous if incorrectly used.
- 3.1.3 WARNING.** DO NOT use the appliance with flammable or toxic liquids, or any products which are not compatible with its correct operation. Use of the appliance in a potentially inflammable or explosive atmosphere is forbidden.
- 3.1.4 WARNING. RISK OF EXPLOSION.** DO NOT use the appliance to spray flammable liquids.
- 3.1.5 WARNING.** DO NOT point the water jet at people or animals.
- 3.1.6 WARNING.** DO NOT point the water jet at the unit itself, electrical parts or other electrical equipment.
- 3.1.7 WARNING.** DO NOT use the appliance with people within its range of action unless they are wearing protective clothing.
- 3.1.8 WARNING.** DO NOT point the jet at yourself or others to clean clothing or footwear.
- 3.1.9 WARNING.** DO NOT use the appliance outdoors when it is raining.
- 3.1.10 WARNING.** DO NOT allow children, incompetent persons or those who have not read and understood the instructions to use the appliance.
- 3.1.11 WARNING.** DO NOT touch the plug and/or socket with wet hands.
- 3.1.12 WARNING.** DO NOT use the appliance if the electric cable is damaged. If the electric cable is damaged, it must be replaced by the manufacturer, one of its authorised Service Centres or similarly qualified persons in order to avoid a safety hazard.
- 3.1.13 WARNING.** DO NOT use the appliance if a supply cable or important parts such as the safety devices, high pressure hoses or gun are damaged.
- 3.1.14 WARNING.** DO NOT jam the trigger in the operating position.
- 3.1.15 WARNING.** Check that the data plate is affixed to the appliance; if not, inform your dealer. Appliances without plates must NOT be used as they are unidentifiable and potentially dangerous.
- 3.1.16 WARNING.** DO NOT tamper with or adjust the setting of the safety valve or the safety devices.
- 3.1.17 WARNING.** DO NOT alter the original diameter of the spray head nozzle.



- 3.1.18 WARNING.** DO NOT move the appliance by pulling on the ELECTRIC CABLE.
- 3.1.19 WARNING.** DO NOT allow vehicles to drive over the high pressure hose.
- 3.1.20 WARNING.** DO NOT move the appliance by pulling on the high pressure hose.
- 3.1.21 WARNING.** When directed towards tyres, tyre valves or other pressurised components, the high pressure jet is potentially dangerous. Do not use the rotating nozzle kit, and always keep the jet at a distance of at least 30 cm during cleaning.
- 3.1.22 WARNING.** The use of non-original accessories and any other spare parts not specifically intended for the model in question is prohibited. All modifications to the appliance are prohibited; any modifications shall render the Declaration of Conformity null and void and relieve the manufacturer of all liability under civil and criminal law.
- 3.2 SAFETY "MUSTS"**
- 3.2.1 WARNING.** All electrical conductors MUST BE PROTECTED against the water jet.
- 3.2.2 WARNING.** The electric supply connection must be made by a qualified electrician and comply with IEC 60364-1. Either a residual current device that will cut off the power supply if the leakage current to earth exceeds 30 mA for 30 ms or a ground fault interrupt device must be installed.
- 3.2.3 WARNING.** DURING start-up, the appliance may cause network noise.
- 3.2.4 WARNING.** Use of a residual current breaker (RCB) will provide additional protection for the operator (30 mA).
- 3.2.5 WARNING.** Models supplied without plug must be installed by qualified staff.
- 3.2.6 WARNING.** Use only approved electrical extension leads with suitable conductor cross-section.
- 3.2.7 WARNING.** Always turn off the switch when leaving the appliance unattended.
- 3.2.8**      
WARNING. High pressure may cause parts to rebound: wear all the protective clothing (PPE) and equipment needed to ensure the operator's safety.
- 3.2.9 WARNING.** Before doing work on the appliance, REMOVE the plug.
- 3.2.10 WARNING.** Before pressing the trigger, GRIP the gun firmly to counteract the recoil.
- 3.2.11 WARNING. COMPLY WITH** the local water supply authority regulations. Under IEC 60335-2-79, the appliance may only be connected to the mains drinking water supply if the supply hose is fitted with a backflow preventer valve with drain facility corresponding to EN 12729 type BA. The backflow preventer can be ordered from the manufacturer.



- 3.2.12 WARNING.** Water that has passed through backflow preventers is considered to be non-potable.
- 3.2.13 WARNING.** Maintenance and/or repair of electrical components **MUST** be carried out by qualified staff.
- 3.2.14 WARNING.** DISCHARGE residual pressure before disconnecting the hose from the appliance.
- 3.2.15 WARNING.** CHECK before each use and at regular intervals that the screws are fully tightened and that there are no broken or worn parts.
- 3.2.16 WARNING.** ONLY USE detergents which will not corrode the coating materials of the high pressure hose / electric cable.
- 3.2.17 WARNING.** ENSURE that all people or animals keep a minimum distance of 16 yd. (15m) away.
- 3.2.18 WARNING.** This appliance is designed for use with the detergent supplied or recommended by the manufacturer. The use of other detergents or chemicals may adversely affect the appliance's safety.
- 3.2.19 WARNING.** Do not allow the detergent to come into contact with the skin, and the eyes in particular! In case of contact with eyes, rinse with plenty of water and seek medical advice at once!
- 3.2.20 WARNING.** High pressure hoses, fittings and joints are important for the appliance's safety. Use only hoses, fittings and joints recommended by the manufacturer.
- 3.2.21 WARNING.** To ensure the appliance's safety, only use the manufacturer's genuine parts, or other parts which carry its approval.
- 3.2.22 WARNING.** If an extension cord is used, the plug and socket must be of watertight construction.
- 3.2.23 WARNING.** Unsuitable extension cables can be dangerous. If an extension cable is used, it must be suitable for outdoor use, and the connection must be kept dry and off the ground. Use of a power cable reel which keeps the socket at least 60 mm above the ground is strongly recommended.
- 3.2.24 WARNING.** Switch the appliance off and disconnect it from the power supply before assembly, cleaning, adjustments, maintenance, storage and transportation.
- 3.2.25 WARNING.** Insert the pipe jet kit down to the red mark before turning the appliance on.



4 GENERAL INFORMATION (FIG.1)/PAGE 3

- 4.1 Use of the manual**
The manual forms an integral part of the appliance and should be kept for future reference. Please read it carefully before installing/using the unit. If the appliance is sold, the seller must pass on this manual to the new owner along with the appliance.
- 4.2 Delivery**
The appliance is delivered partially assembled in a cardboard box. The supply package is illustrated in fig.1.
- 4.2.1 Documentation supplied with the appliance**
- A1 Use and maintenance manual
 - A2 Safety instructions
 - A3 Declaration of conformity
 - A4 Warranty regulations
- 4.3 Disposing of packaging**
The packaging materials are not environmental pollutants but must still be recycled or disposed of in compliance with the relevant legislation in the country of use.

5 TECHNICAL INFORMATION (FIG.1)/PAGE 3

- 5.1 Envisaged use**
This appliance has been designed for individual use for the cleaning of vehicles, machines, boats, masonry, etc., to remove stubborn dirt using clean water and biodegradable chemical detergents. Vehicle engines may be washed only if the dirty water is disposed of as per regulations in force.
- Intake water temperature: see data plate on the appliance.
 - Intake water pressure: min. 0.1 MPa - max. 1 MPa.
 - Operating ambient temperature: above 0°C.
- The appliance is compliant with the IEC 60335-1 and IEC 60335-2-79 standards.
- 5.2 Operator**
The symbol illustrated in fig. 1 identifies the appliance's intended operator (professional or non-professional).
- 5.3 Main components**
- B2 Lance
 - B3 Gun with safety catch
 - B4 Electric cable with plug (on models with this feature)
 - B5 High pressure hose
 - B6 Detergent tank (on models with this feature)
 - B7 Oil cap (on models with this feature)
 - E Nozzle
 - F Detergent regulator (on models with this feature)
 - G Pressure regulator (on models with this feature)
 - L Water filter
- 5.3.1 Accessories (if included in the supply package - see fig.1)**
- | | |
|-------------------------------------|-----------------------------|
| C1 Nozzle cleaning tool | C9 Adapter |
| C2 Rotating nozzle kit | C10 Screws |
| C3 Handle | C11 Brackets |
| C4 Brush | C12 Lever |
| C5 Hose reel | C13 Detergent kit |
| C6 Water suction kit | C14 Wheels |
| C7 Pipe jet kit | C15 Lubricating grease tube |
| C8 Large surface cleaning brush kit | C16 Pressure gauge |
| | C17 Accessories adapter |

5.4 Safety devices

- Starter device (H)
The starter device prevents accidental use of the appliance.

- Warning - danger!**
Do not tamper with or adjust the safety valve setting.
- Safety valve and/or pressure limiting valve.
The safety valve is also a pressure limiting valve. When the gun trigger is released, the valve opens and the water recirculates through the pump inlet or is discharged onto the ground.

6 INSTALLATION (FIG.2)/PAGE 4-5

- 6.1 Assembly**
- Warning - danger!**
All installation and assembly operations must be performed with the appliance disconnected from the mains power supply.
The assembly sequence is illustrated in fig.2.
- 6.2 Fitting the pressure release caps** (on models with this feature)
To prevent oil leaks, the appliance is delivered with the oil intakes sealed with red caps which must be replaced with the pressure release caps supplied.
- 6.3 Fitting the rotating nozzle** (For models with this feature).
The rotating nozzle kit delivers greater washing power. Use of the rotating nozzle may cause a reduction in pressure of 25% compared to the pressure obtained with the adjustable nozzle. However, the rotating nozzle kit delivers greater washing power due to the rotation of the water jet.
- 6.4 Electrical connection**
- Warning - danger!**
Check that the electrical supply voltage and frequency (V-Hz) correspond to those specified on the data plate (fig.2).
- 6.4.1 Use of extension cables**
The cross-section of the extension cable should be proportionate to its length; the longer it is, the greater its cross-section should be. See table 1.
- 6.5 Water supply connection**
- Warning - danger!**
Only clean or filtered water should be supplied to the appliance. The flow rate of the water inlet tap should be equal to the pump flow rate.
Place the appliance as close to the water supply system as possible.
- 6.5.1 Connection points**
- Water outlet (OUTLET)
 - Water inlet with filter (INLET)
- 6.5.2 Connection to the mains water supply**
The appliance may only be connected directly to the mains drinking water supply if the supply hose is fitted with a backflow preventer valve as per current regulations in force. Make sure that the hose is at least Ø 13 mm, that it is reinforced and that it is not more than 25 m long.
- 6.5.3 Suction of water from open containers**
- 1) Screw the inlet hose with filter to the water INLET and insert it down to the bottom of the container.
 - 2) Vent the air from the appliance:
 - a) Unscrew the lance.
 - b) Start the appliance and keep the gun open until there are no air bubbles in the water flowing out.
 - 3) Switch the appliance off and screw the lance back on.
N.B: the maximum suction height is 0.5 m. The suction hose should be filled before use.

7 ADJUSTMENTS (FIG.3)/PAGE 6

- 7.1 Adjusting the spray nozzle** (for models with this feature)
Water flow is adjusted by regulating the nozzle (E).

7.2 Adjusting the detergent

To deliver detergent at the correct pressure, set the nozzle (E) (where fitted) on "■" or fit the detergent kit (C13) (where available) as shown.

The quantity of detergent delivered is adjusted using the regulator (F).

7.3 Adjusting the working pressure (on models with this feature)

The regulator (G) is used to adjust the working pressure. The pressure is shown on the pressure gauge (where fitted).

8 INFORMATION ON USE OF THE APPLIANCE (FIG.4)/PAGE 6**8.1 Controls**

- Starter device (H).

Set the starter switch on (ON/I) to:

- start the motor (in models without TSS device);
 - set the motor ready to start (in models with TSS device).
- If there is a pilot light on the starter device, it should light up. Set the starter device switch on (OFF/O) to stop the appliance. If there is a pilot light on the starter device, it should go out.
- Water jet control lever (I).

Warning - danger!
During operation the appliance must be positioned as shown in fig. 4 on a firm, stable surface.

8.2 Start-up (see fig. 4)

- Turn on the water supply tap fully.
- Release the safety catch (D).
- Depress the gun trigger for a few seconds and start up the appliance using the starter device (ON/I).

Warning - danger!
Before starting up the appliance check that it is receiving water correctly; use of the appliance without water will damage it. Do not cover the ventilation grilles when the appliance is in use.

TSS models - In TSS models with automatic delivery flow cut-off system:

- when the gun trigger is released the dynamic pressure automatically cuts out the motor;
- when the gun trigger is depressed the automatic drop in pressure starts the motor and the pressure is restored after a very slight delay;
- if the TSS is to function correctly, all gun trigger releasing and depressing operations must be at least 4-5 seconds apart.

To prevent damage to the appliance, do not allow it to operate dry and check that it is properly supplied with water. For models without TSS, to prevent damage to the appliance due to an increase in water temperature, do not cut off the jet of water for more than 5 minutes with the appliance running.

8.3 Stopping

- Set the starter device switch on (OFF/O).
- Depress the gun trigger and discharge the residual pressure inside the pipes.
- Engage the safety catch (D).

8.4 Restarting

- Release the safety catch (D).
- Depress the gun trigger and discharge the residual air inside the pipes.
- Set the starter device on (ON/I).

8.5 Storage

- Turn off the water supply tap.
- Discharge the residual pressure from the gun until all the water has come out of the appliance.
- Switch the appliance off (OFF/O).
- Remove the plug from the socket.
- Drain and wash out the detergent tank at the end of the working session. To wash out the tank, use clean water instead of the detergent.
- Engage the gun safety catch (D).

8.6 Refilling and using detergent

The detergent must be delivered using the accessories and by the procedures described in point 7.2.

Use of a high pressure hose longer than the one originally supplied with the appliance, or the use of an additional hose extension, may reduce or completely halt the suction of detergent.

Fill the tank (B6) with highly biodegradable detergent.

8.7 Recommended cleaning procedure

Dissolve dirt by applying the detergent mixed with water to the surface while still dry.

When dealing with vertical surfaces work from the bottom upwards. Leave the detergent to act for 1-2 minute but do not allow the surface to dry. Starting from the bottom, use the high pressure jet at a minimum distance of 30 cm. Do not allow the rinse water to run onto unwashed surfaces.

In some cases, scrubbing with brushes is needed to remove dirt. High pressure is not always the best solution for good cleaning results, since it may damage some surfaces. The finest adjustable nozzle jet setting or the rotating nozzle should not be used on delicate or painted parts, or on pressurised components (e.g. tyres, inflation valves, etc.).

Effective cleaning depends on both the pressure and volume of the water used, to the same degree.

9 MAINTENANCE (FIG.5)/PAGE 7

Any maintenance operations not covered by this chapter should be carried out by an Authorised Sales and Service Centre.

Warning - danger!
Always disconnect the plug from the power socket before carrying out any work on the appliance.

9.1 Cleaning the nozzle

- Disconnect the lance from the nozzle.
- Remove any dirt deposits from the nozzle hole using the tool (C1).

9.2 Cleaning the filter

Inspect the inlet filter (L) and detergent filter (if fitted) before each use, and clean in accordance with the instructions if necessary.

9.3 Unjamming the motor (on models with this feature)

In case of lengthy stoppages, limescale sediments may cause the motor to seize. To unjam the motor, turn the drive shaft with a tool (M).

9.4 Refilling the oil (for models with this feature)

Add oil through the intake hole to restore the correct level. For oil characteristics, refer to the "Oil characteristics" table.

9.5 End-of-season storage

Treat the appliance with non-corrosive, non-toxic antifreeze before storing it away for winter. Put the appliance in a dry place, protected from frost.

10 STORAGE AND TRANSPORTATION (FIG. 5)/PAGE 7

Store the accessories as shown in fig. 5. Transport the machine as shown in fig. 5.

11 TROUBLESHOOTING

Problem	Possible causes	Remedy
Pump does not reach working pressure	Nozzle worn	Replace nozzle
	Water filter fouled	Clean filter (L) (fig.5)
	Insufficient water supply	Turn on water supply tap fully
	Air being sucked into system	Check tightness of hose fittings
	Air in pump	Switch off the appliance and keep depressing and releasing the gun trigger until the water comes out in a steady flow. Switch the appliance back on again.
	Adjustable nozzle not positioned correctly	Set nozzle (E) on (+) setting (fig.3)
Pump pressure drops suddenly during use	Thermostatic valve tripped	Wait for correct water temperature to be restored
	Water being sucked from an open container from a height of more than 0.5 m.	Reduce the suction height.
	Water being sucked from an external tank	Connect appliance to the mains water supply
Motor "buzzes" but fails to start	Inlet water too hot	Reduce temperature
	Nozzle clogged	Clean nozzle (fig.5)
	Inlet filter (L) fouled	Clean filter (L) (fig.5)
Motor fails to start	Power supply voltage too low	Check that the voltage of the mains power supply line is the same as that on the plate (fig.2)
	Voltage drop due to use of extension cable	Check characteristics of extension cable (I)
	Appliance not used for a long period of time	Contact your nearest Authorised Service Centre
Motor fails to start	Problems with TSS device	Contact your nearest Authorised Service Centre
	No electrical power	Check that the plug is firmly in the socket and that the mains voltage supply is present (*)
	Problems with TSS device	Contact your nearest Authorised Service Centre
Water leakage	Appliance not used for a long period of time	Using the tool (M) unjam the motor through the hole at the rear of the appliance (in models with this feature) (fig. 5)
	Seals worn	Have the seals replaced at your nearest Authorised Service Centre
Appliance noisy	Safety valve tripped and discharging	Contact an Authorised Service Centre
Oil leakage	Water too hot	Reduce temperature (see technical data)
TSS versions only: appliance starts even with gun trigger released	Seals worn	Contact your nearest Authorised Service Centre
TSS versions only: no water delivery when gun trigger is depressed (with supply hose connected)	High pressure system or pump circuit not watertight	Contact your nearest Authorised Service Centre
No detergent sucked in	Nozzle clogged	Clean nozzle (fig.5)
	Adjustable nozzle on high pressure setting	Set nozzle (E) on "■" setting (fig.3)
	Detergent too dense	Dilute with water
Water escapes from thermostat valve	High pressure hose extension being used	Fit original hose
	Deposits or restriction in detergent circuit	Flush with clean water and eliminate any restrictions. If the problem persists, contact an Authorised Service Centre

(*) If the motor stops and does not restart during operation, wait 2-3 minutes before repeating the start-up procedure (Overload cutout has been tripped). If the problem recurs more than once, contact your nearest Authorised Service Centre.



12 HOW TO AVOID DAMAGING SURFACES



WARNING

- 12.1 Using the appliance to wash tyres may damage the tyre and can be dangerous.
 12.2 Never point the high pressure jet straight at the tyre.
 12.3 Always use the appliance at the lowest pressure setting when cleaning in the vicinity of wheels and tyres.
 12.4 Never use the "Turbo Lance" for washing any part of the vehicle.
 12.5 For further information refer to section: "8.7 Recommended cleaning procedure".



EC Declaration of Conformity

We, Annovi Reverberi S.p.A, declare that the following Black+Decker Machine(s):

Designation of machine High pressure washer
 Model No. BXPW2500
 Rated power 2,5kW

conform(s) to the following European Directives: 2006/42/EC, 2014/35/EU, 2011/65/EU, 2015/863/EU, 2012/19/EU, 2014/30/EU and 2000/14/EC and are (is) manufactured in accordance with the following standards or standardised documents: EN 60335-1; EN 60335-2-79; EN 55014-1; EN 55014-2; EN 61000-3-2; EN 61000-3-3; EN 61000-3-11; EN 60704-1; EN 62233; EN 50581

Name and address of the person appointed to issue the technical file: Stefano Reverberi / AR Managing Director Via ML King, 3 - 41122 Modena, Italy

The conformity assessment procedure required by Directive 2000/14/EC has been performed in accordance with Annex V

Model No. BXPW2500
 Measured sound power level: 90,3 dB (A)
 Guaranteed sound power level: 93 dB (A)

Date: 28.07.2020

MODENA (I)

Stefano Reverberi

 Managing Director

WARRANTY

The validity of the warranty is in accordance with the relevant legislation in the country where the product is sold (unless otherwise stated by the producer). The warranty covers materials, construction and conformity defects during the warranty period, during which time the manufacturer will replace defective parts and repair the product if not excessively worn, or replace it.

The warranty does not cover components subject to normal wear and tear (valve, piston, water gasket, oil gasket, springs, O-rings, accessories such as the hose, gun, brushes, wheels, etc.);

The warranty does not cover defects caused by or arising from:

- improper use, misuse, negligence,
- hire or professional use if the product has been sold for domestic use,
- failure to comply with the maintenance instructions provided in this manual,
- repair by unauthorised staff or centres,
- use of non-genuine parts or accessories,
- damage caused by transport, by dirt or foreign bodies, accidents,
- storage or warehousing problems.

Proof of purchase must be submitted to obtain warranty cover.

For assistance, page: 29.

Technical Data

Technical Data	Unit	BXPW2500
Flow rate	l/min	5,5
Maximum flow rate	l/min	8,33
Pressure	MPa	11,5
Maximum pressure	MPa	17
Power	kW	2,5
Maximum inlet temperature	°C	50
Maximum inlet pressure	MPa	1
Gun repulsive force at maximum pressure	N	13,9
Pump oil type	kg	-
Protection class	-	II/□
Motor insulation	Class	F
Motor protection	-	IPX5
Voltage	V~/Hz	220-240 / 50-60
Maximum permitted electrical system impedance	Ω	0,275
Sound pressure level L_{pA} (EN 60704-1)(K=2,5 dB(A))	dB (A)	78,8
Sound power level L_{WA} (EN 60704-1)(K=2,5 dB(A))	dB (A)	93
Appliance vibration (K=1 m/s ²):	m/s ²	<2,5
Weight	kg	8,4

Subject to technical modification!