

C127

- Display Logger



USER MANUAL

MoTeC

Copyright © 2015 – MoTeC Pty Ltd

The information in this document is subject to change without notice.

The supplied product may differ slightly to the images

While every effort is taken to ensure correctness, no responsibility will be taken for the consequences of any inaccuracies or omissions in this manual.

Version 1.3, May 2018

Contents

Introduction.....	6
Features	6
System Overview.....	8
Typical devices used with the Display Logger.....	8
C127 Race Kits.....	12
C127 Race Display Kit	12
C127 Race Logging Kit	12
Installing the C125 Terminated Loom.....	13
Installing the C125 Input Loom.....	14
Installing the OBD-II To Display Loom.....	15
Installing the CAN ECU To Display Loom.....	16
Installing the RS232 ECU To Display Loom	18
Installation.....	20
Mounting and Wiring.....	20
Connecting Devices.....	21
Inputs – Requires I/O Upgrade	21
Outputs – Requires I/O Upgrade	23
Communications	24
Connecting Devices Examples.....	25
Software Installation.....	26
C127 Dash Manager Software	26
i2 Data Analysis Software	27
Connecting the Display Logger to a PC.....	27
Configuration	29
Configuration Sequence.....	29
Configuration File.....	29
Channels	30
Channel Properties	32
Selecting Channels	33
Connections.....	35
Configuring Inputs (optional)	35

Configuring Outputs (optional).....	35
Configuring Communications	35
Calculations.....	36
Special Calculations.....	36
General Purpose Calculations.....	36
Functions.....	37
Data Logging (optional)	37
Display Using Fixed Layouts	41
Display Setup with Display Creator.....	49
Alarms	51
Other Functions	52
Operation.....	53
Retrieving the Logged Data.....	53
Sending and Retrieving Configuration Files.....	53
Zeroing Sensors	53
Checking Operation	54
Configuration Versions and Updating	54
Upgrading the Display Logger	55
Password Protection	55
Other Online Activities.....	55
Appendices	57
Specifications	57
Display Logger Upgrades.....	60
Characteristics.....	61
Input Characteristics	61
Output Characteristics.....	66
C127 Pin List by Pin Number	67
C127 Pin List by Function	68
Mounting Dimensions	70
Wiring.....	71
Connector	71
Wire Specification	71
PC Connection.....	72
CAN Bus Wiring Requirements	73

C127 Display Logger to ECU wiring (RS232).....	74
C125 Race Loom Terminated Wiring (part 62204).....	75
Update Rate Summary.....	76
Command Line	78
CAN Bus Bandwidth Limit	80
Comms Error Codes	81
Windows Keyboard Shortcuts	84
Screen Cleaning	88
Glossary	89

Introduction

C127 - Club Display Logger

The C127 comes standard as a combined 7" full colour display and powerful control device that is readable in direct sunlight. With the addition of the Data Logging upgrade it becomes a fully programmable data logger with 120 MB memory (see [Display Logger Upgrades](#)).

Displayed channels, labels and colours are configurable on a diverse set of supplied layouts; alternatively, use Display Creator software to create fully configurable custom layouts. The C127 acquires data from devices such as an ECU and displays data channels, warning alarms, lap times, fuel calculations and much more.

Features

All MoTeC Displays come with a range of features as standard and several options available as upgrades to customise and grow the system. These additional features are activated through a simple password system, and can be purchased at any time when you need them.

See [Display Logger Upgrades](#).

General

- All-in-one display, logger (optional) and controller eliminates the need for separate devices
- 16 full colour (RGB) LEDs; colour, function and intensity are fully programmable
- Suitable for cars, marine and industrial applications
- Compact, durable and reliable unit
- Supports Wideband Lambda from MoTeC PLMs or LTCs, using Bosch LSU or NTK UEGO 5 wire sensors
- Straightforward control for lights, fans, pumps (optional)
- Easily integrates with MoTeC CAN based products such as ECUs and expanders. Full I/O expansion available with use of E888, E816.
- GPS Lap Timing

Logging and Analysis

- Optional internal data logging of 120 MB
- Fast download via Ethernet
- Data analysis with **i2 Standard** or optional **i2 Pro** software

- Accommodates over 300 channels derived from a mixture of analogue and digital inputs, RS232 and CAN data channels
- Configurable to use sensors from some existing engine management systems

Display

- High resolution 178 mm (7") anti-reflective colour LCD display, with high brightness for sunlight readability
- 10 customisable layout options with diverse colour schemes, or purchase the Display Creator software to create fully configurable custom layouts.
- Customisable measurement units and warnings
- Configurable dial, sweep or bar graph can display any channel with optional peak, hold and shift markers
- 48 user-defined alarms, e.g. Low Oil Pressure, Low Fuel, Fast Lap
- Programmable overrides - particularly useful for showing values such as lap times
- Three programmable modes or 'pages' with customisable labels ensure the driver is shown only the most relevant information at any given time
- Adjustable backlight

Software

- Windows-based software designed for setup and management of the display and data logging system
- The user can generate a configuration file offline and send the completed configuration to the Display Logger
- Calculations including lap times, lap gain/loss, speed and distance, fuel prediction
- Monitor active channels—view all channels live
- Sensor zeroing
- Details editor including event, venue and vehicle details
- Extensive Help screens
- To access the newest software features you can download the latest version from www.motec.com/downloads

Compatibility

- MoTeC ECUs: M4, M48, M8, M84, M400, M600, M800 and M880
- MoTeC accessories: E816, E888, SLM, PLM, LTC, BR2, PDM, GPS, PDM, etc.
- Many non-MoTeC ECUs and other devices

Required Accessories

See to [Connecting the Display Logger to a PC.](#)

- #61225 Network Cable RJ45 1.5 Metre, or other standard ethernet cable

Optional Kits and Accessories

- Any one of the following:
 - 18037 Race Display Kit
 - 18038 Race Logging Kit
- 62204 C125 Race Loom Terminated
- 61259 C125 Input Loom
- 61197 OBD-II To Display Loom
- 61198 CAN ECU To Display Loom
- 61199 RS232 ECU To Display Loom
- 41304 GPS L10 10Hz
- 61221 Two Button Loom

System Overview

The Display Logger offers extensive possibilities to integrate with ECUs, peripheral devices and accessories to form a complete solution that powers, controls, logs, monitors and communicates virtually any automotive parameter.

Typical devices used with the Display Logger

ECUs

The C127 Display Logger can be connected to all MoTeC engine management systems and some other manufacturers' ECUs either via CAN, RS232 or OBD-II. This avoids duplication of sensors and allows the Display Logger to display and log many ECU parameters.

The typical update rate is about 20 times per second for RS232 and 50 times per second for CAN, but is less from OBD-II.

Sensors

The optional Display Logger inputs* can be connected to a wide variety of sensors. Different types of sensors are available to suit different types of measurements, for example: temperature, pressure, movement etc.

Sensors convert a physical measurement (e.g. pressure) into an electrical signal (e.g. volts).

Different types of sensors generate different types of electrical signals. For example, most temperature sensors convert the temperature into a variable resistance which may be measured by an Analogue Temperature input. However most wheel speed sensors generate a variable frequency signal which must be connected to either a Digital input or a Speed input.

**To use these inputs, you will need to add the #29800 C127 I/O enable.*

Expanders

E888/E816

The C127 fully supports two E888 or E816 Expanders allowing expansion of the number of inputs and outputs

Accessories

BR2

A BR2 Beacon Receiver may be connected to the C127, which allows the Display Logger to calculate lap times for display and to provide lap information for the data analysis software.

SLM-C

The SLM-C Club Shift Light Module can be used for shift lights, warning lights and other driver alerts.

The SLM-C includes 8 coloured LEDs that can be programmed to display in a pre-defined pattern.

GPS

The C127 Display Logger supports many GPS (Global Positioning System) devices allowing it to record speed and position information as well as providing lap timing.

This information can be used in the *i2* data analysis software to create track maps, and plot and compare driven lines.

A 10 Hz GPS is supplied as part of the C127 Race Kits.

High Definition Video

MoTeC brings true high definition to motorsport with its new HD Video Capture System. The HD-VCS provides superior quality video and numerous features designed specifically for the racing environment.

Features include:

- Genuine High Definition with 1080p @ 30 frames per second
- Automatic Start/Stop, eliminating the possibility of drivers forgetting to turn it on
- 12 V power direct from the vehicle - no batteries to recharge
- [Live gauges](#) automatically recorded on the video
- Over 5 hours of recording at 1080p
- Records to removable storage up to 32 GB
- Video can be played directly from the card
- Automatic CAN Synchronisation with data in i2 (available late 2013)
- Compact, lightweight recording unit

Lambda Measurement

PLM

The PLM Professional Lambda Meter measures the air fuel ratio over a wide range of mixtures with fast response time. It is compatible with Bosch LSU and NTK UEGO Lambda sensors and displays the Lambda readings via the integrated display.

LTC/LTCD/LTC NTK

LTC Lambda to CAN modules provide accurate Lambda measurements even when the exhaust gas temperature changes rapidly. They are compatible with the Bosch LSU 4.9 / NTK Lambda sensors and transmit Lambda readings via the CAN bus.

Remote Displays

A remote display device may be connected to the C127 to allow display of any value that the Display Logger calculates, such as lap times and warning alarm messages.

The Club Display Logger supports D153, D175 displays which are connected via CAN.

PDMs

Power Distribution Modules are designed to replace conventional relays, fuses and circuit breakers by providing electronically switched power to the various electrical systems in the vehicle. This simplifies wiring and switch requirements, while increasing reliability.

Full diagnostic information, including output currents and error status, can be transmitted via CAN to the Display Logger.

Several models are available to suit vehicles with different complexity ranging from 15 to 32 outputs and 12 to 23 inputs.

Other Devices

Many other devices can be connected to the C127 Display Logger.

C127 Race Kits

C127 Race Display Kit

The C127 Race Display Kit is a complete plug and play solution. All wires are labelled and terminated, ensuring a fast, easy installation.

The Race Display Kit will allow you to perform the following functions and more with your C127:

- Lap timing
- Shift lights
- Warnings
- Multiple page layouts
- ECU connection
- Display of sensor values

Kit contents:

- 18036 – C127 COLOUR DISPLAY LOGGER
- 61260 – C125 ACCESSORY KIT containing:
 - 41304 – GPS L10 10Hz
 - 61221 – TWO BUTTON LOOM
 - 61225 – NETWORK CABLE RJ45 1.5 METRE
 - 62204 – C125 RACE LOOM TERMINATED (this loom is used on both the C125 and C127)

C127 Race Logging Kit

The Race Logging Kit is a complete plug and play solution with data logging. All wires are labelled and terminated, ensuring a fast, easy installation.

The Race Logging Kit will allow you to perform the following functions and more with your C127:

- Lap timing
- Track Mapping
- Data Logging
- Shift lights
- Warnings
- Multiple page layouts

- ECU connection
- Display of sensor values
- Driver analysis
- Engine performance measurement
- Data analysis using MoTeC's *i2* software

Kit contents:

- 18036 – C127 COLOUR DISPLAY LOGGER
- 29818 – C127 120 MB LOGGING
- 61260 – C125 ACCESSORY KIT containing:
 - 41304 – GPS L10 10Hz
 - 61221 – TWO BUTTON LOOM
 - 61225 – NETWORK CABLE RJ45 1.5 METRE
 - 62204 – C125 RACE LOOM TERMINATED (this loom is used on both the C125 and C127)

Installing the C125 Terminated Loom

This loom is used on both the C125 and C127

The C127 has an optional terminated loom that is pre-configured to get the most out of your Display Logger. This loom plugs directly into the back of the C127, and has labelled wires for each of the parts that come with the Race Kit. The loom has these connections:

- **Power** - Connect to a 12 - 32 V power source and ground with a 5 ampere fuse. When using the C127 Race kits, use the cigarette lighter adapter.
- **GPS** - Ensure that you connect a compatible 5 V GPS unit only to the lead labelled "GPS". **Plugging a GPS into the Accessories lead will damage the GPS.**
- **Buttons** - Plug in the button loom as supplied with the kit for Mode, Alarm Acknowledge and Next Line functionality.
- **Accessories** – Use this lead to connect a MoTeC CAN based product to the C127, such as LTC, expander, HD-VCS
- **ECU** - ECU communications are sent to the C127 via this connector. Terminated looms are available for OBD-II, M84, MoTeC 'Hundred Series' ECUs and RS232 (M4, M48 and other brands).
- **Ethernet** - For communications between your Dash and a PC for configuration.

Installing the C125 Input Loom

The C125 Input loom is a fast way to add sensors to your C127 when you have added the I/O upgrade. Following these instructions, you can quickly add wiring for 6 AVs, 2 ATs, 2 Digital and 3 Speed inputs to your vehicle's loom.

Installation Process

1. Connect DTM 4 pin male of the Input loom to GPS DTM 4 pin female connector of the main loom.
2. Connect DTM 4 pin female connector of the Input loom to the GPS connector. The purpose of this connection is to supply 5 V and 0 V to the sensors.
3. Remove the main 34 pin C127 connector from the back of the C127.
4. Unlock the C127 connector by pushing in the long white locking tab.
5. Remove white plugs from pins 3, 4, 5, 6, 12, 13, 16, 17.
6. Insert pinned wires into the C127 connector as follows:
 - AV1 – blue wire into pin location 3
 - AV2 – green wire into pin location 4
 - AV3 – purple wire into pin location 5
 - AV4 – grey wire into pin location 6
 - AV5 – yellow wire into pin location 12
 - AV6 – white wire into pin location 13
 - AT1 – brown wire into pin location 16
 - AT2 – orange wire into pin location 17
7. Secure the pins in place by pushing in the two locking tabs on the C127 connector. If the two locking tabs are difficult to push back, this indicates that one of the inserted pins is not seated correctly.
8. Run the AV and AT wires to the locations required for your new sensors.

Notes:

- The red wires are 5 V
- The black wires are 0 V
- Coloured wires are the AV and AT wires
- You can shorten the looms as required by cutting them shorter
- You should loop and tie up unused looms for future use

Installing the OBD-II To Display Loom

The OBD-II loom is a terminated adapter that joins the C125 terminated loom (#62204) to the standard on-board diagnostics port on most road cars 2007 or later.

There is no standard location for the OBD-II socket in a road car, so you will have to search your vehicle to find its location. The most common place is in the driver's foot well, under the dash panel. In some instances it is directly accessible, other times you may need to remove a covering panel.

Installation method – if C127 came pre-configured

1. Plug in the C127, buttons and GPS. **DO NOT connect the OBD-II To Display Loom at this stage.**
2. Plug the cigarette lighter power adapter into a spare power supply socket.
3. Press and hold the red button on the button loom for at least 5 seconds. If correctly configured, "OBD-II" will display on the C127. **NOTE:** If "OBD-II" does not display, do not plug in the OBD-II To Display Loom and follow the *NOT pre-configured* instructions.
4. Plug the 4 pin DTMF connector into the connector labelled ECU.
5. Find the OBD-II connector and plug in the mating connector.
6. Start the car. Installation should now be complete.

Installation method – if C127 is NOT pre-configured

1. Plug in the C127, buttons and GPS. **DO NOT connect the OBD-II To Display Loom at this stage.**
2. Plug the cigarette lighter power adapter into a spare power supply socket
3. Connect a laptop to the C127 using the provided Ethernet lead
4. Start up C127 Dash Manager
5. Select **Tools > Connection settings** in C127 Dash Manager, then select **Add**
6. Select the **Search** button
7. Highlight the device displayed in the connected device window, and select the **Select** button
8. Select **OK** on the new IP screen
9. Select **OK** on the Connection settings screen
10. Select **File > New**
11. Select **C127 OBD2** configuration

12. Select **Online > Send Configuration** to put the OBD-II configuration in the Dash
13. Save the file with a new name, such as **“my start file”**
14. Choose **Yes**, or **Ok** to any warnings that display while this new configuration is sent to the Dash.
15. Press and hold the red button on the button loom for at least 5 seconds. If correctly configured, “OBD-II” will display on the C127. **NOTE:** If “OBD-II” does not display, do not plug in the OBD-II To Display Loom and contact your dealer.
16. Plug the 4 pin DTMF connector into the connector labelled ECU.
17. Find the OBD-II connector and plug in the mating connector.
18. Start the car. Installation should now be complete.

Installing the CAN ECU To Display Loom

The CAN ECU To Display Loom connects the C125 loom to a MoTeC CAN ECU via the CAN communications connector.

NOTE: The CAN communications connector is the socket that you would normally use to connect a UTC to your ECU for tuning.

Installation method – if C127 came pre-configured

1. Plug in the C127, buttons and GPS.
2. Connect the C125 to CAN ECU adapter loom to the ECU plug on your C125 loom. Plug the other end into your ECU communications connector.
3. Plug the cigarette lighter power adapter into a spare power supply socket. If your vehicle does not have a power supply socket, cut off the adapter and connect the red wire to a fused 12 V source and the black wire to chassis ground.
4. Power up the car, including turning on the MoTeC ECU. The number in the top right of the display should change to show the current Engine Temperature. **NOTE:** If the Engine Temperature is not displayed, then either your ECU or C127 isn't correctly configured. Follow the not pre-configured instructions.
5. The installation should now be complete.

Installation method – if C127 is NOT pre-configured

1. Plug in the C127, buttons and GPS.
2. Connect the C125 to CAN ECU adapter loom to the ECU plug on your

- C125 loom. Plug the other end into your ECU communications connector.
3. Plug the cigarette lighter power adapter into a spare power supply socket. If your vehicle does not have a power supply socket, cut off the adapter and connect the red wire to a fused 12 V source and the black wire to chassis ground.
 4. Connect a laptop to the C127 using the Ethernet lead provided.
 5. Start up C127 Dash Manager.
 6. Select **Tools > Connection settings** in C127 Dash Manager, then select **Add**.
 7. Select the **Search** button.
 8. Highlight the device displayed in the connected device window, and select the **Select** button.
 9. Select **OK** on the new IP screen.
 10. Select **OK** on the Connection settings screen.
 11. Select **File > New**
 12. Select **C127 M400 M600 M800** template if you have one of those ECUs, or select the **C127 M84** template.
 13. Select **Online > Send Configuration** to put the configuration in the Dash
 14. Save the file with a new name, such as “**my start file**”
 15. Choose **yes** or **ok** to any warnings that display while this new configuration is sent to the Dash.
 16. Power up the car, including turning on the MoTeC ECU. The number in the top right of the display should change to show the current Engine Temperature. **NOTE:** If the Engine Temperature is still not displayed, check ECU settings as shown below.
 17. The installation should now be complete.

ECU settings

Start ECU manager, and connect your UTC.

Select **Adjust > General setup > Communications > CAN Setup**

Set CAN 0 Data to 0

Set CAN 0 Address to 1520

Set CAN 0 Transfer Rate to 50

Installing the RS232 ECU To Display Loom

The RS232 ECU To Display Loom connects the C125 loom to an ECU via its RS232 communications connector.

NOTE: The RS232 communications connector is the socket that you would normally use to connect to your ECU for tuning.

Installation method – if C127 came pre-configured

1. Plug in the C127, buttons and GPS.
2. Connect the C125 to RS232 ECU adapter loom to the ECU plug on your C125 loom. Plug the other end into your ECU communications connector. An additional cable/adapter may be required in conjunction with the RS232 adapter for some ECU's.
3. Plug the cigarette lighter power adapter into a spare power supply socket. If your vehicle does not have a power supply socket, cut off the adapter and connect the red wire to a fused 12 V source and the black wire to chassis ground.
4. Power up the car, including turning on the ECU. The number in the top right of the display should change to show the current Engine Temperature.
NOTE: If the Engine Temperature is not displayed, then either your ECU or C127 isn't correctly configured. Follow the not pre-configured instructions.
5. The installation should now be complete.

Installation method – if C127 is NOT pre-configured

1. Plug in the C127, buttons and GPS.
2. Connect the C125 to RS232 ECU adapter loom to the ECU plug on your C125 loom. Plug the other end into your ECU communications connector. An additional cable/adapter may be required in conjunction with the RS232 adapter for some ECU's.
3. Plug the cigarette lighter power adapter into a spare power supply socket. If your vehicle does not have a power supply socket, cut off the adapter and connect the red wire to a fused 12 V source and the black wire to chassis ground.
4. Connect a laptop to the C127 using the Ethernet lead provided.
5. Start up C127 Dash Manager.
6. Select **Tools > Connection settings** in C127 Dash Manager, then select **Add**.
7. Select the **Search** button.

8. Highlight the device displayed in the connected device window, and select the **Select** button.
9. Select **OK** on the new IP screen.
10. Select **OK** on the Connection settings screen.
11. Select **File > New**
12. Select **C127 M4 M48** template if you have one of those ECUs. Other ECUs will require a custom template.
13. Select **Online > Send Configuration** to put the configuration in the Dash.
14. Save the file with a new name, such as **“my start file”**
15. Choose **yes** or **ok** to any warnings that display while this new configuration is sent to the Dash.
16. Power up the car, including turning on the ECU. The number in the top right of the display should change to show the current Engine Temperature.
NOTE: If the Engine Temperature is still not displayed, check ECU settings, as shown below.
17. The installation should now be complete.

ECU settings

Start M4/M48/M8 ECU Manager and connect the laptop.

Select **Adjust > General setup > Miscellaneous Setup 2**

Set Telemetry Baud Rate to 19201

Set Telemetry Data Set to 5

Installation

This section provides information on how to install the Display Logger in the vehicle and connect it to other devices. It will also provide information on how to install the software.

Mounting and Wiring

The Display Logger has three threaded mounting posts. For further details see [Mounting Dimensions](#).

Mounting Tips

- Avoid twisting the case: use washers between the unit and the mounting panel to ensure that the unit is mounted only at the mounting points and do not over tighten the mounting screws.
- Vibration isolation may be desirable if the vehicle vibrates severely.
- Mount so that the connector may be easily accessed.
- Orientation: for best contrast, the display should be viewed at an angle of approximately 20 degrees, however the Display Logger will provide good contrast between 0 and 40 degrees. Display reflections should also be considered when determining the mounting angle.

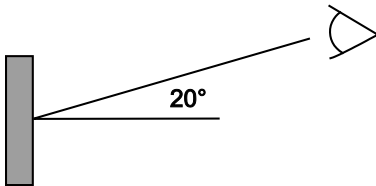

The C127 uses a 34 pin connector. See [Connector](#) and [C127 Pin List by Function](#) for full details.

Wiring Tips

- To ensure that the connector is sealed, plug unused holes with filler plugs.
- Use 22# Tefzel wire (Mil Spec M22759/16-22) (5 A max at 100 C)
- Tefzel wire is difficult to strip unless the correct stripping tool is used.
- Be careful not to nick the wires as this may result in wire failure or poor crimping.

- Some sensor connectors may not be available with 22# terminals, in which case doubling the wire over gives the equivalent of an 18# wire. This is suitable for many of the common sensor terminals.
- Use the correct crimping tool for all contacts to ensure a reliable connection.
- Power the Display Logger via a separate switch and a 5 ampere fuse, to ensure the PC can communicate with the Display Logger without the need to power the rest of the vehicle.
- The C127 ground must have a direct connection to the vehicle battery.
- The Display Logger is connected to other devices via the CAN bus.

Connecting Devices

Peripheral devices can be directly connected to the Display Logger's input and output pins. The Display Logger can also send or receive data from other devices via either RS232 or CAN communications.

Inputs – Requires I/O Upgrade

Input Types

A range of sensors is available to suit different types of measurement, e.g. temperatures, pressures, speed. Each type of measurement generates a different electrical signal that requires a suitable input type.

Each sensor needs to be connected to the type of input designed to suit that type of sensor.

MoTeC devices have the following input types available:

- Analogue Voltage Inputs
- Analogue Temperature Inputs
- Digital Inputs
- Wheel Speed Inputs

In addition to sensors connected to the inputs, the Display Logger has internal sensors available for battery voltage, device temperature and G-force.

Analogue Voltage Inputs

Analogue Voltage inputs are normally used to measure the signals from analogue voltage type sensors, i.e. sensors with variable voltage outputs, such as:

- Rotary or linear potentiometers

- Signal conditioned three-wire pressure sensors
- Thermocouple amplifiers
- Accelerometers

These inputs can also be used to measure two-wire variable resistance sensors if an external pull-up resistor is connected from the input to the 5 V sensor supply.

Additionally, on/off switch signals may be connected, which may also require an external pull-up resistor.

Analogue Temp Inputs

Analogue Temperature inputs are identical to Analogue Voltage inputs, except that they contain a 1000 ohm resistor which is connected internally from the input pin to the 5 V sensor supply. This allows the Analogue Temperature inputs to be used with two-wire variable resistance sensors, such as:

- Two wire thermistor temperature sensors
- Two wire variable resistance pressure sensors

Some voltage output sensors can also be used if they can drive the 1000 ohm resistor without causing an error in their reading (e.g. MoTeC Thermocouple Amplifier).

Additionally, on/off switch signals may be connected.

Digital Inputs

Digital inputs can be used for the external switches required to operate the display. These inputs have a 4700 ohm resistor connected internally from the input pin to the 5 V sensor supply so that a switch can be simply connected between the input pin and 0 V.

They can also be connected to a brake switch or other switch.

Digital Inputs include the following measurement methods:

- Frequency: The frequency of the input signal is measured
- Period: The time between successive pulses is measured
- Pulse width: The low time of the pulse is measured
- Count: Counts the number of pulses
- Phase Difference: Calculates the phase difference between two digital inputs
- Beacon: For connection of a lap beacon

Speed Inputs

Speed Inputs are identical to Digital Inputs except that they can also be configured to suit Variable Reluctance (Magnetic) sensors, such as some wheel speed sensors. Because the amplitude of the signal from these sensors changes with speed of rotation, variable trigger levels are required, which must vary with the frequency of the input signal.

The Speed Inputs can also be used with Hall Effect type wheel speed sensors.

The Pulse Width method measures the high time of the pulse rather than the low time as measured by the Digital Inputs.

Input Specifications

For full specifications see [Input Characteristics](#).

Expanders

If additional sensors are required, input expanders can be used, such as MoTeC's E816 and E888. Sensors can be connected to the expander inputs and communicate via either RS232 or CAN. See [Configuring Communications](#).

Outputs – Requires I/O Upgrade

Auxiliary Outputs are used to control various vehicle functions, for example:

- Gear Change Lights
- Warning Lights
- Relays controlling Thematic Fans and Pumps etc.

Note: Devices that consume more than the maximum current (e.g. motors) should be driven via a relay or a MoTeC PDM (Power Distribution Module).

Output Specifications

Full specifications can be found in [Output Characteristics](#).

Expanders

If additional outputs are required, output expanders can be used, e.g. PDM. Expander outputs can perform the same tasks as the device outputs and can be driven by communication via either RS232 or CAN. See [Configuring Communications](#).

Communications

Communications are used to send and receive data from one device to another. There are two communication protocols: RS232 and CAN. Generally older devices use RS232 and newer devices use CAN.

CAN (Controller Area Network) Communications

This protocol enables communication between all devices connected to the same bus. The CAN bus allows for communicating at high speeds. The C127 has two independent CAN communications ports that can be connected to other devices with a compatible CAN port. The bus speed for each interface can be set independently.

Typical MoTeC devices communicating over CAN:

- M84 and 'Hundred Series' ECUs: M400, M600, M800, M880
- Shift Light Module: SLM
- Lambda meters: LTCs, PLM
- Expanders and input modules: E888, PDM
- Displays: SDL3
- Beacon receiver: BR2

These devices communicate at 1 Mbit/sec, so any other devices connected on the CAN bus must also communicate at 1 Mbit/sec. If a device communicates at another speed, it should be wired to the other CAN bus, and the speed of that CAN bus must be set to match the speed of the device.

RS232 Serial Communications

This is a one to one protocol, communicating from one device to one other device. Typical devices communicating over RS232:

- MoTeC M4, M48 ECUs
- Radio telemetry device
- Global positioning system: GPS

Note: The Display Logger can only communicate with devices for which it has the appropriate communications protocol defined.

Connecting Devices Examples

Device	Connect via	Remarks
Sensors	Inputs: The appropriate input type depends on the sensor type	MoTeC supplies datasheets with wiring details for all sensors via the website
External Buttons for: - Display mode - Display next line (and optional previous line) - Alarm acknowledge - Lap number reset	Inputs: Digital or Speed inputs	Wire between Display Logger input and Display Logger 0 V. If wired to an Analogue Voltage input, connect an external pull-up resistor between the input pin and the 5 V sensor supply.
External LED Lights	Outputs: Auxiliary output	Wire between one of the Auxiliary Outputs and battery positive and include a current limiting resistor.
SLM Shift Light Module	Communications: CAN	
K-type Thermocouples	Inputs: Analogue Voltage or Analogue Temperature input	Connect via TCA (Thermo Couple Amplifier)
	Communications: CAN	Connect via E888
ECU M4, M48, M8	Communications: RS232	Uses the Telemetry feature of the ECU to send data to the Display Logger
ECU M84, 'Hundred Series': M400, M600, M800, M880	Communications: CAN	Ensure the ECU and Display Logger are connected on the same CAN bus

Software Installation

This section provides information on Dash Manager software, and *i2* Data Analysis software.

It will also explain how to connect the Display Logger to the PC.

PC Recommendations

MoTeC recommends a dedicated laptop for your race car with the following specifications:

- Windows XP, Vista or Windows 7, Windows 8
- Screen size: 1024 x 768
- Processor speed: 1-2 GHz Pentium
- 2 GB RAM
- 256 MB graphics card
- 2 USB ports
- Ethernet port

Most current laptops will meet the specifications above and this will ensure all MoTeC software will run on it.

C127 Dash Manager Software

C127 Dash Manager software is used for configuration, testing, retrieving the logged data, and for general management of the Club Display Logger.

C127 Dash Manager supports configuration of the following connected devices: E816, E888, SLM.

Installing Dash Manager Software

1. Go to the MoTeC website at www.motec.com and navigate to software/latestreleases/C127 Dash Manager software
OR
Locate the Dash Manager software on the MoTeC Resource Disc
2. Save the selected file in your preferred location (for example desktop)
3. When downloading is finished, double click on the file and select run
4. Follow the instructions on the InstallShield Wizard
5. To start the program after installation, click the C127 Dash Manager icon on the desktop or click **Start > All Programs > MoTeC > C127 > C127 Dash Manager**

Updating C127 Dash Manager Software

Software updates are available free of charge, giving access to the latest features. Download the latest software version from the website and follow the software installation instructions to update to the new version.

To update the associated firmware in the device, select **Upgrade Dash Version** from the **Online** menu. See [Configuration Versions and Updating](#).

i2 Data Analysis Software

MoTeC's *i2* data analysis software is used to analyse the logged data that has been recorded by the Display Logger. Any number and combination of graphs, gauges and reports can be analysed simultaneously. The *i2* environment can be customised to specific user requirements.

i2 Standard is included with any Data Logging upgrade.

Connecting the Display Logger to a PC

The Display Logger connects to the Ethernet port on the PC. This requires a connector for the standard Ethernet cable in the loom.

The C125 RACE LOOM TERMINATED #62204 incorporates this connector. Alternatively the connector can be wired into an existing loom using the unterminated Ethernet cable (#61131), or the Ethernet to Superseal Connector Cable that is terminated with Tyco connector pins (#61236).

All options are used in conjunction with a standard Ethernet cable.

Connection details are described in [PC Connection](#)

PC Communications Setup

To enable PC communications, a connection must be setup in the Dash Manager software to match the Display Logger serial number.

- On the **Tools** menu click **Connection Settings** and then click **Add**
- Click **OK** to choose **IP (Ethernet)**. This is the only available connection type.
- Click **Search***
- In the list with discovered devices, click the required Display Logger and click **Select**

If the PC needs to communicate with more than one Display Logger, repeat the steps.

** The connection uses IPV6, which can be affected by firewall and anti virus applications.*

If you have a Display Logger connected but it is not listed in Discovered Devices, try disabling or uninstalling all anti-virus software.

If the Device is 'discovered' without the anti-virus software, you can turn it back on and put in appropriate exceptions to allow the Display Logger Manager to communicate with the device.

Only one connection can be active at a time. To switch to a different Display Logger, click **Make Active**.

Tip: The current connection is listed at the bottom of the Dash Manager splash screen (this is the main Dash Manager screen with the picture of the Logger)

For a quick way to switch between connections

- In the Dash Manager splash screen, enter the connection number (to enter the splash screen, close all other windows in Dash Manager).

Configuration

All aspects of the Display Logger can be configured, including; which sensor is connected to which input, the calibration of each sensor, what to display and where to display it, what to log and how fast to log it, tachometer range, warning alarms, multi stage shift lights etc.

The configuration is stored in a file on the PC. When starting Dash Manager software, the menu items related to changing the configuration are unavailable. To make them available, load a configuration file either by opening an existing file or by creating a new one.

All changes to the Display Logger configuration are performed 'Offline', i.e. without the PC communicating with the Display Logger. The changes are saved in the configuration file on the PC. The file must be sent to the Display Logger before the changes take effect. See [Sending and Retrieving Configuration Files](#).

Tip: When using a laptop in and around a car, it is often not practical to use a mouse to navigate through the program. Using the keyboard to select options is easier. An overview is given in [Windows Keyboard Shortcuts](#).

Configuration Sequence

The configuration is best setup in the following order:

1. Connections (Input Pins & Communications)
2. Calculations (Lap Time, Fuel Prediction etc.)
3. Functions (Logging, Display, Alarms, Auxiliary Outputs etc.)

This simplifies the setup procedure by ensuring that the required channels are available for the functions that use them.

Channels cannot be used until they have been generated by an input, calculation or function.

Configuration File

From the **File** menu the following options are available:

- **New** – creates a new configuration based on a predefined template
- **Open** – selects an existing file
Right-click the configuration file to Rename, Delete, Send to a disk etc.
- **Save** – saves a newly created configuration with a meaningful name
- **Save as** – can be used to create a copy of an existing configuration file by giving it a new name

- **Edit Details** – allows for entering event, venue and vehicle details to be stored with the configuration file
- **Check Channels** – verifies that all channels are correctly generated
- **Edit Configuration Comments** – allows for other comments to be stored with the configuration file
- **View Configuration Summary** – gives a quick overview of the configuration file
- **Convert Logging Image** – allows users to manually convert a log file for use in *i2*
- **Exit** – exits the program

Tip: The most recently used files appear at the bottom of the File menu. This is often the easiest way to open an existing file.

Backups

Whenever a file is saved, the previous content of the file is saved in the *Save Backups* directory. The total number of files is limited to 100.

Channels

Channels are used to convey information between the various systems of the Display Logger.

For example an input pin may feed a channel called 'Fuel Pressure'. This channel may then be used by another system, such as the Display System or Data Logging systems.

The Display Logger channel scheme allows complete flexibility in channel usage, as any available channel can be used by any other function, i.e. any channel can be logged, displayed, used in conditions, used in alarms, used as an input to the user definable tables, etc.

All systems within the Display Logger that generate values must feed one of the channels.

Pre-defined Channels

MoTeC has defined an extensive list of channels.

General Purpose Channels

Since the use of all channels cannot be predetermined, a number of general purpose channels have been included for occasions when a suitable predefined channel is not available.

These general purpose channels may be required when measuring an uncommon value, or when a general purpose function needs to generate a special output channel. For example, a 3D table may generate an output channel to control a valve of some sort, in which case a general purpose channel may be used and named appropriately.

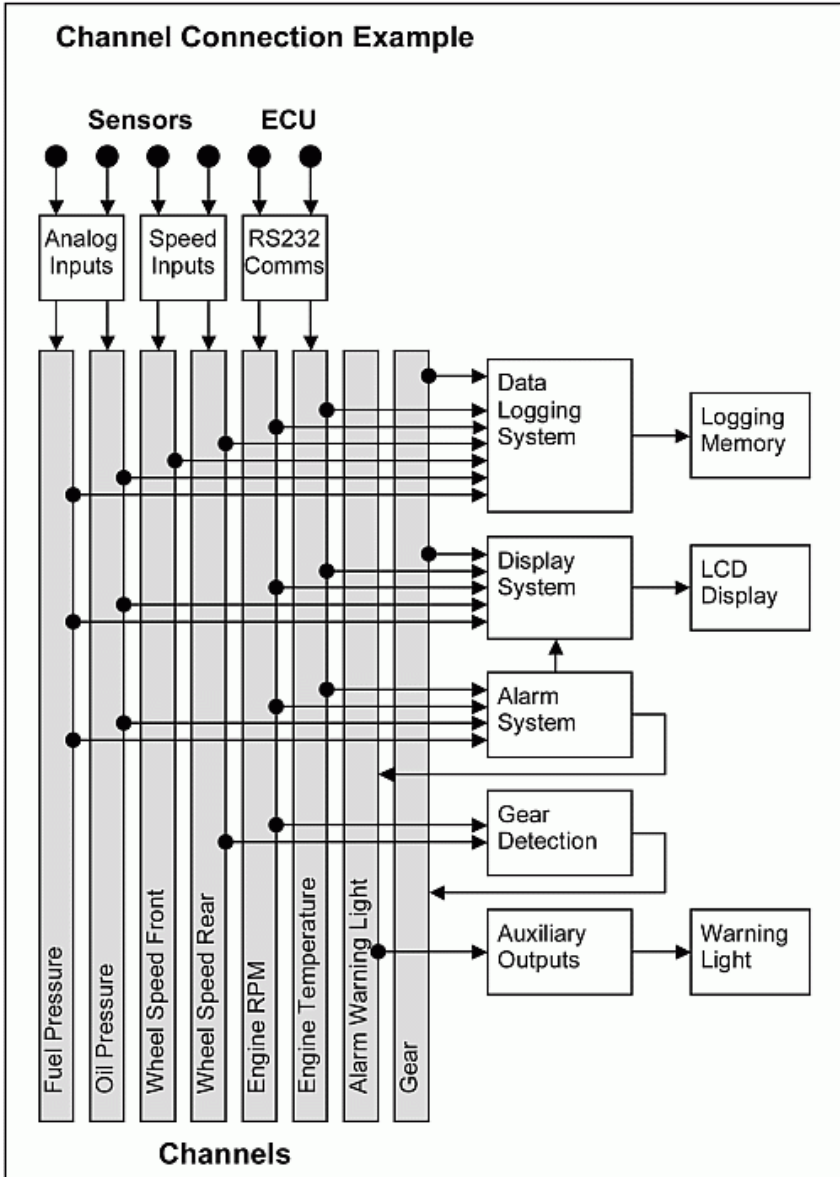

Channel Properties

Each channel has defined properties, some of which may be modified by the user. Predefining these properties makes the channels easy to use throughout the rest of the software.

- Properties that may be modified by the user
 - Name
The channel names (and abbreviations) may be changed if necessary. However name changes should be limited to name preferences rather than redefining the purpose of the channel, except for the general purpose channels which may be renamed to suit the current use.
 - Abbreviation
 - Units (e.g. degrees Celsius, degrees Fahrenheit)
The units for a channel can be selected from a predefined list, for example the Engine Temperature channel may have units of degrees Celsius, Fahrenheit or Kelvin. Conversion between units is automatically handled by the software.
Note: The units are used for display purposes only. This means that the units can be changed at any time without affecting the calibration of the channel.
- Fixed properties
 - Measurement type (e.g. Temperature)
Defining the measurement type allows the channels to be displayed in any unit suitable for that type, with automatic conversion between the units. For example all temperature channels can be displayed in degrees Celsius, Fahrenheit or Kelvin.
 - Resolution
The resolution of all channels is fixed, for example the resolution of the Engine Temperature channel is fixed at 0.1 °C.
Fixed channel resolutions ensure that the unit conversion system works properly and that channel comparisons can be performed correctly.
 - Suitable logging rates
 - Suitable display filtering
 - Minimum and maximum range

Selecting Channels

There are two methods of selecting channels, either the Category Method or the Search Method.

Category Method

This method divides all the channels into categories and sub categories, so that the list can be narrowed down to a small list of channels. For example, the 'Engine Sensors / Cooling' category shows a list of channels associated with the cooling system of the engine.

When selecting a channel from the complete list of channels, it is usually easiest to use the category selection method, for example when assigning a channel to an input pin.

To expand a category

- click on the plus sign (+) next to the category name.

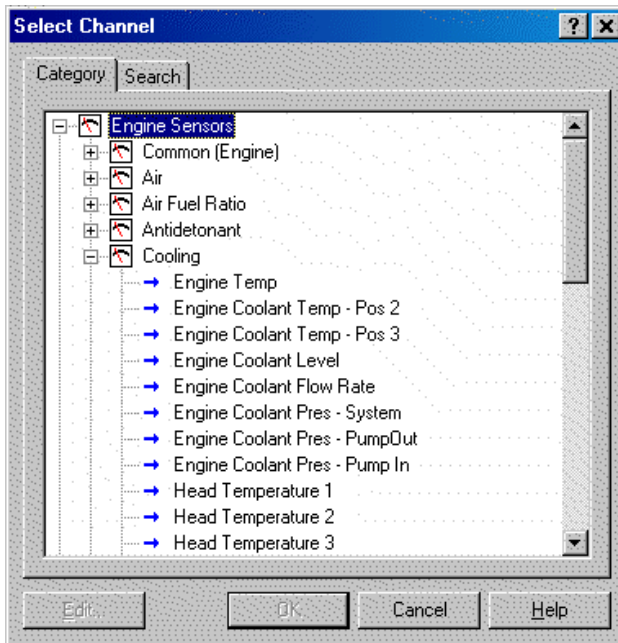

Search Method

This method lists all channels in alphabetical order and allows a channel to be found either by typing the first few letters of any word in the channel name, or by scrolling through the list.

Note: The words may be typed out of order so that 'Engine Oil Temp' could be found by typing "temp eng oil" or "oil t eng" or "e o t"

This method is most useful when selecting a channel from the available channels.

For example, if 'Engine Temperature' has been assigned to an input pin, it can be easily located in the Search list, since this list normally only contains 50 to 100 items.

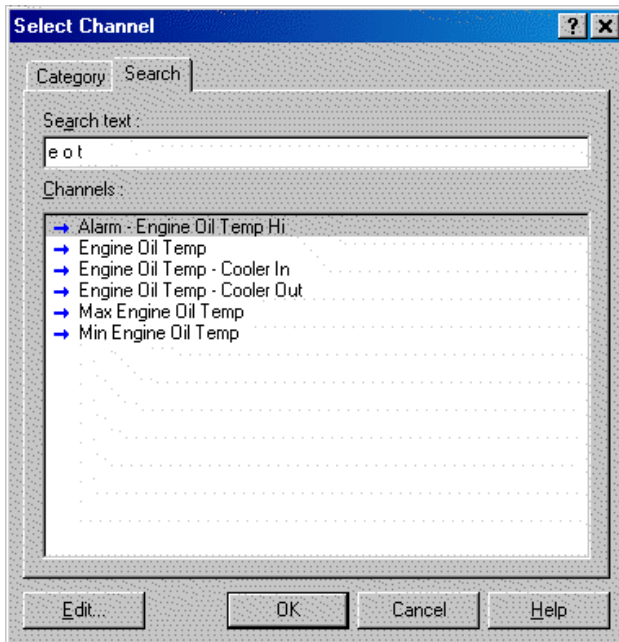

Connections

Configuring Inputs (optional)

On the Connections menu, click Devices

Select the device (e.g. C127) and then click the Input Pins tab

This will list all inputs available for this product

Select the input and click Channel (or double-click the input)

Assign a measurement channel to the input and click OK

The channel needs to be calibrated using one of two options:

Select Load Cal if a pre-defined calibration is available

OR

Double-click the input to enter a calibration

Other tasks:

- **Change Cal** – to change the calibration
- **Spd Levels** – only for speed inputs
- **Settings** – to set default

Configuring Outputs (optional)

1. On the **Connections menu**, click **Devices**
2. Select device (e.g. C127) and then click the **Output Pins** tab to list all outputs available for this product
3. Select the output and click **Change** (or double-click the output)
4. Select a mode to make appropriate settings available
5. Follow the directions on the screen and when all settings are done click **OK**

Configuring Communications

1. On the **Connections menu**, click **Communications**
2. Select an available communications section (CAN or RS232)
3. Click **Select** and choose one of the available communications templates

Comms templates

Communication templates are available for most connected MoTeC devices. When MoTeC releases new products, new communication templates will also be released. These will be incorporated in the latest software versions. See

[Updating C127 Dash Manager Software](#) on how to update to a new software version to make the latest communication templates available.

Calculations

The Display Logger has special and user definable general purpose calculations available. They are set up from the *Calculations* menu.

Special Calculations

- **Lap Time and Number** – click on the tabs to set up Lap Time, Lap Speed, Running Lap Time, Split Lap Times, Lap Number, Laps Remaining
- **Speed and Distance** – click on the tabs to set up Ground Speed, Drive Speed, Wheel Slip, Lap Distance, Trip Distance, Odometer
- **Lap Gain/Loss** – to set up a continuous indication of how far behind or ahead the vehicle is compared to a reference lap
- **Gear Detection** – to set up Current Gear
- **Fuel Prediction** – click on the tabs to set up Fuel Used, Fuel Usage, Fuel Remaining, Laps Remaining, Fuel Used per Lap
- **Speed Min/Max** – to perform Min/Max Speed calculation (Peak/Trough detection)

General Purpose Calculations

- **Tables** – to set up 2D and 3D Lookup Tables
- **User Conditions** – to activate items such as a Thematic Fan or Gearbox Oil Pump
- **Counters** – Set up to 10 counters. Counter value can be increment or decremented based on the selected channel conditions.

Functions

Data Logging (optional)

Data logging allows sensor readings and calculated values to be stored in the Display Logger's memory for later analysis using the *i2* Data Analysis software.

To configure logging

- On the **Functions** menu, click **Logging**
- Select the relevant tabs to set up the logging parameters

Power

The Display Logger power can be turned off at any time without losing the logged data, because it uses FLASH memory that does not require an internal battery to keep it alive.

Logging Memory

The C127 has optional Data Logging upgrades providing 120 MB of logging memory. See [Display Logger Upgrades](#).

Start and Stop Logging Conditions

To avoid logging unnecessary data, logging can be started and stopped by user definable conditions.

For example logging might start when the vehicle exceeds 50 km/h, and stop when the engine RPM is below 500 rpm for 10 seconds.

The Display Logger provides the normal logging type; this will continuously log data to memory whenever the Start Condition is true and the Stop Condition is false.

Memory Usage

When the logging memory is full the Display Logger may be configured to either stop logging, or to overwrite the oldest data, which ensures that the most recent data is always available. This is referred to as cyclic logging.

For most applications it is recommended that cyclic logging is used.

Logging Time

The maximum logging time is dependent on the logging memory size, the number of items logged and the rate at which they are logged. The Dash Manager software will report the total available logging time.

Logging Setup Files

The logging list can be saved and loaded from a file. This allows multiple logging setups to be used.

Logging Rate

The logging rate sets how often each channel is logged and can be set individually for each channel.

The rate at which the values are logged must be fast enough to record all variations in the reading. If the value is logged too slowly, the readings can be totally meaningless. For example, suspension position may need to be logged at 200 times per second or more.

However, if a value is logged faster than necessary it will not improve the accuracy of the logged data. It will just reduce the total logging time available. For example, the engine temperature only needs to be logged at once per second.

CAN Bus Bandwidth Limit

High logging rates also increase the amount of data that is being received from the measurement devices, which increases the amount of data on the CAN bus. This can lead to exceeding the CAN bus bandwidth limit. See [CAN Bus Bandwidth Limit](#).

Note: The Dash Manager software will warn if the bandwidth is likely to be exceeded.

Maximum Logging Rate

The maximum logging rate is limited to the update rate of the particular channel. This varies significantly depending on the source of the channel. For example, some communications devices may only update at 50 Hz. Also some internal calculations may be limited to 100 Hz.

Update Rate

Each input is measured at a maximum rate which is dependent on the capabilities of the measuring device and may also vary between inputs on that device. See [Update Rate Summary](#).

Anti-Alias Filter

If a channel is logged at a rate slower than its specified update rate then an optional anti-alias filter can be applied.

The anti-alias filter is used to average out any variations in the signal between logged values. This ensures that unrepresentative values are not logged.

The anti-alias filter is implemented by averaging the channel values between logging events. For example, if a channel has an update rate of 1000 Hz and it is logged at 100 Hz then the preceding 10 samples will be averaged each time it is logged.

The anti-alias filter is normally turned on by default when a channel is added to the logging list, but may be turned off if required. For normal purposes it is recommended that the anti-alias filter is left turned on.

Note: For some channels the anti-alias filter cannot be turned on because the averaging performed by the filter would cause incorrect values. This is the case for on/off channels and channels where the bit values have a particular meaning, for example error group channels.

Real Time Value (ADL2, SDL)

For channels that come from an ADL2 or an SDL, the logging anti-alias filter also affects the real-time value of the channel. This is the value that all other parts of the system see, such as the various calculations.

Note: The anti-alias filter is limited to 50 Hz for real time values even if the channel is logged at a lower rate. For example, a channel logged at 10 Hz will be filtered and updated at 10 Hz in the logging and 50 Hz for the real time value.

Note: Channels that are not logged are updated at 50 Hz.

Real Time Value (For devices other than ADL2, SDL)

The real time value from other devices and from internal calculations is not anti-aliased at the logging rate, however the value can be anti-aliased in the logging.

Phase Shift

The anti-alias filter will cause a phase shift (time delay) of half the logging rate. For example, a channel logged at 100 Hz is logged every 10 milliseconds, so it is delayed by 5 milliseconds.

For most purposes this time delay is not an issue.

Channels logged at the same rate are delayed by the same amount, which negates this effect when comparing these channels.

This applies to all channels whether they are generated internally from a calculation or whether they are generated externally from devices such as a display device.

Track Map

For the *i2* Data Analysis software to plot a track map, either a GPS should be connected or a number of separate sensors that will provide the required information.

Track Map using GPS

Ensure GPS Latitude and GPS Longitude are logged.

Track Map using Sensors

The following sensors are required and must be logged:

- Lateral G force (internal sensor)
- Wheel Speed
- Lap Beacon (the 'Beacon' Channel must be logged)
- Optionally Longitudinal G force (internal sensor)
A Longitudinal G force sensor should be used if the vehicle has only one wheel speed sensor. This allows the analysis software to eliminate wheel lockups which is essential when creating or using a track map.

Display Using Fixed Layouts

The C127 display is a high contrast, high brightness colour LCD display.

To configure fixed displays

1. On the **Functions** menu, click **Display**.
2. Select the relevant Display type
3. Select the required mode (RACE, PRACTICE, WARMUP) by selecting the relevant tab.
4. Select the required fixed display style by double-clicking on the fixed display style displayed down the left side of the Edit Display Style screen. On the right-hand side are controls to set the colour scheme of the selected style.
5. Set the labels and channels you want to display for each of the numeric display components (e.g. Number 1, Number 2, Gauge, Bar 1 etc.). To do this:
 - a. Select the display component.
 - b. Select the **Change** button (alternatively, double click on the relevant display component).

The screenshot shows the 'Display Setup' window with the 'RACE' mode selected. The 'Channels' tab is active, showing a preview of the display layout and configuration options for various components.

Display Setup

RACE PRACTICE WARMUP Channels Backlight Display Creator Channels Display Creator Settings

Page Label : RACE

Display Style : Edit...

Number 1 : Ground Speed (km/h) <99999>

Number 2 : Engine Temp (C) <99999>

Number 3 : Running Lap Time (M:SS.HH) <59.99>
Lap Time (M:SS.HH) <59.99>

Gauge : Engine RPM 0 to 8000, Shift 7500

Gear : Gear <9>

Bar 1 :

Bar 2 :

Bottom: (4/20 used)

1: Fuel Pres (kPa)	Eng Oil Temp (C)	Eng Oil Pres (kPa)	<9999_999_9999>
2: Bat Volts C185 (V)	Throttle Pos (angle%)	Manifold Pres (kPa)	<999_9_99_9_9999>
3: Lambda 1 (LA)	Lambda 2 (LA)	Air Temp Inlet (C)	<99_99_9_99_9999>
4: Lap Number	Reference Lap Time (M:SS.HH)	<9999_59.99>	
5:			
1:			
2:			

Change... Clear ↑ ↓ Copy From... Options... OK Cancel Help

Display Modes (Pages)

The display has three display modes or pages; the default names are RACE, PRACTICE and WARMUP. The mode is changed by pressing the button assigned to this function.

The mode names can be changed to suit your individual needs; this is done by double-clicking on the **Page Label** field.

RACE Page

The Race display is normally used to display minimal information, e.g. RPM, Lap Time, Fuel Remaining or Laps Remaining.

PRACTICE Page

The Practice display is normally used to display basic information, plus information to help the driver improve lap times, e.g. Lap Time, Lap Gain/Loss, Maximum Straight Speed, Minimum Corner Speed or Corner Exit Speed.

WARMUP Page

The Warm-up display is normally used to display important engine sensor readings during engine warm-up, e.g. RPM, Battery Voltage, Engine Temperature, Oil Pressure, Oil Temperature and Fuel Pressure.

Bar 1 and Bar 2

The Bar 1 and Bar 2 facility provides the means to configure two bar type graphs. One could most likely be configured to graphically represent the current value of the Lap Gain/Loss Running channel as a Gain / Loss bar, the other can be configured as any other useful indicator such as a battery voltage, fuel, temperature or pressure gauge.

Two intermediate points can be set, see the battery voltage example below. However, a gain/loss bar can only use the first intermediate point.

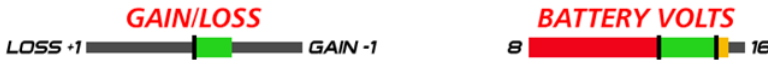

Example Bar 1 (gain / loss bar) and Bar 2 (battery voltage gauge)

These bars can be customised to suit a user's preference. The properties for these two examples are shown below.

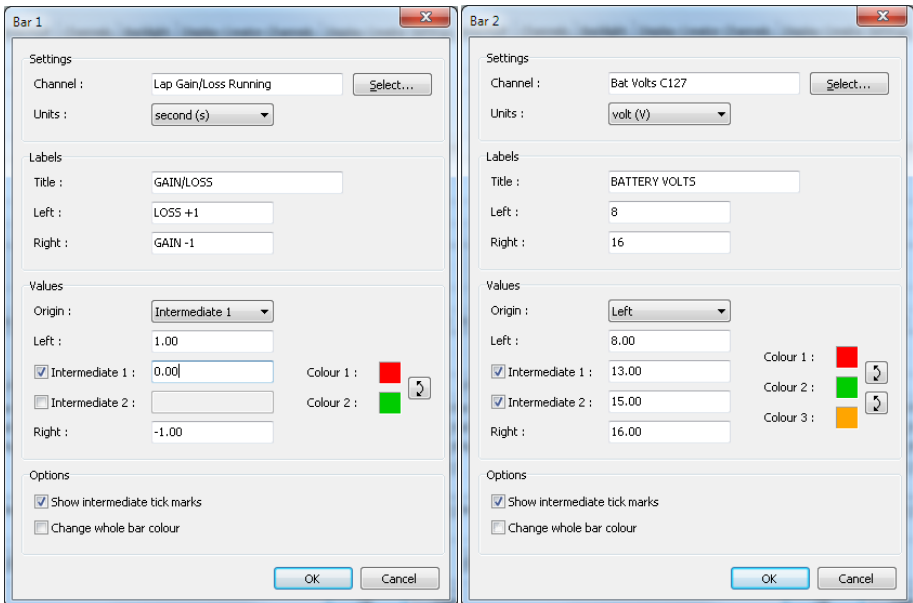

In the battery volts example, with the Change whole bar colour option not selected, the three specific colours will display in the relative section of the bar according to the channel value, as shown in the example.

If the Change whole bar colour option is selected, the **whole** bar colour will be red if the channel value is from 8 to 13, green from 13 to 15 and red from 15 to 16.

The bars can be customised to suit a user's preference. For example:

- Setting the scale and the time units.
- Customise the labels at either end of the bar. In the GAIN/LOSS example above, LOSS +1 and GAIN -1 are used, where 1 is the scaling value. Another label example could be LEFT and RIGHT.
- Invert colours.
- Specify the negative to the left or right.

Dial or Bar Graph (depending on style chosen)



Example dial

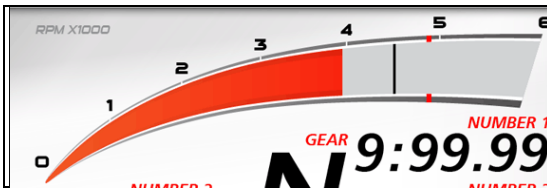

Example sweep bar

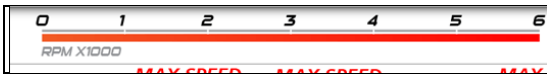

Example linear bar

The dial or bar graph has a user definable range and is typically used as a tacho, however it can be used to display any other value.

A fully programmable shift point can be displayed, which can also be gear dependent.

Top Displays

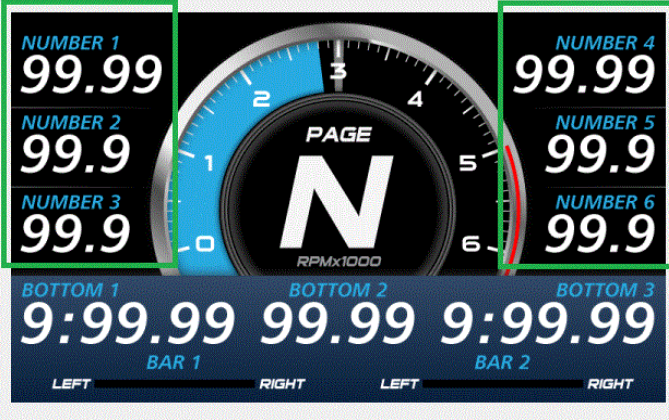

The numeric displays can be programmed to display any channel value. The numeric displays can show any channel value plus up to two override values. Override values display each time their value is updated. This is useful for values that are updated periodically. The override values are shown for a programmable period of time. For example, a numeric display could normally show the Running Lap Time (which is continuously updating), then be overwritten by the Lap Time for 10 seconds each time the Lap Time is updated.

The label above each of the numeric displays can be changed to suit the channel assigned.

Centre Display

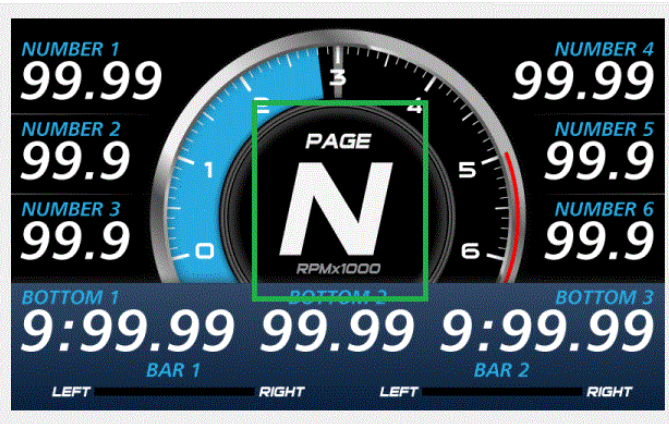

The centre display is normally used to display the current gear but can be used for other purposes.

Bottom Display

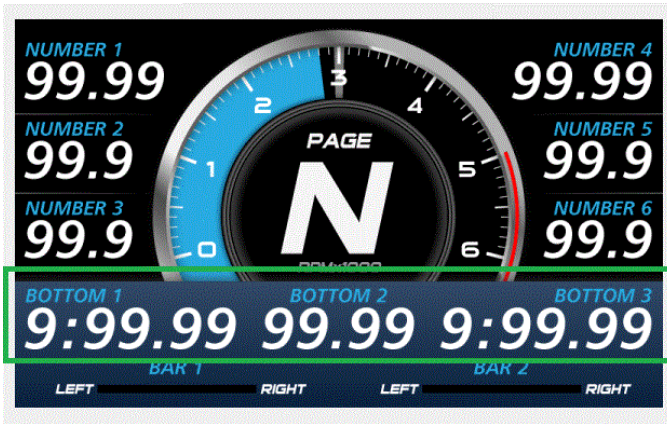

At the bottom, up to 20 lines can be accommodated, with each line containing up to 3 channel values at a time.

The label above each value can be changed to suit the channel assigned.

The 20 lines can be scrolled up or down using external buttons.

Similar to the top numeric displays, the bottom display can show up to four override values.

Four Line Style

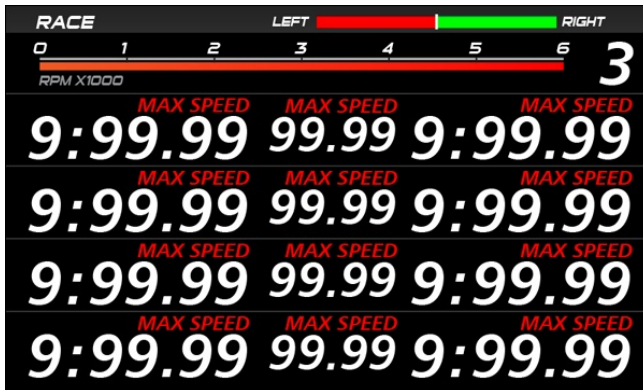

Where the four-line style is chosen, it shows four lines of values at a time, with up to three values per line.

The 20 lines can be scrolled up or down, 4 lines at a time, using external buttons.

Alarm Displays

When an alarm is activated, a message is shown along the bottom of the display until it is acknowledged. To draw the driver's attention to the display, it is recommended to activate a warning light.

The message can be defined as required and can include the current sensor reading or the sensor reading when the alarm was triggered.



Example active unacknowledged alarm

See the [Alarms](#) section for details on behaviour and operation of alarms.

Up to 6 active acknowledged alarms can be displayed in the Alarm Status Panel along the bottom of the display, covering what was there before. By default, the Alarm Status Panel display is OFF. This can be set ON by the user. See [Alarms](#) for details about the Alarm Status Panel and its operation.

Below are examples of how active acknowledged alarms would be arranged.

<table border="1"> <tbody> <tr> <td>ENGINE TEMP 81</td> <td rowspan="3"> </td> <td>SESSION TIME 0:09</td> </tr> <tr> <td>OIL PRESSURE 430</td> <td>LAP NUMBER 228</td> </tr> <tr> <td>SPEED 121</td> <td>BATTERY 6.8</td> </tr> <tr> <td>RUNNING LAP TIME 0:05.3</td> <td>GAIN/LOSS 0.00</td> <td>LAST LAP TIME 0:00.00</td> </tr> <tr> <td colspan="3">WARNINGALARM 1.2345</td> </tr> <tr> <td colspan="3">One Active Alarm</td> </tr> </tbody> </table>	ENGINE TEMP 81		SESSION TIME 0:09	OIL PRESSURE 430	LAP NUMBER 228	SPEED 121	BATTERY 6.8	RUNNING LAP TIME 0:05.3	GAIN/LOSS 0.00	LAST LAP TIME 0:00.00	WARNINGALARM 1.2345			One Active Alarm			<table border="1"> <tbody> <tr> <td>ENGINE TEMP 81</td> <td rowspan="3"> </td> <td>SESSION TIME 0:09</td> </tr> <tr> <td>OIL PRESSURE 430</td> <td>LAP NUMBER 228</td> </tr> <tr> <td>SPEED 121</td> <td>BATTERY 6.8</td> </tr> <tr> <td>RUNNING LAP TIME 0:05.3</td> <td>GAIN/LOSS 0.00</td> <td>LAST LAP TIME 0:00.00</td> </tr> <tr> <td colspan="3">WARNINGALARM 1.2345 WARNINGALARM 1.2345</td> </tr> <tr> <td colspan="3">Two Active Alarms</td> </tr> </tbody> </table>	ENGINE TEMP 81		SESSION TIME 0:09	OIL PRESSURE 430	LAP NUMBER 228	SPEED 121	BATTERY 6.8	RUNNING LAP TIME 0:05.3	GAIN/LOSS 0.00	LAST LAP TIME 0:00.00	WARNINGALARM 1.2345 WARNINGALARM 1.2345			Two Active Alarms		
ENGINE TEMP 81			SESSION TIME 0:09																														
OIL PRESSURE 430			LAP NUMBER 228																														
SPEED 121		BATTERY 6.8																															
RUNNING LAP TIME 0:05.3	GAIN/LOSS 0.00	LAST LAP TIME 0:00.00																															
WARNINGALARM 1.2345																																	
One Active Alarm																																	
ENGINE TEMP 81		SESSION TIME 0:09																															
OIL PRESSURE 430		LAP NUMBER 228																															
SPEED 121		BATTERY 6.8																															
RUNNING LAP TIME 0:05.3	GAIN/LOSS 0.00	LAST LAP TIME 0:00.00																															
WARNINGALARM 1.2345 WARNINGALARM 1.2345																																	
Two Active Alarms																																	
<table border="1"> <tbody> <tr> <td>ENGINE TEMP 81</td> <td rowspan="3"> </td> <td>SESSION TIME 0:09</td> </tr> <tr> <td>OIL PRESSURE 430</td> <td>LAP NUMBER 228</td> </tr> <tr> <td>SPEED 121</td> <td>BATTERY 6.8</td> </tr> <tr> <td>RUNNING LAP TIME 0:05.3</td> <td>GAIN/LOSS 0.00</td> <td>LAST LAP TIME 0:00.00</td> </tr> <tr> <td colspan="3">WARNINGALARM 1.2345 WARNINGALARM 1.2345 WARNINGALARM 1.2345</td> </tr> <tr> <td colspan="3">Three/Four Active Alarms</td> </tr> </tbody> </table>	ENGINE TEMP 81		SESSION TIME 0:09	OIL PRESSURE 430	LAP NUMBER 228	SPEED 121	BATTERY 6.8	RUNNING LAP TIME 0:05.3	GAIN/LOSS 0.00	LAST LAP TIME 0:00.00	WARNINGALARM 1.2345 WARNINGALARM 1.2345 WARNINGALARM 1.2345			Three/Four Active Alarms			<table border="1"> <tbody> <tr> <td>ENGINE TEMP 81</td> <td rowspan="3"> </td> <td>SESSION TIME 0:09</td> </tr> <tr> <td>OIL PRESSURE 430</td> <td>LAP NUMBER 228</td> </tr> <tr> <td>SPEED 121</td> <td>BATTERY 6.8</td> </tr> <tr> <td>RUNNING LAP TIME 0:05.3</td> <td>GAIN/LOSS 0.00</td> <td>LAST LAP TIME 0:00.00</td> </tr> <tr> <td colspan="3">WARNINGALARM 1.2345 WARNINGALARM 1.2345 WARNINGALARM 1.2345 WARNINGALARM 1.2345</td> </tr> <tr> <td colspan="3">More than Four Active Alarms</td> </tr> </tbody> </table>	ENGINE TEMP 81		SESSION TIME 0:09	OIL PRESSURE 430	LAP NUMBER 228	SPEED 121	BATTERY 6.8	RUNNING LAP TIME 0:05.3	GAIN/LOSS 0.00	LAST LAP TIME 0:00.00	WARNINGALARM 1.2345 WARNINGALARM 1.2345 WARNINGALARM 1.2345 WARNINGALARM 1.2345			More than Four Active Alarms		
ENGINE TEMP 81			SESSION TIME 0:09																														
OIL PRESSURE 430			LAP NUMBER 228																														
SPEED 121		BATTERY 6.8																															
RUNNING LAP TIME 0:05.3	GAIN/LOSS 0.00	LAST LAP TIME 0:00.00																															
WARNINGALARM 1.2345 WARNINGALARM 1.2345 WARNINGALARM 1.2345																																	
Three/Four Active Alarms																																	
ENGINE TEMP 81		SESSION TIME 0:09																															
OIL PRESSURE 430		LAP NUMBER 228																															
SPEED 121		BATTERY 6.8																															
RUNNING LAP TIME 0:05.3	GAIN/LOSS 0.00	LAST LAP TIME 0:00.00																															
WARNINGALARM 1.2345 WARNINGALARM 1.2345 WARNINGALARM 1.2345 WARNINGALARM 1.2345																																	
More than Four Active Alarms																																	

Display Formatting

Units

All display units can be changed to suit the driver preferences, for example, show temperatures in Fahrenheit rather than in Celsius.

Note: This is independent of the units used for other purposes.

Decimal Places

The number of decimal places can be reduced for display purposes, for example, the engine temperature is measured to 0.1 °C but is better displayed with no decimal places.

Display Setup with Display Creator

When using Display Creator, communications and channels need to be set up. To automate this, a DBC file is created when the Dash Manager configuration is saved. This file can then be imported into Display Creator.

The Display Creator Channels and Display Creator Settings tabs are used to set the definitions for creation of the DBC file. This file is then imported into Display Creator to automate the communications and channels setup.

External Displays (Display Creator) with CAN

External displays created with Display Creator use CAN for messaging, the following CAN values must be set:

- The CAN bus
- The address format
- The base address, or select the default.

A warning will display if any of the CAN settings conflict with existing CAN configurations.

Display Creator Channels Tab

This tab is used to select the channels to include in the DBC file. The DBC file is created when the configuration is saved.

The DBC file is imported by Display Creator to automate the setup of communications and channels.

Note: Channels selected in the Display Creator Setting tab (see below) must also be selected in this list for them to be included in the DBC file.

Display Creator Settings Tab

This tab is used to define page display behaviour.

Note: The channels selected on this tab must also be included in the Display Creator Channels list (see above) for them to be included in the DBC file for import to Display Creator.

Number of Pages

Specifies the number of pages defined in the applicable Display Creator configuration.

Preserve Page

If ticked and the device is power cycled, the last page that was displayed for at least five second before the power cycle occurred will display.

If not ticked and the device is power cycled, the default page will display.

Page Channels

Specifies the channels used to set page up, down and reset values.

Page up is the next page in numeric sequence, default channel is *Display Page Up Button*.

Page down is the previous page in numeric sequence; default channel is *Display Page Down Button*.

Page reset returns the display to the default page; default channel is *Display Page Reset Button*.

Output Channels

This is used to select the output channel, which is the channel that controls the page displayed; default channel is *Display Page*.

Note: For page control to function, this channel should be included in the Display Creator Channels list so that it is included in the DBC file for import to Display Creator.

For example, if the output channel value is 3 (that is page 3 is displayed), it is increased to 4 via the *Display Page Up Button* channel and decreased to 2 via the *Display Page Down Button* channel.

Options Tab

This tab is used to select whether a DBC file should be generated, and if so, its filename.

If the DBC file is to be generated, specify a filename or select the default, The default syntax is: [name of the configuration]-[display name].dbc.

Alarms

Alarm Comparisons

The warning alarm limits are fully programmable and may include up to 6 comparisons to ensure that the alarms are only activated at the correct time. For example, an engine temperature alarm may activate at 95 °C if the ground speed has been above 50 km/h for 30 seconds. The speed comparison avoids the alarm showing during a pit stop due to heat soak. Additionally another comparison could be set at a higher temperature to cover all other situations.

The comparison values can be automatically incremented or (decremented) when an alarm occurs. For example the engine temperature alarm may be set at 95 °C with an increment of 5 °C, so that the second time the alarm activates at 100 °C. A limit may be set on the number of times the comparison value is allowed to increment. An alarm may return to its original value after a period of time, in case the alarm condition was temporary.

The alarms can be dependent on the current display mode page (Warm-up, Practice or Race).

Alarm Behaviour

Alarms are either:

- Active and unacknowledged (alarm conditions are true).
- Inactive and unacknowledged (alarm condition was true but became not true before alarm was acknowledged).
These will continue to display until acknowledged.
- Active and acknowledged (alarm conditions are true but not displayed).
- Inactive (conditions needed to make an alarm active are not met or true).

The following behaviour applies:

- Active and inactive unacknowledged alarms remain displayed until they are acknowledged, either by the Acknowledge Button or automatically after a defined period of time. After acknowledgement, and if the alarm is still active, it may display again after the "do not display message interval" has elapsed.

Note: If it appears that an active unacknowledged alarm cannot be acknowledged (that is, it continues to display), it could be that the "Do not display this message again until ... seconds have elapsed" is set to zero.

- If there is more than one unacknowledged alarm, the alarm with the highest priority (that is, the alarm that is highest on the alarm list) is displayed.
- If there are a number of unacknowledged alarms, these will display in priority sequence as each higher priority alarm is acknowledged.

Alarm Status Panel

Additionally an Alarm Status panel may be displayed which shows the current state of up to 6 active acknowledged alarms. The panel is off by default and may be turned on or off using the Alarm Acknowledge button when there are no alarm messages displayed. If displayed, it will be obscured while there is an unacknowledged alarm.

Below are four examples of the Alarm Status Panel.

<p>0:05.3 0.00 0:00.00</p> <p>WARNINGALARM 1.2345</p> <p>One Active Alarm</p>	<p>0:05.3 0.00 0:00.00</p> <p>WARNINGALARM 1.2345 WARNINGALARM 1.2345</p> <p>Two Active Alarms</p>
<p>0:05.3 0.00 0:00.00</p> <p>WARNINGALARM 1.2345 WARNINGALARM 1.2345 WARNINGALARM 1.2345 WARNINGALARM 1.2345</p> <p>Three/Four Active Alarms</p>	<p>0:05.3 0.00 0:00.00</p> <p>WARNINGALARM 1.2345 WARNINGALARM 1.2345 WARNINGALARM 1.2345 WARNINGALARM 1.2345 WARNINGALARM 1.2345 WARNINGALARM 1.2345</p> <p>More than Four Active Alarms</p>

Other Functions

The Display Logger can perform many other functions accessible from the Functions menu including the following:

Shift Lights – to configure the shift point values for use with the Shift Lights.

Shift Light Module – to configure the C127 16 stage shift lights as well as an additional MoTeC's SLM-C or SLM.

Operation

When operating the C127, any of the activities of the **Online** menu of the Display Logger Manager software can be performed. This requires the PC to communicate to the Display Logger.

Note: All other menu items perform offline activities.

Retrieving the Logged Data

- On the **Online** menu, click **Get Logged Data**

A PC is used to unload the logged data from the Display Logger. The logged data is then stored on the computer's hard disk.

After each unload the user has the option to clear the logging memory.

The unload may be interrupted part way through if necessary by disconnecting the computer. The partial unload will contain the most recently logged data and will be stored on the computer's hard disk. In this case the Display Logger memory is not cleared and logging will continue as normal at the end of the existing data. Next time the logged data is unloaded both the new data and the previously partly unloaded data will be retrieved.

Sending and Retrieving Configuration Files

- On the **Online** menu, click **Send Configuration** to send the currently open configuration file

Note: When a configuration file is sent to the Display Logger the existing data is retrieved and stored in the *From Dash Backups* directory to use in case the data in the Display Logger needs to be restored. The maximum number of files is 10.

- On the **Online** menu, click **Get Configuration** to retrieve the current configuration file.

This will only be necessary if the original file is not available on the PC.

Zeroing Sensors

Some sensors require regular zeroing, for example Steering Angle, Suspension Position, Ride Heights, G Force Sensors and Throttle Position. Dash Manager software provides a feature for easy zeroing of all these sensors.

Checking Operation

Monitor Channels

The currently active channels can be monitored to check the operation of all functions and measurements.

- On the **Online** menu, click **Monitor Channels**
- To show any channel on an oscilloscope style screen, click **Utilities** and then **Oscilloscope**

Simulate

The Simulate feature allows most input channels to be manually changed so that the Display Logger operation can be checked under abnormal conditions, e.g. High Engine Temp. This is extremely useful for checking that the Display Logger is working as expected.

- On the **Online** menu, click **Simulate**

Test

A number of tests are provided to check the operation of the Display Logger, such as the Display test.

- On the **Online** menu click the appropriate test

Configuration Versions and Updating

- On the **Online** menu, click **Upgrade Dash Version**

The software inside the Display Logger (firmware) can be updated by the user at any time to take advantage of the latest features.

Matching Versions

The firmware version must match the version of the Dash Manager software on the PC in order to communicate. Dash Manager will show a warning if the versions do not match.

Tip:

To check the version of Dash Manager, click **About MoTeC C127 Dash Manager** on the **Help** menu.

The firmware version is displayed on the bottom line of the display for two seconds when the Display Logger is powered.

Matching Configuration File

The configuration file must also match the software and firmware versions used. The display will show a warning if the file does not match.

Configuration files can be updated by choosing the option to automatically update the configuration file while updating the software (firmware). It can also be done manually by upgrading the configuration file and sending it to the Display Logger:

- On the **File** menu, click **Open**
- In the **Files of type** box select the new version file extension.
The file will be converted to the new version format and saved with the same file name but with the new version file extension.
Note: The old file is not changed.
- On the **Online** menu, click **Send Configuration** to send the configuration file to the Display Logger

Upgrading the Display Logger

Several options are available as upgrades to customise and grow your system.

The currently enabled options can be listed and new options can be activated through a password acquired from MoTeC.

To Upgrade the Display Logger

- On the **Online** menu, click **Enable Dash Options**

Password Protection

- On the **Online** menu, click **Set Access Passwords**

Several Display Logger capabilities can be protected from unauthorised access by using the password protection.

Note: Ensure you keep passwords secure. The unit needs to be returned to MoTeC for unlocking if the passwords are lost.

Other Online Activities

Many other activities are accessible from the **Online** menu including the following:

Reference Lap – to send a reference lap to the Display Logger used in the lap gain/loss system.

View – to view:

- saved details e.g. **Running Totals**
- **Device Halt Counts**

Communication – to list the current Connections Settings

Miscellaneous

- **Erase Logged Data** without unloading
- **Serial Number** to view the Serial and Hardware Number; the Serial Number is required when ordering upgrade passwords, the Hardware Number is for MoTeC internal use
- **Change Display Mode** to switch between Practice, Warm-up and Race mode

Appendices

Specifications

Specifications listed as optional are available as upgrades to customise and grow your system. These additional features are activated through a simple password system, at any time when you need it.

An overview of the upgrades can be found in [Display Logger Upgrades](#).

Logging

Optional 120 MB logging memory

Logging rates up to 500 samples per second

Fast Ethernet download

Includes i2 Standard data analysis software

Display

Type: 7" colour TFT LCD, anti-reflective

Resolution: 800 x 480, anti-aliased graphics

Layouts: diverse selection of configurable fixed layouts, or purchase Display Creator to create user designed and configured layouts

48 user-defined, scrollable message lines with programmable overrides

3 programmable modes with customisable labels

Inputs – (requires I/O Upgrade Option)

6 x Analogue voltage inputs

- 4 x 0 to 5.46 V, 1.33 mV resolution
- 2 x 0 to 15.0 V, 3.66 mV resolution

2 x Analogue temperature inputs

- 2 x 0 to 15 V, 3.66 mV resolution

2 x Digital inputs (provided, does not require I/O Upgrade)

3 x Speed inputs (provided, does not require I/O Upgrade)

Outputs – (requires I/O Upgrade Option)

4 low side outputs PWM or switched operation

Expanders

Compatible with up to two E888 and E816 expanders (providing full functional use)

Internal Sensors

3-axis accelerometer, detection range: +/- 5G

Dash temperature sensor

Sensor supply voltage

Battery voltage

Communications

2 configurable CAN buses, with individually programmable CAN bus speeds. One can be used as RS232 Receive:

- Maximum data range 1 Mbit/sec
- Recommended terminating impedance 100 ohm
- Configurable as either CAN or RS232

2 RS232 ports, one with transmit and receive, one with receive only

1 LIN port

Power Supply

Operating voltage: 6 to 32 V DC

Operating current: 0.8 ampere typical at 14 V (at full brightness, excluding sensor currents)

Reverse Battery protection

Battery Transient protection

Operating Temperature

Internal: -20 °C to 80 °C (above 60 °C maximum backlight brightness progressively reduced)

Typical ambient temperature range in free air: -20 to 60 °C

Sensor Supply Current

5 V Sensor supply: 0.25 ampere maximum

8 V Sensor supply: 0.25 ampere maximum

Ingress Protection (IP) Rating

IP 67 - Dust tight, protected against water immersion (up to 30 min submersion to depth of at least 15 cm)

Note: IP rating is dependent upon the user ensuring that connector wire entries are waterproof, which as a minimum, requires all unused wire cavities on the connector to be plugged.

Physical

Size: 196.2 x 122.5 x 24.9 mm excluding connector

Weight 615 g

1 x 34 pin waterproof connector

Display Logger Upgrades

For the C127 Display Logger the following upgrades are available:

C127 120 MB Logging (part 29818)

Allows recording of all input data to a 120 MB internal logging memory, includes i2 Standard data analysis software.

C127 Pro Analysis (part 29820)

Upgrade from the i2 Standard version that is supplied as standard with the data logging upgrade.

C127 I/O (part 29800)

Allows use and configuration of extra inputs and outputs consisting of:

6 analogue voltage inputs

2 analogue temperature inputs

4 auxiliary outputs.

C127 Display Creator (part 29816)

Allows the user to create fully configurable custom layouts.

Characteristics

Input Characteristics

Analogue Voltage Inputs

Suitable for	Potentiometers Voltage output sensors Variable resistance sensors with pull-up resistor
Measure Voltage Range	Inputs 1-4: 0 to 5.46 V Inputs 5-6: 0 to 15.00 V Note: Voltages outside this range may affect the readings on other inputs.
Input Resistance	100k ohms to 0 V
Resolution	Inputs: 1.33 mV
Measurement Methods	Ratiometric Absolute Variable Resistance Off/On
Update Rate	1000 times/second
Filter	240 Hz 1st order
Calibration Accuracy	Gain 0.05% max (Ratiometric method) Gain 0.15% max (Absolute method) Offset ± 6 mV max Linearity ± 6 mV max Temperature Stability 60 ppm/ $^{\circ}$ C max Calibration Schedule 12 months

Analogue Temp Inputs

Suitable for	2 wire variable resistance sensors and some voltage output sensors
Measure Voltage Range	0 to 15.0 V Note: Voltages outside this range may affect the readings on other inputs.
Input Resistance	1000 ohms pull-up to 5 V sensor supply +100 k to 0 V
Resolution	3.66 mV
Measurement Methods	Ratiometric Absolute Variable Resistance Off/On
Update Rate	1000 times / second
Filter	290 Hz 1 st order
Calibration Accuracy	Gain: 0.05% max (Ratiometric method) Gain: 0.15% max (Absolute method) Offset: ± 6 mV max Linearity: ± 6 mV max Temperature Stability: 60 ppm/ $^{\circ}$ C max Calibration Schedule: 12 months

Digital Inputs

Suitable for	Switch to 0 V Logic signal and open collector device (e.g. Hall Switch)
Pull-up Resistor	2200 ohms to 3.3 V
Voltage Range	0 to 15 V
Positive Trigger Threshold	2.4 V max
Negative Threshold	0.6 V min
Hysteresis	0.4 V min
Update Rate	100 times / second
Filter Time Constant	22 usec
Measurement Methods	<p>Frequency Resolution 0.1 Hz Maximum Frequency 3200 Hz Rising Edge Triggered</p> <p>Period 1 usec Measures period between rising edges Resolution 1 usec Maximum 32 msec</p> <p>Period 100 usec Measures period between rising edges Resolution 100 usec Maximum 3.2 sec</p> <p>Pulse Width 1 usec Measures pulse low time Resolution 1 usec Maximum 32 msec</p> <p>Pulse Width 100 usec Measures pulse low time Resolution 100 usec Maximum 3.2 sec</p>

Speed Inputs

Hall mode	A 2200 ohm pull-up resistor is connected to 2.7 V
Suitable for	Switch to 0 V Logic signal Open collector device (e.g. Hall Switch)
Pull-up Resistor	2200 ohms to 2.7 V
Voltage Range	0 to 15 V
Trigger Threshold	Selectable between -1.33 V and 4.68 V
Magnetic mode	
	The pull-up resistor is disengaged and the trigger levels can be varied depending on the input frequency
Suitable for	Two wire magnetic sensor (variable reluctance sensor)
Input Resistance	100k ohms to ground (no pull-up)
Voltage Range	-80 V to +80 V
Programmable Trigger Levels	-1.33 V to 4.68 V
For both modes	
Update Rate	100 times / second
Filter Time Constant	25 usec
Hysteresis	0.17 V min
Measurement Methods	<p>Frequency Resolution 0.1 Hz Maximum Frequency 3200 Hz Falling Edge Triggered</p> <p>Period 1 usec Measures period between falling edges Resolution 1 usec Maximum 32 msec</p>

	<p>Period 100 usec Measures period between falling edges Resolution 100 usec Maximum 3.2 sec</p> <p>Pulse Width 1 usec Measures pulse high time Resolution 1 usec Maximum 32 msec</p> <p>Pulse Width 100 usec Measures pulse high time Resolution 100 usec Maximum 3.2 sec</p>
--	---

Analogue Input Sampling

4 times oversampling is scheduled with samples taken every 250 usec, providing measurements every 1 msec.

The following inputs are sampled at 250 usec, with microsecond offsets as shown in the table:

Offsets	0.0 usec	+1.5 usec
0.0 usec	AT1	AV1
+9.3 usec	AT2	AV2
+20.9 usec	N/A	AV3
+30.1 usec	N/A	AV4
+39.4 usec	N/A	AV5
+51.0 usec	N/A	AV6
+81.1 usec	N/A	INTTEMP
+90.4 usec	8VSEN	SPD1
+102.0 usec	5VSEN	SPD2
+111.3 usec	GLAT	SPD3
+122.9 usec	GVERT	
+132.1 usec	GLONG	N/A
+141.4 usec	N/A	BAT+

Output Characteristics

Output Type	Open Collector (drives to ground) with weak pull-up (10 k Ω) to battery positive
Current	0.5 A max, current limited and thermal overload protected
Output Clamp	70 V Flyback Clamp (no clamp diode to supply)

C127 Pin List by Pin Number

Pin	Name	Function
1	E-TX-	Ethernet Transmit -
2	E-TX+	Ethernet Transmit +
3	AV1	Analogue Voltage Input 1
4	AV2	Analogue Voltage Input 2
5	AV3	Analogue Voltage Input 3
6	AV4	Analogue Voltage Input 4
7	8V	Sensor 8 V
8	5V	Sensor 5 V
9	0v	Sensor 0 V Analogue Volt & Analogue Temp
10	E-RX-	Ethernet Receive -
11	E-RX+	Ethernet Receive +
12	AV5	Analogue Voltage Input 5
13	AV6	Analogue Voltage Input 6
14	DIG1	Digital Input 1
15	DIG2	Digital Input 2
16	AT1	Analogue Temp Input 1
17	AT2	Analogue Temp Input 2
18	CAN1L	CAN1 Lo
19	CAN1H	CAN1 Hi
20	RS232-1 TX	RS232-1 Transmit Output
21	SPD1	Speed Input 1
22	SPD2	Speed Input 2
23	SPD3	Speed Input 3
24	VID1	Video Input 1
25	RS232-2 RX	RS232-2 Receive Input
26	CAN2L	CAN2 Lo / RS232 Ground Input
27	CAN2H	CAN2 Hi / RS232 Receive Input
28	RS232-1 RX	RS232-1 Receive Input
29	AUX1	Auxiliary Output 1
30	AUX2	Auxiliary Output 2
31	AUX3	Auxiliary Output 3
32	AUX4 / LIN	Auxiliary Output 4 / LIN
33	BAT+	Battery Positive
34	BAT-	Battery Negative

C127 Pin List by Function

Pin	Name	Function
Battery Power		
34	BAT-	Battery Negative
33	BAT+	Battery Positive
Analogue Voltage Inputs		
3	AV1	Analogue Voltage Input 1
4	AV2	Analogue Voltage Input 2
5	AV3	Analogue Voltage Input 3
6	AV4	Analogue Voltage Input 4
12	AV5	Analogue Voltage Input 5
13	AV6	Analogue Voltage Input 6
Analogue Temp Inputs		
16	AT1	Analogue Temp Input 1
17	AT2	Analogue Temp Input 2
Digital Inputs		
14	DIG1	Digital Input 1
15	DIG2	Digital Input 2
Speed Inputs		
21	SPD1	Speed Input 1
22	SPD2	Speed Input 2
23	SPD3	Speed Input 3
Auxiliary Outputs		
29	AUX1	Auxiliary Output 1
30	AUX2	Auxiliary Output 2
31	AUX3	Auxiliary Output 3

Pin	Name	Function
32	AUX4 / LIN	Auxiliary Output 4 / LIN
8 V Sensor		
7	8V	Sensor 8 V
5 V Sensor		
8	5V	Sensor 5 V
0 V Sensor		
9	0V	Sensor 0 V
CAN Interface		
19	CAN1H	CAN 1 High
18	CAN1L	CAN 1 Low
27	CAN2H	CAN 2 High / RS232 Receive Input
26	CAN2L	CAN 2 Low / RS232 Ground Input
Ethernet		
10	E-RX-	Ethernet Receive -
11	E-RX+	Ethernet Receive +
1	E-TX-	Ethernet Transmit -
2	E-TX+	Ethernet Transmit +
RS232		
28	RS232-1 RX	RS232-1 Receive Input
20	RS232-1 TX	RS232-1 Transmit Output
25	RS232-2 RX	RS232-2 Receive Input
Video Input		
24	VID1	Video Input 1

Mounting Dimensions

C127

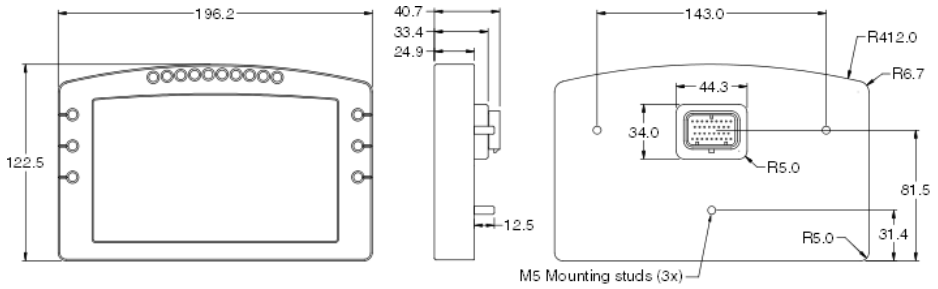

Note:

- All dimensions in [mm]
- Ensure product is not stressed when mounted
- Dimensions indicate actual product size, allow for clearance when mounting

Wiring

This section provides reference material about the Display Logger's connector and wiring requirements.

Connector

C127connector	34 pin connector
Mating connector	34 pin AMP connector #65044

Wire Specification

Wire

Wire to suit Display Logger connector: 22# Tefzel, Mil Spec : M22759/16-22

M22759/16 Wire Ratings (for various wire gauges)

Insulation Material: Tefzel

Conductor: Tin Plated Copper

Voltage Rating: 600 V

Maximum Temperature: 150 °C

Wire Gauge [AWG]	Cross Sectional Area [mm²]	Max Current at 100 °C Ambient [A]	Resistance [ohm/m]	Resistance [ohm / 1000 ft]
22	0.38	5	0.045	14.0
20	0.61	6	0.028	8.5
18	0.96	9	0.018	5.5
16	1.2	12	0.014	4.3
14	1.9	18	0.009	2.7
12	3.0	24	0.006	1.8

Wire Stripping Tool

Recommended: Ideal Industries 45-2133 stripping tool with LB1195 wire stop.

PC Connection**Ethernet Wiring Schematic:**

<i>CDL3 / C125 / C127</i>		<i>Ethernet Connector</i>	
<i>Pin</i>	<i>Function</i>	<i>Pin</i>	<i>Function</i>
11	Ethernet RX+	1	Ethernet TX+
10	Ethernet RX-	2	Ethernet TX-
2	Ethernet TX+	3	Ethernet RX+
1	Ethernet TX-	6	Ethernet RX-

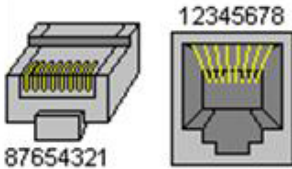
Pin numbering

Plug

Socket

Wire

CAT5 UTP Ethernet cable

Cable

An Ethernet RJ45 socket, connecting to a standard Ethernet cable, is provided on:

- #62204 C125 Race Loom Terminated (used on both C125 and C127)
- #61131 Ethernet cable, unterminated, 2 metre

CAN Bus Wiring Requirements

- The CAN bus should consist of a twisted pair trunk with 100R (0.25 watt) terminating resistors at each end.
 - If the CAN bus is less than 2 metres (7 ft) long, a single termination resistor may be used.
- The preferred cable for the trunk is 100R data cable.
- The maximum length of the bus is 16 metres (50 ft)
- CAN devices (such as MoTeC Display Loggers, ECUs etc.) may be connected to the trunk with up to 500 mm (20 in) of twisted wire.

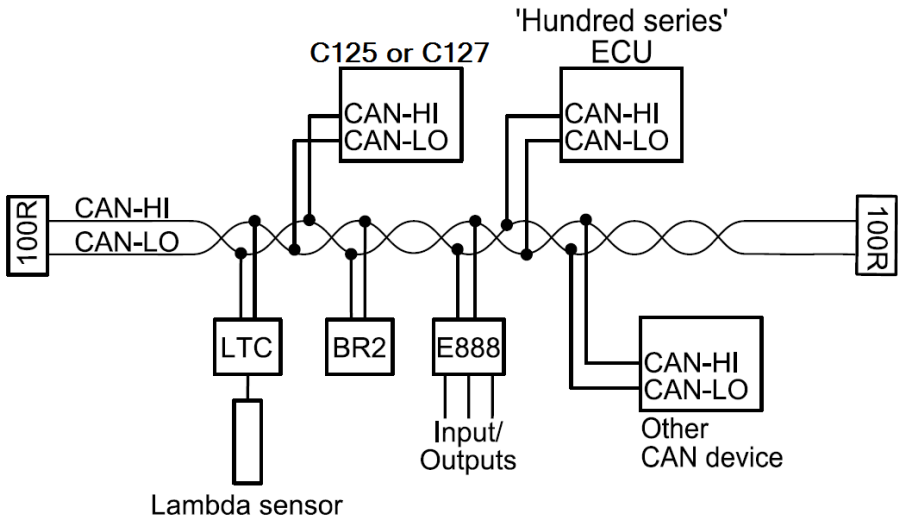

C127 Display Logger to ECU wiring (RS232)

The following details the methods for connecting the Data Logger to various MoTeC ECUs via RS232. In all cases this is done using the serial data stream generated by the Telemetry function of each ECU.

In the case of the M800, M880 and M4e the Data Logger may be directly wired to the ECU because these ECUs use RS232 interface levels. On the M48, M4 (pre M4e) and the M8, a Computer Interface Module (CIM) or a PCI cable is required to convert the signals to RS232.

M4e

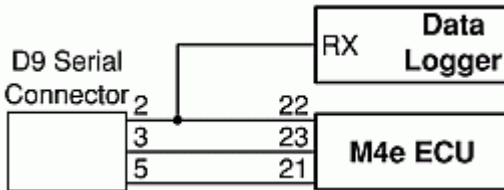

Note:

- Older M4 ECUs require a different connection method
- The data to the Display Logger will be interrupted while a PC is connected.

M48, M4 (pre M4e) and M8

The M48, M8 and M4 (pre M4e) require the use of a CIM module or a PCI Cable to convert the logic level signals used by these ECUs into RS232 levels.

Using a CIM Module

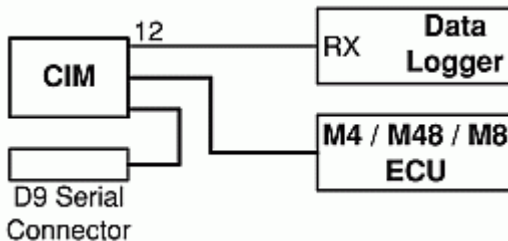

Contact MoTeC for the CIM module drawing for full wiring details.

Note:

- The data stream to the Display Logger will be interrupted while a PC is connected.

C125 Race Loom Terminated Wiring (part 62204)

This loom is used on both the C125 and C127.

34 Pin Tyco
CDL3C
Connector

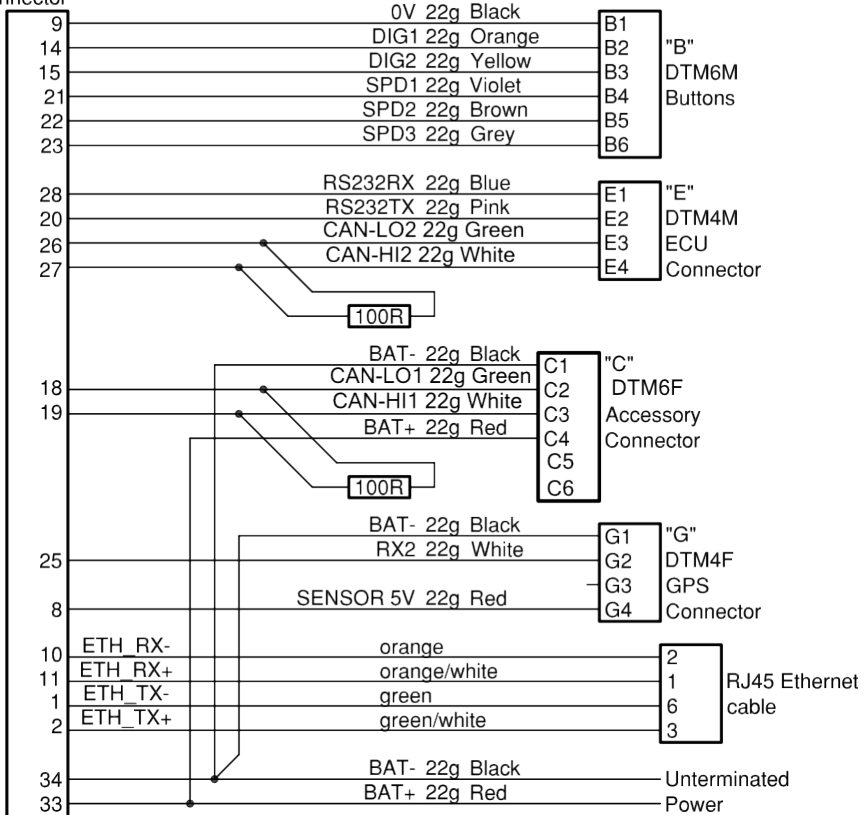

Update Rate Summary

<i>Device</i>	<i>Input Type</i>	<i>Maximum Update Rate (per second)</i>
ADL3	Analogue Voltage Inputs	1000
ADL3	Analogue Temperature Inputs	1000
ADL3	Digital Inputs and Speed Inputs	100
ADL3	RS232 and CAN Communications	50 max *
ADL3	CAN comms fast receive	1000
ACL	RS232 Communications	200 *
ACL	General CAN communications	200 *
CDL3/C125/C127	Analogue Voltage Inputs	500
CDL3/C125/C127	Analogue Temperature Inputs	500
CDL3/C125/C127	Digital Inputs and Speed Inputs	100
CDL3/C125/C127	RS232 and CAN Communications	50 max *
CDL3/C125/C127	CAN comms fast receive	500
VIM	AV Fast Inputs	5000
VIM	AV Differential Voltage Inputs	1000
VIM	AV High Resolution Inputs	500
VIM	AV Special Inputs	2000
VIM	Speed Inputs	100
ADL2/SDL	Analogue Voltage Inputs 1 to 4 (ADL2/SDL) and 11 to 14 (ADL2)	1000
ADL2/SDL	Other Analogue Voltage Inputs	500
ADL2/SDL	Analogue Temperature Inputs	500
ADL2/SDL	Lambda Inputs	100
ADL2/SDL	Digital & Speed Inputs	100
SDL	Internal G Sensors	100
E888	Thermocouple Inputs (First Device / Second Device)	100 / 50
E888/816	Analogue Voltage & Digital Inputs (First Device / Second Device)	200 / 50

* RS232 and general CAN communications update rate depends on how frequently the data is sent from the device. Typically the update rate from an M4, M48, M8 or M800 ECU is about 20 times per second using RS232 and about 50 times per second for the M800 and M84 using CAN.

Command Line

Usage:

Clubdash3.exe -c[connection] -d -x -l -e -t -s [config file name]

[config file name]

(Optional)

Fully qualified path to the configuration file.

(eg "c:\motec\dash\config\bathurst.d30")

Note: the path must include the file extension (e.g. .d30)

Options :

Each of the following options can be given as "[character]" or "-[character]". They are shown here as "-[character]".

-c[Connection Name]

(Optional)

Select a preconfigured connection by name as configured in the dash connections dialog.

(e.g. -c"Primary CAN Connection").

Note: There must not be a space between the c and the connection name.

-d

(Optional)

Causes the debug console to be displayed.

Only available for debug builds.

-x

(Optional)

Causes the app to terminate when one of the following tasks has been performed.

Tasks :

One or more of the following may be specified.

-l

(Optional)

Perform a "Get Logged Data" operation.

-e

(Optional)

Perform a "Get Engine Log" operation.

-t

(Optional)

Perform a "Get Tell-tale Values" operation.

-p

(Optional)

Perform a "Print Summary" operation.

Note: The configuration file must be specified using a fully qualified path including the file extension.

(e.g. -p "c:\motec\dash\config\bathurst.d30")

Note: There must be a space between -p and configuration file name.

-s

(Optional)

Perform a "Send Configuration" operation.

Note: The configuration file must be specified using a fully qualified path including the file extension.

(e.g. -s "c:\motec\dash\config\bathurst.d30")

Note: There must be a space between -s and configuration file name.

-u

(Optional)

Perform an "Upgrade Dash Version" operation.

CAN Bus Bandwidth Limit

The total available CAN bandwidth on a single CAN bus is 1 Mbit/sec.

The bandwidth used by the total of all devices on a particular CAN bus must not exceed approximately 90% of this value (900000 bits/second)

If the total bandwidth required exceeds this specification then some devices should be connected to the second CAN bus.

Note: Dash Manager will warn if the bandwidth is likely to be exceeded.

E888

Device on first CAN Address: Bandwidth = 145000 (bits/sec)

Device on second CAN Address: Bandwidth = 55000 (bits/sec)

Other Devices

<i>Device</i>	<i>Bandwidth</i>
BR2, SLM, PLM	Negligible
SDL, ADL2, MDD, M800 ECU	TBD

Comms Error Codes

The "Comms CAN x Diagnostic" and "Comms RS232 Diagnostic" channels can be used to diagnose communications problems.

Multiple errors are shown by error codes added together. For example: A RS232 error of 9 = parity + overrun.

The error values have the following definitions:

RS232 Errors

Errors generated by RS232 communications.

1	PARITY	Parity bit incorrect. The comms parity setup is wrong, or there is electrical interference causing errors in the data.
2	FRAMING	Not seeing the stop bit. The baud rate or stop bit setup is wrong or there is electrical interference causing errors in the data.
4	NOISE	Glitch in the data. Electrical interference is causing glitches in the signal. (the Display Logger does not generate this error)
8	OVERRUN	A byte was received before the previous byte was read indicating that the processor was too busy to read the message.
512	NO DATA	A valid message header was not found - either there is a wiring fault or comms is setup incorrectly.
1024	CHECKSUM	A valid message header was found, but the checksum was wrong. If seen in combination with other errors there is electrical noise. If only checksum errors occur there may be a software incompatibility between the Display Logger and the other device.
2048	WRONG DATA	Could not decode the protocol.

General CAN Errors

Errors generated by general CAN communications.

2	FRAMING	Only generated when used with an E888/E816 expander. Inconsistent message length.
8	OVERRUN	Receive or transmit overrun error. In the receive case a byte was received before the previous byte was read indicating that the processor is too busy to read the message. In the transmit case the transmit buffer is full which could happen if the CAN bus is too busy.
256	BAD CONFIG	The device configuration is not valid (e.g. overlapping CAN addresses)
512	NO DATA	A valid message header was not found - either there is a wiring fault or comms is setup incorrectly, (problem could be at either end), e.g. transmit and receive CAN IDs do not match.
1024	CHECKSUM	Only generated when used with an Async Expander. See RS232 Errors .
2048	WRONG DATA	Only generated when used with an Async Expander or E888/E816 Expander. Async Expander: Could not decode the protocol. E888/E816: Compound ID incorrect.
4096	BUS WARNING	More than 96 errors have occurred on the CAN bus. Check wiring and termination resistors. The CAN bus may still be operational.
8192	BUS OFF	More than 255 errors have occurred on the CAN bus. CAN communications is suspended when this error occurs. Check wiring, termination resistors and the CAN baud rate. Also check that CAN HI and CAN LO are correct (not swapped).
16384	CAN TRANSMIT	CAN bus transmit warning

"VIMCOM" Errors

Errors generated by "VIMCOM" devices (SVIM, Display Loggers).

Note: VIMCOM devices are connected via CAN.

Display Logger Errors (C127)

These errors are generated by the Display Logger's communications system.

2	FRAMING	Incorrect number of samples received.
256	BAD CONFIG	Configuration mismatch between Display Logger and device. Resend the configuration.
512	NO DATA	VIMCOM packets have not been found. Either there is a wiring fault or Display Logger Connections is setup incorrectly.
2048	WRONG DATA	VIMCOM packet has bad length.
4096	BUS WARNING	More than 96 errors have occurred on the CAN bus. Check wiring and termination resistors. The CAN bus may still be operational.
8192	BUS OFF	More than 255 errors have occurred on the CAN bus. CAN communications is suspended when this error occurs. Check wiring, termination resistors and the CAN baud rate. Also check that CAN HI and CAN LO are correct (not swapped).

VIMCOM Device Errors.

These error codes are sent once by the VIMCOM device on resuming data transmission and therefore indicate why data was previously not being transmitted.

4097	STARTUP	Device has restarted (normally due to power up). Data is not sent until sync is achieved.
4098	HALT	Data not sent due to deliberate halt. For example configuration or firmware being sent.
4099	OVERRUN	Data not sent due to transmit buffer overrun (possibly due to CAN bus too

		busy)
4100	SYNC TIMEOUT	Data not sent due to Display Logger sync message timeout (sync not received from Display Logger)
4101	CAN ERROR	Data not sent due to error on CAN bus
4102	SYNC EXCEEDED	Data not sent due to excessive sync error (synchronisation too far out)

Windows Keyboard Shortcuts

When using a laptop in and around a car, it is often not practical to use a mouse to navigate through the program.

Using the keyboard to select options is easier.

Main Menu

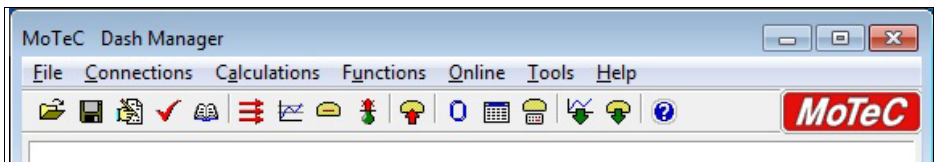

To access the main menu, press ALT + the key for the underlined letter in the menu, followed by the underlined letter of the item in the drop down menu, e.g. ALT + F, N for File New.

Alternatively press and release ALT, select the desired menu item using the arrow keys, press ENTER to activate it.

Closing a Window

Press ENTER for OK or Close (only when the OK or Close button has a bold line around it)

Press ESC to Cancel or Close

Getting Help

Press F1 to get help on the current window or item

Select Help from the Main Menu to access the main help system.

Selecting an Item in a Window

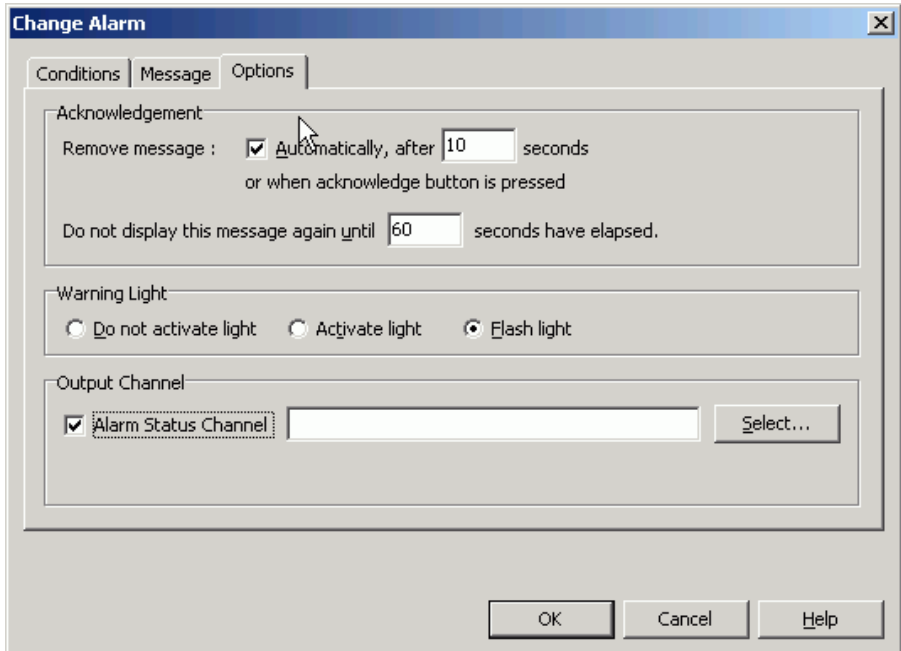

To access the various items in a window, press ALT + the key for the underlined letter of the item of interest, e.g. to select the 'Flash Light' item press ALT + F

Alternatively use the TAB key to move through the dialog box (use SHIFT + TAB to move backwards). The selected control is usually indicated by a dotted line around it, or by highlighting the text or item selected within the control.

Using the Selected Item

The method of using the selected item (or control) depends on the type of control. The common controls are detailed below:

Command Button



Command buttons are generally used to show another screen or perform a particular function.

Press ALT + the key for the underlined letter (S), or use the TAB key to navigate to the command button. To select, press ENTER or SPACEBAR.

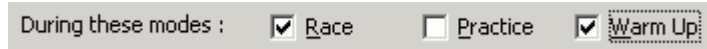
Check Box

A check box is used to tick on or off a particular option.

Press ALT + the key for the underlined letter (E), or use the TAB key to navigate to the Check Box. To select, press SPACEBAR.

Group Box

The Group box is used to select an item from a group of options.

Press ALT + the key for the underlined letter (E, A or D), or use the TAB key to navigate to the Group box. To select, use the arrow keys.

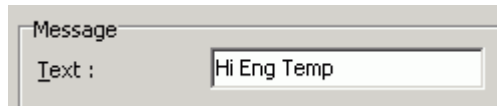
Text Box

A text box is used to enter a value or text.

Press ALT + the key for the underlined letter (M) or use the TAB key to navigate to the Text box, type in the new value or text. Use BACKSPACE or DELETE to remove unwanted characters.



A list is used to select from a number of options.

Press ALT + the key for the underlined letter (M) or use the TAB key to navigate to the List Box. To select, use the arrow keys.

Drop-down List Box

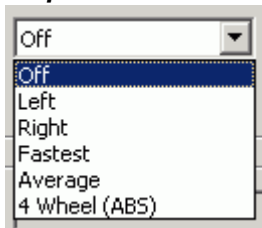

A Drop-down list box is used to select from a number of items, but only the selected item is shown until a new item needs to be selected.

Press ALT + the key for the underlined letter (L) or use the TAB key to navigate to the Drop down List Box. To select the desired item, use the arrow keys, and press ENTER to close the list.

Tabs



Tabs are used to select the different tab pages of a screen.

To select the next tab, press CTRL + TAB. To select the previous tab, press CTRL + SHIFT +TAB.

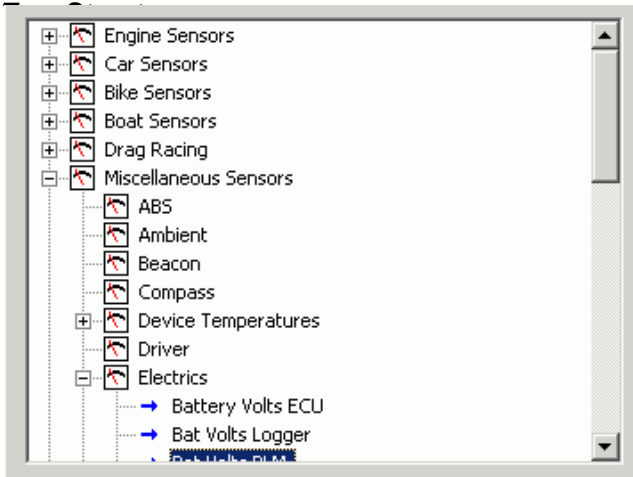

A Tree Structure is used to select items from a hierarchical list

The UP ARROW key moves the cursor up (selects the item above)

The DOWN ARROW key moves the cursor down (selects the item below)

The RIGHT ARROW key expands; expandable branches indicated by a plus sign (+)

The LEFT ARROW key collapses; collapsible branches indicated by a minus sign (-)

Screen Cleaning

Gently wipe using a clean water dampened microfibre cloth, followed by a clean dry microfibre cloth.

Glossary

MoTeC Devices	
ACL	Advanced Central Logger
ADL2	Advanced Display Logger - second generation
ADL3	Advanced Display Logger - third generation
BR2	Beacon Receiver
BTX	Beacon Transmitter
CIM	Computer Interface Module
CLS	Central Logging System
C125	Colour Display Logger
C127	7" Colour Display Logger
C185	Colour Display Logger
C187	7" Colour Display Logger
CDL3	Club Display Logger
DBW4	Drive By Wire expander
E816	Input/Output Expander
E888	Input/Output Expander
i2	MoTeC data analysis software
i2 Pro	MoTeC data analysis software, professional version
IEX	Ignition Expander
LTC	Lambda to CAN module
LTCD	Lambda to CAN Dual module
M2R	ECU dedicated to run 2 rotor engines
M4	ECU for engines with up to 4 cylinders or up to 2 rotors
M400	ECU for modern engines with up to 4 cylinders or up to 2 rotors
M48	ECU for engines with up to 8 cylinders and 2 rotors
M600	ECU for modern engines with up to 6 cylinders or up to 3 rotors
M800	ECU for modern engines with up to 12 cylinders or up to 4 rotors
M800 Plug-In	ECU for direct replacement of a factory ECU

M880	ECU for modern engines with up to 12 cylinders or up to 4 rotors
MDC	Mitsubishi Diff Controller
MDD	Mini Digital Display
MLS	ECU dedicated to run Chevrolet LS1 and Lexus/Toyota V8s
PCI Cable	PC Interface cable
PDM15	Power Distribution Module with 15 outputs
PDM16	Power Distribution Module with 16 outputs
PDM30	Power Distribution Module with 30 outputs
PDM32	Power Distribution Module with 32 outputs
PLM	Professional Lambda Meter
RTC	Real Time Clock
SDC	Subaru Diff Controller
SDL	Sport Display Logger
SDL3	Sport Display Logger – second generation
SGA	Strain Gauge Amplifier
SLM	Shift Light Module
SLM-C	Shift Light Module – Club version
SUU	Software Update Unit
TCM	Traction Control Module
VIM	Versatile Input Module
Other	
Calibration	The process of converting an electrical value into a physical value, e.g. volts into kilometres per hour
CAN	Controller Area Network - communication protocol
CDI	Capacitive Discharge Ignition
ECU	Engine Control Unit
GPS	Global Position System
MAF	Mass Air Flow
MAP	Manifold Absolute Pressure
PID	Proportional, Integral and Derivative gain
PWM	Pulse Width Modulated

RPM	Revolutions Per Minute
RS232	Recommended Standard 232, communication protocol
RX	Receive
TDC	Top Dead Centre
TX	Transmit

