

A81.06.O

OFFSET WALL SET

[AVAILABLE WITH FLOW CONTROL, ADD **.FC** TO END OF CODE - 6 STAR/3.5Lpm WELS RATING]

STANDARD WITH INDENT HANDLE
OTHER LEVER HANDLE OPTIONS

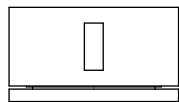
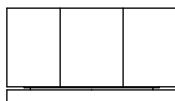

.V2 PIN HANDLE

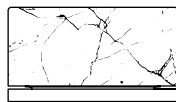

.V3 WHITE CARRARA MARBLE
.V4 BLACK MARQUINA MARBLE

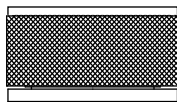

.V5 KNURLED

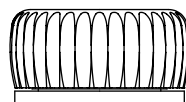

.V6 REEDED

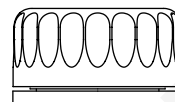

.V7 FLUTED

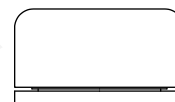

.V8 ROUND DIAL

- Tapware to be installed by a licenced plumber in accordance with AS/NZS 3500:2003
- Recommended working water pressure 150 - 500kPa
- Maximum water temperature is 65 deg C
- After completing the installation check function of tapware and ensure no water leaks.

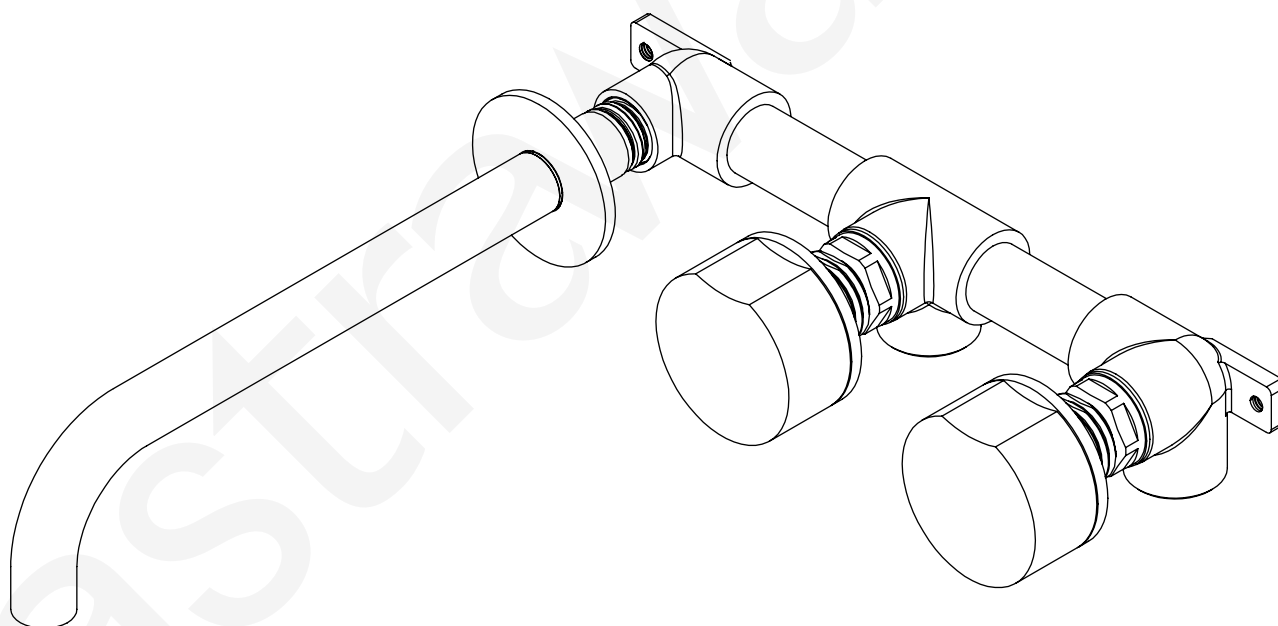

ASSEMBLY VIEW

A81.06.O

OFFSET WALL SET

[AVAILABLE WITH FLOW CONTROL, ADD **.FC** TO END OF CODE - 6 STAR/3.5Lpm WELS RATING]

Install wall breach to a secure nogging at the correct depth as shown in the drawing below. Ensure the breach is square and parallel between the wall studs. To allow the tapware to fit correctly the thickness of the finished wall surface must be calculated prior to 'rough-in'.

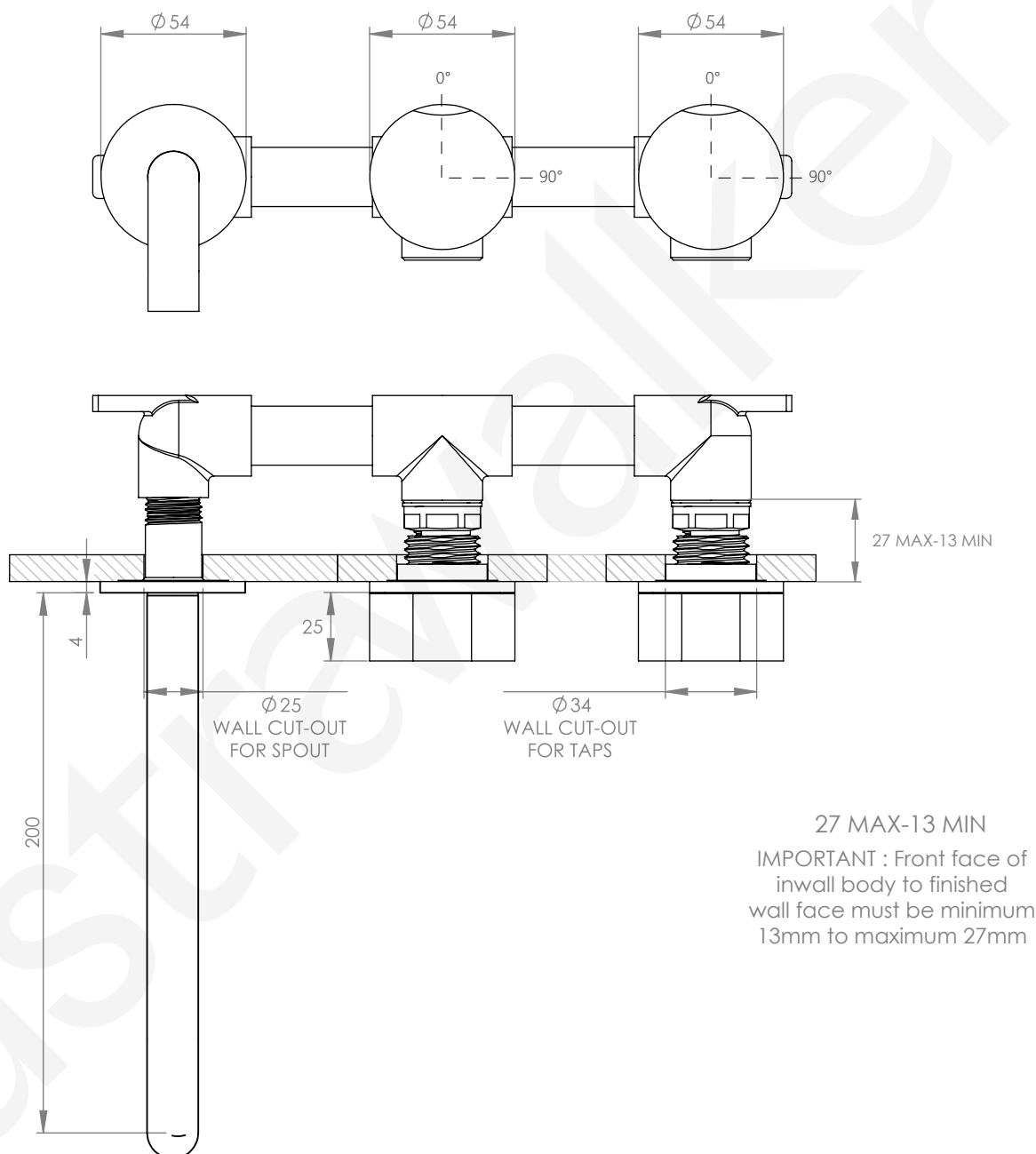

NOTE : Seat of Breach Body extensions are NOT recommended in conjunction with this Tapware. Failure to adhere will void warranty.

A81.06.O

OFFSET WALL SET

[AVAILABLE WITH FLOW CONTROL, ADD **.FC** TO END OF CODE - 6 STAR/3.5Lpm WELS RATING]

Ensure water lines are completely flushed prior to fitting of spindles.

Install the spindles hand-tight until the seal of the spindle firmly makes contact with the seat. Do not overtighten. Do not tighten seal using the spindle.
Fit washer and screw down locknut over the spindle using an appropriate tube spanner and tighten.

NOTE: Over-tightening the spindles could damage the ceramic discs and in turn, void the manufacturer's warranty.

Seal the wall around the spindle and fit the flange to meet the finished wall surface.

Remove handle insert from spindle, and cut spindle to suit installation.

Re-fit and tighten the handle insert to spindle.

Attach handle to the handle insert and adjust into correct position, and tighten well using an Allen Key.

