

# NHL-VTE3-2-25W-CT-UNV

## 2' LED VAPOR TIGHT FIXTURE

### DESCRIPTION

2' LED Vapor Tight Fixture | 120 – 277V Input |  
Frosted Lens | 0 –10V Dimming

### APPLICATION

Used for commercial and industrial rugged  
or outdoor applications



### PRODUCT FEATURES

- Features Color Select technology. Adjust CCT between 3500K, 4000K, or 5000K
- Features Power Select technology. Adjust power between 25W, 20W, and 15W
- Powered by 0 –10V dimming LED drivers
- Traditional design, narrow body, Vapor Tight fixture, suitable for rugged, demanding applications
- NEMA 4X rated, protected against corrosion
- Compatible with occupancy sensors
- Ambient operating temperature: -20°C/-4°F to 45°C/122°F
- IP66, suitable for wet location
- ETL Sanitation Listed NSF/ANSI Standard 2 - Food Equipment, Splash Zone (Not for Direct Food Zone)
- THD: < 20%
- Power factor > 0.95

### POWER AND COLOR TEMPERATURE SELECTABILITY

- Color Select Technology: Adjustable CCT (3500K/4000K/5000K)
- Power Select Technology: Adjustable Wattage (25W/20W/15W)

### PRODUCT SPECIFICATIONS

Catalog Number	Input Voltage	Wattage	CCT	Lumen Output	Efficacy	CRI	Power Factor	Lifetime
NHL-VTE3-2-25W-CT-UNV	120 –277V	25W	3500K	3,250	130 lm/W	> 80	> 0.90	50,000 hrs
			4000K	3,275	131 lm/W			
			5000K	3,300	132 lm/W			
		20W	3500K	2,660	133 lm/W			
			4000K	2,680	134 lm/W			
			5000K	2,700	135 lm/W			
		15W	3500K	2,040	136 lm/W			
			4000K	2,055	137 lm/W			
			5000K	2,070	138 lm/W			

### ONE CATALOG NUMBER WITH 9 DIFFERENT OPTIONS

\* Preset to highest lumen output (25W / 5000K)

\* Color Uniformity: CCT (Correlated Color Temperature) range as per guidelines outlined in ANSI C78.377-2017.

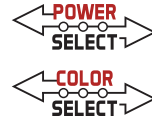

# NHL-VTE3-2-25W-CT-UNV

## 2' LED VAPOR TIGHT FIXTURE

### PHOTOMETRIC SPECIFICATIONS

ISOCANDELA PLOT

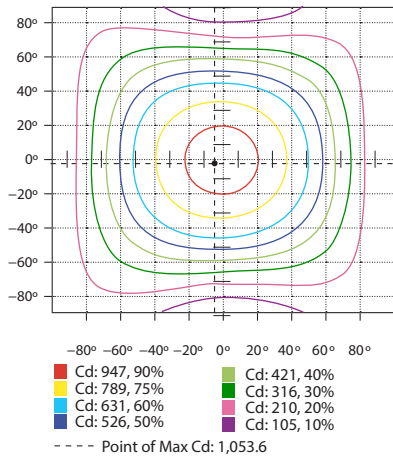

POLAR CANDELA DISTRIBUTION

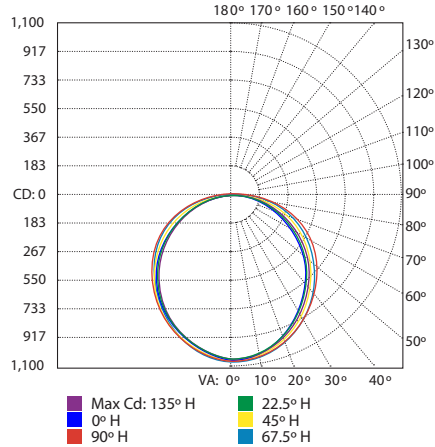

ZONAL LUMEN SUMMARY

Zone	Lumens	% Luminaire
0-60	2,303.8	69.50%
60-90	826.9	25.00%
0-90	3,130.8	94.50%
90-180	182.3	5.50%
0-180	3,313.0	100.0%

### PHYSICAL SPECIFICATIONS

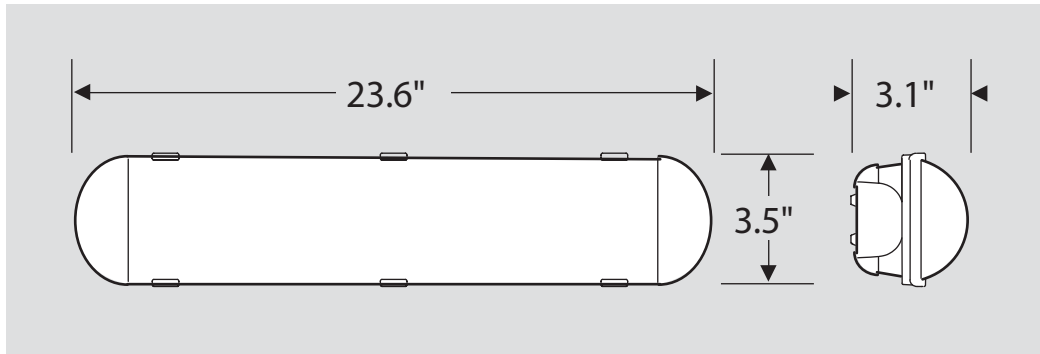

### WIRING DIAGRAMS

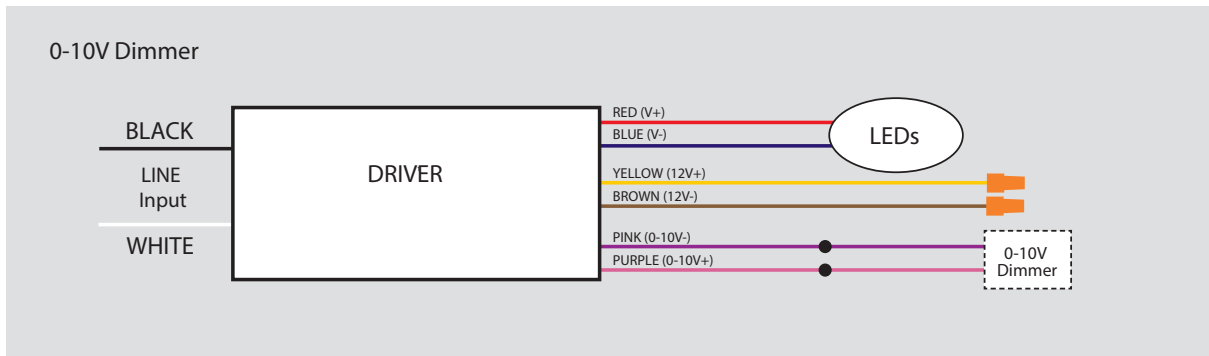

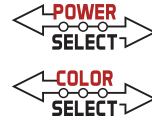

# NHL-VTE3-2-25W-CT-UNV

## 2' LED VAPOR TIGHT FIXTURE

**ACCESSORIES**

**SENSORS**

Factory-Installable OR Field-Installable (field-installable purchased separately)

	SUFFIX*	CATALOG NUMBER	DESCRIPTION		
✓	MW3	NHL-MW3	Microwave Sensor Kit, Includes 120-277V input to 12V DC convertor, IP65 12V input sensor head, nomex sleeve, extension neck		



\* FOR FACTORY INSTALLATION OF ACCESSORY, ADD SUFFIX TO FIXTURE PART NUMBER (SEE ORDERING EXAMPLES AND INSTRUCTIONS ON LAST PAGE OF SPEC SHEET).

**MOUNTS AND BRACKETS**

Field-Installable / Field-Use ONLY (purchased separately)

CATALOG NUMBER	DESCRIPTION
NHL-MB45	45° steel surface mount kit for all vapor tight fixtures
NHL-TPSCW/SS	Screws for tamper-proofing vapor tight fixtures. Includes 14 screws



\* FOR FACTORY INSTALLATION OF ACCESSORY, ADD SUFFIX TO FIXTURE PART NUMBER (SEE ORDERING EXAMPLES AND INSTRUCTIONS ON LAST PAGE OF SPEC SHEET).

(Accessories continued on next page)

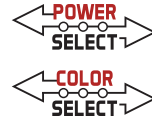

# NHL-VTE3-2-25W-CT-UNV

## 2' LED VAPOR TIGHT FIXTURE

### ORDERING INFORMATION

Catalog Number			
NHL-VTE3-2-25W-CT-UNV			

### CATALOG NUMBER BREAKDOWN

# NHL-VTE3-2-25W-CT-UNV

- 1
- 2
- 3
- 4
- 5
- 6

- 1 Keystone Technologies
- 2 LED Vapor Tight Fixture
- 3 2' Nominal Length
- 4 Wattage
- 5 Color Select
- 6 Voltage

#### Color Select Designation

	3500K, 4000K, 5000K
--	---------------------

#### Sensor Options

	No Option
	Microwave Sensor included

NOTE: ALL ACCESSORIES CAN ALSO BE ORDERED SEPARATELY FOR FIELD INSTALLATION USING JUST THEIR REGULAR CATALOG NUMBER,