

# NHL-CBE2-22-24W-CT-UNV

## LED CENTER BASKET FIXTURE

### DESCRIPTION

2' x 2' LED Center Basket Fixture | 120 – 277V Input |  
Frosted Lens | 0 –10V Dimming

### APPLICATION

Used for commercial recessed ceiling applications



**5 YEAR**  
WARRANTY

### PRODUCT FEATURES

- Features Color Select technology. Adjust CCT between 3500K, 4000K, or 5000K
- Features Power Select technology. Adjust power between 24W, 18W, and 15W
- Powered by 0 –10V dimming LED drivers with 12V Aux
- Architectural grade center basket volumetric design
- Ambient operating temperature: -20°C/-4°F to 50°C/122°F
- Compatible with New Horizon Lighting supplied emergency batteries
- Available with optional integral occupancy sensor accessory, NHL-FC2-12V-SM-PIR
- Low optical flicker
- THD: < 20%
- Power factor > 0.95
- IC Rated

### POWER AND COLOR TEMPERATURE SELECTABILITY

- Color Select Technology: Adjustable CCT (3500K/4000K/5000K)
- Power Select Technology: Adjustable Wattage (24W/18W/15W)

### PRODUCT SPECIFICATIONS

Catalog Number	Input Voltage	Wattage	CCT	Lumen Output	Efficacy	CRI	Power Factor	Lifetime
NHL-CBE2-22-24W-CT-UNV	120 –277V	24W	3500K	3,072	128 lm/W	> 80	> 0.90	50,000 hrs
			4000K	3,096	129 lm/W			
			5000K	3,120	130 lm/W			
		18W	3500K	2,412	134 lm/W			
			4000K	2,430	135 lm/W			
			5000K	2,448	136 lm/W			
		15W	3500K	2,055	137 lm/W			
			4000K	2,070	138 lm/W			
			5000K	2,085	139 lm/W			

ONE CATALOG NUMBER WITH 9 DIFFERENT OPTIONS

\* Preset to highest lumen output (24W / 5000K)

\* Color Uniformity: CCT (Correlated Color Temperature) range as per guidelines outlined in ANSI C78.377-2017

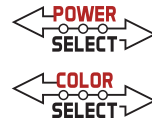

# NHL-CBE2-22-24W-CT-UNV

## LED CENTER BASKET FIXTURE

### PHOTOMETRIC SPECIFICATIONS

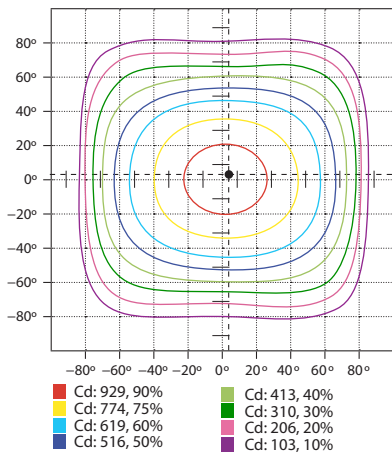

### POLAR CANDELA

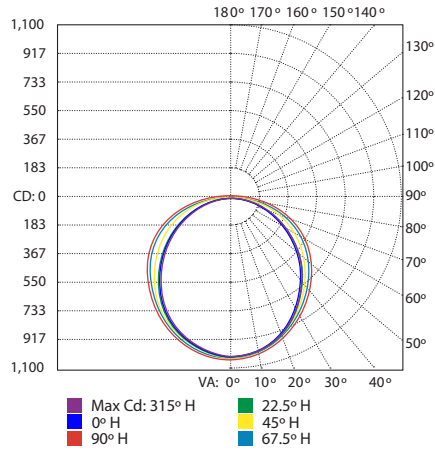

### ZONAL LUMEN SUMMARY

Zone	Lumens	% Luminaire
0-60	2,327.3	75%
60-90	768.5	24.80%
0-90	3,095.8	99.70%
90-180	9.0	0.30%
0-180	3,104.8	100%

### PHYSICAL SPECIFICATIONS

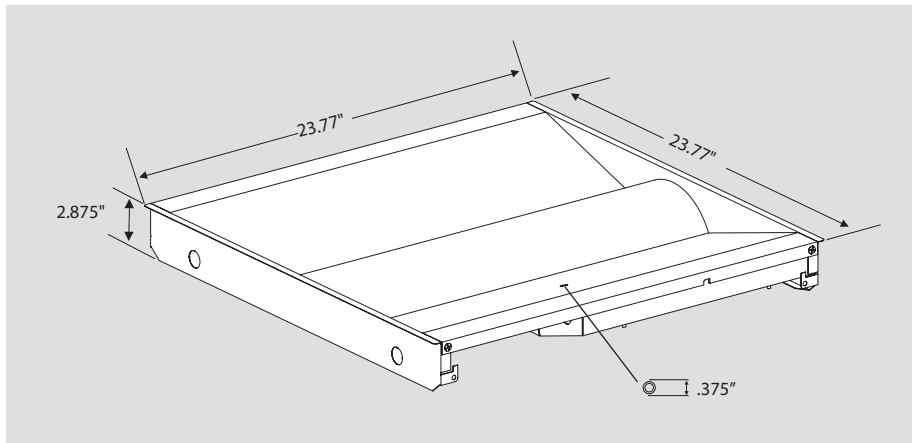

### WIRING DIAGRAMS

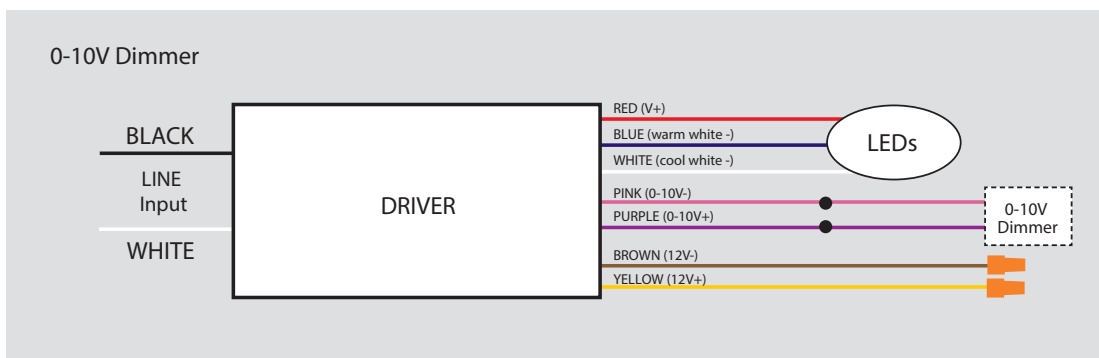

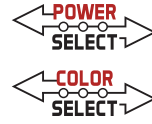

# NHL-CBE2-22-24W-CT-UNV

## LED CENTER BASKET FIXTURE

### WIRING DIAGRAMS (CONTINUED)

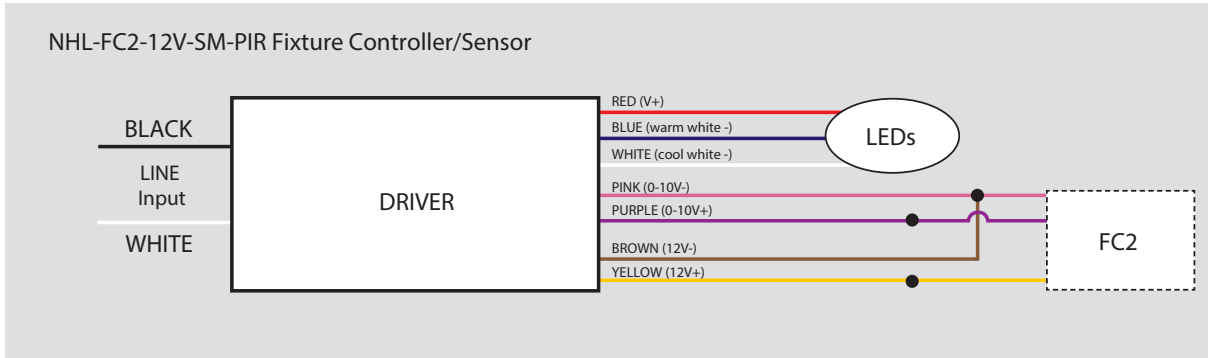

### ADDITIONAL ACCESSORIES (SOLD SEPARATELY)

Catalog Number	Description
NHL-BLEDEM-CP-1200	8W, 1200 lumen Smart Safe emergency backup with dual flex cables.
NHL-BLEDEM-CP-2400	17W, 2400 lumen Smart Safe emergency backup with dual flex cables, self diagnostic.
NHL-FC2-12V-SM-PIR	Bluetooth mesh wireless low voltage fixture controller for system with integrated daylight and PIR motion sensors



Fixture installed with NHL-FC2-12V-SM-PIR

### ORDERING INFORMATION

Catalog Number	Pack Quantity
NHL-CBE2-22-24W-CT-UNV	TBD

### CATALOG NUMBER BREAKDOWN

# NHL-CBE2-22-24W-CT-UNV

- 1
- 2
- 3
- 4
- 5
- 6

- 1 New Horizon Lighting
- 2 LED Center Basket Fixture
- 3 2X2' Nominal Length
- 4 Wattage
- 5 Color Select Designation
- 6 Voltage

#### Color Select Designation

A	3500K, 4000K, 5000K
---	---------------------

#### Sensor Options

	No Option
FC2-12V-SM-PIR	SmartLoop PIR sensor included