

ADV200 SP

Variateur de pompage Solaire Hybrid



GEFRAN

BEYOND TECHNOLOGY

ENERGIZE SARL 0808539030

GEFRAN

BEYOND TECHNOLOGY

Over fifty years of experience, an organisation highly focused on the customer's needs and constant technological innovation make Gefran a benchmark in the design and production of sensors and components for industrial process automation and control.

Expertise, flexibility and process quality are the factors that distinguish Gefran in the production of integrated tools and systems for specific applications in various industrial fields, with consolidated know-how in the plastics, mobile hydraulics, heating and lift sectors.

Technology, innovation and versatility represent the catalogue's added value in addition to the ability to create specific application solutions in association with the world's leading machine manufacturers.



APPLICATIONS



FLOOD IRRIGATION



PIVOT IRRIGATION



WATER SUPPLY IN RURAL ZONES



WATER EXTRACTION FOR
HUMAN USE



WASTEWATER TREATMENT



FISH FARMING

APPLICATION ORIENTED

Gefran is strongly committed to improving livelihoods, sustainability and energy efficiency in various sectors and geographical areas.

Increasing awareness of the potential benefits of solar technology combined with water pumping systems has generated an ever more widespread need in many different contexts, ranging from developing countries to rural areas.

Leveraging on its high-end technology, its know-how in drives and motion systems and its application-oriented approach, Gefran has developed an effective solution for solar-powered and dual-supply pumping systems.

SOLAR PUMP APPLICATION

Solar-powered water pumping is based on PV technology that converts sunlight into electricity to pump water.

The PV panels are connected to an ADV200 SP drive, which converts the electrical energy supplied by the PV panel into mechanical energy, and this in turn is converted into hydraulic energy by the pump.

Synergies between the ADV200 SP Industrial Drives technology and the company's Solar and Pump application know-how have allowed Gefran to develop a special SW app to optimize the operation of solar pump systems. As a result of the built-in MPPT dynamic search algorithm developed by Gefran, the ADV200 SP drive continuously adapts the System load at maximum output power under varying irradiation and temperature conditions. MPPT is the ideal choice to obtain the maximum pumping supply from photovoltaic cells, under any condition.

The ADV200 SP manages pumping systems powered by different sources: solar PV panels alone (off-grid), or both PV panels and grid supply (dual supply systems).

MAXIMUM EFFICIENCY AND PERFORMANCE IN ANY RADIATION AND TEMPERATURE CONDITION

The Maximum Power Point Tracking algorithm (MPPT) is an integrated controller ensuring maximum output power from solar panels so as to obtain the best pump performance in any weather condition.

By matching the MPPT controller with the dual-supply operation mode, it is possible to achieve:

- > Performance optimization
- > Continuous operation
- > Energy savings

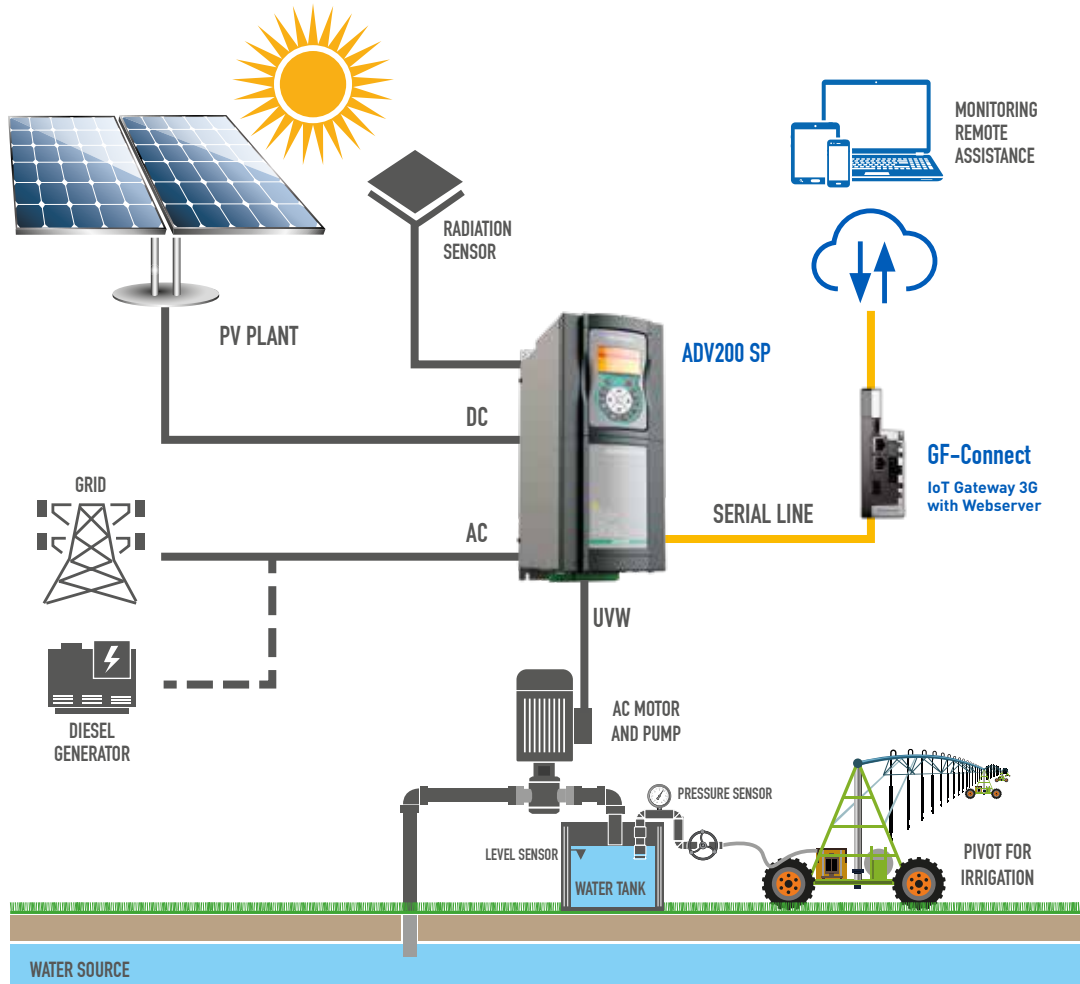
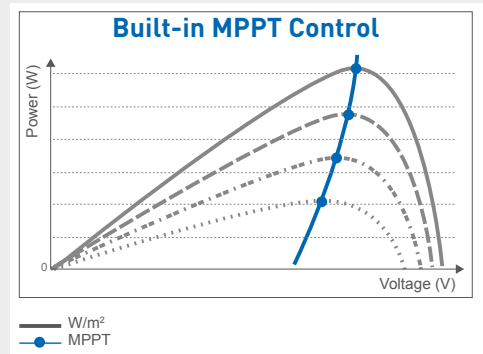

GENERAL CHARACTERISTICS

Power supply	DC: 330..800 Vdc AC: 380 Vac -15% ... 480 Vac +10%, 50/60 Hz, ± 5%	
MPPT voltage range	350..750 Vdc	
MPPT efficiency	Up to 99.9%	
Power Range	From 1.5 kW to 160 kW	
Overload	Light Duty: 110 % x In (for 60") Heavy Duty: 150 % x In (1' each 5'), 180 % x In (for 0.5")	
Control mode	Open loop V/f Open-loop vector control	
DC Choke	Integrated choke on DC side	
Programming keypad	Integrated KB_ADV	
Communication	Integrated RS485 serial line (Modbus RTU)	
Real Time Clock	Integrated	
SW features	Integrated MPPT control and optimisation Dual source control Double PID Specific functions for pump control	
Environmental conditions	Ambient temperature	-10°C ... +40°C (+14°F ...+104°F), +40°C...+50°C (+104°F...+122°F) with derating
	Altitude	Max 2000 m. (up to 1000 m without derating)
Markings		Complies with the EC directive concerning low voltage equipment (Directives LVD 2014/35/EU, EMC 2014/30/EU, RoHS 2011/65/EU)
		UL and cULus, Complies with directives for the American and Canadian markets

SPECIAL SOLAR PUMP FEATURES

MPPT CONTROL

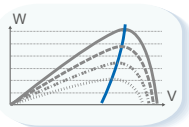

AUTO START & STOP

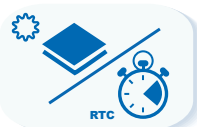

DUAL SOURCE

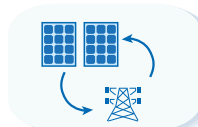

PUMP TYPES



PRESSURE & FLOW CONTROL

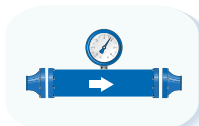

TANK LEVEL CONTROL



DRY RUN



SYSTEM PROTECTION



MONITORING



ENERGY SAVINGS



MINIMUM SPEED



PUMP CLEANING

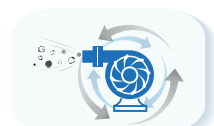

MAIN FEATURES



PRODUCT RANGE

Size	Power (LD)	DC Choke
1	1.5-5.5 kW	Built-in
2	7.5-15 kW	
3	18.5-30 kW	
4	37-55 kW	
5	75-110 kW	
6	132-160 kW	

DC version available under request.



MULTIPLE CONFIGURATIONS

- Stand alone IP20
- External Heatsink
- Case IP54
- Turnkey Cabinet solution



SERIAL LINE

The RS485 serial line is incorporated as standard across the range to enable peer-to-peer or multidrop connections using Modbus RTU protocol.

ADV200 SP FOR SOLAR PUMP



INTEGRATED KEYPAD

- > 4 lines display for 21 characters
- > Clear alphanumeric text
- > Full information of any parameters
- > Fast Navigating Keys
- > Key for displaying the last 10 parameters that have been changed
- > DISP key for rapid display of operating parameters
- > Upload - Download and storage of 5 complete sets of drive parameters
- > Remotable up to 10 meters.

OPT CARDS

ADV200 SP manages up to 3 option cards:

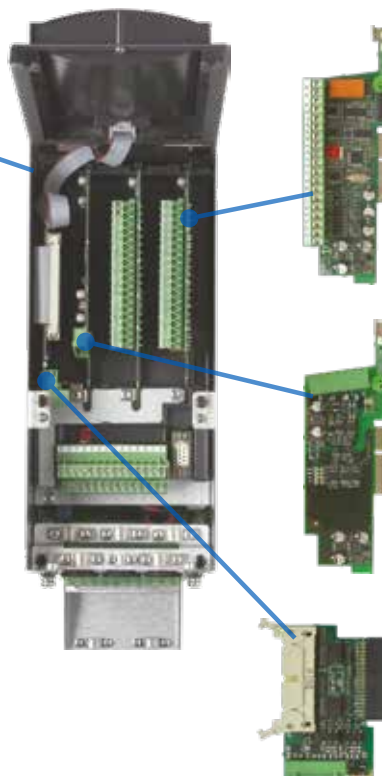

> I/O expansions

- **EXP-IO-D6A4R1-ADV:** 4 DI/ 2 DO/ 2 AI / 2 AO / 2 NO
- **EXP-IO-D5R8-ADV:** 4 DI / 1 DO / 8 NO
- **EXP-IO-SENS-1000-ADV:** 3 AI/ 2 AO signals from PT1000, NI1000, 0-10V, 0/4...20mA, KTY84, PTC (motor overtemperature control only)
- **EXP-IO-SENS-100-ADV:** 3 AI/ 2 AO signals from PT100, 0-10V, 0/4...20mA, KTY84, PTC (motor overtemperature control only)

> Fieldbus interface



> Safety Card

- PL=e under EN ISO 13849-1
- SIL 3 under IEC EN61508
IEC EN61800-5-2

+24 VDC

Regulation card external power supply

CONNECTIONS

ADV200 SP for solar pump applications is suitable for both isolated and dual-supply systems (grid-connected or with secondary power source):

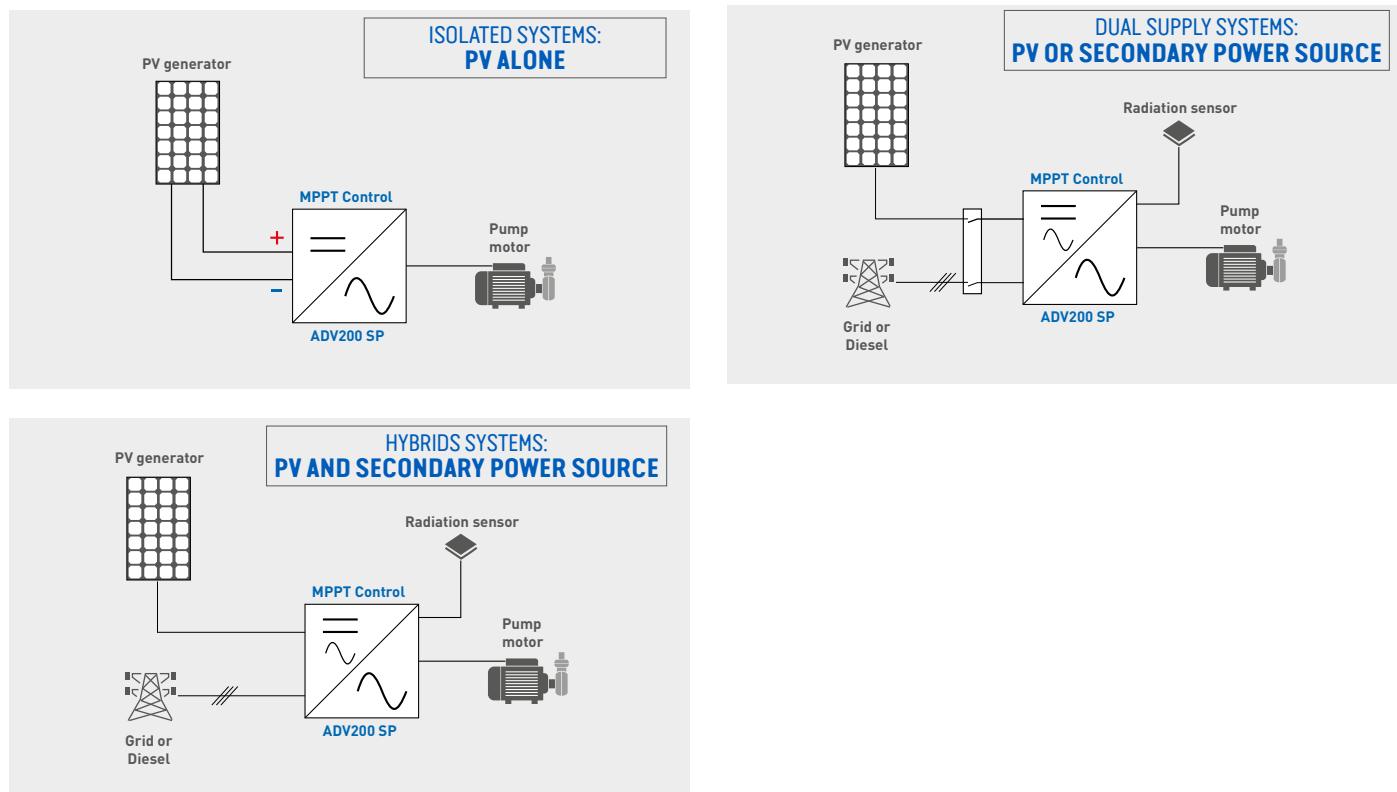

STANDARD CONNECTION

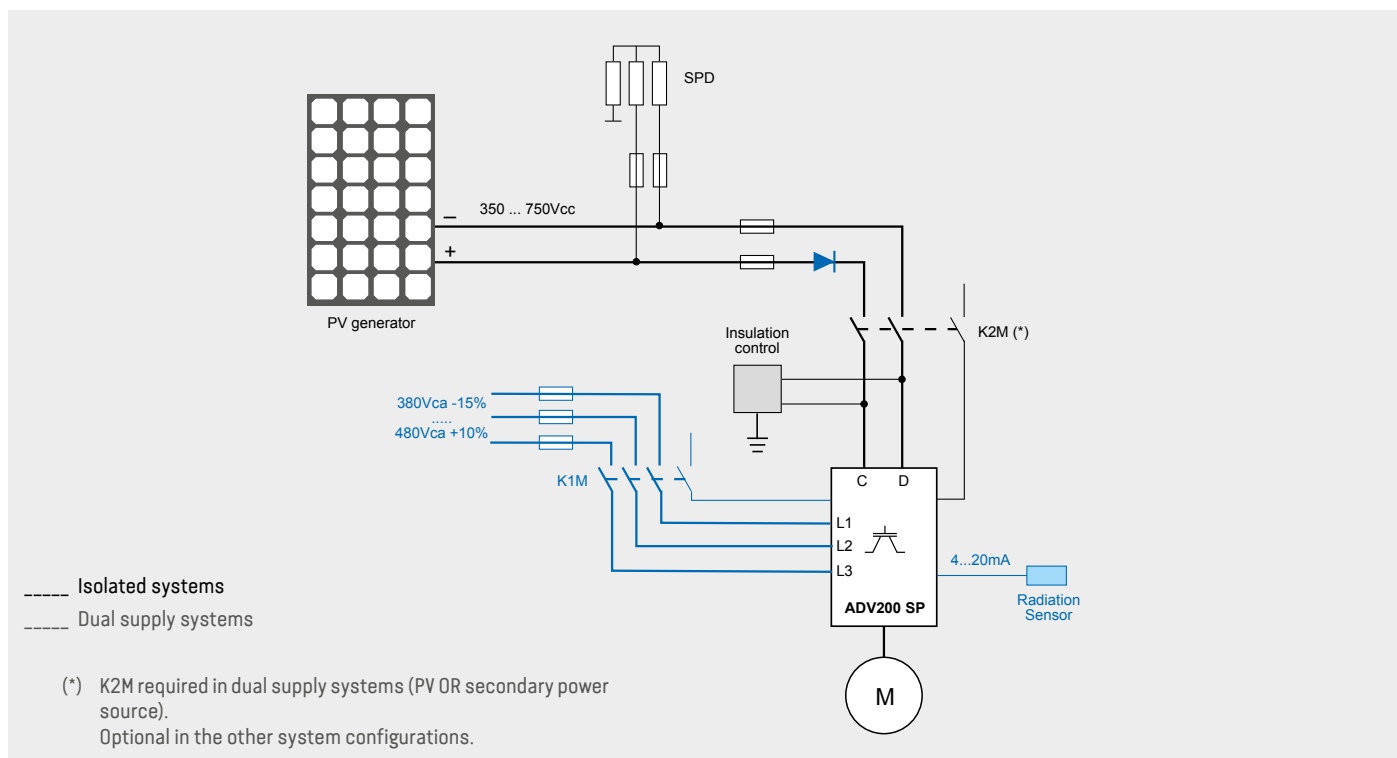

INPUT / OUTPUT DATA

Values for Low Duty overload.

The parameters can be set to heavy duty mode; please refer to the manual for HD electrical data.

Sizes ADP200-SP-	Input data			Output data			
	IN DC input current ⁽¹⁾	IN AC input current ⁽²⁾	Inverter output	Pn mot		I _{2N} Rated output current	
				@ 540 Vdc @ 400 Vac	@ 650 Vdc @ 460 Vac	@ 540 Vdc @ 400 Vac	@ 650 Vdc @ 460 Vac
[Arms]	[Arms]	[KVA]	[kW]	[Hp]	[A]	[A]	
1015	4.7	3.7	3.0	1.5	2	4.3	3.9
1022	6.2	4.9	4.0	2.2	3	5.8	5.2
1030	8.1	6.5	5.3	3	5	7.6	6.8
1040	10	8.1	6.6	4	5	9.5	8.6
1055	14	11.1	9	5.5	7.5	13	11.7
2075	18	14.0	11.4	7.5	10	16.5	14.9
2110	25	19.6	15.9	11	15	23	20.7
2150	33	26.4	21.5	15	20	31	27.9
3185	40	32.3	26.3	18.5	25	38	34.2
3220	48	39	32	22	30	46	41.4
3300	65	53	43	30	40	62	55.8
4370	80	64	52	37	50	75	67.5
4450	90	74	60	45	60	87	78.3
4550	125	89	73	55	75	105	94.5
5750	175	143	104	75	100	150	135
5900	210	171	125	90	125	180	162
51100	240	200	145	110	150	210	189
61320	290	238	173	132	175	250	225
61600	350	285	208	160	200	300	270

⁽¹⁾ Motor cos phi 0.9 @ 540 Vdc

⁽²⁾ Motor cos phi 0.9 @ 400 Vac

DIMENSIONS AND WEIGHTS

Sizes	Dimensions: Width x Height x Depth		Weight	
	mm	inches	kg	lbs
ADP200-SP-1...	118 x 322 x 235	4.65 x 12.7 x 9.25	5.8	12.8
ADV200-SP-2...	150 x 392 x 250	5.91 x 15.43 x 9.84	10.2	22.5
ADP200-SP-3...	180 x 517 x 250	7.09 x 20.35 x 9.84	16.4 (3220=22kg)	36.2 (3220=48.5 lbs)
ADP200-SP-4...	268 x 616 x 270	10.55 x 24.25 x 10.63	32	70.6
ADP200-SP-5...	311 x 767 x 325	12.24 x 30.19 x 12.8	60	132.3
ADP200-SP-6...	422 x 878 x 360	16.61 x 34.6 x 14.2	90	198.4

DRIVE TYPE DESIGNATION AND MODELS

DRIVE TYPE DESIGNATION

ADV200-SP-X XXX -XXX-X-SI

EXP-SFTy-ADV safety card	SI = included, [empty] = not included		
Rated voltage:	4 = 400-480 VAC, 3ph / 50-60 Hz		
Software	X = standard		
Braking unit:	X = not included, B = included		
Keypad:	X = not included, K = included		
Drive power, in kW:	015 = 1.5 kW 022 = 2.2 kW 030 = 3.0 kW 040 = 4.0 kW 055 = 5.5 kW 075 = 7.5 kW 110 = 11kW	150 = 15kW 185 = 18.5kW 220 = 22.0 kW 300 = 30.0 kW 370 = 37.0 kW 450 = 45.0 kW 550 = 55.0 kW	750 = 75.0 kW 900 = 90.0 kW 1100 = 110.0 kW 1320 = 132.0 kW 1600 = 160.0 kW
Mechanical dimensions of the drive:	1 = size 1 2 = size 2	3 = size 3 4 = size 4	5 = size 5 6 = size 6
Inverter ADV200 Solar Pump series			

ADV200-SP-3 030 -KXX-4

Rated voltage:	4 = 400 VAC, 3ph / 50 Hz
Software	X = Standard
Braking unit:	X = not included
Keypad:	K = included
Drive power, in kW:	030 = 3.0 kW
Mechanical dimensions of the drive:	3 = size 3
Inverter ADV200 Solar Pump series	

DRIVE MODELS & CODES

Model	Code	Pn@ 400 Vac (LD)	Configuration
ADV200-SP-1015-KBX-4	S9001SP	1.5 kW	Internal Braking Unit – Built-in DC choke
ADV200-SP-1022-KBX-4	S9002SP	2.2 kW	Internal Braking Unit – Built-in DC choke
ADV200-SP-1030-KBX-4	S9003SP	3.0 kW	Internal Braking Unit – Built-in DC choke
ADV200-SP-1040-KBX-4	S9004SP	4.0 kW	Internal Braking Unit – Built-in DC choke
ADV200-SP-1055-KBX-4	S9005SP	5.5 kW	Internal Braking Unit – Built-in DC choke
ADV200-SP-2075-KBX-4	S9006SP	7.5 kW	Internal Braking Unit – Built-in DC choke
ADV200-SP-2110-KBX-4	S9007SP	11 kW	Internal Braking Unit – Built-in DC choke
ADV200-SP-2150-KBX-4	S9008SP	15 kW	Internal Braking Unit – Built-in DC choke
ADV200-SP-3185-KBX-4	S9009SP	18.5 kW	Internal Braking Unit – Built-in DC choke
ADV200-SP-3220-KBX-4	S9010SP	22 kW	Internal Braking Unit – Built-in DC choke
ADV200-SP-3300-KBX-4	S9011SP	30 kW	Internal Braking Unit – Built-in DC choke
ADV200-SP-4370-KXX-4	S9012SP	37 kW	Built-in DC choke
ADV200-SP-4450-KXX-4	S9014SP	45 kW	Built-in DC choke
ADV200-SP-4550-KXX-4	S9016SP	55 kW	Built-in DC choke
ADV200-SP-5750-KXX-4	S9018SP	75 kW	Built-in DC choke
ADV200-SP-5900-KXX-4	S9020SP	90 kW	Built-in DC choke
ADV200-SP-51100-KXX-4	S9021SP	110 kW	Built-in DC choke
ADV200-SP-61320-KXX-4	S9022SP	132 kW	Built-in DC choke
ADV200 SP-61600-KXX-4	S9023SP	160 kW	Built-in DC choke

Higher powers under request.

SOFTWARE

GF-eXpress PROGRAMMING SOFTWARE

Applications

- > Configuring parameters of Gefran devices (Instruments, Drives, Sensors)
- > Tuning control parameters with on-line tests and trends
- > Managing parameter archive for multiple configuration.

Features

- > Guided product selection
- > Simplified settings
- > Multiple languages
- > Parameter printout
- > Creation and storage of recipes
- > Network autoscan
- > Oscilloscope

GF_eXpress software configures the parameters of the automation components, drives and sensors in the Gefran catalogue.

The graphic interface makes selecting and configuring parameters easy and intuitive. Devices are grouped according to product type and functions.

Products are searched by means of a context search and a display of product photos.

This provides a single device library for all Gefran products.

Complete configuration information for every device is given in XML format to facilitate expansion of the catalogue and parameters.

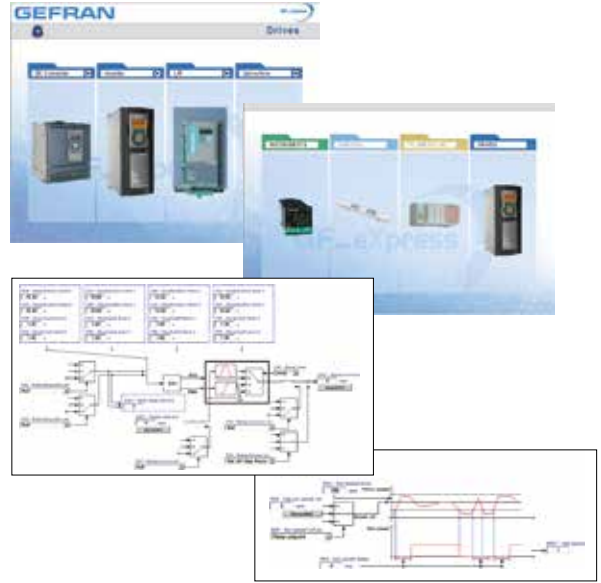

SOFTSCOPE

SoftScope is a software oscilloscope with synchronous sampling (buffered with a minimum sampling time of 1ms).

With SoftScope, the user can easily and quickly display a number of specific variables, such as commissioning variables, variables for testing performance levels achieved or for tuning control loops, etc.

SoftScope can be used to define the following parameters:

- > Trigger conditions (e.g. climbing leading edge of a specific signal)
- > Recording quality (a multiple of the basic clock at 1ms)
- > Recording duration period
- > System sizes to be recorded.



GF_CONNECT

GF_Connect is Gefran's answer to customers who require connectivity and communication services.

Regardless of the type of installation (isolated or dual-supply), with GF_Connect you can make use of advanced connectivity services that allow you to remain connected to your system at all times:

- > Remote access to network or serial connected devices
- > Via tool on secure PC connection with tunnel VPN
- > Access from development environment or configuration tool (also for 485 devices)
- > Email delivery upon event
- > Pdf reports
- > Integrated web server
- > Gateway between various protocols
- > 3G module.



Dimensions: Width x Height x Depth		Weight
mm (inches)		kg (lbs)
45 x 134 x 102 (1.77 x 5.27 x 4.01)		0.6 (1.32)

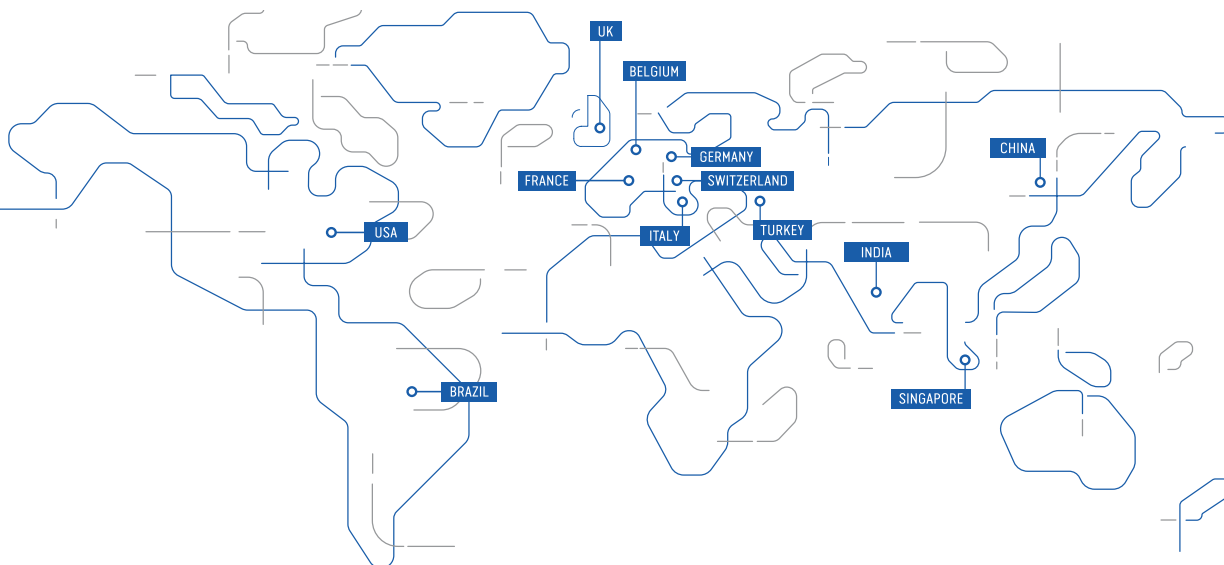

GEFRAN DEUTSCHLAND GmbH

Philipp-Reis-Straße 9a
D-63500
Seligenstadt
Ph. +49 (0) 61828090
Fax +49 (0) 6182809222
vertrieb@gefran.de

SIEI AREG - GERMANY

Gottlieb-Daimler Strasse 17/3
D-74385
Pleidelsheim
Ph. +49 (0) 7144 897360
Fax +49 (0) 7144 8973697
info@sieiareg.de

SENSORMATE AG

Steigweg 8,
CH-8355 Aadorf, Switzerland
Ph. +41(0)52-2421818
Fax +41(0)52-3661884
http://www.sensormate.ch

GEFRAN FRANCE SA

PARC TECHNOLAND
Bâtiment K - ZI Champ Dolin
3 Allée des Abruzzes
69800 Saint-Priest
Ph. +33 (0) 478770300
Fax +33 (0) 478770320
commercial@gefran.fr

GEFRAN BENELUX NV

ENA 23 Zone 3, nr. 3910
Lammerdries-Zuid 14A
B-2250 OLEN
Ph. +32 (0) 14248181
Fax +32 (0) 14248180
info@gefran.be

GEFRAN UK Ltd

Clarendon Court
Winwick Quay
Warrington
WA2 8QP
Ph. +44 (0) 8452 604555
Fax +44 (0) 8452 604556
sales@gefran.co.uk

GEFRAN MIDDLE EAST

Yeşilköy Mah. Atatürk Cad.
EGS Business Park
No:12 B1 Blok K:12 D:393
Bakırköy/İstanbul/TÜRKİYE
Ph. +90 212 465 91 21
Fax +90 212 465 91 22
info@gefran.com.tr

GEFRAN SIEI

Drives Technology Co., Ltd
No. 1285, Beihe Road, Jiading
District, Shanghai,
China 201807
Ph. +86 21 69169898
Fax +86 21 69169333
info@gefran.com.cn

GEFRAN SIEI - ASIA

31 Ubi Road 1
#02-07,
Aztech Building,
Singapore 408694
Ph. +65 6 8418300
Fax +65 6 7428300
info@gefran.com.sg

GEFRAN INDIA

Survey No. 191/A/1,
Chinchwad Station Road,
Chinchwad,
Pune -411033, Maharashtra
Ph. +91 20 6614 6500
Fax +91 20 6614 6501
gefran.india@gefran.in

GEFRAN Inc.

400 Willow Street
North Andover, MA
01845 USA
Toll Free 1-888-888-4474
Fax +1 (617) 340 2761
info.us@gefran.com

GEFRAN BRASIL ELETROELETRÔNICA

Avenida Dr. Altino Arantes,
377 Vila Clementino
04042-032 SÃO PAULO - SP
Ph. +55 (0) 1155851133
Fax +55 (0) 1132974012
comercial@gefran.com.br

GEFRAN HEADQUARTER

Via Sebina, 74
25050 PROVAGLIO D'ISEO (BS) ITALY
Ph. +39 030988881
Fax +39 0309839063

GEFRAN DRIVES AND MOTION S.R.L.

Via Carducci, 24
21040 GERENZANO (VA) ITALY
Ph. +39 02967601
Fax +39 029682653
info.motion@gefran.com
Technical Assistance:
technohelp@gefran.com
Customer Service
salesmotion@gefran.com



www.gefran.com

GEFRAN

BEYOND TECHNOLOGY