

PRODUCT DATA SHEET



PRODUCT CODE

MA7000DSC

RANGE

Mada

DESCRIPTION

Mada Basin Unit 700 Soft Clay

WEBSITE LINK [Click Here](#)

CATEGORY	Furniture
WARRANTY DETAILS	10 Years
COLOUR	Soft Clay
FINISH APPLICATION	Lacquered
PRIMARY MATERIAL	Steel
INSTALL TYPE	Wall Mounted
PRODUCT WIDTH MM	688
PRODUCT HEIGHT MM	360
PRODUCT DEPTH MM	355
PRODUCT NET WEIGHT KG	16
STANDARDS	EN 14749

COLOUR CODE / REFERENCE	NCS 3060Y70R
DRAWER BOX	Steel
DRAWER RUNNERS	EMUCA - 3170935
DRAWER EXTENSION	Full extension
DRAWER ADJUSTMENT	2
WALL HANGERS	Yes
ADJUSTABLE FEET	No
DRAWER CAPACITY	30 KGS
DRAWER OPERATION	Soft close

TECHNICAL DIMENSIONS

Dimensions in mm unless otherwise specified.

Tolerances (per material type) apply.

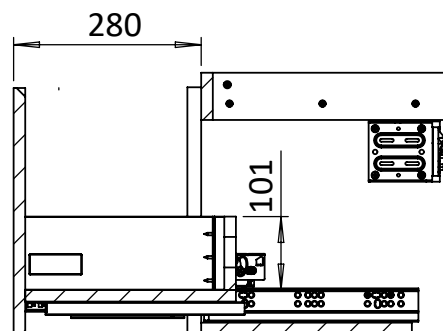
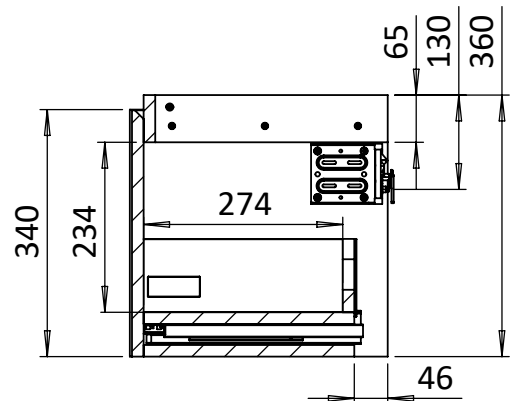
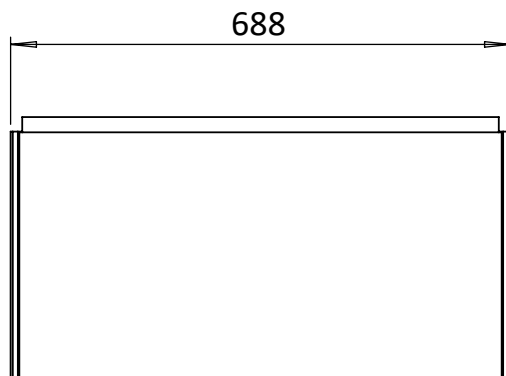
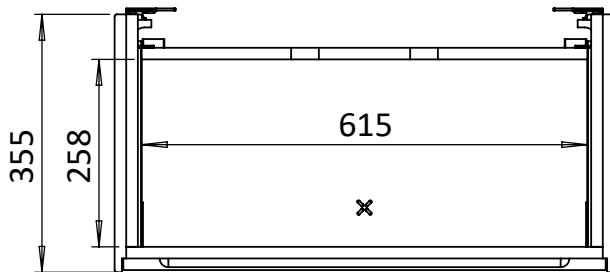

SPARES LIST

Only the parts labelled are available as spares.

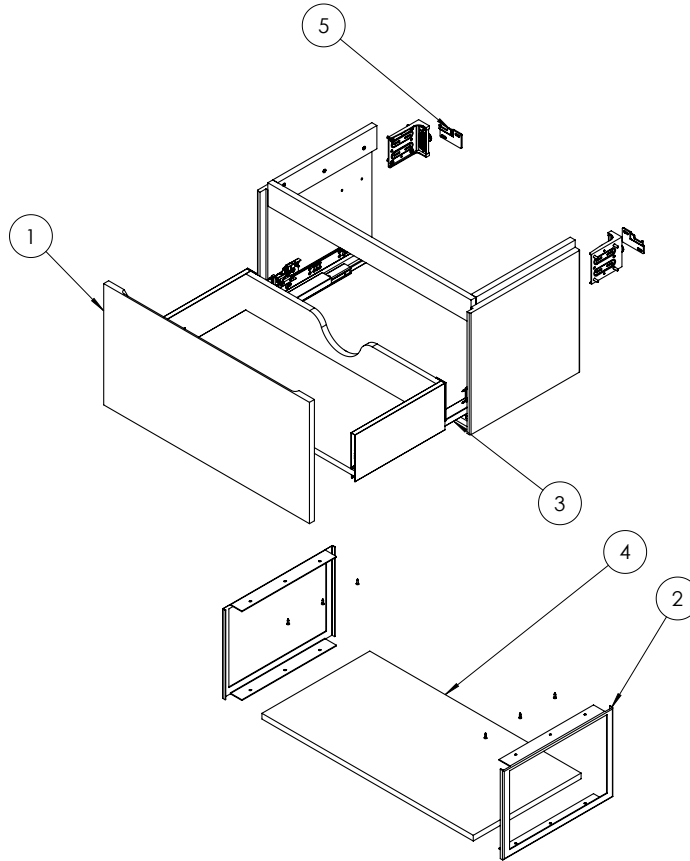

NUMBER	PART CODE	DESCRIPTION
1	DF_MA7000DIB	Mada Drawer Front only for MA7000DIB
	DF_MA7000DSC	Mada Drawer Front only for MA7000DSC
	DF_MA7000DSGR	Mada Drawer Front only for MA7000DSGR
	DF_MA7000DWG	Mada Drawer Front only for MA7000DWG
2	FRAMEMADAIB	Mada Leg Metallic X1 all units Colour Indigo Blue
	FRAMEMADASC	Mada Leg Metallic X1 all units Colour Soft Clay
	FRAMEMADASGR	Mada Leg Metallic X1 all units Colour Sage Green
	FRAMEMADAWG	Mada Leg Metallic X1 all units Colour White
3	RUNNERSMADA	Mada set of Drawer Runners x2 All Units
4	SHELFMADA70	Shelf for MA7000
5	WBRACKETSCANVASS	Wall Brackets x2
	SCREPAIR	Touch Up Kit Soft Clay
	BMREPAIR	Touch Up Kit Black Matt
	WGREPAIR	Touch Up Kit Gloss White
	SGREPAIR	Touch Up Kit Storm Grey