

PRODUCT DATA SHEET



PRODUCT CODE

MA6000DIB

RANGE

Mada

DESCRIPTION

Mada Basin Unit 600 Deep Indigo Blue

WEBSITE LINK [Click Here](#)

CATEGORY	Furniture
WARRANTY DETAILS	10 Years
COLOUR	Deep Indigo Blue
FINISH APPLICATION	Lacquered
PRIMARY MATERIAL	Steel
INSTALL TYPE	Wall Mounted
PRODUCT WIDTH MM	588
PRODUCT HEIGHT MM	360
PRODUCT DEPTH MM	355
PRODUCT NET WEIGHT KG	14
STANDARDS	EN 14749

COLOUR CODE / REFERENCE	NCS S8010R90B
DRAWER BOX	Steel
DRAWER RUNNERS	EMUCA - 3170935
DRAWER EXTENSION	Full extension
DRAWER ADJUSTMENT	2
WALL HANGERS	Yes
ADJUSTABLE FEET	No
DRAWER CAPACITY	30 KGS
DRAWER OPERATION	Soft close

TECHNICAL DIMENSIONS

Dimensions in mm unless otherwise specified.

Tolerances (per material type) apply.

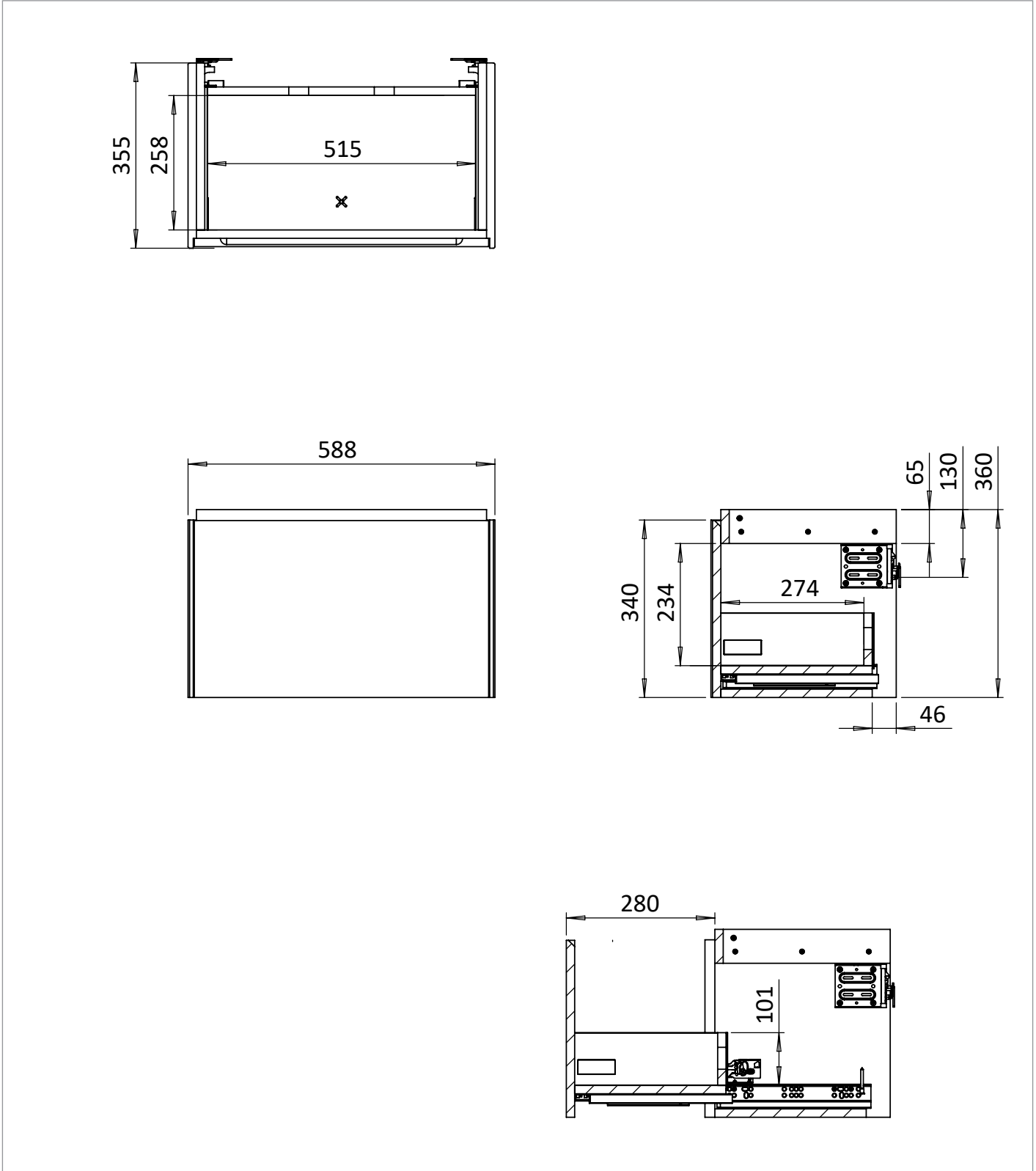

SPARES LIST

Only the parts labelled are available as spares.

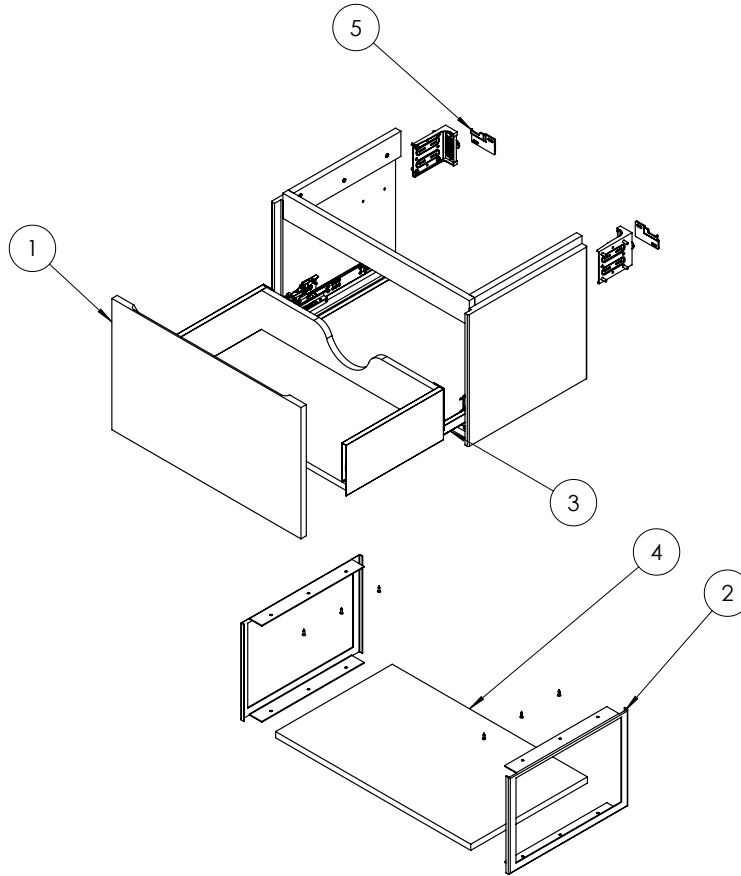

NUMBER	PART CODE	DESCRIPTION
1	DF_MA6000DIB	Mada Drawer Front only for MA6000DIB
	DF_MA6000DSC	Mada Drawer Front only for MA6000DSC
	DF_MA6000DSGR	Mada Drawer Front only for MA6000DSGR
	DF_MA6000DWG	Mada Drawer Front only for MA6000DWG
2	FRAMEMADAIB	Mada Leg Metallic X1 all units Colour Indigo Blue
	FRAMEMADASC	Mada Leg Metallic X1 all units Colour Soft Clay
	FRAMEMADASGR	Mada Leg Metallic X1 all units Colour Sage Green
	FRAMEMADAWG	Mada Leg Metallic X1 all units Colour White
3	RUNNERSMADA	Mada set of Drawer Runners x2 All Units
4	SHELFMADA60	Shelf for MA6000
5	WBRACKETSCANVASS	Wall Brackets x2
	SCREPAIR	Touch Up Kit Soft Clay
	BMREPAIR	Touch Up Kit Black Matt
	WGREPAIR	Touch Up Kit Gloss White
	SGREPAIR	Touch Up Kit Storm Grey