

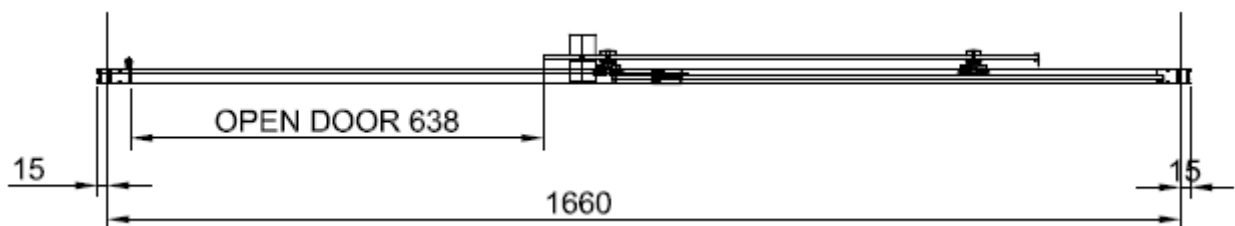

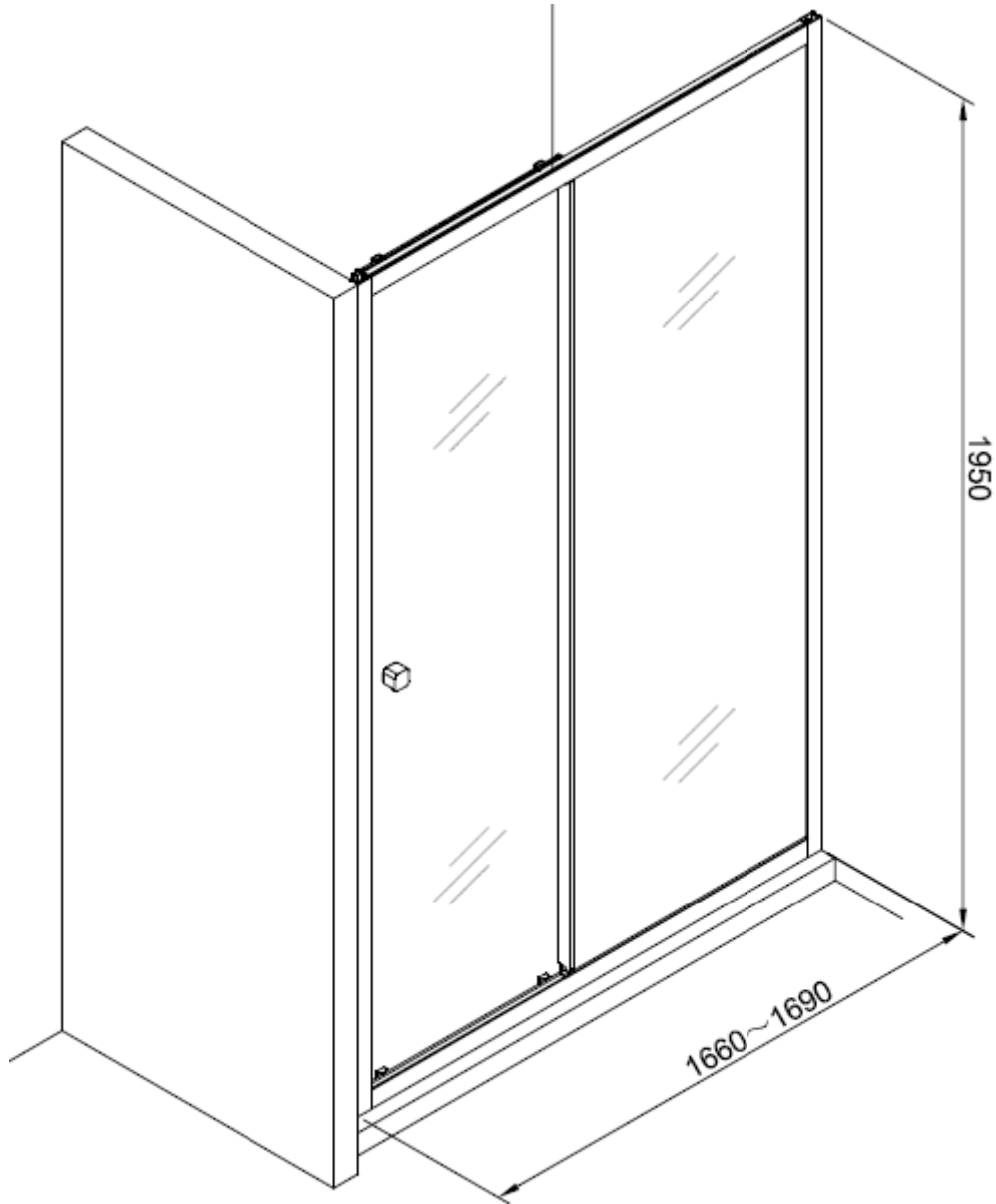

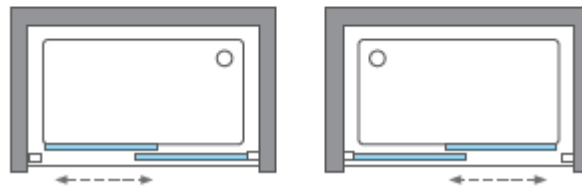

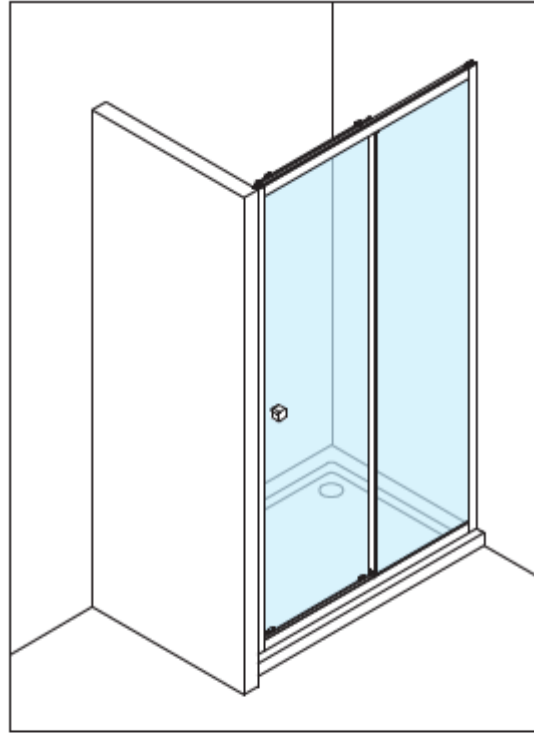











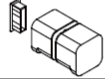
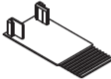

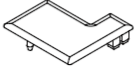
Measurements in millimetres mm
Information updated January 2020
Tel 0345 873 8840

crosswater[™]

CLEAR 6 SLIDING DOOR
CASLSC1700



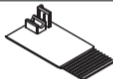
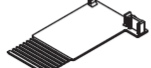

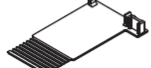
A	 M4 *40mm Screw x 6	I	 Waterproof strip x 1	AA	 M4 *20mm Screw x 1
B	 M4 *30mm Screw x 4	J	 Waterproof strip x 1	AB	 Adjustment block x 1
C	 M4 *20mm Screw x 4	K	 Handle x 1	AC	 Top Cap x 1
D	 Wall Plug x 6	L	 Sleeve x 1	AD	 Top Cap(LH) x 1
E	 Cover x 3	M	 Spanner x 1	AE	 Top Cap(RH) x 1
F	 Filler x 2	N	 Top Cap(LH) x 1	AF	 Filler x 2
G	 Cover x 4	O	 Top Cap(RH) x 1		
H	 Waterproof strip x 1	P	 Top Cap(LH) x 1	Q	 Top Cap(RH) x 1

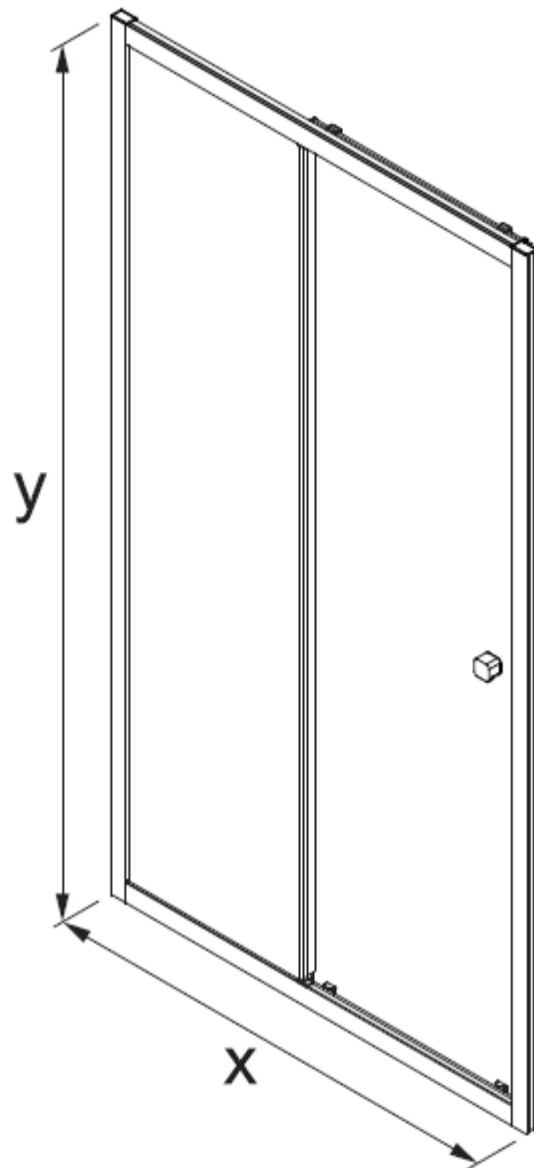

Model	X (mm)	y (mm)
CASLSC1000	960~990	1950
CASLSC1100	1060~1090	1950
CASLSC1200	1160~1190	1950
CASLBC1200	1160~1190	1950
CASLSC1300	1260~1290	1950
CASLSC1400	1360~1390	1950
CASLBC1400	1360~1390	1950
CASLSC1500	1460~1490	1950
CASLBC1500	1460~1490	1950
CASLSC1600	1560~1590	1950
CASLSC1700	1660~1690	1950