

SL.1509 Kit Size 1500mm x 900mm

Easy to install, preformed wetroom tray with integrated steel drain which is sealed with a watertight gasket. The preformed rigid tray is waterproof and has a cementitious top layer for high compression strength. Panels are available as Brushed Stainless Steel or durable PVD coated colours. Supplied with a high quality, flexible waterproofing membrane.



See next page for technical information

				
Steel Tile Insert Kit Order Ref	Black Tile Insert Kit Order Ref	Brass Tile Insert Kit Order Ref	Nickel Tile Insert Kit Order Ref	Bronze Tile Insert Kit Order Ref
				
Steel Panel Kit Order Ref	Black Panel Kit Order Ref	Brass Panel Kit Order Ref	Nickel Panel Kit Order Ref	Bronze Panel Kit Order Ref
SL.1509SS	SL.1509BL	SL.1509BS	SL.1509NI	SL.1509BZ

Specification

MATERIAL Extruded polystyrene (XPS) with cement coating, stainless steel, PP (Plastic)	GRATING Brushed Stainless Steel. PVD Coated colours	CAPACITY 36 l/min
USAGE Wetroom kit with Linear drain	MEMBRANE Liquid membrane and Sheet membrane	FLOORING Minimum Tile Thickness 8mm
WATER SEAL 50mm	REMOVABLE TRAP FOR CLEANING Yes	BOARD HEIGHT 30mm

SL.1509 - Wetroom Kit

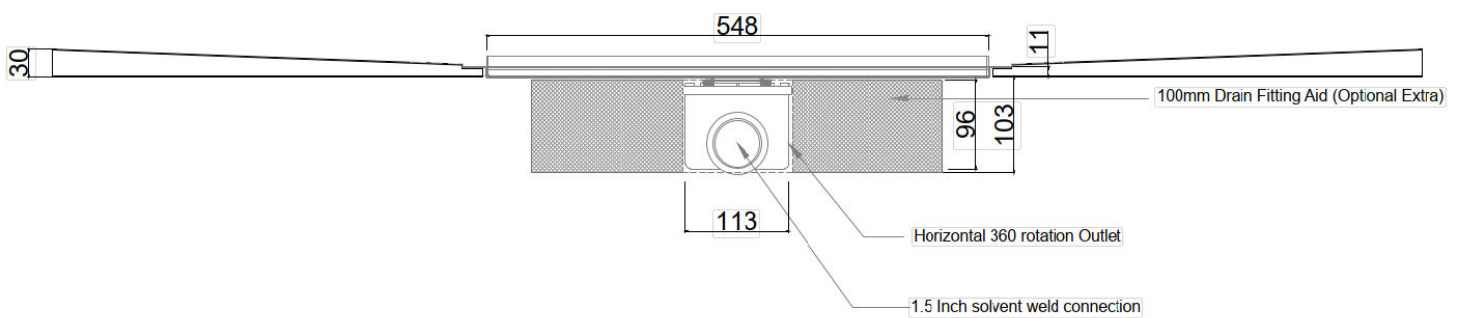
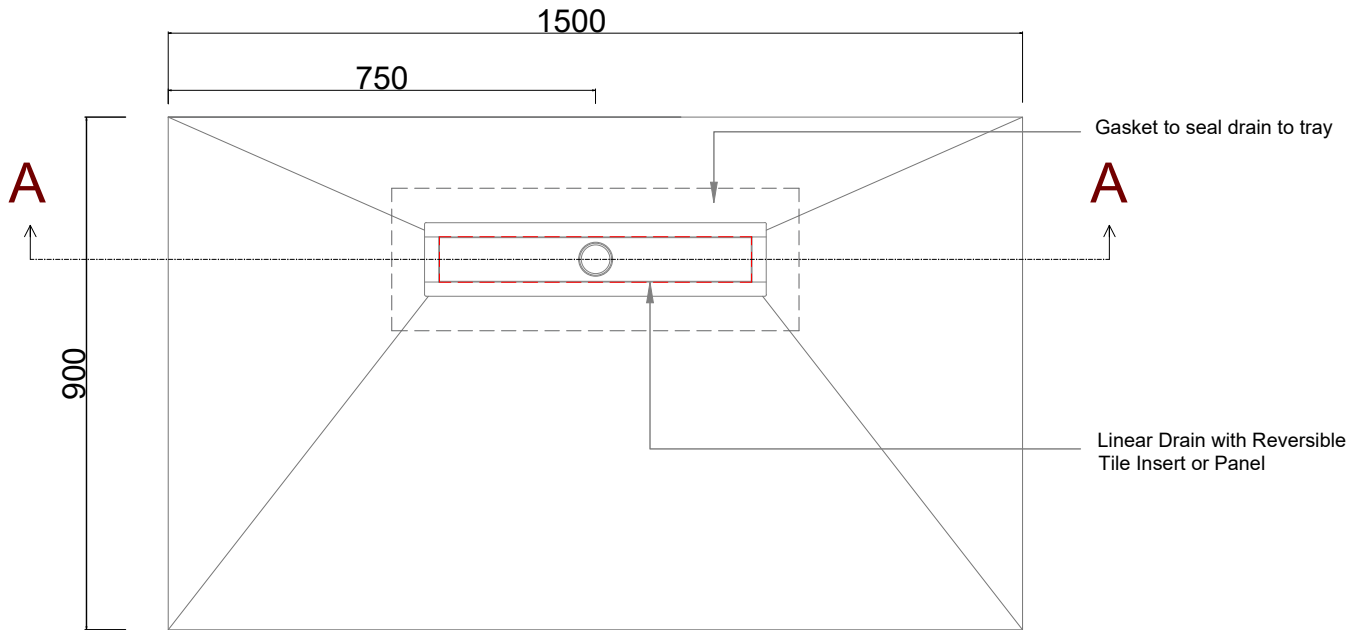

WMVS30K - Waterproofing Kit

Easy application paint on liquid membrane for waterproofing wet rooms and bathrooms

Contains 3kg liquid membrane, 25m reinforcement trap and 1l primer.



Specifications

Material: acrylic polymers, plasticizer, water and preservative

Coverage: 1.75m²

Can be applied to: Wood, concrete, metal, plastic, plaster, light clinker concrete, screed, lightweight concrete, stucco, gypsum floors, calcium, silicate plates and various approved wet room plaster boards, gypsum fibre, cement and polystyrene.

Drying time: 1st layer 1-2 hours at 18-20°C. 2nd layer approx 12 hours at 18-20°C.
Drying times will vary depending on temperature, ventilation and substrate.

Application method: Paint brush and roller.

Notes: Room must be primed with Primer 54 included before applying liquid membrane. All major joints must be reinforced using LIP reinforcement tape included. Ensure all areas are dry after each stage before proceeding i.e. Priming, 1st coat and 2nd coat before proceeding. No one can access the area whilst membrane is drying. Once 2nd coat is completely dry, cover membrane with a suitable protective sheet / board until tiled. If a heater is required, do not place too close to the membrane.

Refer to installation instructions and safety data sheet for more information.