

Instructions for the installation, use and maintenance of kitchen stainless steel sinks

Sinks' material: austenitic stainless steel AISI 304 - 18/10
EN 13310
(kitchen sinks for domestic use, functional features and tests' methods)

INSTALLATION

Standard and flat (3 mm bended) edge

Before making any cut-out on the worktop, we suggest to verify and lay the sink on the worktop itself and/or on the cabinets in order to verify that the external dimensions of the bowls are compatible with the cabinets themselves, in order to avoid making cut-outs for sinks that cannot be installed.

We also recommend to verify the possibility to install taps and other accessories, by checking the place they need and the place that remains. Also verify the possibility to accede to the water main tap under the sink, and that the positioning of the siphon is feasible. To install the sink, one must make a cut-out on the worktop.

Once the cut-out is made, one must position the gasket around the perimeter of the hole. Before installing the sink, please position the waste-fitting and overflow pipe (when present); when available, also the command of the automatic waste-fitting must be installed at this stage.

Make sure that the external edge of the sink is positioned upon the gasket, so as to create a barrier preventing the infiltration of water and dirt between sink and worktop.

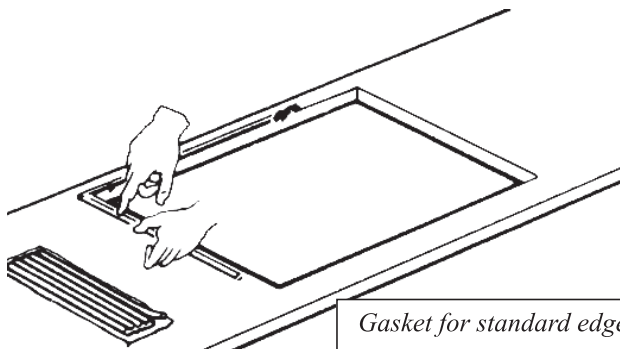

Gasket for standard edge

After having positioned the sink on the worktop, fix it by tightening the screws of the brackets which are provided (the screws must be tightened just enough to have the brackets clamp down on the worktop).

Afterwards, remove the excess gasket with a cutter. The taps can be installed before or after the positioning of the sink.

After having installed the sink, connect the waste-fitting with the siphon. Check the water-tightness by closing the basket of the waste-fitting, open the tap and wait until the water level reaches the overflow; shut the tap, and wait several minutes, verifying that the water does not drain away. Empty the sink.

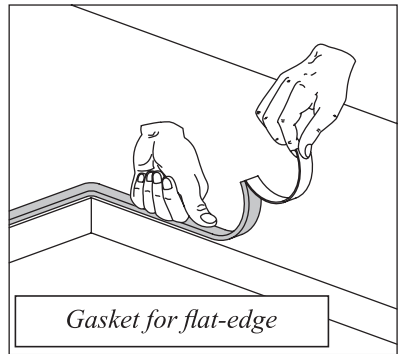

Flush-mount edge

For a correct installation of the flush-mount sinks, please follow strictly the technical sheet provided with the sink; only qualified personnel should make the cut-out, and a computer-operated machine is necessary. It is advisable to accurately clean the seat for the cut-out, and to insert the gasket which is provided, between the sink and the worktop, so as to avoid possible water infiltration into the worktop or the cabinets.

The work must be carried out by experienced personnel.

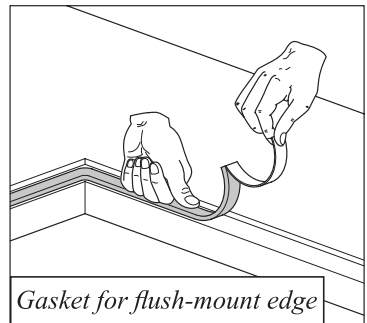
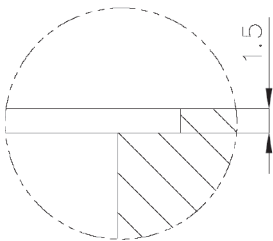

Do not use electric screwdrivers to tighten the brackets.

The tightening torque must not exceed 60 N/cm.

It is advisable to install the flush-mount sinks on hydro repellent materials, in order to avoid eventual deformations of the material itself.

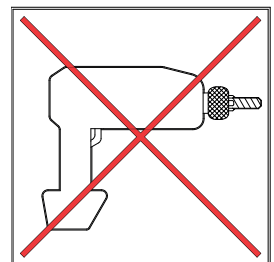

Undermount installation

For the undermount sinks, proceed as for the normal built-in sinks.

Make a cut-out on the worktop following the template and/or instructions provided with the sink. Before installing the sink, seal with silicone. Tighten the brackets.

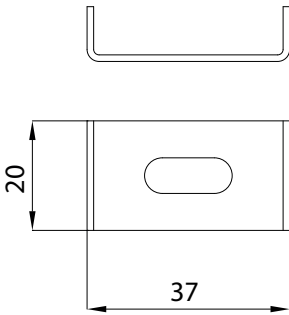

*Fixing bracket for
undermount sinks*

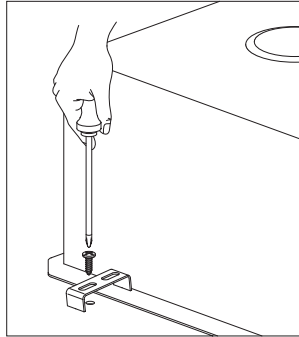

*Fixing bracket
system*

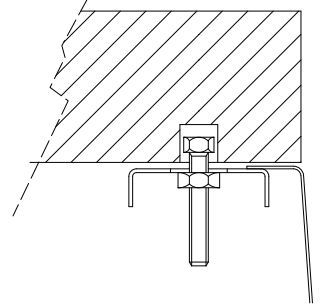

lateral section

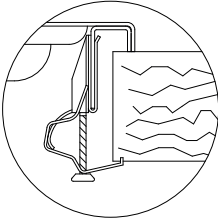
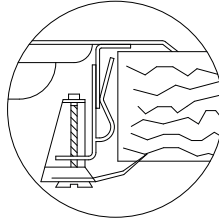
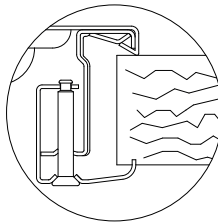
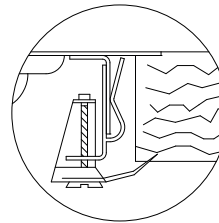
Fixing system			
fixed bracket	FR	fixed bracket	FI
			
sliding bracket	S	fixed bracket	FI
			

CARE and MAINTENANCE

The Foster collections are the result of a huge experience, and a careful development to meet at best the necessities of the users', so as to obtain a high-quality product. It is important, however, to inform our customers that one must also use the product correctly and maintain it properly.

As all materials, also stainless steel can become dirty; by following very simple instructions, one can bring the sink back to its original shine.

For everyday's maintenance, wash the sink with water and soap, or a product to wash the dishes, rinse abundantly, and do not forget to dry. For more obstinate dirt, the STEEL CLEAN line of products, proposed by Foster and available at all our Assistance Centres throughout the Country, is very suitable to eliminate it without much fuss. Take care to avoid shocks, to drop heavy objects on the sink, and not to use utensils which can scratch the surface when handling tools may be appropriate to protect the steel surfaces, for example with an insulating pad. Also avoid the contact with chemicals, cleaners for metal, products to take off paint, metal brushes. Do not leave for long stretches of time tomato residues on the sink, as well as milk, and coffee on the sink; also, avoid long contacts with metal drums with wet bottoms, and iron objects in general. Please note that the long contact of any of the above-mentioned substances with the sink can originate a corrosive attack of electrochemical nature, even though very mild.



ATTENTION

- *Rinse accurately after use, and dry with a clean cloth*
- *To clean the sink, normal detergent can be used, as long as not containing hydrochloric Acid (commercial Muriatic acid) or its derivatives*
- *In case of persistent stains, try to clean with some warm vinegar or with specific products for Stainless steel (the specific line of products "Foster Steel clean" is suggested)*
- *Do not use steel sponges to clean the sink, or any other item that could scratch the surface*
- *Avoid using muriatic acid or bleach*
- *Do not leave iron objects on the sink for long*
- *Please keep this instructions leaflet*

Foster

via M.S. Ottone, n. 18/20 - 42041 Brescello (RE) - Italia