

PRODUCT DATA SHEET



PRODUCT CODE

RANGE

Clear 6

DESCRIPTION

Clear 6 Quadrant Single Door 900 Box A
Brushed Brass

CATEGORY	Showering
WARRANTY DETAILS	Lifetime
COLOUR	Brushed Brass
FINISH APPLICATION	Anodised
PRIMARY MATERIAL	Glass
INSTALL TYPE	Wall Mounted
PRODUCT WIDTH MM	870
PRODUCT HEIGHT MM	1950
PRODUCT LENGTH MM	870
PRODUCT NET WEIGHT KG	22
STANDARDS	EN14428

HANDING SHOWERING	Universal
GLASS THICKNESS	6mm
EASY CLEAN	Yes
MAGNETIC DOOR STRIPS	No
POWER SHOWER PROOF	Yes
NUMBER OF DOORS	1
SOFT CLOSING DOORS	No
SAFETY GLASS	Yes
REMOVABLE SEALS	Yes
QUICK RELEASE ROLLERS	Yes
WET ROOM COMPATIBLE	Yes
DOOR A INFORMATION	Quadrant door
DOOR ADJUSTMENT	870-885mm

TECHNICAL DIMENSIONS

Dimensions in mm unless otherwise specified.

Tolerances (per material type) apply.

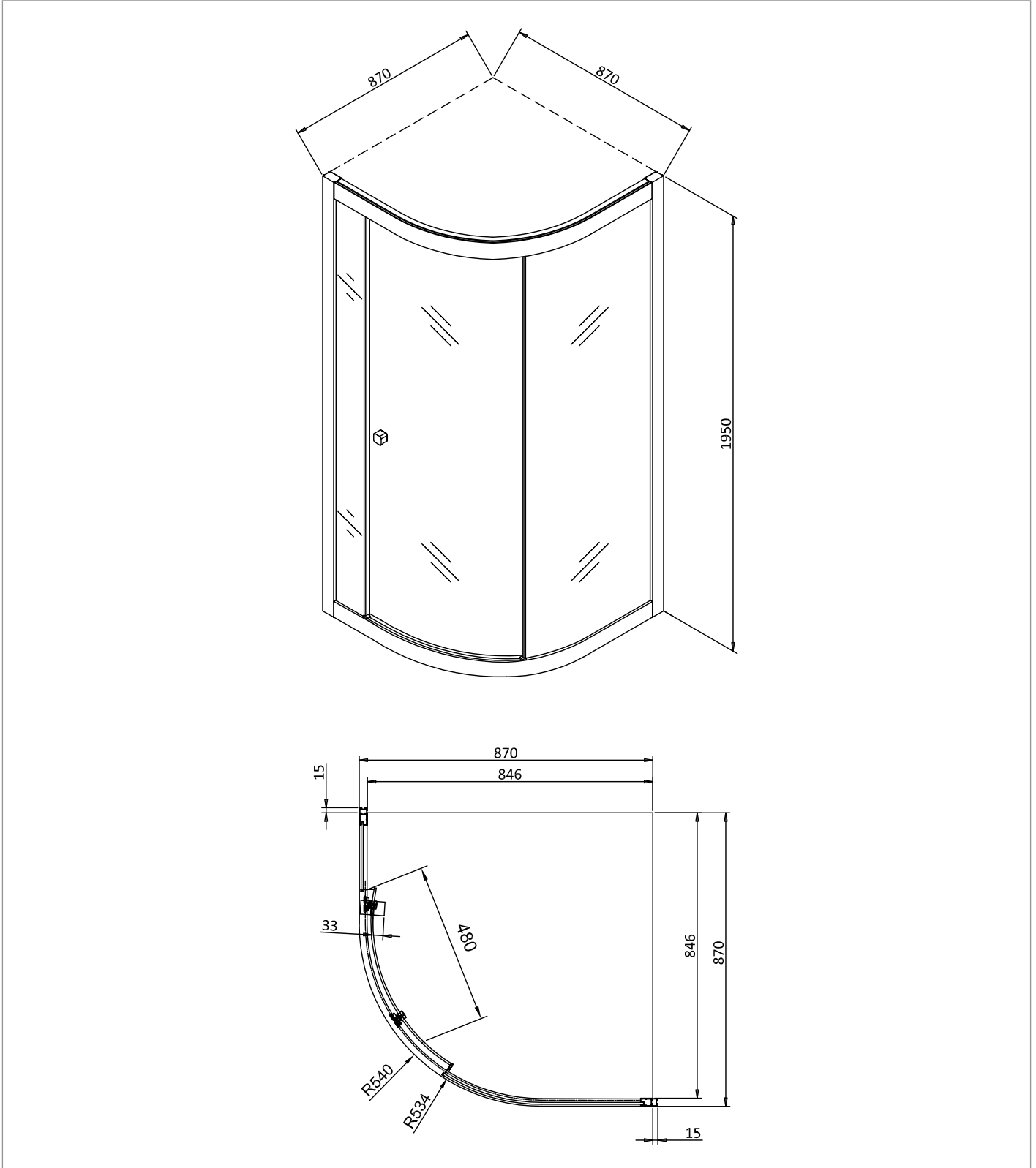

SPARES LIST

Only the parts labelled are available as spares.

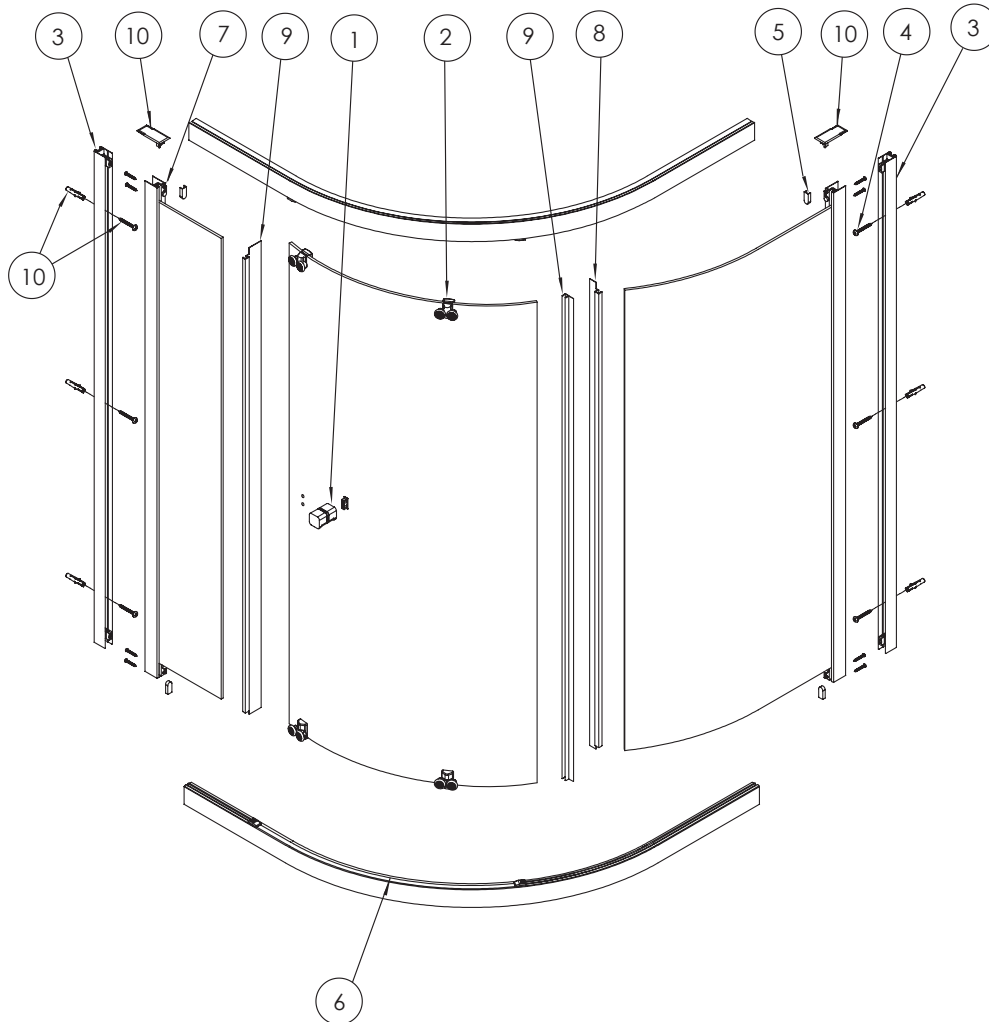

NUMBER	PART CODE	DESCRIPTION
1	CA600006F	Clear Handle All Models x1 Br Brass
2	CA600032F	Clear Quad Rollers Top Bottom Br Brass
3	CAPROFILEF	Clear Wall Profile Br Brass
4	CA000036F	Clear 6 Screw Cover All Doors Br Brass x3
5	CA600004F	Clear Lock Cover x4 Br Brass
6	CA600040F	Clear 6 Track Cover Slider/Quad Br Brass
7	ET0000031	Clear 6 Locking Levers
8	CA600009	Clear Seal Single Door Quad Part F
9	CA600008	Clear Seal Single Door Quad Part E
10	CAQUADKITF	Clear 6 Install Pack Quad Br Brass