

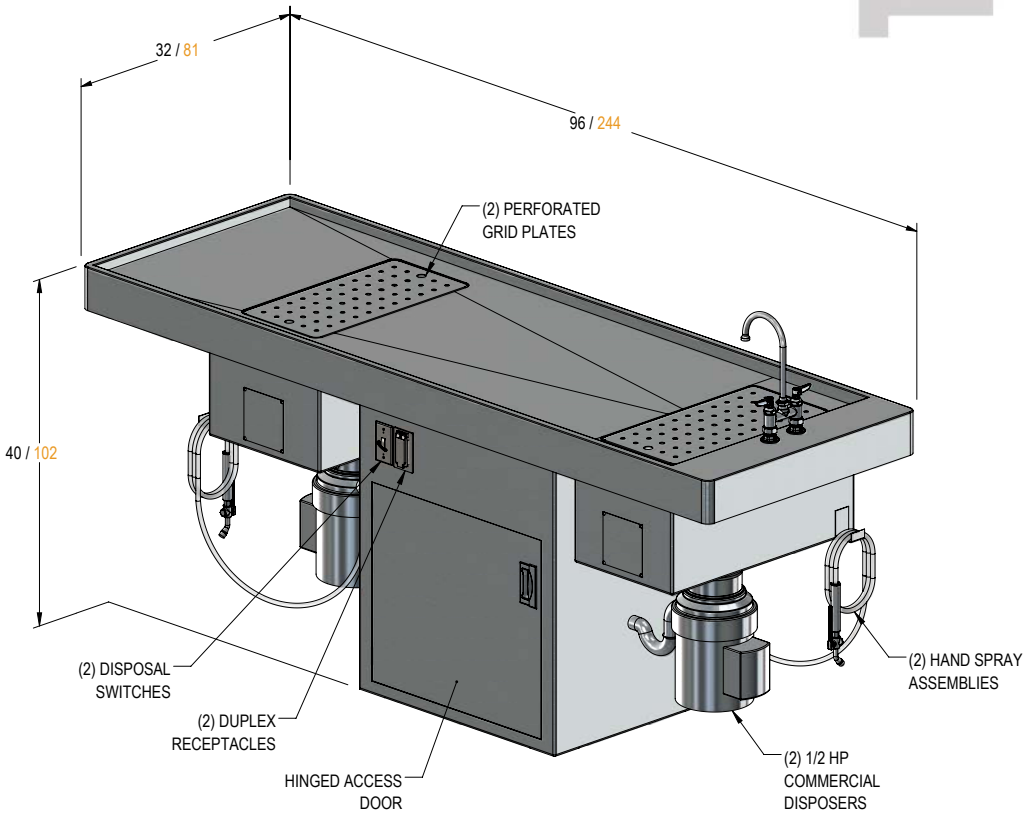

Optional Features & Accessories

See pages 9-17 to 9-19 for a full list of sink station accessories.



STANDARD DESIGN FEATURES

- Width:32 in./81 cm.
- Length:96 in./243 cm.
- Height:40 in./101 cm.

(2) Large single Compartment Sink Basin:

- Length:24 in./60 cm.
- Width:12 in./30 cm.
- Depth:8 in./20 cm.

- Type 304 stainless steel construction
- Helic-welded seams and joints, ground and polished to match adjoining surfaces
- Radii on all inside and outside corners for easy cleaning
- Downdraft ventilation provided at each sink location
- (2) Spray hose assemblies with cold water control valves, nozzles, 10 ft./3 m. of flexible hose and back flow prevention
- Removable perforated sink covers
- Mixing faucet with gooseneck spout and wrist blade handles
- (2) Heavy-duty 1/2 hp commercial disposers with switches
- Rapid and positive drainage
- Removable access panel
- (2) GFCI duplex receptacle w/waterproof cover
- Plumbing and electrical lines are factory-installed and require only single-point connection at the project location



NECROPSY DISSECTION TABLES

Options based on available space

When planning an order, we will assist you in selecting options to complete your system. Feel free to contact your sales associate.

Pictured accessories may differ depending on your unit and other optional accessories. Not all accessories available for all models. Please review the model's standard features to ensure accuracy of specifications.



LC-50 - 1/2 HP HEAVY DUTY COMMERCIAL DISPOSER

Standard on most sinks. Variable power options. Available in 1/2, 1 or 2 HP.



SS-100, SS-200 - HEAVY DUTY COMMERCIAL DISPOSER

Variable power options. Available in 1 or 2 HP.



OA-100-DM - CO2/NATURAL GAS VALVES

All brass with chrome plated finish. Deck Mounted. Visually marked for type of function required.



OA-101-DM - COMPRESSED AIR VALVE

All brass with chrome plated finish. Deck Mounted. Visually marked for type of function required.



OA-102-DM - VACUUM VALVES

All brass with chrome plated finish. Deck Mounted. Visually marked for type of function required.



OA-100-WM - CO2/NATURAL GAS VALVES

All brass with chrome plated finish. Wall Mounted. Visually marked for type of function required.



OA-101-WM - COMPRESSED AIR VALVE

All brass with chrome plated finish. Wall Mounted. Visually marked for type of function required.



OA-102-WM - VACUUM VALVES

All brass with chrome plated finish. Wall Mounted. Visually marked for type of function required.



OA-111 - EMERGENCY EYEWASH / HOSE ASSEMBLY

Hand controlled spray to provide a gentle flow of water to rinse eyes of foreign debris.



OA-112 - EYEWASH / FAUCET ASSEMBLY

Deck mounted eye wash for hands free eye wash or can be removed for use as a drench hose for eye, face, or body use coverage.



OA-113 - EYEWASH - FLIP DOWN STYLE

Wall mounted polished chrome-plated brass single action pull down activated eye/face wash.

CUSTOM LAYOUT AND DESIGN

We understand that every project is unique. If you have special requirements, we can modify the stations to suit your needs. A custom layout can consist of modifications to allow larger or restricted work areas, additional utilities, shelving, drawers and ventilation.

NECROPSY DISSECTION TABLES

Pictured accessories may differ depending on your unit and other optional accessories. Not all accessories available for all models. Please review the model's standard features to ensure accuracy of specifications.



OA-500 - TABLE END RINSE ASSEMBLY
Washes debris towards sink basin controlled by cold water valve or hands free control with back flow prevention.



OA-501 - THREE SIDED RINSE ASSEMBLY
Provides a rinse to gently wash debris and non-viable material away from the work area. A sturdy stainless steel assembly controlled by an ON/OFF valve.



OA-507 - HOT AND COLD FOOT VALVE
Sturdily constructed hot/cold foot pedal helps temper water and keep your hands free while working.



OA-215 - SPRAY RINSE WITH CONTROL VALVE AND VACUUM BREAKER Wall mounted spray rinse hose assembly.

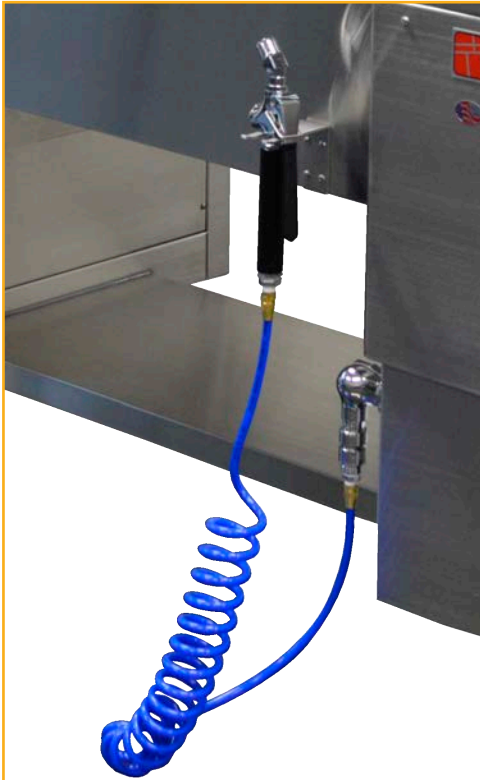

OA-506 - SPRAY HOSE ASSEMBLY WITH BACKFLOW & RECOIL HOSE Wash off contaminants and debris with flexible and wide reaching recoil hose.



OA-204 - HANDS FREE MIXING FAUCET
Toggle a steady stream of water with this motion activated sensor.



OA-203 - ADDITIONAL MIXING FAUCET WITH VACUUM BREAKER Add an additional faucet with vacuum breaker included.



OA-511 - 3 WAY DIVERTER DRAIN
Change direction of drainage flow using a directional control knob.



OA-505 - FULL PERFORATED GRID PLATES
Specify Model.



DD - DOWNDRAFT VENTILATION ASSEMBLY - CONE

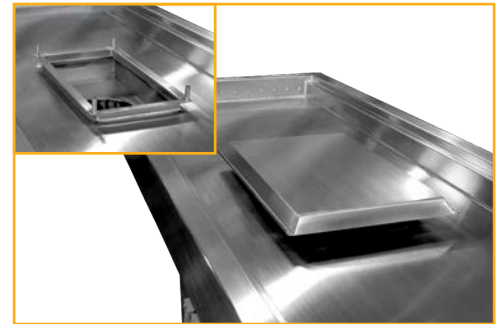

TD - TOTAL DOWNDRAFT VENTILATION ASSEMBLY

Pictured accessories may differ depending on your unit and other optional accessories. Not all accessories available for all models. Please review the model's standard features to ensure accuracy of specifications.

NECROPSY DISSECTION TABLES



OA-525 - SINK COVER - PERFORATED

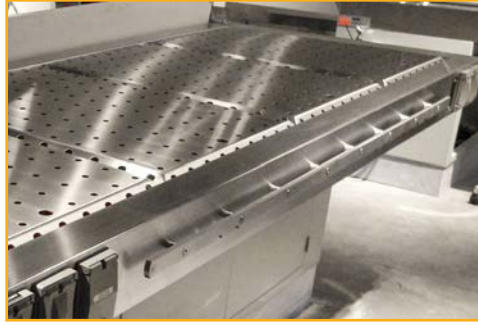

OA-502 - TIE DOWN BARS

Provides a conveniently placed bar to secure animals during surgery and necropsy procedures. 3 ft. section/2 ties multiply per table length and sides required.



OA-503 - NYLON TIE STRAP

Conveniently secure animals during surgery and necropsy procedures.



OA-510 - HYDRO-ASPIRATOR ASSEMBLY, DECK MOUNT With built-in vacuum breaker and control lever used to reverse the flow of water directing it through the hose connections for drawing fluid or rinsing.



LW481 - ASPIRATOR EXTENSION

Fabricated from chrome plated brass and provides further safety against polluted backflow.



LW482 - NON-CLOGGING ASPIRATOR HEAD

Prevents large debris from entering and clogging the system.



AHT - TROCAR TUBING

10 ft. min., priced per foot. Clear vinyl Aspirator/Trocar tubing. Internal diameter of .375 in. and outside diameter of .625 in.



AHS - ASPIRATOR DISCHARGE TUBING

3 ft. min., priced per foot. Splash tubing for aspirator drain, embalming and autopsy tops. Internal diameter of 1 in. and outside diameter of 1.25 in.



OA-152 - HANDS FREE SOAP DISPENSERS

High-efficiency pump mechanism provides quick and precise dispensing. Easy-to-use button control and the wide opening makes refills fast, easy and mess-free. (2) models available: Deck and Wall Mount.



OA-526 - STAINLESS STEEL WORK AREA DIVIDERS



OA-154 - SHARPS DISPOSAL CONTAINER

Solution for disposal of needles, syringes, and lancets, as well as other types of sharps and small quantities of medical waste.



OA-126 - VENTILATED TRASH CONTAINER

Stainless steel construction, removable top lid, holds 13 gallon trash liner, 1.5 in. duct attaches to station exhaust system for fume removal, Container size: 13 in. x 13 in. x 29 in.

NECROPSY DISSECTION TABLES



OA-136 - MONITOR AND KEYBOARD MOUNT Allows full articulation of the flat panel monitor and keyboard, folds up over the mount and extends up to 11 in. Available as wall mount or 19 in. or 36 in. track.



OA-166 - SINGLE TABLET MOUNT Spring loaded cradle expands and contracts to fit most tablets. Securely holds with exceptional range of motion.



OA-167 - LAPTOP MOUNT Allows full articulation of laptop platform, folds up over the mount and extends up to 11 in. Available as wall mount or 19 in. or 36 in. track.



OA-145 - CPU WALL MOUNT Designed to fit CPU's from 4, 6, and 8 in. wide. Units are constructed from heavy duty aluminum, with neoprene padding to protect your CPU as it is clamped securely into the mount.

Build Your Own Mount

Mortech can offer numerous configuration options, solutions and combinations:

- Over 2,000 modular arm designs that can be adapted to your needs.
- Custom bracket and attachment options to fit your specific device.
- Fully custom mounts to meet your unique challenge

ARM SEGMENTS



When configuring your custom setup, please consider these questions:

- *Mounting to what surface?*
- *Mounting a flat panel monitor?*
- *Mounting a keyboard?*
- *Mount type?*
- *What arm segments?*
- *Arm segment length?*
- *Separate arms?*
- *Keyboard tray size?*
- *Keyboard tray type?*

Pictured accessories may differ depending on your unit and other optional accessories. Not all accessories available for all models. Please review the model's standard features to ensure accuracy of specifications.



TRACK MOUNT



WALL MOUNT

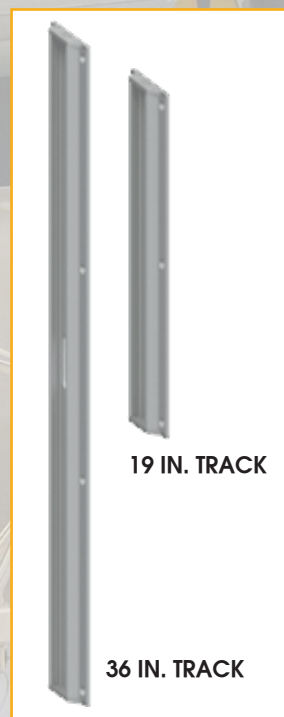

19 IN. TRACK

36 IN. TRACK

Pictured accessories may differ depending on your unit and other optional accessories. Not all accessories available for all models. Please review the model's standard features to ensure accuracy of specifications.

NECROPSY DISSECTION TABLES



OA-124 - LED MAGNIFIER LIGHT
Flexible spring-balanced articulating arm, handle in shade permits easy positioning.

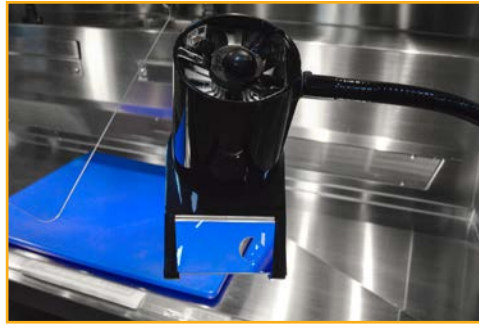

OA-123 - FLEX ARM MAGNIFIER LIGHT
Flexible spring-balanced arm, handle in shade permits easy positioning. Retractable magnifying extension for closer examination.



OA-156 - FLEX ARM LED LIGHT
Adjustable to all angles using a 30 in. flexible arm and powerful LED bulb.



SLSE50-DK - SURGICAL EXAM LIGHT
Delivers best in class intensity and color. Dual lens optical system collects and concentrates light into a precise beam.



M184042 - SLMAG - MAGNIFYING EXAM LIGHT World class optics, performance and precision movement. The perfect combination of light quality, positionability and large viewing area.



WAVE - LED MAGNIFIER LIGHT
Large viewing area and LED energy saving technology with a 3.5 diopter magnifier.



LW418 - ELECTRONIC SCALE - PLATFORM
6.5 in. x 5.5 in. Platform, 2000g.
Compact, lightweight, portable and perfectly suited for laboratory and educational purposes. 2200 x 1 gm.



LW419 - ELECTRONIC SCALE - PLATFORM
6.6 in. x 6 in. Platform, 2100g.
Compact, lightweight, portable and perfectly suited for laboratory and educational purposes. 2200 x .1 gm.

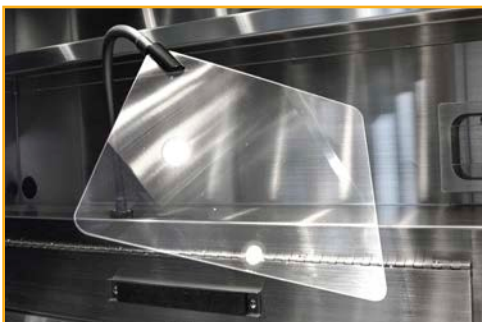

OA-141 - SAFETY SPLASH GUARD
Mounted per customer specification. Articulating arm allows protection for both specimen and user from cross contamination.

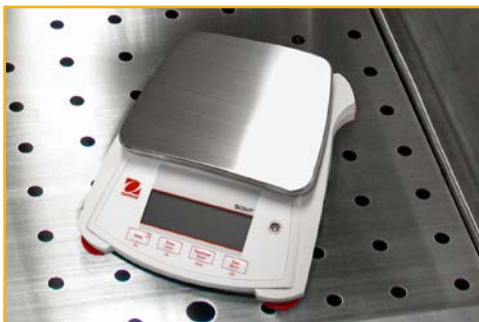

LW425 - ELECTRONIC SCALE - PLATFORM
6 in. Platform, 2000g.
Compact, lightweight, portable and perfectly suited for laboratory and educational purposes. 2200 x .1 gm.



LW411 - SCALE POLE AND MOUNTING BRACKET For use with standard hanging autopsy scale. Pole can swivel left and right, and includes locking knob.

NECROPSY DISSECTION TABLES



OA-158 - STAINLESS C-FOLD PAPER TOWEL HOLDER Surface mounted towel dispenser. Fabricated of type 304, 22 gauge stainless.



OA-159 - STAINLESS C-FOLD PAPER TOWEL HOLDER - OPEN DESIGN Surface mounted towel dispenser with open design.



OA-148-1 - ADJUSTABLE STAINLESS STEEL SHELF - ONE All stainless steel construction adds storage space for accessories. Adjustable shelf is 12 in. L x 7.5 in D.



OA-148-2 - ADJUSTABLE STAINLESS STEEL SHELF - TWO All stainless steel construction adds storage space for accessories. Adjustable shelf is 12 in. L x 7.5 in D.



OA-149 - STATONARY STAINLESS STEEL SHELF - ONE All stainless steel construction adds storage space for accessories. Stationary shelf is 12 in. L x 7.5 in D.



OA-252 - FOLDING EXTENSION SHELF Stainless steel construction adds storage space for accessories. Up to 36 in. W x 24 L. in.



OA-127 - UTILITY DRAWER Constructed of all stainless steel, this drawer is ideal for additional storage of utensils, office supplies or personal items



OA-128 - WRITING PLATFORM Sturdy stainless steel construction provides a reliable smooth surface for writing and conveniently hides away.



OA-129 - COMBO UTILITY DRAWER / WRITING PLATFORM Conveniently combines both accessories in one, a writing platform with storage drawer underneath.



OA-133 - FORM HOLDER Sturdy construction and can be mounted to store documents away from any fluids and risk of damage, (2) provided standard.



OA-125-24, OA-504-48, OA-302-78 - REMOVABLE MEASURING RULER Available in 24 in., 48 in. and 78 in. Provides a convenient measuring device, easily accessed and mounted in plain sight.

Options based on available space

When planning an order, we will assist you in selecting options to complete your system. Feel free to contact your sales associate.

Pictured accessories may differ depending on your unit and other optional accessories. Not all accessories available for all models. Please review the model's standard features to ensure accuracy of specifications.

Pictured accessories may differ depending on your unit and other optional accessories. Not all accessories available for all models. Please review the model's standard features to ensure accuracy of specifications.

NECROPSY DISSECTION TABLES



LW385, LW386, LW387 - DISSECTING BOARDS Available in 24 in. x 18 in., 18 in. x 12 in. & 20 in. x 15 in.



LW389 - PHOTO-BLUE DISSECTING BOARD Manufactured from high-density polyethylene, providing an excellent cutting surface. Bottom corners have a non-skid rubber foot attached.



LW379 - DISSECTING BOARDS w/ 3 in. LEGS Manufactured from high density polyethylene. Provides an excellent cutting surface. 20 in length x 15 in width x .75 in thick cutting board



LW379A - RAISED DISSECTING PLATFORM Manufactured from high density polyethylene with adjustable legs. Provides an excellent cutting surface. Color is photo blue.



LW380 - INSTRUMENT DISSECTING TRAY Stainless steel construction. Heavy gauge material provides a highly stable work surface. Tray creased toward center drain with optional hose attachment to route flow. Custom heights available.



LW390 - HEADREST
LW390-A - HEADREST - Aluminum
LW390-B - HEADREST - Black



LW485 - EVIDENCE SCREEN Designed to prevent evidence from being washed down drain. Fabricated from perforated stainless steel. For use in 3.5 in. diameter drains.



LW487 - ORGAN RINSE BASKET Designed to hang on the interior of the sink basin. Ideal for rinsing organs. Fabricated from stainless steel with a perforated bottom.



OA-144 - MAGNETIC INSTRUMENT HOLDER Conveniently store and organize your instruments.



OA-520, OA-521 - DRAWER ASSEMBLY Add a utility drawer. Available in single and double.



OA-523 - MAGNAHELIC GAUGE Quickly indicates air or noncorrosive gas pressures—either positive, negative (vacuum) or differential.



OA-147-1, OA-147-2, OA-147-3 - GLOVE BOX HOLDER Stainless Steel support to hold latex and nitrile glove boxes, holders come in a side or top load model. Available in 1, 2, & 3 capacity.

Also Available:

**OA-524 -
FLUID HOLDING TANK,
50 GAL., WITH CASTERS**

**OA-530 -
HEIGHT ADJUSTMENT,
6 IN., ELECTRIC**

**OA-535 -
HEIGHT ADJUSTMENT,
6 IN., HAND CRANK**



OA-512 - FORMALIN CARBOY W/ SPIGOT
Space saving rectangular shape and chemical resistant holds 9 liters.



OA-515 - FORMALIN DISPENSING AND COLLECTION 2.5 gal. container and receptacle hold reserve formalin and collects waste. Foot controlled motor dispenses formalin at a steady flow. Conveniently placed formalin supply spout included.

Multiple Formalin Options Available:

- OA-119 - FORMALIN DISPENSING ONLY - FROM BUILDING**
- OA-120 - FORMALIN DISPENSING ONLY - SELF CONTAINED**
- OA-121 - FORMALIN COLLECTION ONLY - TO BUILDING**
- OA-122 - FORMALIN COLLECTION ONLY - SELF CONTAINED**
- OA-162 - FORMALIN DISPENSING & COLLECTION - CUBE STYLE**
- OA-163 - FORMALIN DISPENSING ONLY SYSTEM - CUBE STYLE**

Pictured accessories may differ depending on your unit and other optional accessories. Not all accessories available for all models. Please review the model's standard features to ensure accuracy of specifications.

