

PATHOLOGY GROSSING STATIONS



The pathology workstation is an economical space saving unit that comes with all required features for any grossing procedure. We also carry a complete listing of optional accessories to fulfill anyone's personal needs.

STANDARD DESIGN FEATURES

Length:48 in./121 cm.
Length:60 in./152 cm.
Height/Overall:51 in./129 cm.
Width:30 in./76 cm.

- Available in two sizes: 48 in./121 cm. long and 60 in./152 cm. long
- All stainless steel construction of the entire work area and all exterior closure panels
- Exhaust duct for connection to building ventilation system
- Hot and cold water mixing faucet with gooseneck spout and wrist blade handles

- Spray hose assembly with hand control
- Heavy-duty commercial waste disposer, 1/2 hp and switch
- Dissecting area rinse to provide a constant flow of water to work area
- Specimen shelf, welded heavy gauge stainless steel
- Removable stainless steel dissecting grid plates located over the drain trough
- Fluorescent, vapor-proof light with switch
- Polyethylene dissecting board (Photo Blue)
- GFCI duplex receptacle w/waterproof cover
- Dissecting area is sloped toward sink basin for rapid and positive drainage
- Heavy-gauge polished stainless steel leg assembly with welded cross rails to handle heavy-duty usage
- Wheel chair accessible

All measurements in inches/centimeters

We also carry Biopsy Bags



Call for more information
(800) 410-0100

MODEL GL117 PATHOLOGY WORKSTATION w/REAR EXHAUST

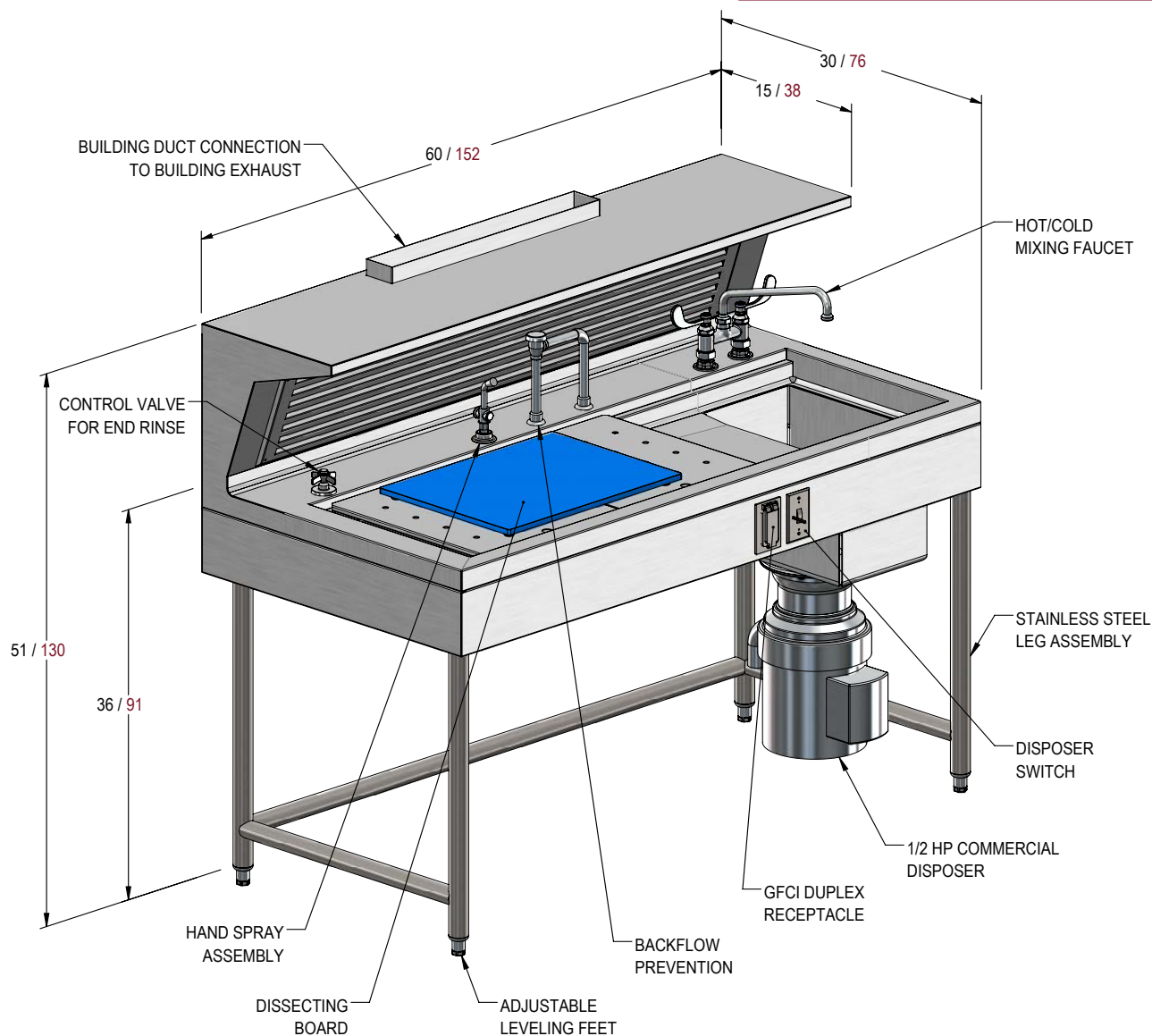

Optional Accessories

See a full list of Grossing Station Accessories at the end of this section.

Options based on available space

When planning an order, we will assist you in selecting options to complete your system. Please feel free to contact us.

Custom layout and designs are available.

**MODEL GL117
LAYOUT DRAWING & OPTIONAL FEATURES**

PATHOLOGY GROSSING STATIONS

OPTIONS & ACCESSORIES

Options based on available space

When planning an order, we will assist you in selecting options to complete your system. Feel free to contact your sales associate.



OA-103 - HANDS FREE CONTROLS - HOT/COLD WATER Individual control for easy on/off activation of hot/cold water. Hot and Cold water sensors always sold together.



SENSOR - HANDS FREE CONTROLS



Pictured accessories may differ depending on your unit and other optional accessories. Not all accessories available for all models. Please review the model's standard features to ensure accuracy of specifications.



OA-105 - HANDS FREE CONTROLS - DISPOSAL Individual control for easy on/off activation of disposer.



OA-106 - HANDS FREE CONTROLS - END RINSE Individual control for easy on/off activation of end rinse.



OA-107 - HANDS FREE CONTROLS Individual control for easy on/off activation of table rinse, mixing faucet, waste disposal, and hot/cold water.



OA-142 - ARTICULATING VIDEO CAMERA MOUNT Articulated arm with large locking knob with variable friction on an adjustable slide track. Supplied with a quick release camera plate and secondary safety lock.



OA-110 - ARTICULATING CAMERA MOUNT Articulated arm with large locking knob with variable friction on an adjustable slide track. Supplied with a quick release camera plate and secondary safety lock.



OA-109 - MICROPHONE ON FLEX ARM Easy-to-adjust, small-diameter, alternating gooseneck provides a steep low frequency attenuation to improve sound pickup without affecting voice quality.



OA-134 - VOICE ACTIVATED RECORDER Easy to use voice recorder. Equipped with a front facing LCD screen, both convenient and compact.



OA-134-FP - FOOT PEDAL - VOICE ACTIVATED RECORDER Foot pedal allows for hands-free control of the recording and playback process.



OA-135 - KEYBOARD MOUNT ONLY
Allows full articulation of the keyboard, extends up to 11 in. Available as wall mount or 19 in. track.



OA-136 - MONITOR AND KEYBOARD MOUNT Allows full articulation of the flat panel monitor and keyboard, folds up over the mount and extends up to 11 in. Available as wall mount or 19 in. track.



OA-137 - MONITOR AND KEYBOARD MOUNT - SEPARATE Allows full individual articulation of the flat panel monitor and keyboard, folds up over the mount and extends up to 11 in. Available as wall mount or 19 in. track.



OA-138 - DUAL MONITOR AND KEYBOARD MOUNT Holds (2) monitors horizontally or vertically on a fully articulating arm with mouse and keyboard supports. Folds up over the mount and extends Up to 11 in. Available as wall mount or 19 in. track.



OA-164 - SINGLE MONITOR MOUNT Allows full articulation of the flat panel monitor, folds up right over the mount and extends up to 11 in. Available as wall mount or 19 in. track.



OA-165 - DUAL MONITOR MOUNT Holds (2) monitors horizontally or vertically on a fully articulating arm. Folds up over the mount and extends Up to 11 in. Available as wall mount or 19 in. track.



OA-166 - SINGLE TABLET MOUNT
Spring loaded cradle expands and contracts to fit most tablets. Securely holds with exceptional range of motion.



OA-167 - LAPTOP MOUNT
Allows full articulation of Laptop platform, folds up over the mount and extends up to 11 in. Available as wall mount or 19 in. track.

Build Your Own Mount

Mortech can offer numerous configuration options, solutions and combinations:

- Over 2,000 modular arm designs that can be adapted to your needs.
- Custom bracket and attachment options to fit your specific device.
- Fully custom mounts to meet your unique challenge.

When configuring your custom setup, please consider these questions:

- *Mounting to what surface?*
- *Mounting a flat panel monitor?*
- *Mounting a keyboard?*
- *Mount type?*
- *What arm segments?*
- *Arm segment length?*
- *Separate arms?*
- *Keyboard tray size?*
- *Keyboard tray type?*



OA-139 - STATIONARY MONITOR MOUNT ON BACKSPASH Flat panel monitor attaches directly to backplash of grossing station.



OA-145 - CPU WALL MOUNT
Designed to fit CPU's from 4.6 to 8 in. wide. Units are constructed from heavy-duty aluminum, with neoprene padding to protect your CPU as it is clamped securely into the mount.

Pictured accessories may differ depending on your unit and other optional accessories. Not all accessories available for all models. Please review the model's standard features to ensure accuracy of specifications.

PATHOLOGY GROSSING STATIONS



OA-124 - LED MAGNIFIER LIGHT
Flexible spring-balanced articulating arm, handle in shade permits easy positioning.

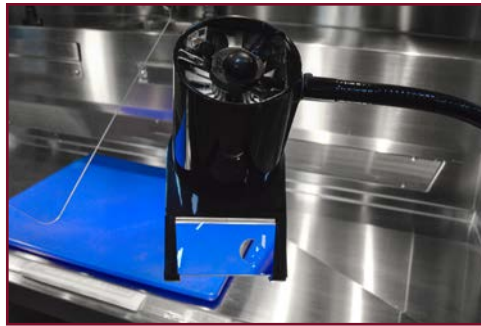

OA-123 - FLEX ARM MAGNIFIER LIGHT
Flexible spring-balanced arm, handle in shade permits easy positioning. Retractable magnifying extension for closer examination.



OA-156 - FLEX ARM LED LIGHT
Adjustable to all angles using a 30 in. flexible arm and powerful LED bulb.



SLSE50-DK - SURGICAL EXAM LIGHT
Delivers best in class intensity and color. Dual lens optical system collects and concentrates light into a precise beam.

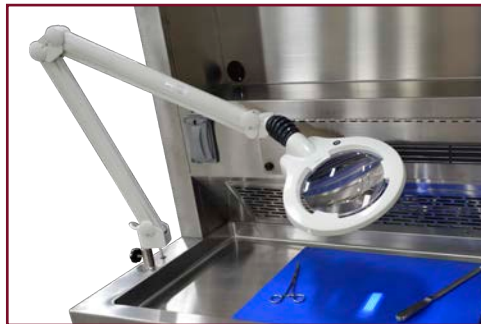

M184042 - SLMAG - MAGNIFYING EXAM LIGHT
World class optics, performance and precision movement. The perfect combination of light quality, positionability and large viewing area.



WAVE - LED MAGNIFIER LIGHT
Large viewing area and LED energy saving technology with a 3.5 diopter magnifier.



OA-130-110 - SINGLE X-RAY ILLUMINATOR
Available in 110 or 230v. "Instant on" lighting, maximum quality and flexibility for radiological film interpretation. Ideal for use in hospital and medical high-volume environments.

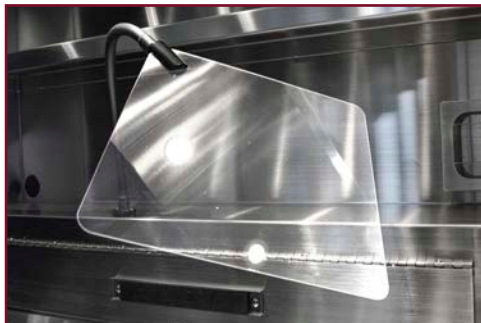

OA-141 - SAFETY SPLASH GUARD
Mounted per customer specification. Articulating arm allows protection for both specimen and user from cross contamination.



OA-146 - FULL PLEXIGLASS ENCLOSURE
Covers and protects the working area for a clean and sanitary area. Constructed of 0.5 in./1 cm. plexiglass, contains fumes and reduces contaminants.



OA-155 - DRY ERASE BOARD
Provides easy dry-erase writing for meetings, brainstorming and discussions. Strong fiberboard and frame resist warping and bending.



OA-144 - MAGNETIC INSTRUMENT HOLDER
Conveniently store and organize your instruments.



OA-125-24, OA-504-48 - REMOVABLE MEASURING RULER
Available in 24 in. and 48 in.. Provides a convenient measuring device, easily accessed and mounted in plain sight. Also available in 48 in. Provides a convenient measuring device, easily accessed and mounted in plain sight.

Pictured accessories may differ depending on your unit and other optional accessories. Not all accessories available for all models. Please review the model's standard features to ensure accuracy of specifications.

PATHOLOGY GROSSING STATIONS

Pictured accessories may differ depending on your unit and other optional accessories. Not all accessories available for all models. Please review the model's standard features to ensure accuracy of specifications.



OA-147-1, OA-147-2, OA-147-3 GLOVE BOX HOLDER Stainless steel support to hold latex and nitrile glove boxes. Holders come in a side or top load model. Available in 1, 2, & 3 capacity.

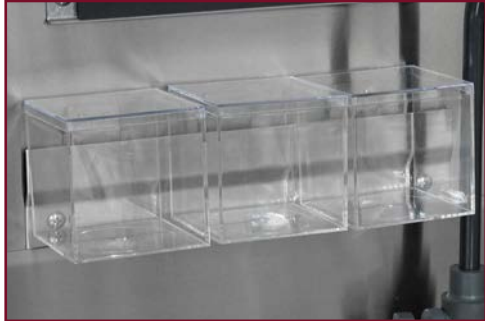

OA-125 - CASSETTE HOLDERS - SET OF 3 Conveniently holds cassettes within arms reach and removable boxes mount to rail on front of unit. Set of (3) boxes provided

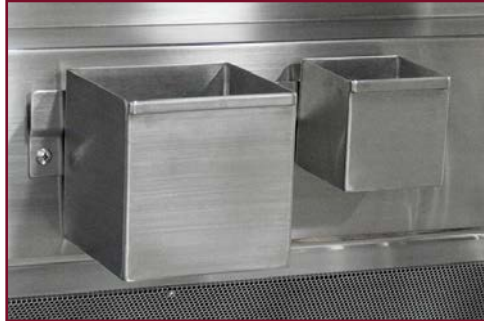

OA-132 - STAINLESS STEEL STORAGE CONTAINERS Set in a No. 4 finish. Removable containers come (1) large and (1) small each, per order.



OA-158 - STAINLESS C-FOLD PAPER TOWEL HOLDER Surface mounted towel dispenser. Fabricated of type 304, 22 gauge stainless.



OA-159 - STAINLESS C-FOLD PAPER TOWEL HOLDER - OPEN DESIGN Surface mounted towel dispenser with open design.



OA-148-1 - ADJUSTABLE STAINLESS STEEL SHELF - ONE All stainless steel construction adds storage space for accessories. Adjustable shelf is 12 in. W x 7.5 in. L.



OA-148-2 - ADJUSTABLE STAINLESS STEEL SHELF - TWO All stainless steel construction adds storage space for accessories. Adjustable shelf is 12 in. W x 7.5 in. L.



OA-149 - STATIONARY STAINLESS STEEL SHELF - ONE All stainless steel construction adds storage space for accessories. Stationary shelf is 12 in. W x 7.5 in. L.



OA-133 - FORM HOLDER Sturdy construction and can be mounted to store documents away from any fluids and risk of damage, (2) provided standard.



OA-127 - UTILITY DRAWER Constructed of all stainless steel, this drawer is ideal for additional storage of utensils, office supplies or personal items



OA-128 - WRITING PLATFORM Sturdy stainless steel construction provides a reliable smooth surface for writing and conveniently hides away.



OA-129 - COMBO UTILITY DRAWER / WRITING PLATFORM Conveniently combines both accessories in one, a writing platform with storage drawer underneath.

Pictured accessories may differ depending on your unit and other optional accessories. Not all accessories available for all models. Please review the model's standard features to ensure accuracy of specifications.

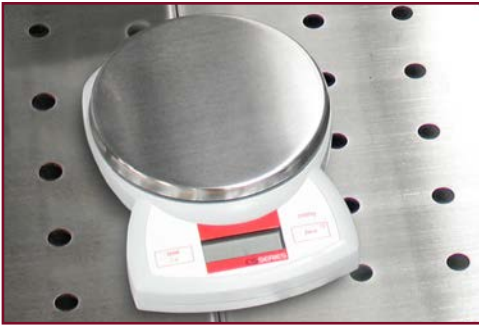

LW418 - ELECTRONIC SCALE - PLATFORM 6.5 x 5.5 in. Platform, 2000 gm.
Compact, lightweight, portable and perfectly suited for laboratory and educational purposes. 2200 x 1 gm.



LW419 - ELECTRONIC SCALE - PLATFORM 6.6 x 6 in. Platform, 2100 gm.
Compact, lightweight, portable and perfectly suited for laboratory and educational purposes. 2200 x .1 gm.



LW425 - ELECTRONIC SCALE - PLATFORM 6 in. Platform, 2000 gm.
Compact, lightweight, portable and perfectly suited for laboratory and educational purposes. 2200 x .1 gm.



OA-154 - SHARPS DISPOSAL CONTAINER
Solution for disposal of needles, syringes, and lancets, as well as other types of sharps and small quantities of medical waste.



OA-153 - SPECIMEN RINSE BASKET/HOLDER FOR SINK Single mesh fine with a plastic handle includes stainless holder that fits over sink.



OA-152 - HANDS FREE SOAP DISPENSERS
High-efficiency pump mechanism provides quick and precise dispensing. Easy-to-use button control and the wide opening makes refills fast, easy and mess-free. (2) models available: Deck and Wall Mount.



OA-126 - VENTILATED TRASH CONTAINER
Stainless steel construction, removable top lid, holds 13 gallon trash liner, 1.5 in. duct attaches to station exhaust system for fume removal, Container size: 13 in. x 13 in. x 29 in.



OA-140 - FLOOR MOUNT ANCHORS
Securely holds your grossing station in place with sturdy gauge floor mount brackets. Engineered seismic calculations available at an additional cost.



OA-161 - STAINLESS STEEL TISSUE MARKING DYE TRAY Conveniently stores tissue dye bottles within reach and easily accessible.



OA-108 - SELF CONTAINED VENTILATION ASSEMBLY Consisting of 3 blowers with filters to clean and safely recycle air within your work area.



OA-143 - REPLACEMENT EXHAUST BELLOWS
Adjustable bellows replacement for exhaust duct connection to building ventilation system.



GL113 - REPLACEMENT FILTERS - MODEL GL113 Activated filter for odorous and formaldehyde fumes.

PATHOLOGY GROSSING STATIONS

Pictured accessories may differ depending on your unit and other optional accessories. Not all accessories available for all models. Please review the model's standard features to ensure accuracy of specifications.



OA-100-DM - CO2/NATURAL GAS VALVES
All brass with chrome plated finish. Deck mounted. Visually marked for type of function required.



OA-101-DM - COMPRESSED AIR VALVE
All brass with chrome plated finish. Deck mounted. Visually marked for type of function required.



OA-102-DM - VACUUM VALVES
All brass with chrome plated finish. Deck mounted. Visually marked for type of function required.



OA-100-WM - CO2/NATURAL GAS VALVES
All brass with chrome plated finish. Wall mounted. Visually marked for type of function required.



OA-101-WM - COMPRESSED AIR VALVE
All brass with chrome plated finish. Wall mounted. Visually marked for type of function required.



OA-102-WM - VACUUM VALVES
All brass with chrome plated finish. Wall mounted. Visually marked for type of function required.



OA-111 - EMERGENCY EYEWASH / HOSE ASSEMBLY
Hand controlled spray to provide a gentle flow of water to rinse eyes of foreign debris.



OA-112 - EYEWASH / FAUCET ASSEMBLY
Deck mounted eyewash for hands free eye wash or can be removed for use as a drench hose for eye, face, or body use coverage.



OA-113 - EYEWASH - FLIP DOWN STYLE
Wall mounted polished chrome-plated brass single action pull down activated eye/face wash.



OA-150 - SPRAY HOSE ASSEMBLY
Easy grip assembly with flexible hose, conveniently placed for easy spray cleaning.

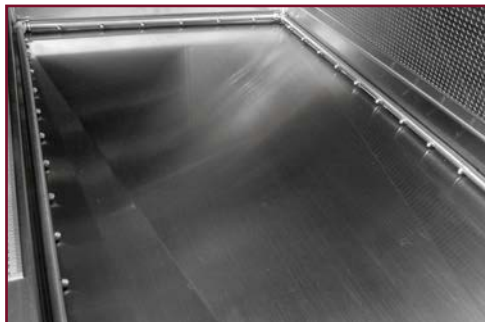

OA-115 - THREE SIDED RINSE ASSEMBLY
Washes debris towards sink basin controlled by cold water valve or hands free control.



OA-116 - END RINSE ASSEMBLY
Washes debris towards sink basin controlled by cold water valve or hands free control with back flow prevention.

PATHOLOGY GROSSING STATIONS



LC-50 - 1/2 HP HEAVY DUTY COMMERCIAL DISPOSER
Standard on most sinks. Variable power options. Available in 1/2, 1 or 2 HP.



SS-100, SS-200 - HEAVY DUTY COMMERCIAL DISPOSER
Variable power options. Available in 1 or 2 HP.

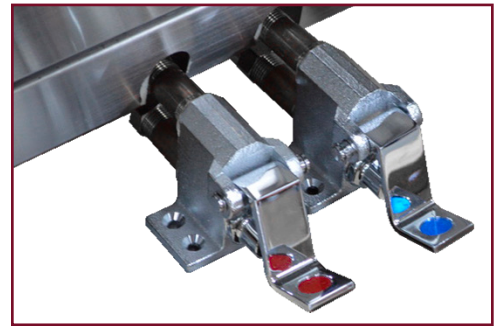

OA-151 - HOT AND COLD FOOT VALVE
Sturdily constructed hot/cold foot pedal helps temper water and keep your hands free while working.



OA-117 - FLAMMABLE STORAGE CABINET
NOT FOR ALL UNITS - Protect workers, reduce fire risks, and improve productivity by storing hazardous liquids

Options based on available space

When planning an order, we will assist you in selecting options to complete your system. Feel free to contact your sales associate.



OA-118 - FORMALIN DISPENSING AND COLLECTION 2.5 gal. container and receptacle hold reserve formalin and collects waste. Foot controlled motor dispenses formalin at a steady flow.



OA-162 - FORMALIN DISPENSING & COLLECTION - CUBE STYLE
Container and receptacle hold reserve formalin and collects waste. Foot controlled motor dispenses formalin at a steady flow. Conveniently placed formalin supply spout included.

Pictured accessories may differ depending on your unit and other optional accessories. Not all accessories available for all models. Please review the model's standard features to ensure accuracy of specifications.



OA-157 - FORMALIN CARBOY W/ SPIGOT
Space saving rectangular shape and chemical resistant holds 9 liters.

Multiple Formalin Options Available:

- OA-119 - FORMALIN DISPENSING ONLY - FROM BUILDING**
- OA-120 - FORMALIN DISPENSING ONLY - SELF CONTAINED**
- OA-121 - FORMALIN COLLECTION ONLY - TO BUILDING**
- OA-122 - FORMALIN COLLECTION ONLY - SELF CONTAINED**
- OA-163 - FORMALIN DISPENSING ONLY SYSTEM - CUBE STYLE**

PATHOLOGY GROSSING STATIONS

PEGBOARD OPTIONS & ACCESSORIES

Storage Containers
Stainless Steel

Magnetic Instrument Holder

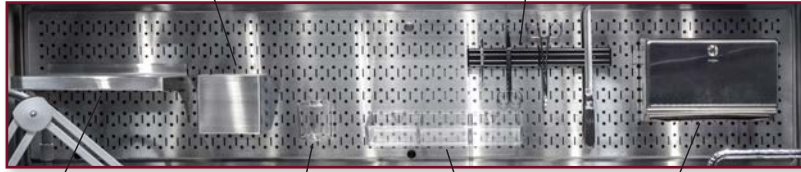

Shelf
Stainless Steel

3 in. Diameter Cup
Acrylic

3 Compartment Tray
Acrylic

C-Fold Paper Towel Holder
Stainless Steel



Grossing Station Personalization

Options based on available space

When planning an order, we will assist you in selecting options to complete your system. Feel free to contact your sales associate.

OA-170 - Pegboard Backsplash for GL100 or GL105

Slots accepts custom Mortech pegboard accessories only. Holes accept any off the shelf standard pegboard style items.

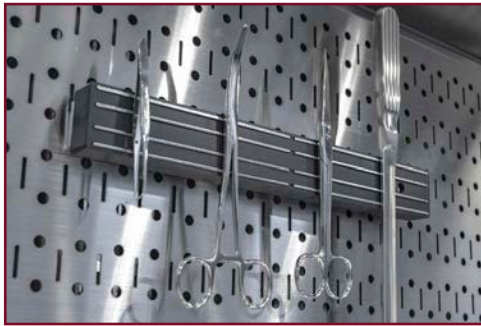

OA-170-1 - MAGNETIC INSTRUMENT HOLDER Conveniently store and organize your most commonly used instruments within arms reach.

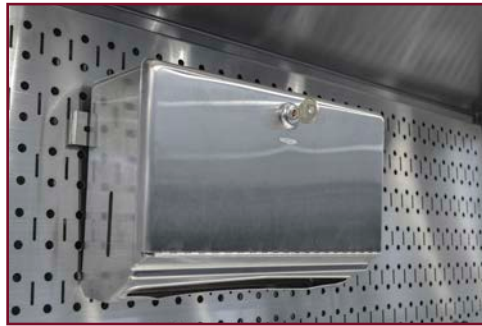

OA-170-2 - C-FOLD PAPER TOWEL HOLDER - ENCLOSED Stainless steel surface mounted towel dispenser.



OA-170-3 - C-FOLD PAPER TOWEL HOLDER - OPEN DESIGN Stainless Steel surface mounted towel dispenser with open design.



OA-170-4 & 170-5 - GLOVE BOX HOLDER Stainless Steel support to hold latex and nitrile glove box. Available in single & double box holders.



OA-170-6 - ADJUSTABLE STAINLESS STEEL SHELF All stainless steel construction adds storage space for accessories. 12 in. W x 7.5 in. L.



OA-170-7 - CASSETTE HOLDER - ACRYLIC Conveniently holds cassettes within arms reach. Removable boxes mount to pegboard on front of unit. Set of (3) boxes provided.



OA-170-8 - CASSETTE HOLDER - STAINLESS STEEL - SMALL Stainless steel storage container conveniently holds cassettes within arms reach. Removable boxes mount to pegboard on front of unit. 4 in. L x 3 3/4 in. H x 3 5/8 in. D.

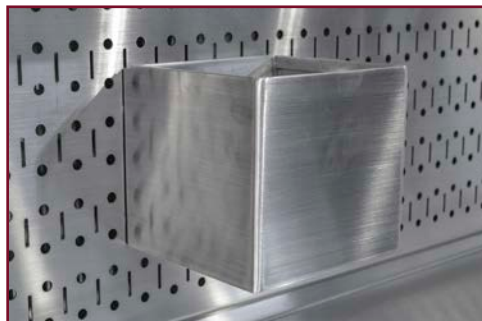

OA-170-9 - CASSETTE HOLDER - STAINLESS STEEL - LARGE Stainless steel storage container conveniently holds cassettes within arms reach. Removable boxes mount to pegboard on front of unit. 5 in. W x 4 3/4 in. H x 4 5/8 in. D.



OA-170-10 - ADJUSTABLE FORMS HOLDER - ACRYLIC For the storing of documents away from any fluids and risk of damage. Adjustable, to hold any media size. 2 in. W x 5 in. H x 1.5 in. D.

PATHOLOGY GROSSING STATIONS

PEGBOARD OPTIONS & ACCESSORIES

Pictured accessories may differ depending on your unit and other optional accessories. Not all accessories available for all models. Please review the model's standard features to ensure accuracy of specifications.



OA-170-11 - CLEAR CUP - ACRYLIC
Cup display for pegboards.
3 in. W x 3 in. H.

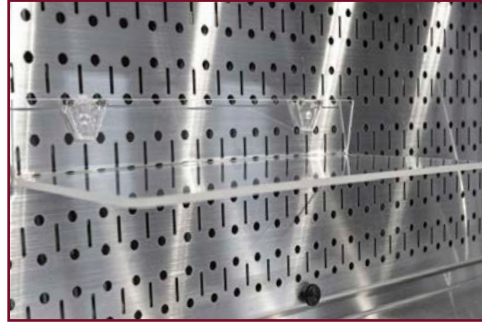

OA-170-12 - CLEAR SHELF - ACRYLIC
Clear Shelf and attached molded peg hooks for easy display.
13.5 in. W x 6 in. D.

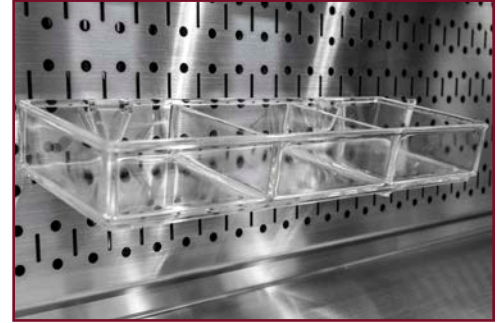

OA-170-13 - THREE COMPARTMENT CLEAR TRAY - ACRYLIC Molded tray with dividers, and attached molded peg hooks.
12.75 in. W x 1.75 in. H x 4.5 in. D.

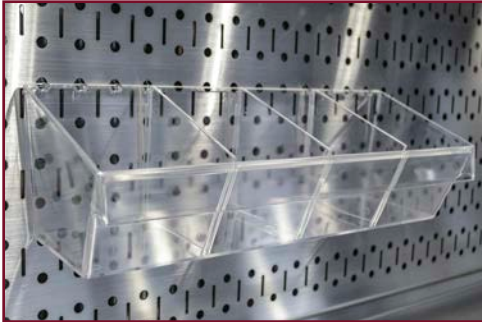

OA-170-14 - THREE COMPARTMENT CLEAR TRAY - ACRYLIC Designed for displaying multiple products of varying sizes at one time. Add included 4 in. dividers (qty. 3) to create more compartments.
13 in. W x 2.5 in. H x 4 in. D.

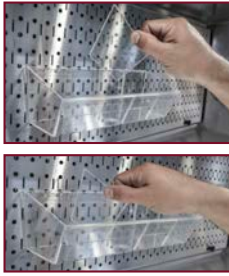

OA-170-15 - TWELVE COMPARTMENT CLEAR TRAY - ACRYLIC Multifunctional tray for pegboard or counter-top display. 12 separate compartments on 3 levels.
11.25 in. W x 9 in. H x 9 in. D.



OA-170-16 - 4 .IN SQUARE CLEAR BOX - ACRYLIC For the display and storage of accessories and small objects.
4 in. L x 4 in. H.

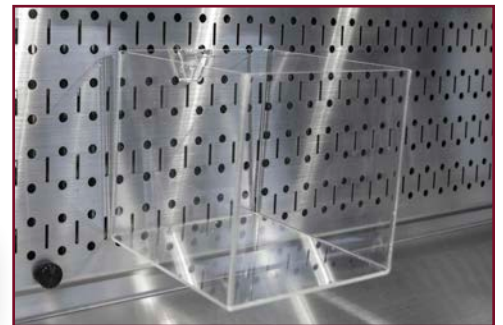

OA-170-17 - 6 .IN SQUARE CLEAR BOX - ACRYLIC For the display and storage of accessories and small objects.
6 in. L x 6 in. H.



PATHOLOGY GROSSING STATIONS

PEGBOARD OPTIONS & ACCESSORIES

Pictured accessories may differ depending on your unit and other optional accessories. Not all accessories available for all models. Please review the model's standard features to ensure accuracy of specifications.

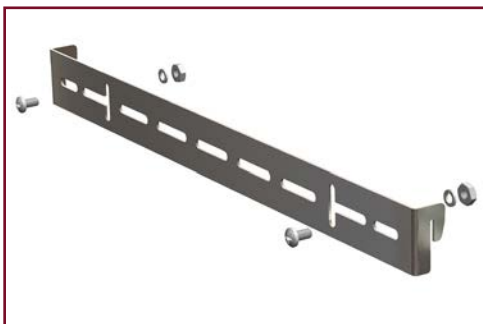

OA-170-18 - UNIVERSAL PEGBOARD MOUNTING BRACKET Provides the ability to mount any item to pegboard.



OA-154 - SHARPS DISPOSAL CONTAINER Pegboard mounted container for disposal of needles, syringes, and lancets, as well as other types of sharps and small quantities of medical waste.

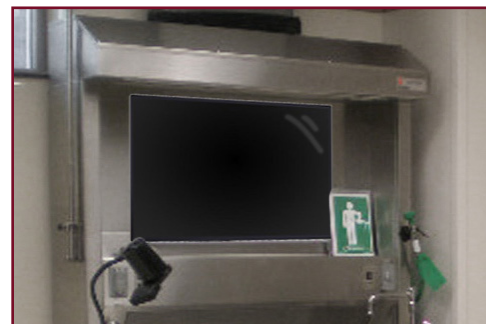

OA-139 - MONITOR PEGBOARD MOUNT Attach flat panel monitor directly to pegboard

Pegboard backplash removal procedure for cleaning purposes:



Fastening knobs (2) located at lower right & left



Unscrew knobs (2)

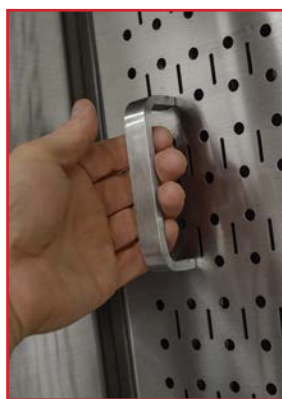

Using handles (2) located on right & left, lift & pull to remove backplash

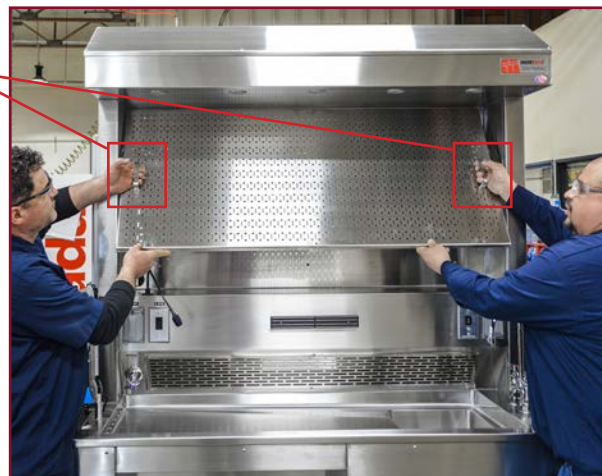

We recommend working with a partner when installing or removing backplash

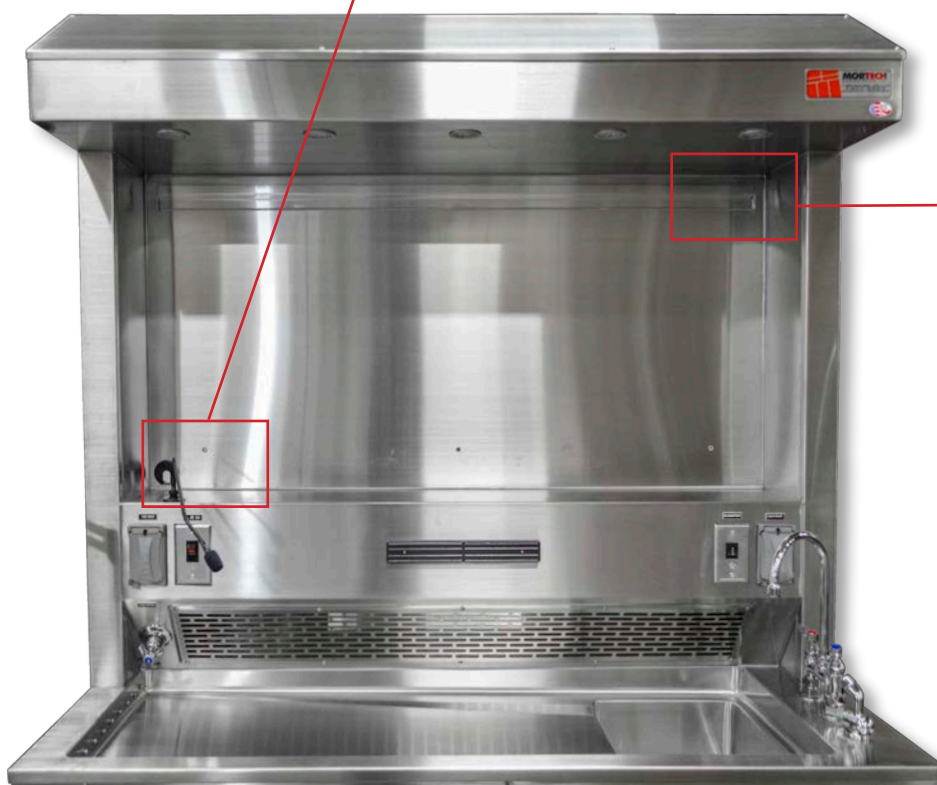

Mounting bracket located behind backplash secures pegboard to station

Grossing Station Personalization

Options based on available space

When planning an order, we will assist you in selecting options to complete your system. Feel free to contact your sales associate.

OA-170 - Pegboard Backplash for GL100 or GL105

Slots accepts custom Mortechn pegboard accessories only. Holes accept any of the shelf standard pegboard style items.