

Felt Tile Patch

DESIGN:

Vera & Kyte

Felt Tile is a modular system that you can design to fit perfectly into your space. Order a predefined set up, or design your own. We'll make sure you have everything you need to install it.

PRODUCT FEATURES:

Overlapping tiles and airgap between wall and product gives excellent sound absorption.

Hidden rail and adjustable ceiling attachments makes it easy to put up.

Plastic clips makes it easy to attach the tiles in your desired pattern and allows for the tiles to be rearranged later.

MATERIALS:

Really - acoustic textile felt, aluminum rail, steel wires and ceiling attachments.

PRODUCT INCLUDES:

Felt Tiles, Mounting rail with wires, ceiling attachments, screws and plastic clips.

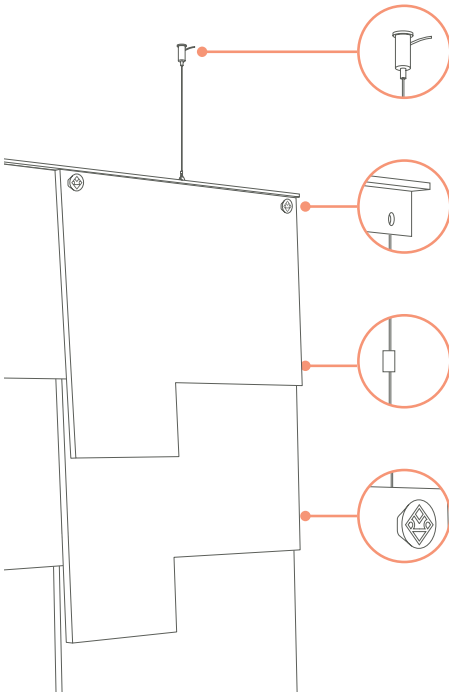

START WITH THE SUSPENSION

Mounting the rail

A: Measure out where you want the set up placed. The rail should be suspended from two attachment points in the ceiling.

Take note of where the wires are attached to the rail and the distance between them. Then mark the two points in the ceiling.

We advise you to place the attachment points at least 7 cm out from the wall, to increase the sound absorbing effect.

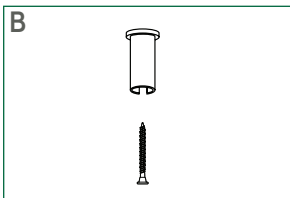
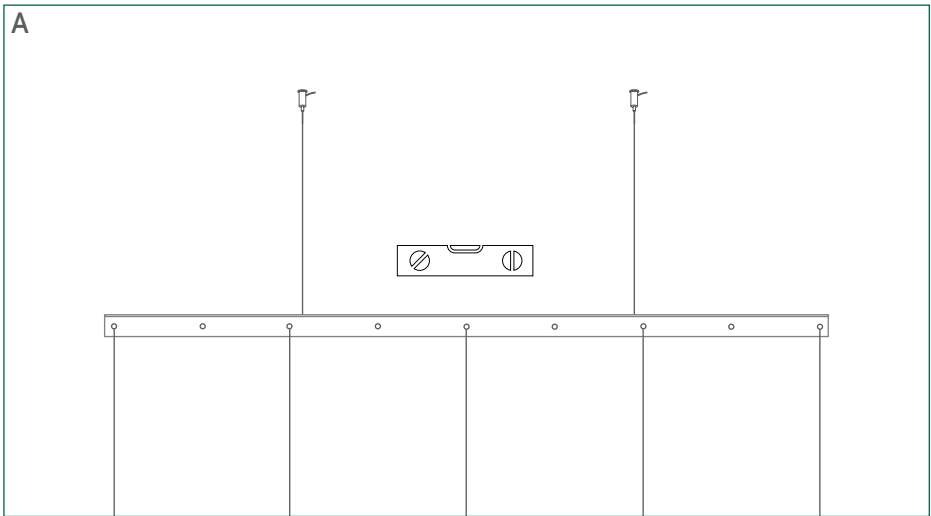

Screw the ceiling attachments to the ceiling at the marked positions.

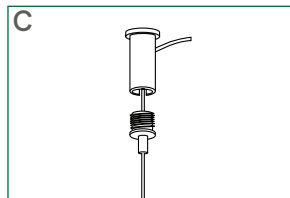

Pull the wire through the adjustable wire gripper, and screw it into the base by hand.

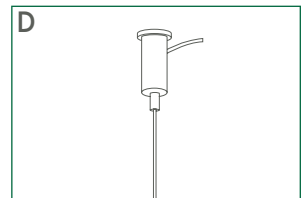

When both wires are attached, adjust the wires to the right height and make sure the rail is in level.

ATTACH THE FELT TILES

One row at a time.

Start at the bottom left. Mount one row at a time. Each row overlaps the row below to hide the clips.

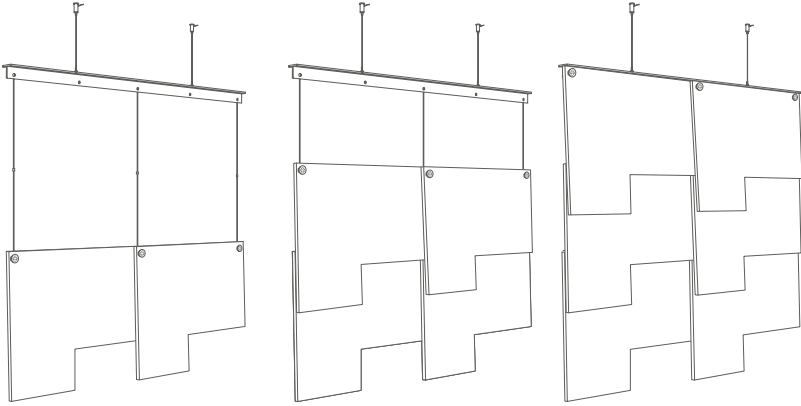

SINGLE LAYER: Use only short clips. The clips go through the tiles first and the wire last, so the wires show from the back.

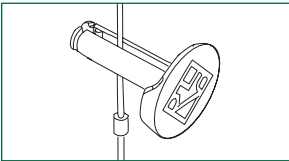

Slip clip on to the wire above the stopper.

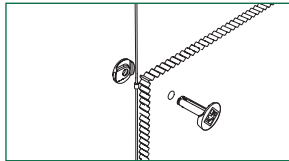

Attach the bottom left Tile first.

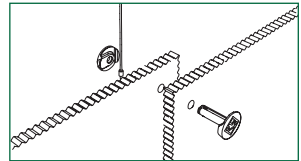

Place next tile on top of the previous one.

DOUBLE LAYER: The tiles are placed on both sides of the wires so the set up looks just as beautiful from the back and can be used as a room divider.

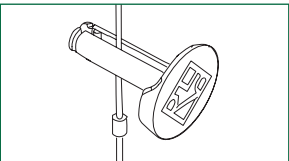

Slip clip on to the wire above the stopper.

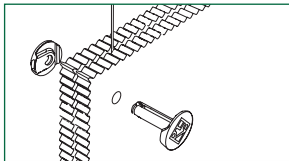

Use a short clip and attach the bottom left Tiles with the wire in the middle.

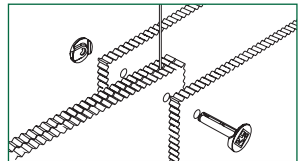

Next use a long clip and add two more tiles, one on each side of the two previous ones.



ROM & TONIK

GOOD LOOKING SOUND ABSORBERS